

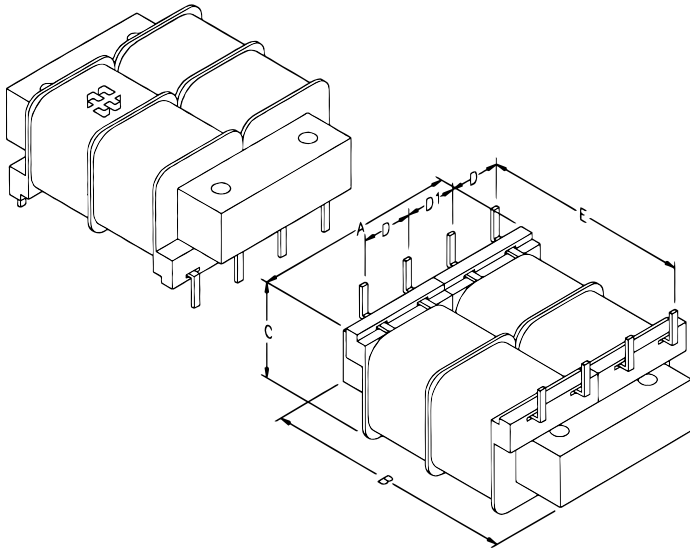

Power Transformer - Dual Primary Low Voltage PC Board Mount - Low Profile



Features

- Low profile mounting, dual - split bobbin design.
- Low primary to secondary coupling, balanced windings, no electrostatic shield required and low EMF radiation due to semi-toroidal design.
- Universal dual primary 115/230V - 50/60 Hz.
- High insulation - Hipot of 1,750V RMS.
- Class B insulation - 130 degrees C.
- C UL US recognized.

Connection Information - 229 Series Transformers

Mechanical	
A	2.50" (64 mm)
B	3.12" (79 mm)
C	1.38" (35 mm)
D	0.60" (15 mm)
D1	0.66" (17 mm)
E	2.18" (55 mm)
PC Board Spacing	1.50" (38 mm)
Pin Size	0.04" x 0.04" (1 mm x 1 mm)
Electrical	
Size (VA)	48
Primary	115 /230V, 50 /60Hz
Secondary (RMS) Series	16V C.T. @ 3A
Secondary (RMS) Parallel	8V @ 6A
Regulation	15%

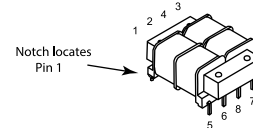

Primary Connections - 229 Series Transformers

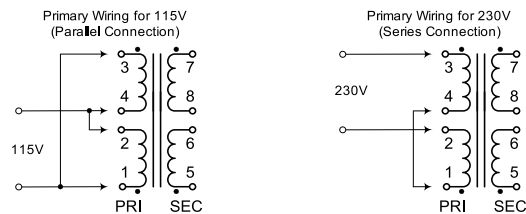

Secondary Connections - 229 Series Transformers

