

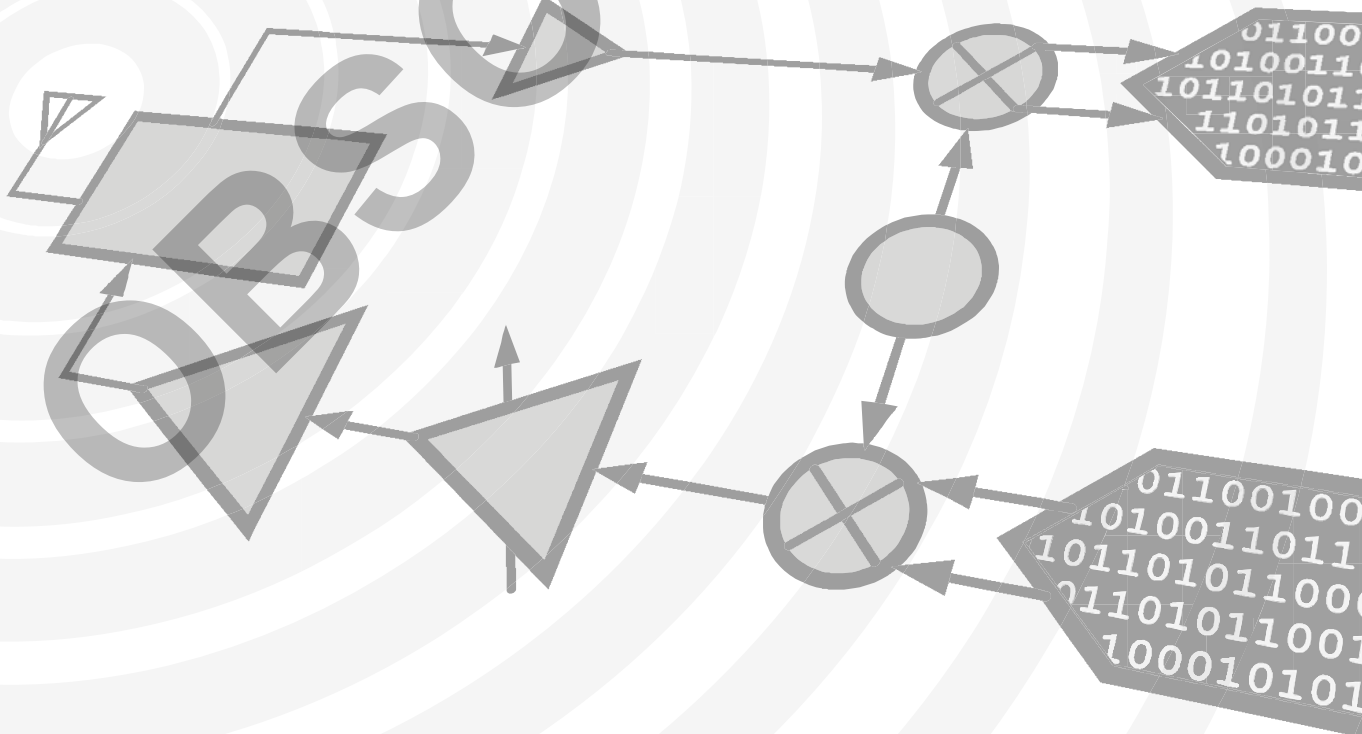

Hittite
MICROWAVE PRODUCTS
FROM ANALOG DEVICES

Analog Devices Welcomes Hittite Microwave Corporation

NO CONTENT ON THE ATTACHED DOCUMENT HAS CHANGED



THIS PAGE INTENTIONALLY LEFT BLANK

OBSOLETE

Typical Applications

The HMC207AS8 / HMC207AS8E is ideal for:

- Base Stations
- Cable Modems
- Portable Wireless

Features

- Conversion Loss: 9 dB
- LO / IF Isolation: 45 dB
- LO / RF Isolation: 40 dB
- Input IP3: +17 dBm

Functional Diagram

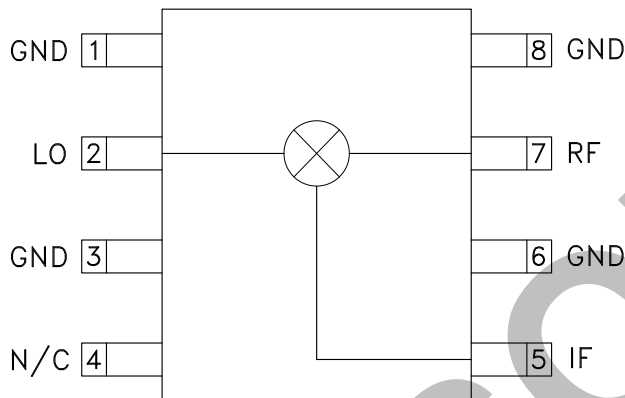

General Description

The HMC207AS8 & HMC207AS8E are miniature double-balanced mixers in 8 lead plastic surface mount Small Outline IC (SOIC) packages. This passive MMIC mixer is constructed of GaAs Schottky diodes and novel planar transformer baluns on the chip. The device can be used as an upconverter, downconverter, biphas modulator (de)modulator, or phase comparator. The consistent MMIC performance will improve system operation and assure regulatory compliance. The high LO suppression of 45 to 50 dB yields excellent carrier suppression for modulator applications.

Electrical Specifications, $T_A = +25^\circ \text{C}$, As a Function of LO Drive

Parameter	LO = +13 dBm IF = 70 MHz			LO = +10 dBm IF = 70 MHz			Units
	Min.	Typ.	Max.	Min.	Typ.	Max.	
Frequency Range, RF & LO	0.7 - 2.0			0.8 - 1.2			GHz
Frequency Range, IF	DC - 0.3			DC - 0.3			GHz
Conversion Loss		9	10.5		7.5	10	dB
Noise Figure (SSB)		9	10.5		7.5	10	dB
LO to RF Isolation	32	40		40	45		dB
LO to IF Isolation	38	45		40	45		dB
RF to IF Isolation	17	23		18	22		dB
IP3 (Input)	14	17		12	15		dBm
1 dB Gain Compression (Input)	8	11		7	10		dBm



GaAs MMIC SMT DOUBLE-BALANCED MIXER, 0.7 - 2.0 GHz

Conversion Loss vs Temperature @ LO = +13 dBm

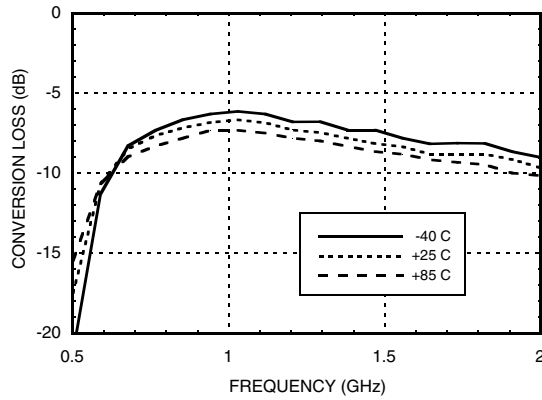

Isolation @ LO = +13 dBm

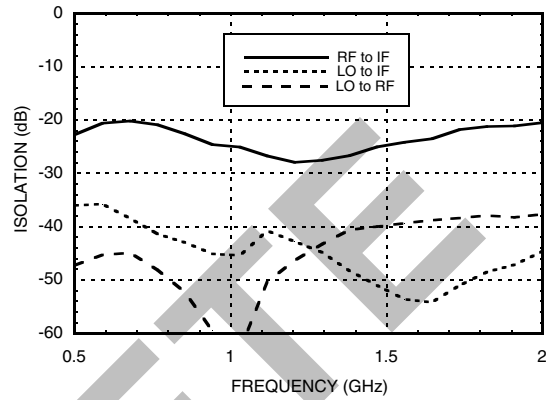

Conversion Loss vs. LO Drive

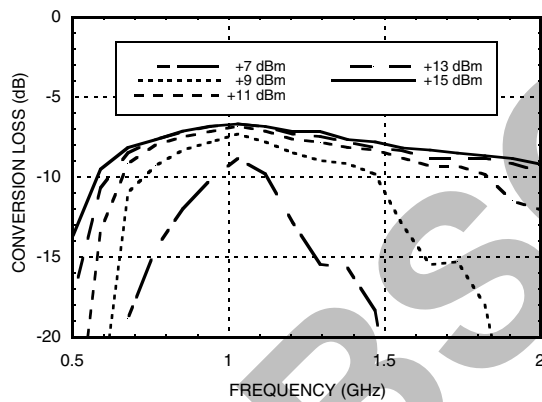

Return Loss @ LO = +13 dBm

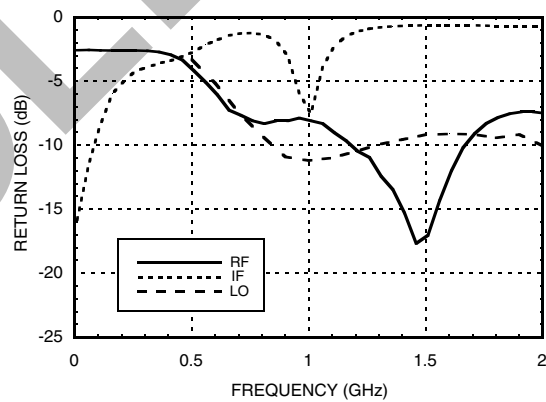

IF Bandwidth @ LO = +13 dBm

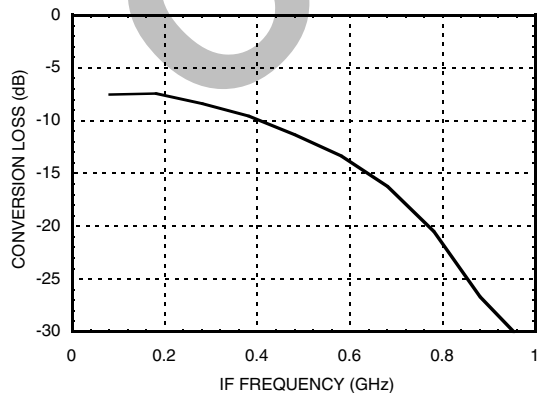

P1dB vs. Temperature @ LO = +13 dBm

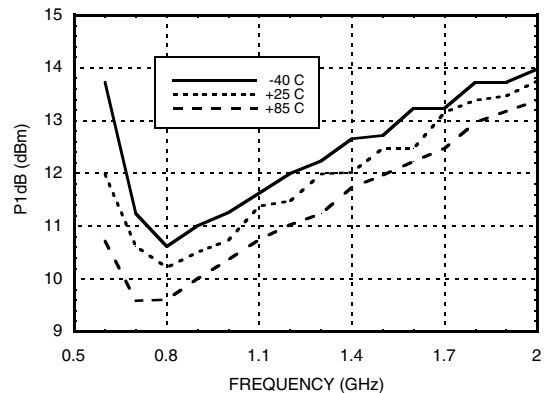



GaAs MMIC SMT DOUBLE-BALANCED MIXER, 0.7 - 2.0 GHz

Input IP3 vs. LO Drive

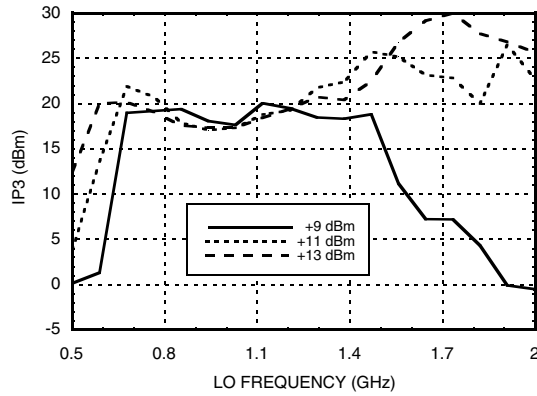

Input IP3 vs. Temperature @ LO = +13 dBm

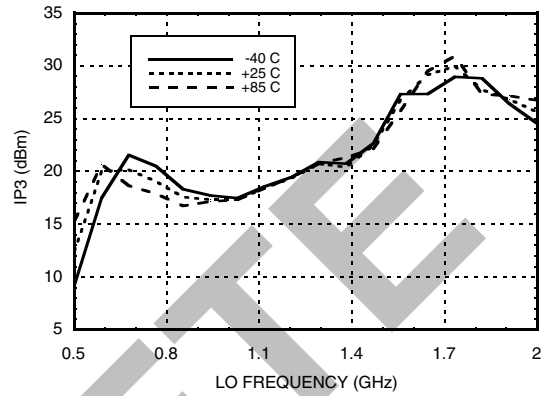

Input IP2 vs. LO Drive

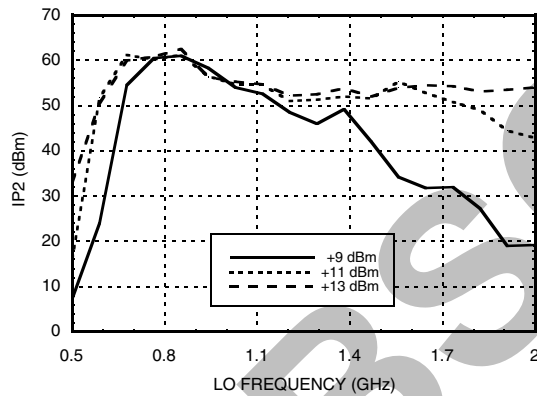

Input IP2 vs. Temperature @ LO = +13 dBm

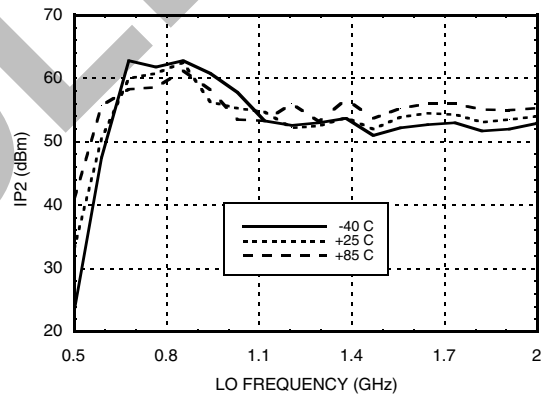

MxN Spurious Outputs

mRF	nLO				
	0	1	2	3	4
0	xx	14	27	22	44
1	16	0	46	45	46
2	68	62	67	69	73
3	89	92	91	65	86
4	>105	>105	>105	95	96

RF = 0.9 GHz @ -10 dBm
 LO = 0.97 GHz @ +13 dBm
 All values in dBc relative to the IF

Harmonics of LO



LO Freq. (GHz)	nLO Spur at RF Port			
	1	2	3	4
0.7	48	38	66	50
0.9	64	33	73	63
1.1	47	32	54	54
1.3	40	34	39	55
1.5	39	40	45	57
1.7	38	51	42	60

LO = +13 dBm
 Values in dBc below input LO level measured at RF Port.

GaAs MMIC SMT DOUBLE-BALANCED MIXER, 0.7 - 2.0 GHz
Absolute Maximum Ratings

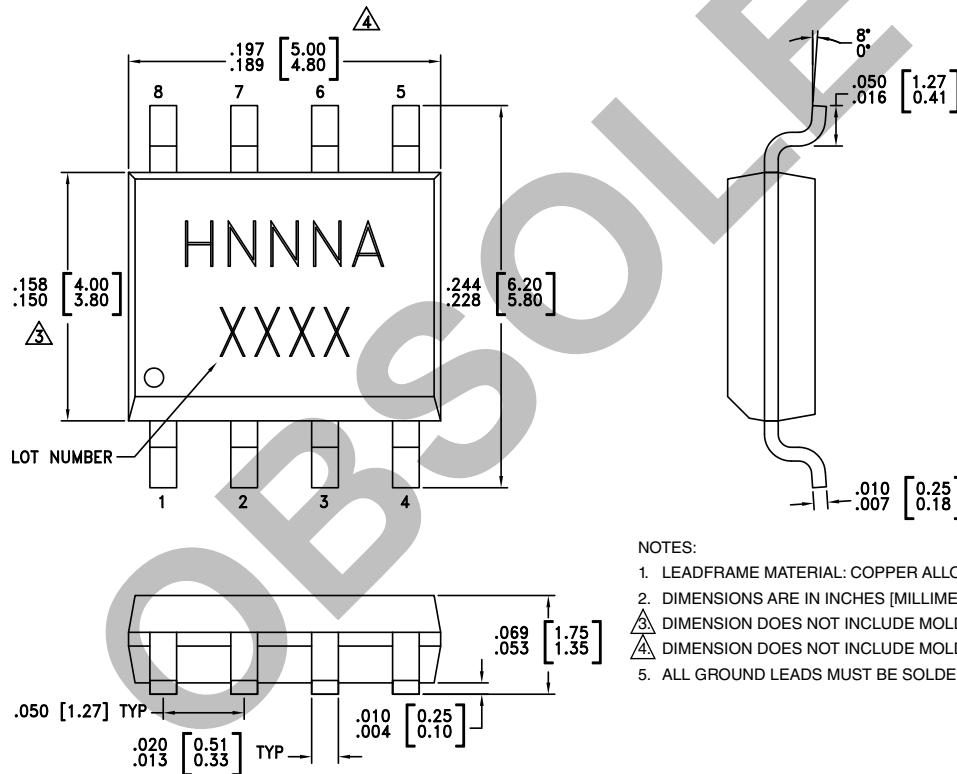
RF / IF Input	+13 dBm
LO Drive	+27 dBm
Storage Temperature	-65 to +150 °C
Operating Temperature	-40 to +85 °C
ESD Sensitivity (HBM)	Class 1A

**ELECTROSTATIC SENSITIVE DEVICE
OBSERVE HANDLING PRECAUTIONS**
Outline Drawing

NOTES:

- LEADFRAME MATERIAL: COPPER ALLOY
- DIMENSIONS ARE IN INCHES [MILLIMETERS].
-  DIMENSION DOES NOT INCLUDE MOLDFLASH OF 0.15mm PER SIDE.
-  DIMENSION DOES NOT INCLUDE MOLDFLASH OF 0.25mm PER SIDE.
- ALL GROUND LEADS MUST BE SOLDERED TO PCB RF GROUND.

Package Information

Part Number	Package Body Material	Lead Finish	MSL Rating	Package Marking ^[3]
HMC207AS8	Low Stress Injection Molded Plastic	Sn/Pb Solder	MSL1 ^[1]	H207A XXXX
HMC207AS8E	RoHS-compliant Low Stress Injection Molded Plastic	100% matte Sn	MSL1 ^[2]	H207A XXXX

[1] Max peak reflow temperature of 235 °C

[2] Max peak reflow temperature of 260 °C

[3] 4-Digit lot number XXXX

Pin Descriptions

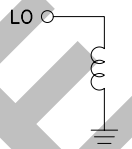
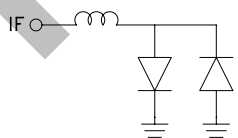
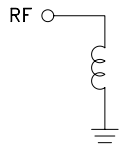
Pin Number	Function	Description	Interface Schematic
1, 3, 6, 8	GND	Package bottom must also be connected to RF/DC ground.	
2	LO	This pin is DC coupled and matched to 50 Ohm.	
4	N/C	No connection required. These pins may be connected to RF/DC ground without affecting performance.	
5	IF	This pin is DC coupled. For applications not requiring operation to DC, this port should be DC blocked externally using a series capacitor whose value has been chosen to pass the necessary IF frequency range. For operation to DC, this pin must not source or sink more than 10 mA of current or part non-function and possible part failure will result.	
8	RF	This pin is DC coupled and matched to 50 Ohm.	



GaAs MMIC SMT DOUBLE-BALANCED MIXER, 0.7 - 2.0 GHz

Evaluation PCB

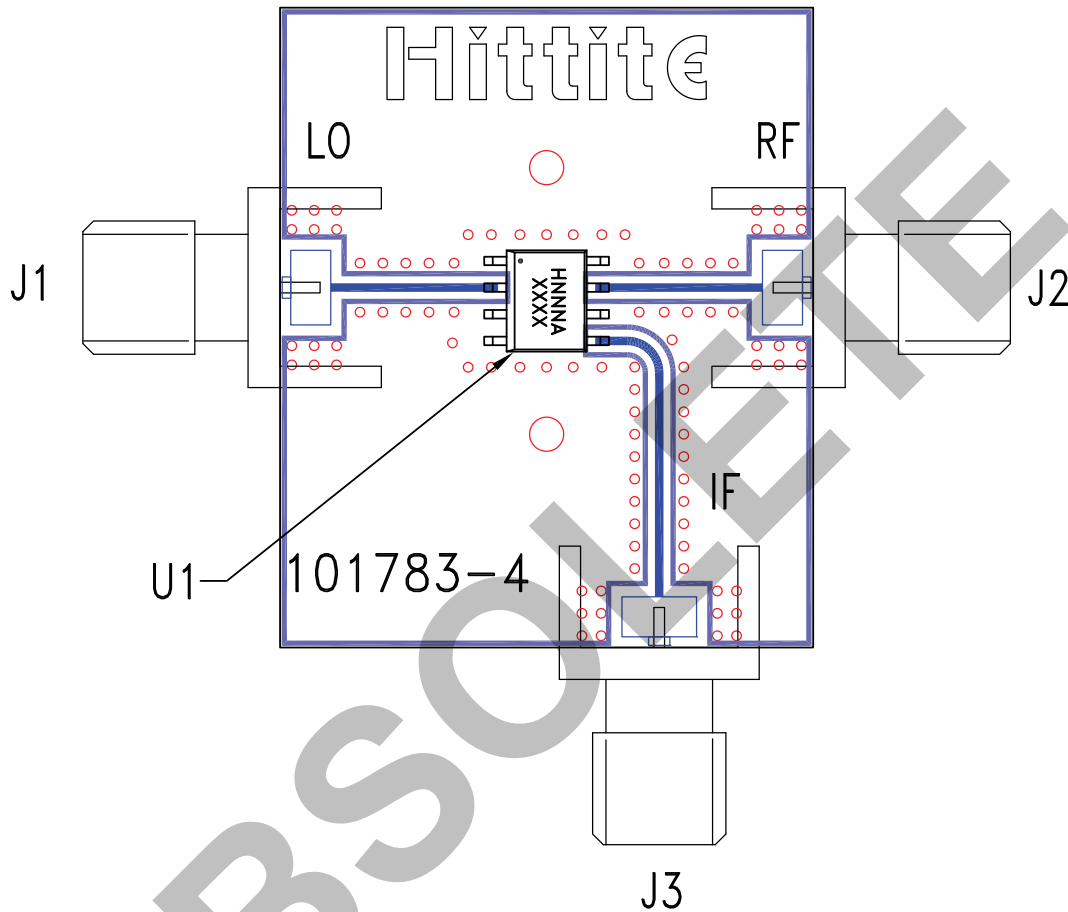

List of Materials for Evaluation PCB 101785 [1]

Item	Description
J1 - J3	PCB Mount SMA RF Connector
U1	HMC207AS8 / HMC207AS8E Mixer
PCB [2]	101783 Evaluation Board

[1] Reference this number when ordering complete evaluation PCB

[2] Circuit Board Material: Rogers 4350

The circuit board used in the application should use RF circuit design techniques. Signal lines should have 50 Ohm impedance while the package ground leads should be connected directly to the ground plane similar to that shown. A sufficient number of via holes should be used to connect the top and bottom ground planes. The evaluation circuit board shown is available from Hittite upon request.