

**WS418NKU** is an absorptive **SP4T RF switch module** that supports a frequency range from 10 kHz to 18 GHz. It delivers high isolation, low insertion loss and fast switching time, making this device ideal for RF signal routing in wireless infrastructure and wireless applications up to 18 GHz.

External connectors include 2.92mm-vertical launch connector for all RF port.

**WS418NKU** is powered and controlled through **USB3.0 connector**.



## ■ Features

- CMOS SOI technology enhanced
  - Broadband 10 kHz~18 GHz
  - Fast settling time
- High power handling of 32 dBm THRU path
- Insertion loss
  - 5.5 dB @ 18 GHz
- High isolation
  - 28 dB up to 18 GHz

## ■ Applications

- Test & Measurement
- 5G Wireless Communication
- Commercial Communication
- RF signal routing

**■ Electrical Specifications**

Parameter	Path	Condition	Min	Typ	Max	Unit
Operation Frequency			10 kHz		18 GHz	
Insertion loss	All path	10 kHz ~ 18 GHz		5.5		dB
Return loss (common port)	All path	10 kHz ~ 18 GHz	7.0	7.7		dB
Return loss (active port)	All path	10 kHz ~ 18 GHz	8.5	9.7		dB
Return loss (isolated port)	All path	10 kHz ~ 18 GHz	8.5	9.5		dB
Isolation	All path	10 kHz ~ 18 GHz	26.0	28.0		dB
RF Input Power	All path			32.0		dBm
0.1 dB Power Compression	All path	f = 26 MHz to 18 GHz		33.0		dBm
Input IP3	All path	10 MHz ~ 18 GHz		59.0		dBm
Current consumption		USB3.0		14.0		mA
Power Supply		USB3.0		5.0		V
Baud Rate		USB COM port		115200		bps
RF Connectors		2.92mm-female				
ESD HBM		RF port USB port		2.5k 16k		V
Operating Temperature			-40		85	°C

■ Typical Performance Data

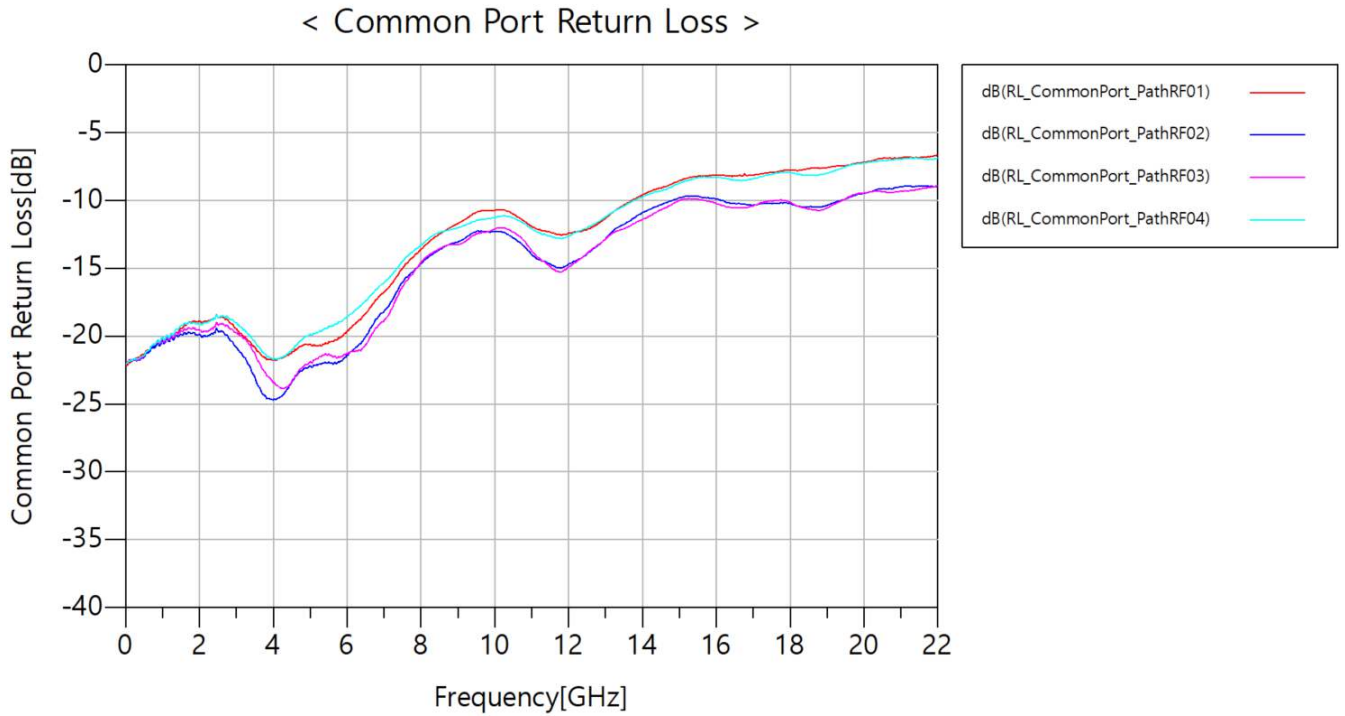
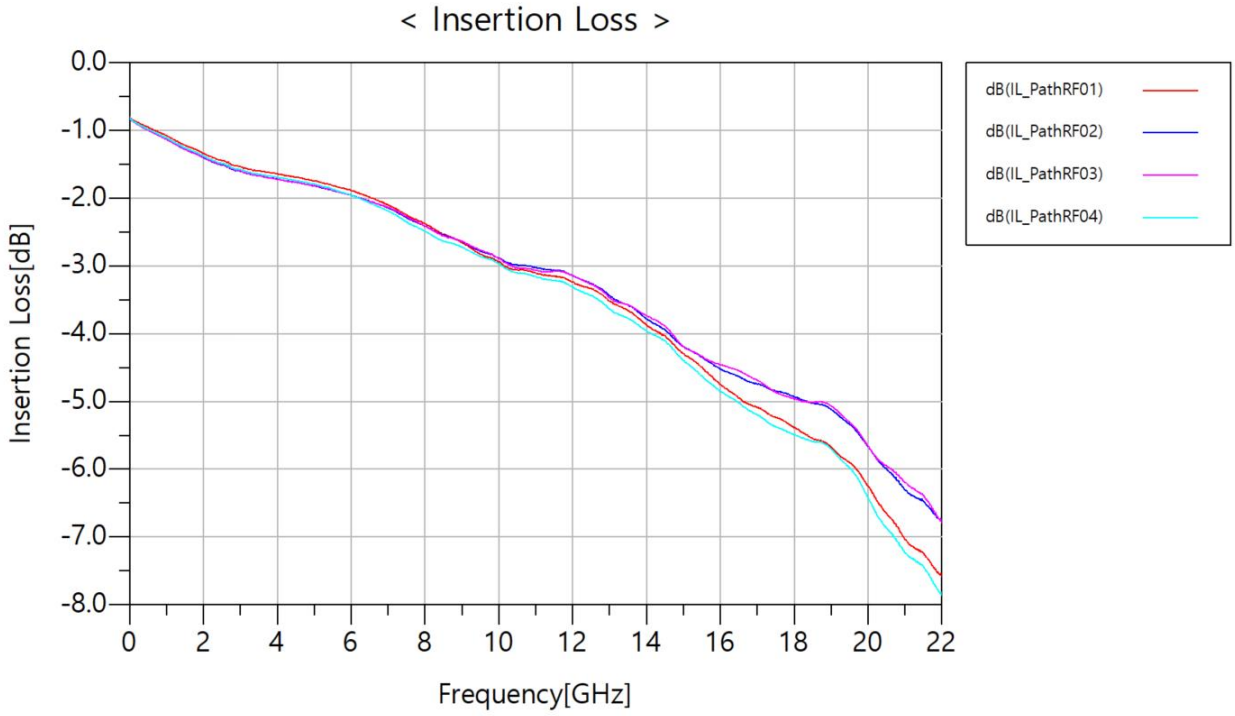

## ■ Typical Performance Data

< Active Port Return Loss >

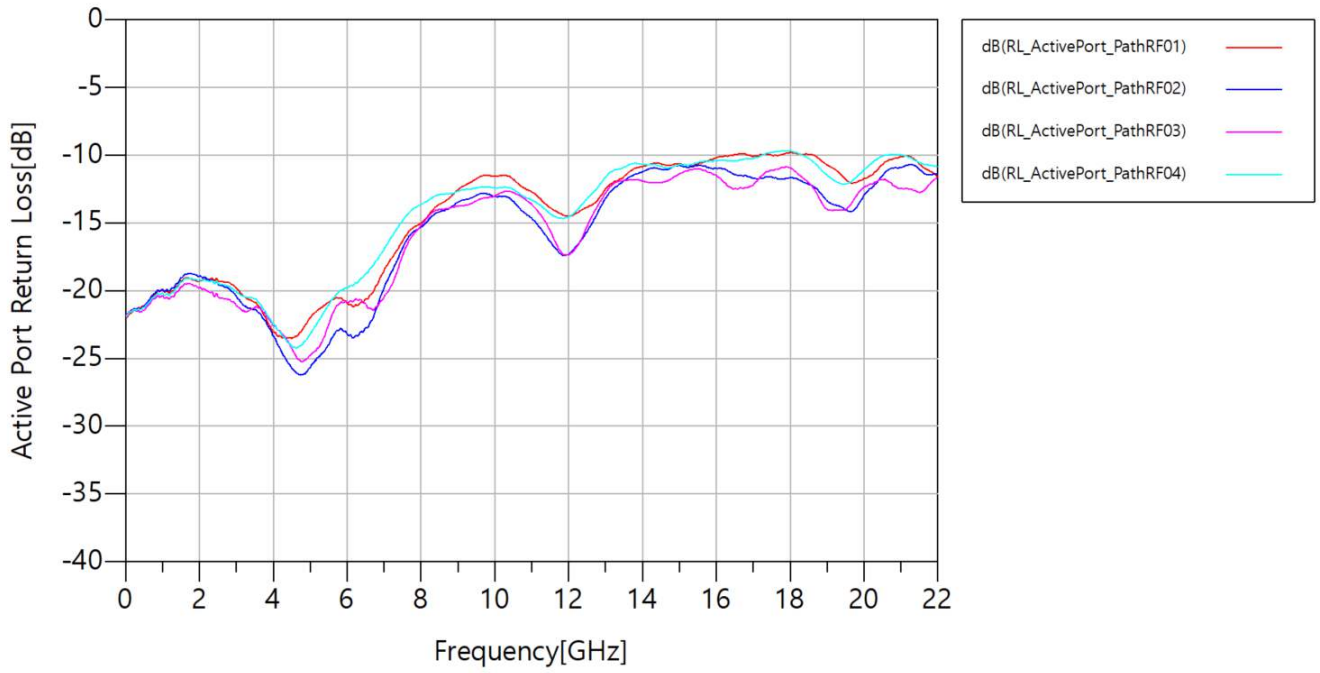

< Isolated Port Return Loss >

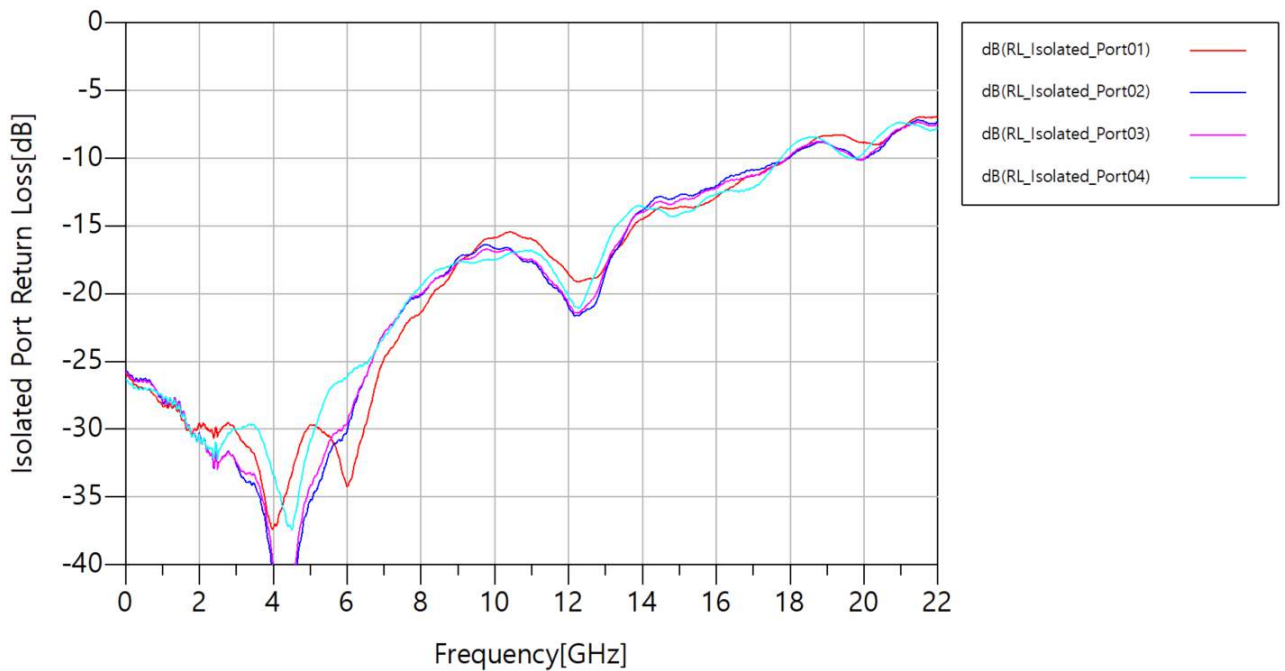

## Typical Performance Data

< RFC to RFx Isolation @ PathRF01 >

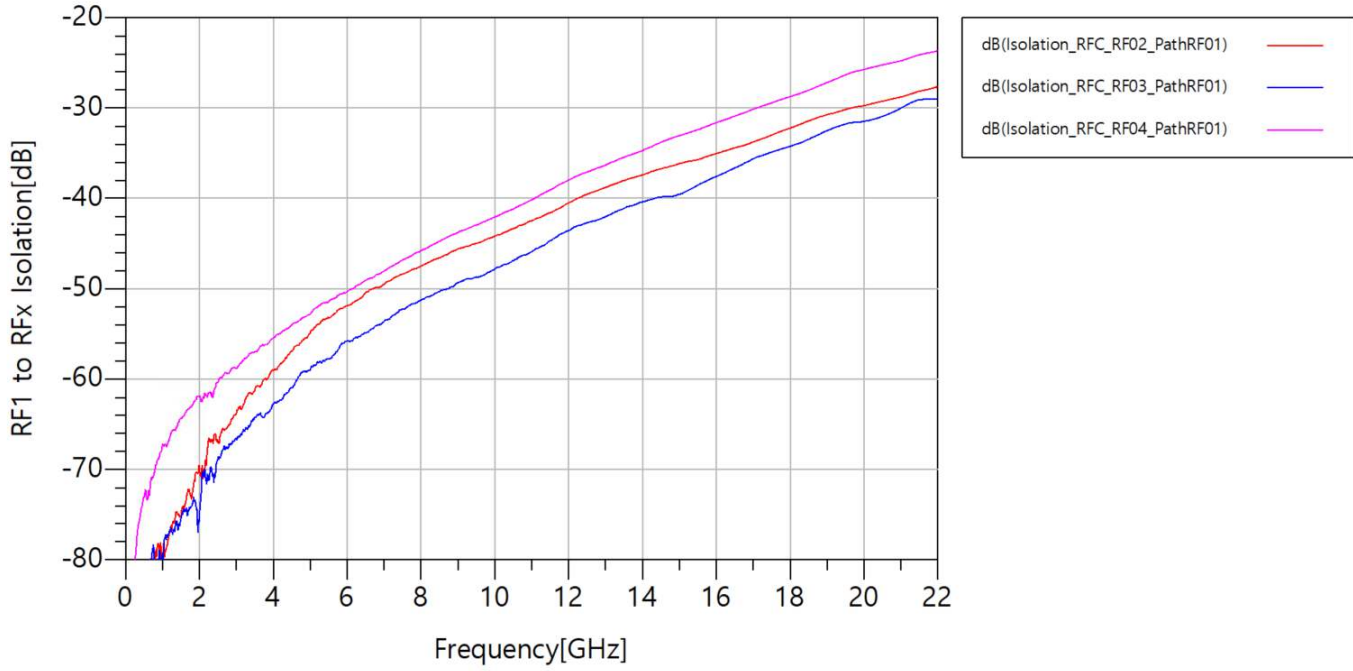

< RFC to RF01 Isolation @ PathRFx >

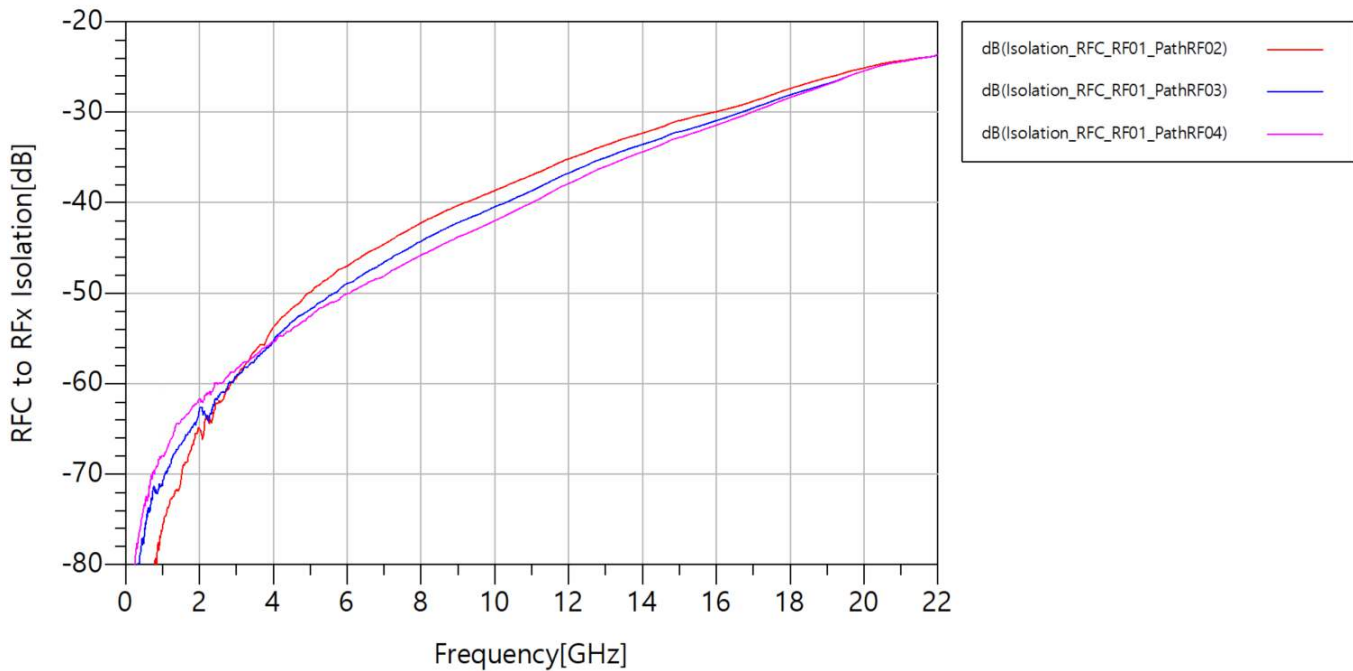

## ■ Dimension

Unit : mm

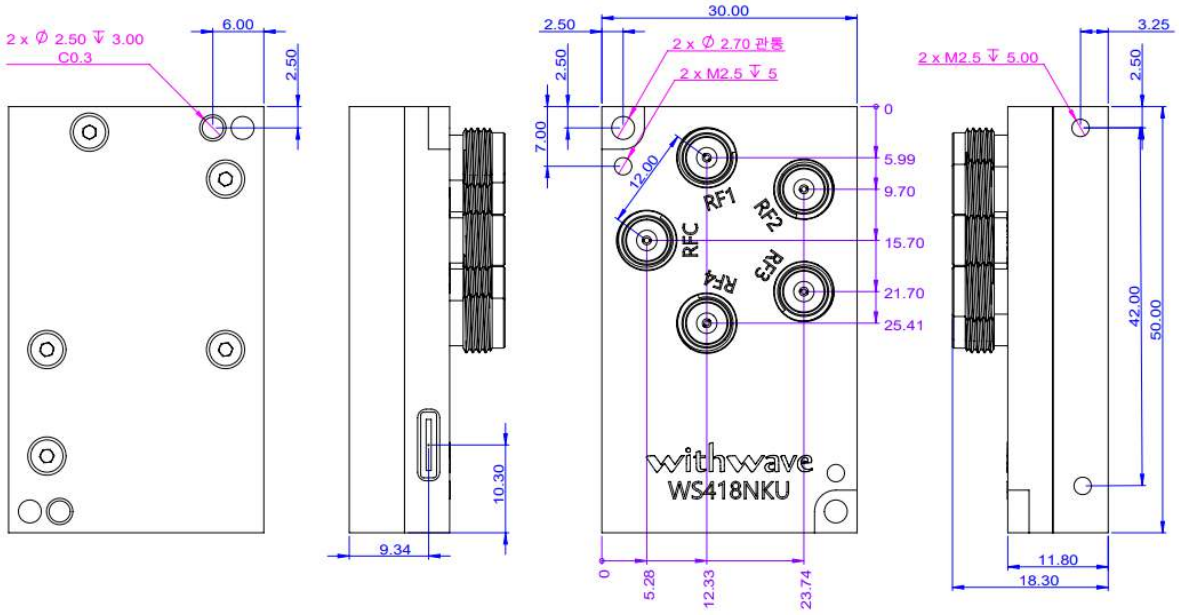

**Control Description**

Command Format	COM port configuration
All commands must end with a semicolon. All commands are capitalized only. Port number should be 2-digit decimal.	Baud Rate :115200 Data bits : 8 Parity : None Stop bits : 1 Flow Type :None

**Command Specification**

Index	Command	Description	Return	Example
1	*IDN?;	Query product information	Product PN ,Manufacturer , SW version	WS418NKU, Withwave co, Ltd., V1.0
2	RESET;	Reset the product	RESET;	RESET;
3	Pxx;	Switching to RFC to RFxx Port number should be 2-digit decimal	Pxx;	P02;
4	OFF;	All off state	OFF;	OFF;

**Error Code**

Index	Return	Description
1	E1;	Semicolon missing
2	E2;	Incorrect commands

■ **Revision History**

Revision	Date	Changes
Ver 1.0	2022-06-02	Initial work