

JRW017-070 Series Power Modules DC-DC Converters

36-75Vdc Input; 1.2Vdc to 12Vdc Output

RoHS Compliant



Applications

- Distributed power architectures
- Wireless Networks
- Optical and Access Network Equipment
- Enterprise Networks
- Latest generation IC's (DSP, FPGA, ASIC) and Microprocessor powered applications

Options

- Auto restart after fault protection shutdown
- Positive logic, Remote On/Off
- Case ground pin (-H Baseplate option)
- Active load sharing (Parallel Operation)

Description

The JRW series provide up to 70A output current in an industry standard half brick, which makes it an ideal choice for optimum space, high current and low voltage applications. The converter incorporates synchronous rectification technology and innovative packaging techniques to achieve high efficiency reaching 91% at 3.3V full load. The ultra high efficiency of this converter leads to lower power dissipation such that for most applications a heat sink is not required. The output is fully isolated from the input, allowing versatile polarity configurations and grounding connections. Built-in filtering for both input and output minimizes the need for external filtering.

Features

- Compliant to RoHS EU Directive 2011/65/EU (Z versions)
- Compliant to RoHS EU Directive 2011/65/EU under exemption 7b (Lead solder exemption). Exemption 7b will expire after June 1, 2016 at which time this product will no longer be RoHS compliant (non-Z versions)
- Delivers up to 70A Output current
- High efficiency – 91% at 3.3V full load
- Improved Thermal Performance:
42A at 70°C at 1m/s (200LFM) for 3.3V_o
- Low output voltage-supports migration to future IC supply voltages down to 1.0V
- Industry standard Half brick footprint
61.0mm x 58.4mm x 9.5mm
(2.40in x 2.30in x 0.38in)
- High power density and Low output ripple and noise
- 2:1 Input voltage range
- Constant switching frequency
- Output overcurrent/voltage/Overtemperature protection
- Single Tightly regulated output
- Remote sense
- Adjustable output voltage (+10%/ -20%)
- Negative logic, Remote On/Off
- Wide operating temperature range (-40°C to 85°C)
- Meets the voltage insulation requirements for ETSI 300-132-2 and complies with and is Licensed for Basic Insulation rating per EN 60950
- CE mark meets 73/23/EEC and 93/68/EEC directives[§]
- UL* 60950-1 Recognized, CSA† C22.2 No. 60950-1-03 Certified, and VDE‡ 0805:2001-12 (EN60950-1) Licensed
- ISO** 9001 certified manufacturing facilities

JRW017-070 Series Power Modules DC-DC Converters

36-75Vdc Input; 1.2Vdc to 12Vdc Output

Absolute Maximum Ratings

Stresses in excess of the absolute maximum ratings can cause permanent damage to the device. These are absolute stress ratings only, functional operation of the device is not implied at these or any other conditions in excess of those given in the operations sections of the data sheet. Exposure to absolute maximum ratings for extended periods can adversely affect the device reliability.

Parameter	Device	Symbol	Min	Max	Unit
Input Voltage					
Continuous	All	V_{IN}	-0.3	80	Vdc
Transient (100 ms)		$V_{IN,trans}$	-0.3	100	Vdc
Operating Ambient Temperature (see Thermal Considerations section)	All	T_A	-40	85	°C
Storage Temperature	All	T_{stg}	-55	125	°C
I/O Isolation	All			1500	Vdc

Electrical Specifications

Unless otherwise indicated, specifications apply over all operating input voltage, resistive load, and temperature conditions.

Parameter	Device	Symbol	Min	Typ	Max	Unit
Operating Input Voltage	All	V_{IN}	36	48	75	Vdc
Maximum Input Current ($V_{IN}=0$ to 75V, $I_o=I_{o,max}$)	All	$I_{IN,max}$			7	Adc
Inrush Transient	All	I^2t			1	A ² s
Input Reflected Ripple Current, peak-to-peak (5Hz to 20MHz, 12µH source impedance; $V_{IN}=0V$ to 75V, $I_o=I_{o,max}$; see Figure 31)	All		-	15	-	mAp-p
Input Ripple Rejection (120Hz)	All			60		dB

CAUTION: This power module is not internally fused. An input line fuse must always be used.

This power module can be used in a wide variety of applications, ranging from simple standalone operation to an integrated part of sophisticated power architecture. To preserve maximum flexibility, internal fusing is not included; however, to achieve maximum safety and system protection, always use an input line fuse. The safety agencies require a time-delay fuse with a maximum rating of 20A (see Safety Considerations section). Based on the information provided in this data sheet on inrush energy and maximum dc input current, the same type of fuse with a lower rating can be used. Refer to the fuse manufacturer's data sheet for further information.

JRW017-070 Series Power Modules DC-DC Converters
36-75Vdc Input; 1.2Vdc to 12Vdc Output

Electrical Specifications (continued)

Parameter	Device	Symbol	Min	Typ	Max	Unit
Output Voltage Set-point ($V_{IN}=V_{IN,nom}$, $I_O=I_{O,max}$, $T_{ref}=25^{\circ}C$)	P	$V_{O,set}$	1.18	1.20	1.22	Vdc
	M		1.47	1.50	1.52	Vdc
	Y		1.77	1.80	1.83	Vdc
	G		2.47	2.50	2.53	Vdc
	F		3.24	3.30	3.36	Vdc
	A		4.95	5.0	5.05	Vdc
	B		11.76	12.0	12.24	Vdc
Output Voltage (Over all operating input voltage, resistive load, and temperature conditions until end of life)	P	V_O	1.16	—	1.24	Vdc
	M		1.45	—	1.55	Vdc
	Y		1.75	—	1.85	Vdc
	G		2.42	—	2.58	Vdc
	F		3.20	—	3.40	Vdc
	A		4.85	—	5.15	Vdc
	B		11.64	—	12.36	Vdc
Output Regulation Line ($V_{IN} = V_{IN,min}$ to $V_{IN,max}$) Load ($I_O = I_{O,min}$ to $I_{O,max}$) Temperature ($T_A = -40^{\circ}C$ to $+85^{\circ}C$)			—	0.05	0.2	% $V_{O,nom}$
			—	0.05	0.2	% $V_{O,nom}$
			—	15	50	mV
Output Ripple and Noise on nominal output ($V_{IN}=V_{IN,nom}$ and $I_O = I_{O,min}$ to $I_{O,max}$, $C_{Out} = 1\mu F$ ceramic // $10\mu F$ Tantalum capacitor)						
	RMS (5Hz to 20MHz bandwidth)		—	—	40	mV _{rms}
Peak-to-Peak (5Hz to 20MHz bandwidth)			—	—	100	mV _{pk-pk}
External Capacitance	P,M,Y,G,F	$C_{Out,ext}$	—	—	30,000	μF
	A,B	$C_{Out,ext}$	—	—	10,000	μF
Output Current	P,M	I_O	0	—	70	A
	G,Y		0	—	65	A
	F		0	—	60	A
	A		0	—	40	A
	B		0	—	17	A
Output Current Limit Inception	P,M	$I_{O,cli}$	—	80	—	A
	G,Y		—	73	—	A
	F		—	64	—	A
	A		—	50	—	A
	B		—	21	—	A
Output Short-Circuit Current $V_O \leq 250$ mV @ $25^{\circ}C$	All		—	Latched-off		

JRW017-070 Series Power Modules DC-DC Converters
36-75Vdc Input; 1.2Vdc to 12Vdc Output

Electrical Specifications (continued)

Parameter	Device	Symbol	Min	Typ	Max	Unit	
Efficiency ($V_{IN}=V_{IN,nom}$, $I_o=I_{o,max}$, $V_o=V_{o,set}$ $T_A=25^\circ\text{C}$)	P	η	—	84	—	%	
	M		—	86	—	%	
	Y		—	87	—	%	
	G		—	90	—	%	
	F		—	91	—	%	
	A		—	92	—	%	
	B		—	92	—	%	
Switching Frequency		f_{sw}	—	300	—	kHz	
Dynamic Load Response ($\Delta I_o/\Delta t=1\text{A}/10\mu\text{s}$; $V_{in}=V_{in,nom}$; $T_A=25^\circ\text{C}$; Tested with a 10 μF aluminum and a 1.0 μF tantalum capacitor across the load.) Load Change from $I_o= 50\%$ to 75% of $I_{o,max}$: Peak Deviation Settling Time ($V_o<10\%$ peak deviation) Load Change from $I_o= 75\%$ to 50% of $I_{o,max}$: Peak Deviation Settling Time ($V_o<10\%$ peak deviation)	P,M,Y,G	V_{pk}	—	6	—	$\%V_{o,set}$	
		t_s	—	300	—	μs	
		F,A	V_{pk}	—	4	—	$\%V_{o,set}$
			t_s	—	300	—	μs
	B	V_{pk}	—	3	—	$\%V_{o,set}$	
		t_s	—	500	—	μs	
	P,M,Y,G	V_{pk}	—	6	—	$\%V_{o,set}$	
		t_s	—	300	—	μs	
		F,A	V_{pk}	—	4	—	$\%V_{o,set}$
			t_s	—	300	—	μs
	B	V_{pk}	—	3	—	$\%V_{o,set}$	
		t_s	—	500	—	μs	

Isolation Specifications

Parameter	Symbol	Min	Typ	Max	Unit
Isolation Capacitance	C_{iso}	—	2700	—	pF
Isolation Resistance	R_{iso}	10	—	—	M Ω

General Specifications

Parameter	Min	Typ	Max	Unit
Calculated MTBF ($I_o= 80\%$ of $I_{o,max}$, $T_A=40^\circ\text{C}$, airflow=1m/s (400LFM))		1,363,000		Hours
Weight	—	60.3 (2.1)	—	g (oz.)

JRW017-070 Series Power Modules DC-DC Converters

36-75Vdc Input; 1.2Vdc to 12Vdc Output

Feature Specifications

Unless otherwise indicated, specifications apply over all operating input voltage, resistive load, and temperature conditions. See Feature Descriptions for additional information.

Parameter	Device	Symbol	Min	Typ	Max	Unit
Remote On/Off Signal interface ($V_i = V_{i,min}$ to $V_{i,max}$; Open collector or equivalent Compatible, signal referenced to V_i (-) terminal) Negative Logic: device code suffix "1" Logic Low=module On, Logic High=Module Off Positive Logic: No device code suffix required Logic Low=module Off, Logic High=Module On Logic Low Specification Remote On/Off Current-Logic Low	All	$I_{on/off}$	—	0.15	1.0	mA
On/Off Voltage: Logic Low	All	$V_{on/off}$	0.0	—	1.2	V
Logic High (Typ=Open Collector)	All	$V_{on/off}$	—	—	15	V
Logic High maximum allowable leakage current	All	$I_{on/off}$	—	—	50	μ A
Turn-On Delay and Rise Times ($I_o = I_{o,max}$) T_{delay} = Time until $V_o = 10\%$ of $V_{o,set}$ from either application of V_{in} with Remote On/Off set to On or operation of Remote On/Off from Off to On with V_{in} already applied for at least one second. T_{rise} = time for V_o to rise from 10% of $V_{o,set}$ to 90% of $V_{o,set}$.	P M Y G F A B P M Y G F A B	T_{delay} T_{rise}	— — — — — — — — — — — — — —	2 2 2 5 2 2.5 2.5 1 1 1 3 1 1 1	— — — — — — — — — — — — — —	msec msec msec msec msec msec msec msec msec msec msec msec msec msec
Output voltage adjustment range (TRIM) Output Voltage Remote sense range Output Voltage Set-point Adjustment range		V_{sense}	— 80	— —	10 110	% $V_{o,nom}$ % $V_{o,nom}$
Output Over voltage protection	P M Y G F A B	V_{Oovsd}	1.4 1.8 2.3 2.9 3.8 5.7 14	— — — — — — —	1.6 2.2 2.6 3.4 4.6 6.5 16	Vdc Vdc Vdc Vdc Vdc Vdc Vdc
Over temperature Protection	All	T_{ref}	—	127	—	$^{\circ}$ C
Input Undervoltage Lockout Turn-on Threshold Turn-off Threshold		$V_{in,OVLO}$	— 30	34.5 32.5	36 —	V V

JRW017-070 Series Power Modules DC-DC Converters

36-75Vdc Input; 1.2Vdc to 12Vdc Output

Characteristic Curves

The following figures provide typical characteristics for the JRW017A0B1 (12V, 17A) at 25°C. The figures are identical for either positive or negative Remote On/Off logic.

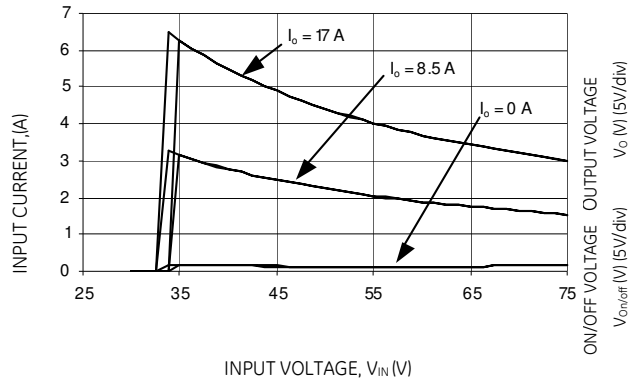

Figure 1. Typical Start-Up (Input Current) characteristics at room temperature.

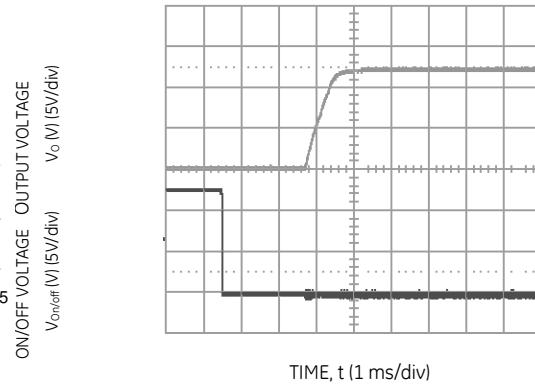

Figure 4. Typical Start-Up Characteristics from Remote ON/OFF.

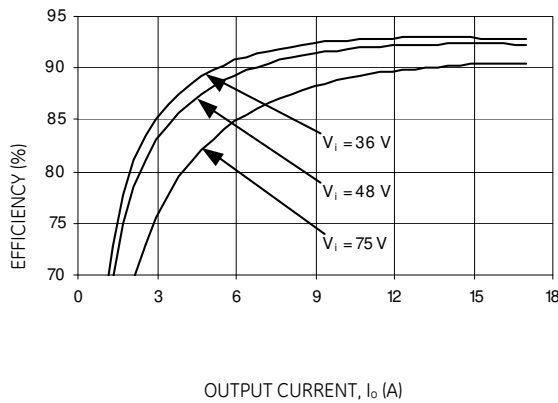

Figure 2. Converter Efficiency Vs Load at Room temperature.

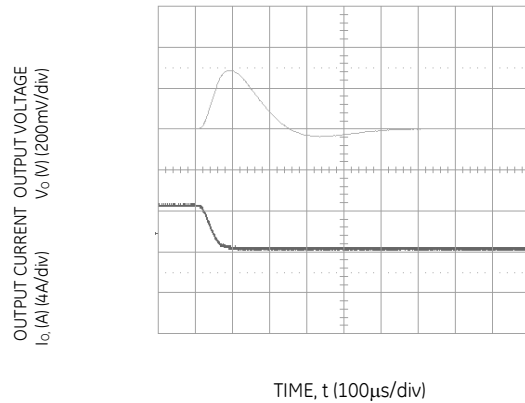

Figure 5. Transient Response to Dynamic Load Change from 50% to 25% of full load current.

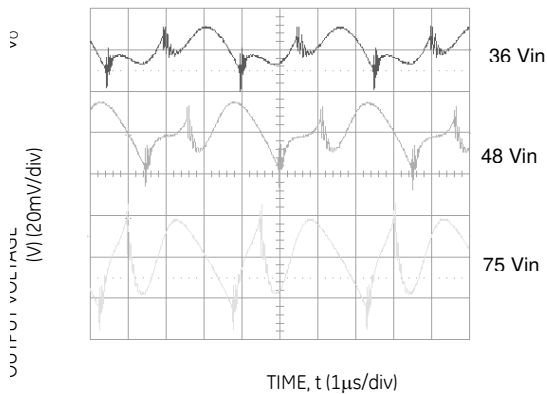

Figure 3. Typical Output Ripple and Noise at Room temperature and $I_o = I_{o,max}$.

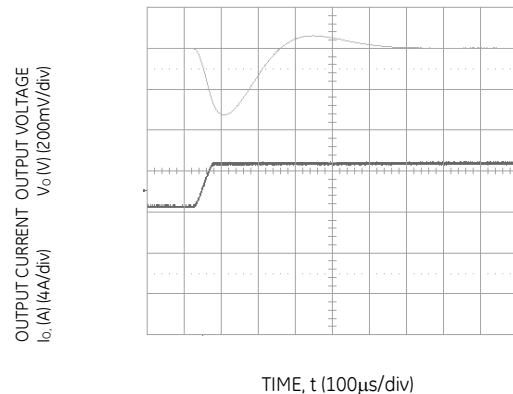

Figure 6. Transient Response to Dynamic Load Change from 50% to 75 % of full load current.

JRW017-070 Series Power Modules DC-DC Converters

36-75Vdc Input; 1.2Vdc to 12Vdc Output

Characteristic Curves (continued)

The following figures provide typical characteristics for the JRW040A0A (5V, 40A) at 25°C. The figures are identical for either positive or negative Remote On/Off logic.

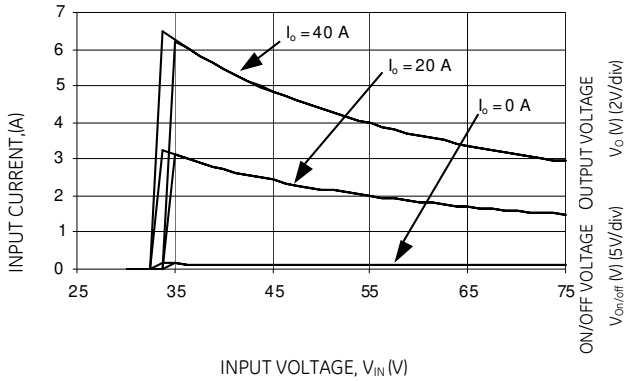

Figure 7. Typical Start-Up (Input Current) characteristics at room temperature.

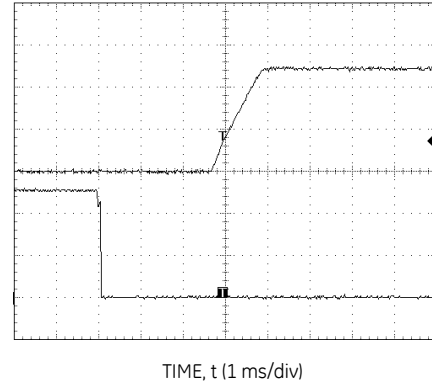

Figure 10. Typical Start-Up Characteristics from Remote ON/OFF.

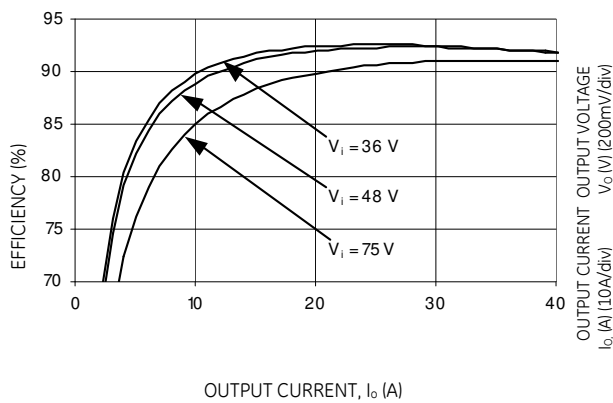

Figure 8. Converter Efficiency Vs Load at Room temperature.

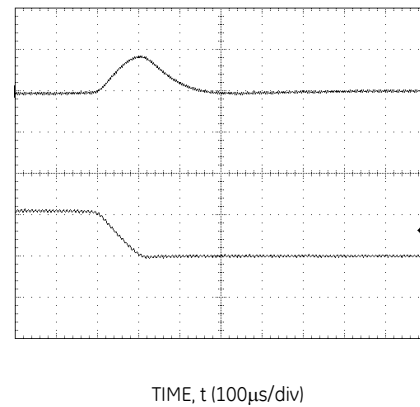

Figure 11. Transient Response to Dynamic Load Change from 50% to 25% of full load current.

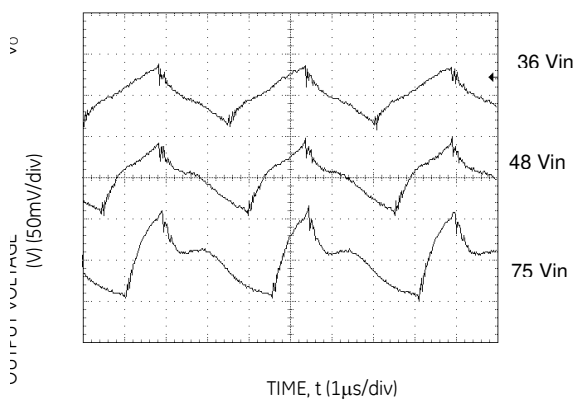

Figure 9. Typical Output Ripple and Noise at Room temperature and $I_o = I_{o,max}$.

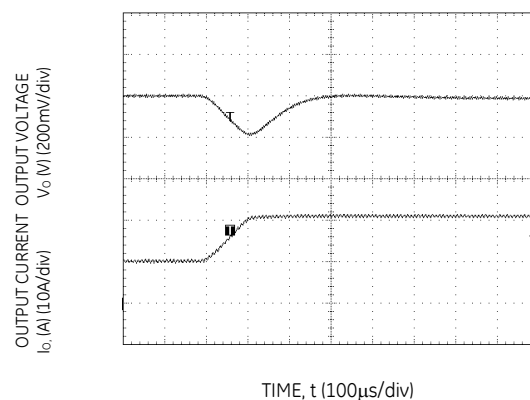

Figure 12. Transient Response to Dynamic Load Change from 25% to 50% of full load current.

JRW017-070 Series Power Modules DC-DC Converters

36-75Vdc Input; 1.2Vdc to 12Vdc Output

Characteristic Curves (continued)

The following figures provide typical characteristics for the JRW060A0F (3.3V, 60A) at 25°C. The figures are identical for either positive or negative Remote On/Off logic.

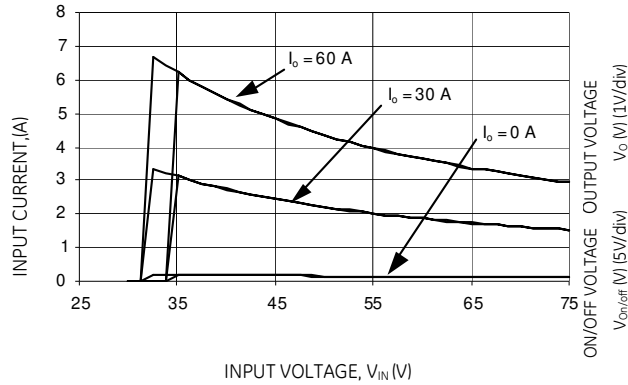

Figure 13. Typical Start-Up (Input Current) characteristics at room temperature.

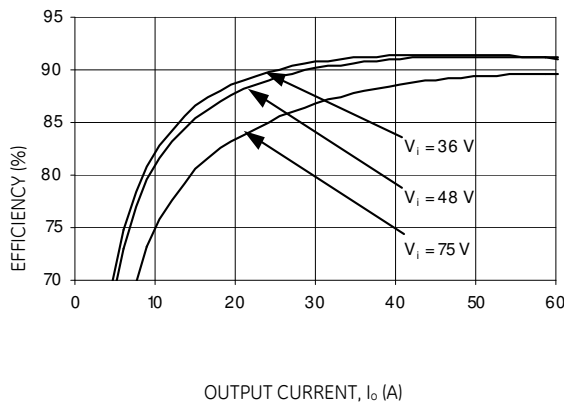

Figure 14. Converter Efficiency Vs Load at Room temperature.

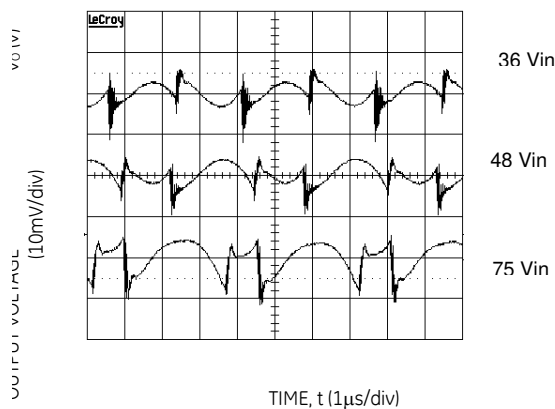

Figure 15. Typical Output Ripple and Noise at Room temperature and $I_o = I_{o,max}$.

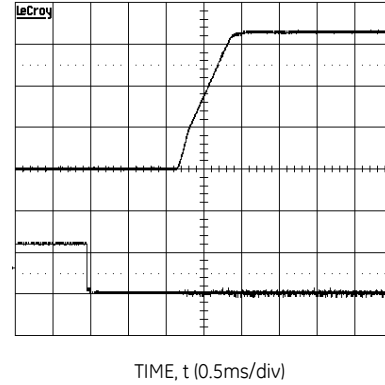

Figure 16. Typical Start-Up Characteristics from Remote ON/OFF.

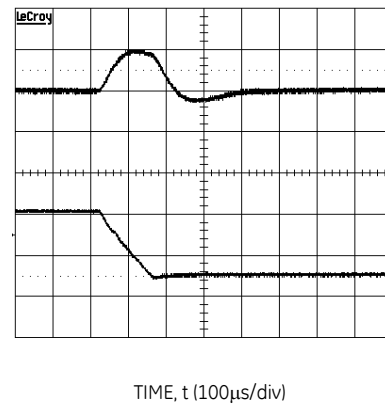

Figure 17. Transient Response to Dynamic Load Change from 50% to 25% of full load current.

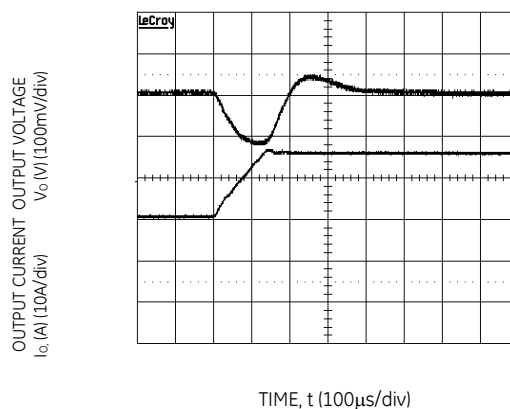

Figure 18. Transient Response to Dynamic Load Change from 50% to 75% of full load current.

JRW017-070 Series Power Modules DC-DC Converters

36-75Vdc Input; 1.2Vdc to 12Vdc Output

Characteristic Curves (continued)

The following figures provide typical characteristics for the JRW065A0G (2.5V, 65A) at 25°C. The figures are identical for either positive or negative Remote On/Off logic.

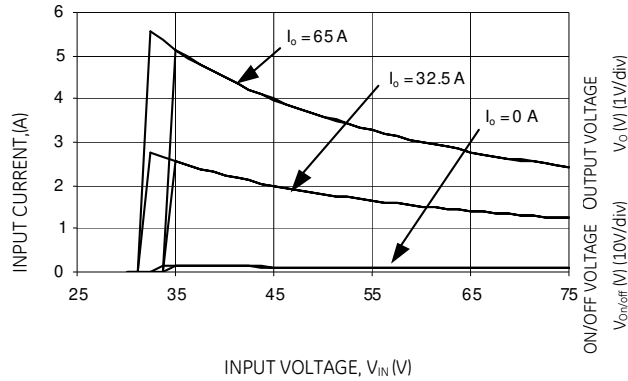

Figure 19. Typical Start-Up (Input Current) characteristics at room temperature.

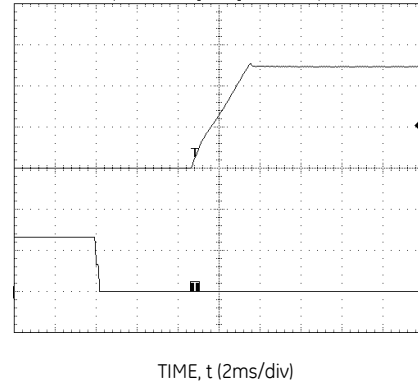

Figure 22. Typical Start-Up Characteristics from Remote ON/OFF.

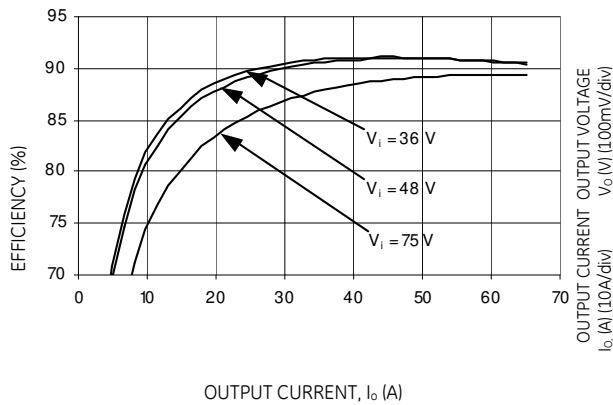

Figure 20. Converter Efficiency Vs Load at Room temperature.

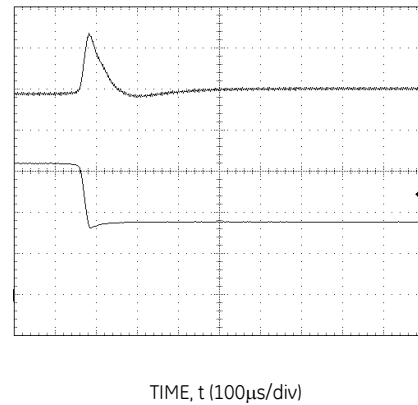

Figure 23. Transient Response to Dynamic Load Change from 50% to 25% of full load current.

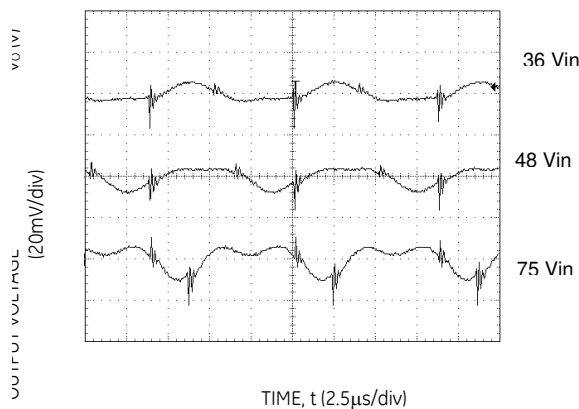

Figure 21. Typical Output Ripple and Noise at Room temperature and $I_o = I_{o,max}$.

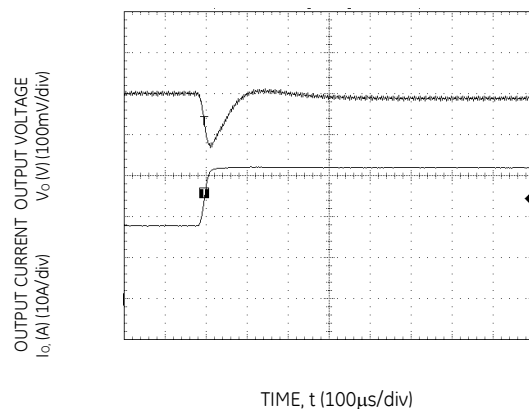

Figure 24. Transient Response to Dynamic Load Change from 25% to 50% of full load current.

JRW017-070 Series Power Modules DC-DC Converters

36-75Vdc Input; 1.2Vdc to 12Vdc Output

Characteristic Curves (continued)

The following figures provide typical characteristics for the JRW065A0Y (1.8V, 65A) at 25°C. The figures are identical for either positive or negative Remote On/Off logic.

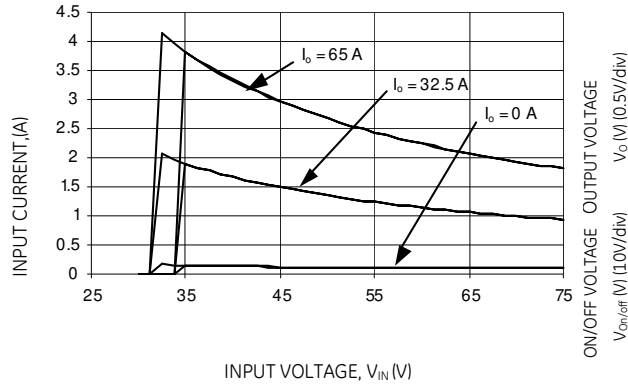

Figure 25. Typical Start-Up (Input Current) characteristics at room temperature.

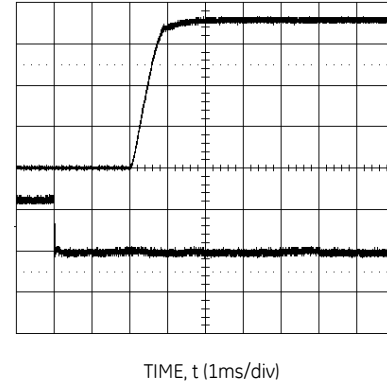

Figure 28. Typical Start-Up Characteristics from Remote ON/OFF.

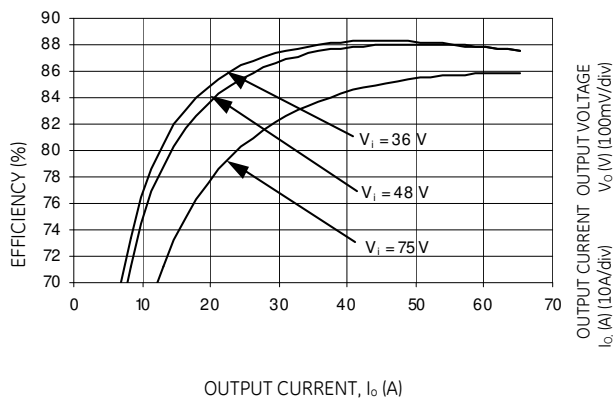

Figure 26. Converter Efficiency Vs Load at Room temperature.

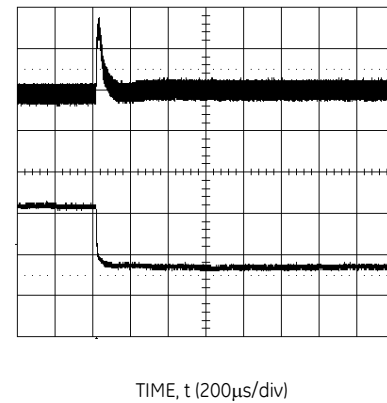

Figure 29. Transient Response to Dynamic Load Change from 50% to 25% of full load current.

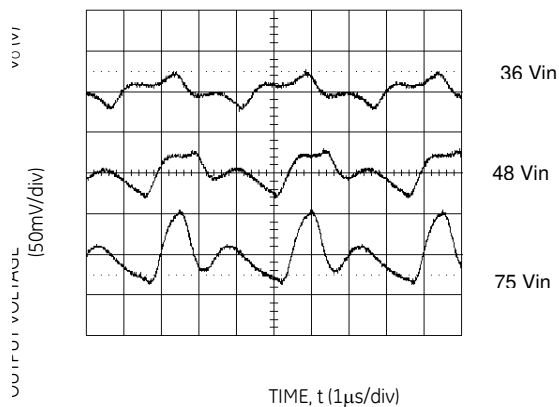

Figure 27. Typical Output Ripple and Noise at Room temperature and $I_o = I_{o,max}$.

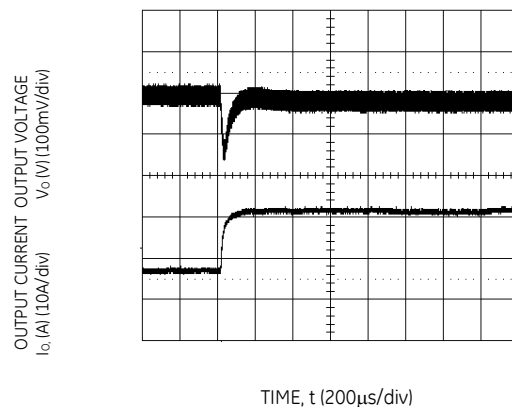

Figure 30. Transient Response to Dynamic Load Change from 25% to 50% of full load current.

JRW017-070 Series Power Modules DC-DC Converters

36-75Vdc Input; 1.2Vdc to 12Vdc Output

Characteristic Curves (continued)

The following figures provide typical characteristics for the JRW070A0M (1.5V, 70A) at 25°C. The figures are identical for either positive or negative Remote On/Off logic.

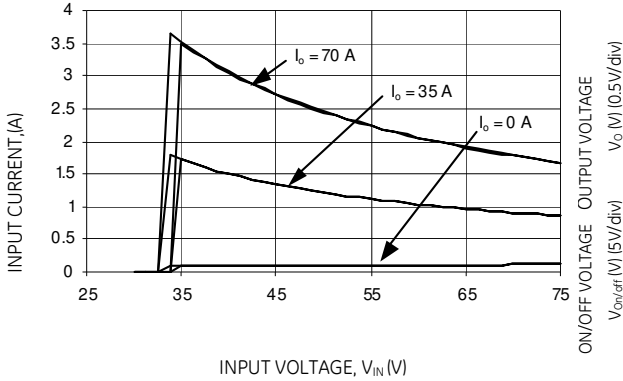

Figure 31. Typical Start-Up (Input Current) characteristics at room temperature.

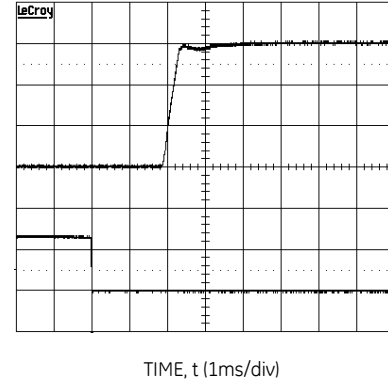

Figure 34. Typical Start-Up Characteristics from Remote ON/OFF.

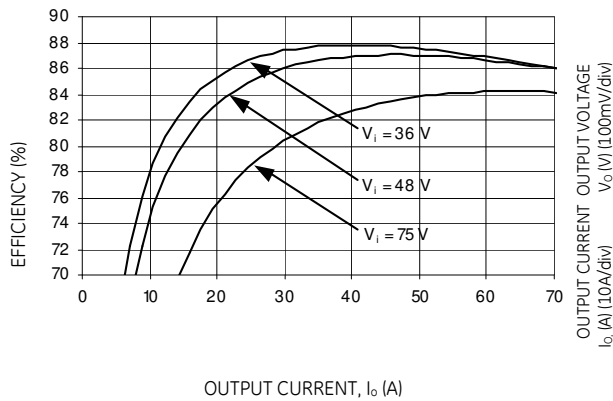

Figure 32. Converter Efficiency Vs Load at Room temperature.

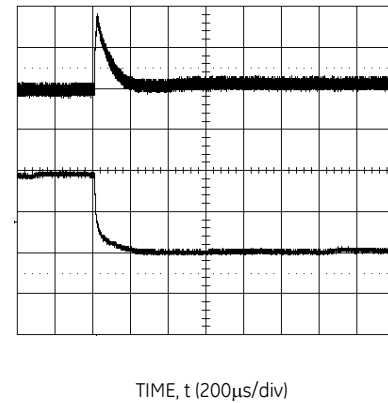

Figure 35. Transient Response to Dynamic Load Change from 50% to 25% of full load current.

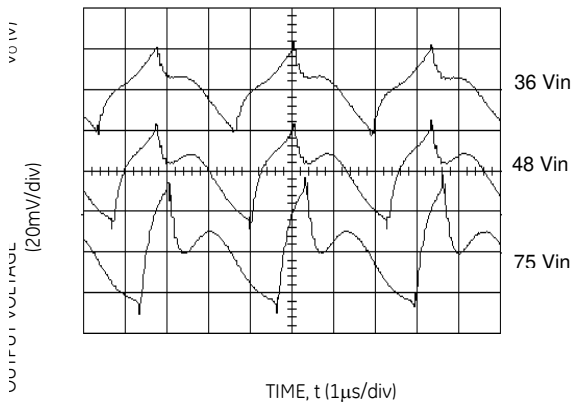

Figure 33. Typical Output Ripple and Noise at Room temperature and $I_o = I_{o,max}$.

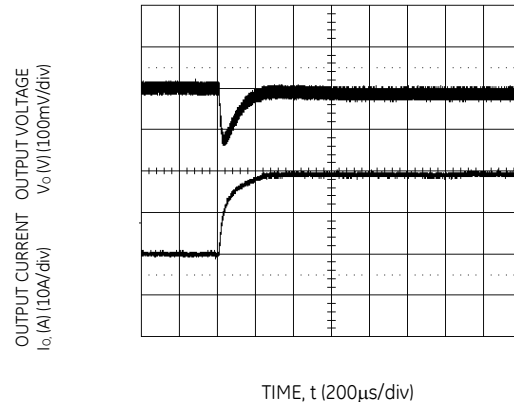

Figure 36. Transient Response to Dynamic Load Change from 25% to 50% of full load current.

JRW017-070 Series Power Modules DC-DC Converters

36-75Vdc Input; 1.2Vdc to 12Vdc Output

Characteristic Curves (continued)

The following figures provide typical characteristics for the JRW070A0P (1.2V, 70A) at 25°C. The figures are identical for either positive or negative Remote On/Off logic.

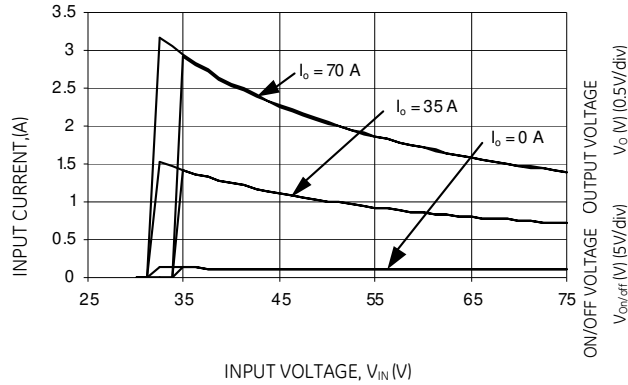

Figure 37. Typical Start-Up (Input Current) characteristics at room temperature.

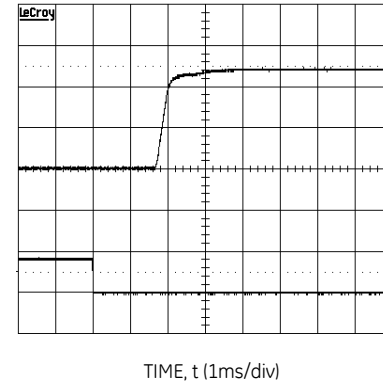

Figure 40. Typical Start-Up Characteristics from Remote ON/OFF.

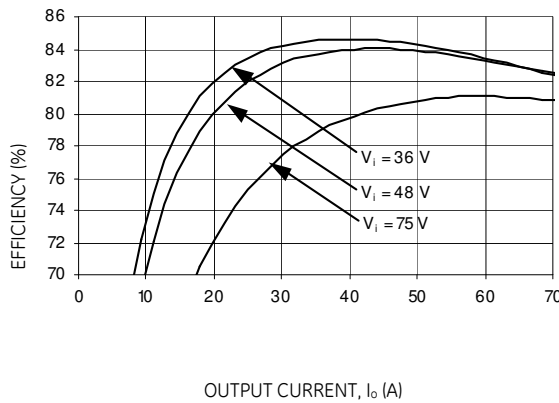

Figure 38. Converter Efficiency Vs Load at Room temperature.

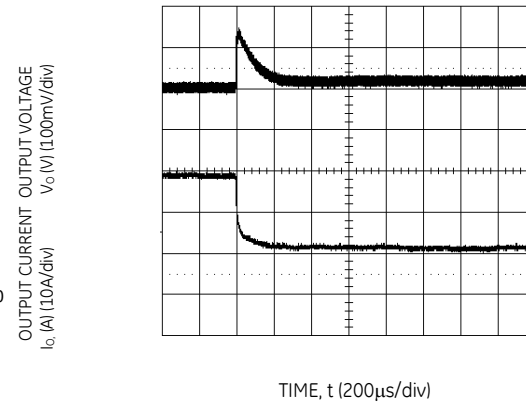

Figure 41. Transient Response to Dynamic Load Change from 50% to 25% of full load current.

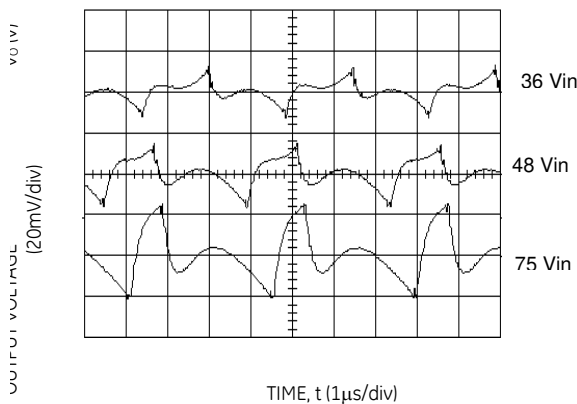

Figure 39. Typical Output Ripple and Noise at Room temperature and $I_o = I_{o,max}$.

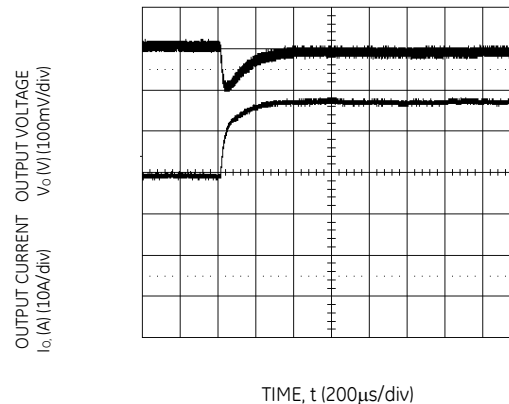
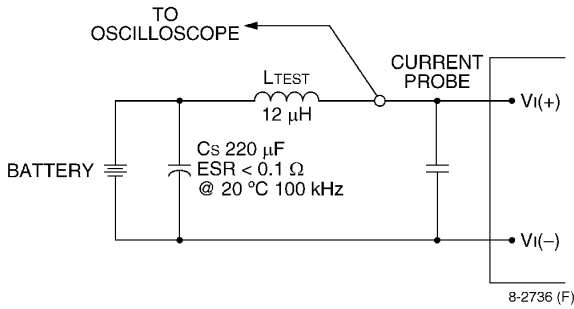

Figure 42. Transient Response to Dynamic Load Change from 50% to 75 % of full load current.

JRW017-070 Series Power Modules DC-DC Converters

36-75Vdc Input; 1.2Vdc to 12Vdc Output

Test Configurations



Note: Measure input reflected-ripple current with a simulated source inductance (LTEST) of 12 μH. Capacitor CS offsets possible battery impedance. Measure current as shown above.

Figure 43. Input Reflected Ripple Current Test Setup.

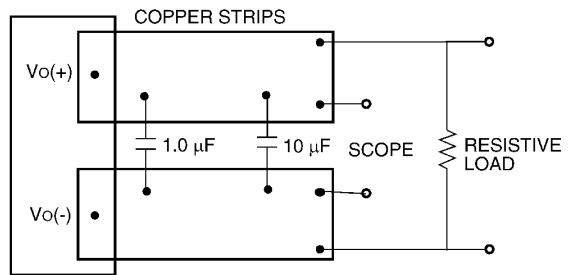

Note: Use a 1.0 μF ceramic capacitor and a 10 μF aluminum or tantalum capacitor. Scope measurement should be made using a BNC socket. Position the load between 51 mm and 76 mm (2 in. and 3 in.) from the module.

Figure 44. Output Ripple and Noise Test Setup.

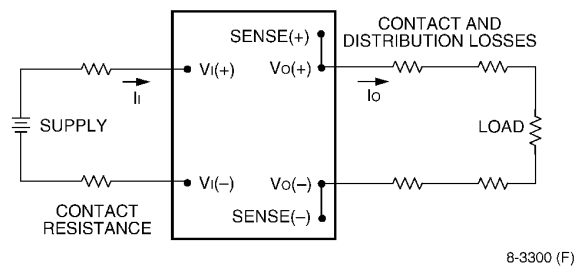

Note: All measurements are taken at the module terminals. When socketing, place Kelvin connections at module terminals to avoid measurement errors due to socket contact resistance.

$$\eta = \left(\frac{[V_O(+)-V_O(-)]I_O}{[V_I(+)-V_I(-)]I_I} \right) \times 100 \%$$

Figure 45. Output Voltage and Efficiency Test Setup.

Design Considerations

Input Source Impedance

The power module should be connected to a low ac-impedance source. A highly inductive source impedance can affect the stability of the power module. For the test configuration in Figure 43, a 100μF electrolytic capacitor (ESR < 0.7Ω at 100kHz), mounted close to the power module helps ensure the stability of the unit. Consult the factory for further application guidelines.

Output Capacitance

High output current transient rate of change (high di/dt) loads may require high values of output capacitance to supply the instantaneous energy requirement to the load. To minimize the output voltage transient drop during this transient, low E.S.R. (equivalent series resistance) capacitors may be required, since a high E.S.R. will produce a correspondingly higher voltage drop during the current transient.

Output capacitance and load impedance interact with the power module's output voltage regulation control system and may produce an 'unstable' output condition for the required values of capacitance and E.S.R. Minimum and maximum values of output capacitance and of the capacitor's associated E.S.R. may be dictated, depending on the module's control system. The process of determining the acceptable values of capacitance and E.S.R. is complex and is load-dependant. GE provides Web-based tools to assist the power module end-user in appraising and adjusting the effect of various load conditions and output capacitances on specific power modules for various load conditions.

Safety Considerations

For safety-agency approval of the system in which the power module is used, the power module must be installed in compliance with the spacing and separation requirements of the end-use safety agency standard, i.e., UL* 60950-1 Recognized, CSA† C22.2 No. 60950-3-01 Certified, and EN 60950-1 (VDE‡ 0805): 2001-12 Licensed.

These converters have been evaluated to the spacing requirements for Basic Insulation per the above safety standards. For Basic Insulation models ("-B" Suffix), 1500 Vdc is applied from Vi to Vo to 100% of outgoing production.

For end products connected to -48V dc, or -60Vdc nominal DC MAINS (i.e. central office dc battery plant), no further fault testing is required.

JRW017-070 Series Power Modules DC-DC Converters 36-75Vdc Input; 1.2Vdc to 12Vdc Output

Safety Considerations (continued)

*Note: -60V dc nominal battery plants are not available in the U.S. or Canada.

For all input voltages, other than DC MAINS, where the input voltage is less than 60V dc, if the input meets all of the requirements for SELV, then:

- The output may be considered SELV. Output voltages will remain within SELV limits even with internally-generated non-SELV voltages. Single component failure and fault tests were performed in the power converters.
- One pole of the input and one pole of the output are to be grounded, or both circuits are to be kept floating, to maintain the output voltage to ground voltage within ELV or SELV limits.

For all input sources, other than DC MAINS, where the input voltage is between 60 and 75V dc (Classified as TNV-2 in Europe), the following must be met, if the converter's output is to be evaluated for SELV:

- The input source is to be provided with reinforced insulation from any hazardous voltage, including the ac mains.
- One Vi pin and one Vo pin are to be reliably earthed, or both the input and output pins are to be kept floating.
- Another SELV reliability test is conducted on the whole system, as required by the safety agencies, on the combination of supply source and the subject module to verify that under a single fault, hazardous voltages do not appear at the module's output.

The power module has ELV (extra-low voltage) outputs when all inputs are ELV.

All flammable materials used in the manufacturing of these modules are rated 94V-0.

The input to these units is to be provided with a maximum 20A fast-acting (or time-delay) fuse in the unearthed lead.

JRW017-070 Series Power Modules DC-DC Converters

36-75Vdc Input; 1.2Vdc to 12Vdc Output

Feature Descriptions

Remote On/Off

Two remote on/off options are available. Positive logic remote on/off turns the module on during a logic-high voltage on the ON/OFF pin, and off during a logic low. Negative logic remote on/off turns the module off during a logic high and on during a logic low. Negative logic, device code suffix "1," is the factory-preferred configuration. To turn the power module on and off, the user must supply a switch to control the voltage between the on/off terminal and the VI (-) terminal (Von/off). The switch can be an open collector or equivalent (see Figure 46). A logic low is Von/off = 0 V to 1.2 V. The maximum Ion/off during a logic low is 1 mA. The switch should maintain a logic-low voltage while sinking 1 mA. During a logic high, the maximum Von/off generated by the power module is 15 V. The maximum allowable leakage current of the switch at Von/off = 15 V is 50 μ A. If not using the remote on/off feature, perform one of the following to turn the unit on:

For negative logic, short ON/OFF pin to VI(-).

For positive logic: leave ON/OFF pin open.

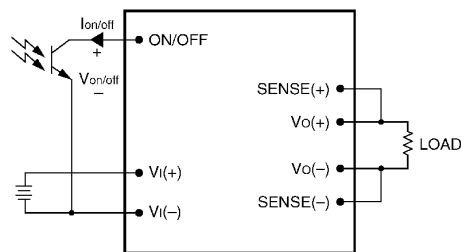

8-720c

Figure 46. Remote On/Off Implementation.

Overcurrent Protection

To provide protection in a fault output overload condition, the module is equipped with internal current-limiting circuitry and can endure current limit for few seconds. If overcurrent persists for few seconds, the module will shut down and remain latch-off. The overcurrent latch is reset by either cycling the input power or by toggling the on/off pin for one second. If the output overload condition still exists when the module restarts, it will shut down again. This operation will continue indefinitely until the overcurrent condition is corrected.

An auto-restart option is also available.

Input Undervoltage Lockout

At input voltages below the input undervoltage lockout limit, the module operation is disabled. The module will begin to operate at an input voltage above the undervoltage lockout turn-on threshold.

Overtemperature Protection

These modules feature an overtemperature protection circuit to safeguard against thermal damage. The circuit shuts down and latches off the module when the maximum device reference temperature is exceeded. The module can be restarted by cycling the dc input power for at least one second or by toggling the remote on/off signal for at least one second.

Over Voltage Protection

The output overvoltage protection consists of circuitry that monitors the voltage on the output terminals. If the voltage on the output terminals exceeds the overvoltage protection threshold, then the module will shutdown and latch off. The overvoltage latch is reset by either cycling the input power for one second or by toggling the on/off signal for one second. The protection mechanism is such that the unit can continue in this condition until the fault is cleared.

Remote sense

Remote sense minimizes the effects of distribution losses by regulating the voltage at the remote-sense connections. The voltage between the remote-sense pins and the output terminals must not exceed the output voltage sense range given in the Feature Specifications table i.e.:

$$[Vo(+) - Vo(-)] - [SENSE(+) - SENSE(-)] \leq 10\% \text{ of } V_{o,nom.}$$

The voltage between the Vo(+) and Vo(-) terminals must not exceed the minimum output overvoltage shut-down value indicated in the Feature Specifications table. This limit includes any increase in voltage due to remote-sense compensation and output voltage set-point adjustment (trim). See Figure 47. If not using the remote-sense feature to regulate the output at the point of load, then connect SENSE(+) to Vo(+) and SENSE(-) to Vo(-) at the module.

Although the output voltage can be increased by both the remote sense and by the trim, the maximum increase for the output voltage is not the sum of both. The maximum increase is the larger of either the remote sense or the trim. The amount of power delivered by the module is defined as the voltage at the output terminals multiplied by the output current. When using remote sense and trim: the output voltage of the module can be increased, which at the same output current would increase the power output of the module. Care should be taken to ensure that the maximum output power of the module remains at or below the maximum rated power.

JRW017-070 Series Power Modules DC-DC Converters

36-75Vdc Input; 1.2Vdc to 12Vdc Output

Feature Descriptions (continued)

Remote sense (continued)

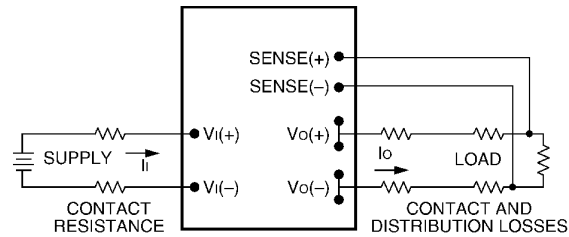

Figure 47. Effective Circuit Configuration for Single-Module Remote-Sense Operation Output Voltage.

Output Voltage Programming

Trimming allows the user to increase or decrease the output voltage set point of a module. This is accomplished by connecting an external resistor between the TRIM pin and either the SENSE(+) or SENSE(-) pins. The trim resistor should be positioned close to the module.

If not using the trim feature, leave the TRIM pin open.

With an external resistor between the TRIM and SENSE(-) pins ($R_{adj-down}$), the output voltage set point ($V_{o,adj}$) decreases (see Figure 36). The following equation determines the required external-resistor value to obtain a percentage output voltage change of $\Delta\%$.

For output voltages: 1.2V – 12V

$$R_{adj-down} = \left(\frac{100}{\Delta\%} - 2 \right) K\Omega$$

Where,

$$\Delta\% = \left| \frac{V_{o,nom} - V_{desired}}{V_{o,nom}} \right| \times 100$$

$V_{desired}$ = Desired output voltage set point (V).

With an external resistor connected between the TRIM and SENSE(+) pins (R_{adj-up}), the output voltage set point ($V_{o,adj}$) increases (see Figure 37).

The following equation determines the required external-resistor value to obtain a percentage output voltage change of $\Delta\%$.

For output voltages: 1.5V – 12V

$$R_{adj-up} = \left(\frac{V_{o,nom} * (100 + \Delta\%)}{1.225 * \Delta\%} - \frac{(100 + 2 * \Delta\%)}{\Delta\%} \right) K\Omega$$

For output voltage: 1.2V

$$R_{adj-up} = \left(\frac{V_{o,nom} * (100 + \Delta\%)}{0.6 * \Delta\%} - \frac{(100 + 2 * \Delta\%)}{\Delta\%} \right) K\Omega$$

Where,

$$\Delta\% = \left| \frac{V_{o,nom} - V_{desired}}{V_{o,nom}} \right| \times 100$$

$V_{desired}$ = Desired output voltage set point (V).

The voltage between the $V_{o}(+)$ and $V_{o}(-)$ terminals must not exceed the minimum output overvoltage shut-down value indicated in the Feature Specifications table. This limit includes any increase in voltage due to remote-sense compensation and output voltage set-point adjustment (trim). See Figure 48.

Although the output voltage can be increased by both the remote sense and by the trim, the maximum increase for the output voltage is not the sum of both. The maximum increase is the larger of either the remote sense or the trim.

The amount of power delivered by the module is defined as the voltage at the output terminals multiplied by the output current. When using remote sense and trim, the output voltage of the module can be increased, which at the same output current would increase the power output of the module. Care should be taken to ensure that the maximum output power of the module remains at or below the maximum rated power.

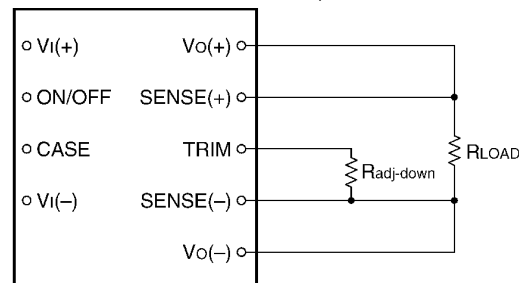

Figure 48. Circuit Configuration to Decrease Output Voltage.

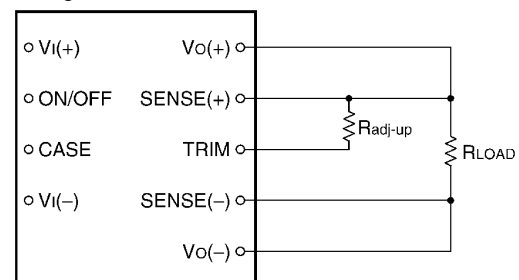

Figure 49. Circuit Configuration to Increase Output Voltage.

JRW017-070 Series Power Modules DC-DC Converters 36-75Vdc Input; 1.2Vdc to 12Vdc Output

Feature Descriptions (continued)

Output Voltage Programming (continued)

Examples:

To trim down the output of a nominal 3.3V module (JRW060A0F) to 3.1V

$$\Delta\% = \left| \frac{3.3V - 3.1V}{3.3V} \right| \times 100$$

$$\Delta\% = 6.06$$

$$R_{adj-down} = \left(\frac{100}{6.06} - 2 \right) K\Omega$$

$$R_{adj-down} = 14.5 \text{ k}\Omega$$

To trim up the output of a nominal 3.3V module (JRW060A0F) to 3.6V

$$\Delta\% = \left| \frac{3.6V - 3.3V}{3.3V} \right| \times 100$$

$$\Delta\% = 9.1$$

$$R_{adj-up} = \left(\frac{3.3 * (100 + 9.1)}{1.225 * 9.1} - \frac{(100 + 2 * 9.1)}{9.1} \right) K\Omega$$

$$R_{adj-up} = 19.3 \text{ k}\Omega$$

JRW017-070 Series Power Modules DC-DC Converters 36-75Vdc Input; 1.2Vdc to 12Vdc Output

Thermal Considerations

The power modules operate in a variety of thermal environments; however, sufficient cooling should be provided to help ensure reliable operation.

Considerations include ambient temperature, airflow, module power dissipation, and the need for increased reliability. A reduction in the operating temperature of the module will result in an increase in reliability. The thermal data presented here is based on physical measurements taken in a wind tunnel.

Heat-dissipating components are mounted on the topside of the module. Heat is removed by conduction, convection and radiation to the surrounding environment. Proper cooling can be verified by measuring the thermal reference temperature (T_{ref}). The peak temperature (T_{ref}) occurs at the position indicated in Figures 50 - 52. The temperature at any one of these locations should not exceed per below table to ensure reliable operation of the power module.

Model	Device	Temperature (°C)
JRW070AOP (1.2V)	T_{ref3}	117
JRW070AOM (1.5V)	T_{ref2}/ T_{ref3}	115/118
JRW065AOY (1.8V)	T_{ref3}	115
JRW065AOG (2.5V)	T_{ref2}/ T_{ref3}	117/118
JRW060AOF (3.3V)	T_{ref1}/ T_{ref2}	117/118
JRW040A0A (5V)	T_{ref1}	117
JRW017A0B (12V)	T_{ref1}	117

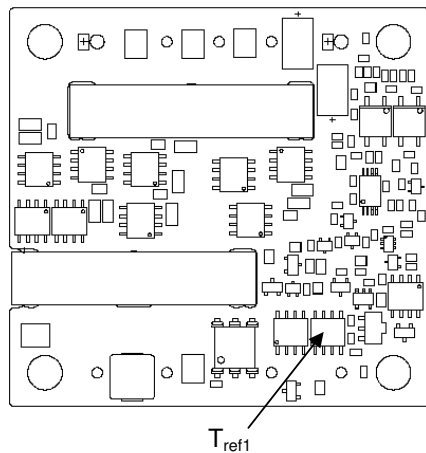

Figure 50. T_{ref} Temperature Measurement Location for $V_o=12V$.

Please refer to the Application Note “Thermal Characterization Process For Open-Frame Board-Mounted Power Modules” for a detailed discussion of thermal aspects including maximum device temperatures.

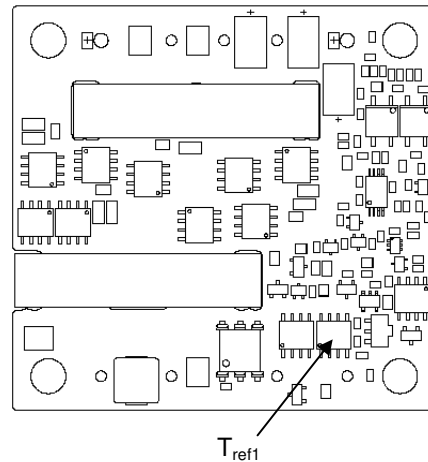

Figure 51. T_{ref} Temperature Measurement Location for $V_o=5V$.

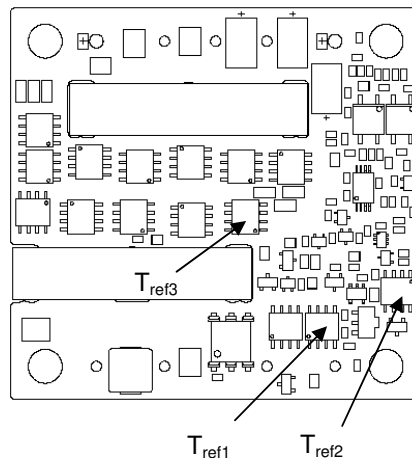

Figure 52. T_{ref} Temperature Measurement Locations for $V_o=3.3V - 1.2V$.

The output power of the module should not exceed the rated power for the module as listed in the Ordering Information table.

Although the maximum T_{ref} temperature of the power modules is approximately 117 °C, you can limit this temperature to a lower value for extremely high reliability.

Heat Transfer via Convection

Increased airflow over the module enhances the heat transfer via convection. Following derating figures shows the maximum output current that can be delivered by each module in the respective orientation without exceeding the maximum T_{ref} temperature versus local ambient temperature (T_a) for natural convection through 2m/s (400 ft./min).

JRW017-070 Series Power Modules DC-DC Converters

36-75Vdc Input; 1.2Vdc to 12Vdc Output

Note that the natural convection condition was measured at 0.05 m/s to 0.1 m/s (10ft./min. to 20 ft./min.); however, systems in which these power modules may be used typically generate natural convection airflow rates of 0.3 m/s (60 ft./min.) due to other heat dissipating components in the system. The use of Figures 53 - 59 are shown in the following example:

Example

What is the minimum airflow necessary for a JRW060A0F operating at $V_I = 48V$, an output current of 42A, and a maximum ambient temperature of 70 °C in transverse orientation.

Solution:

Given: $V_I = 48V$

$I_o = 48A$

$T_A = 70\text{ }^\circ\text{C}$

Determine airflow (V) (Use Figure 53):

$V = 1\text{m/sec. (200ft./min.)}$

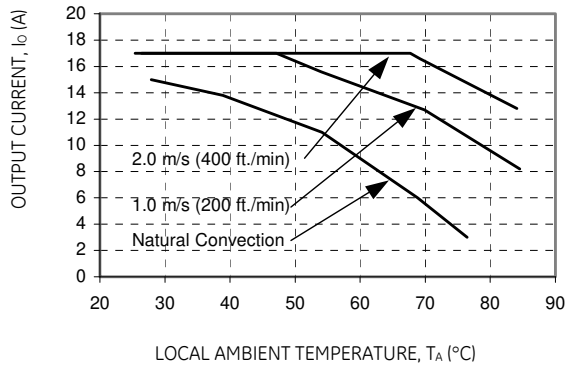

Figure 53. Output Power Derating for JRW017A0B ($V_o = 12V$) in Transverse Orientation with no baseplate; Airflow Direction From $V_{in}(+)$ to $V_{in}(-)$; $V_{in} = 48V$.

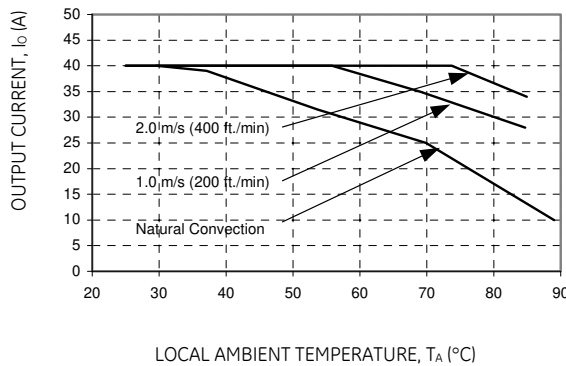

Figure 54. Output Power Derating for JRW040A0A ($V_o = 5V$) in Transverse Orientation with no baseplate; Airflow Direction From $V_{in}(+)$ to $V_{in}(-)$; $V_{in} = 48V$.

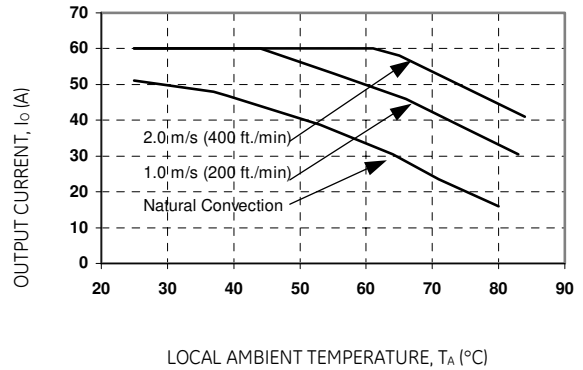

Figure 55. Output Power Derating for JRW060A0F ($V_o = 3.3V$) in Transverse Orientation with no baseplate; Airflow Direction From $V_{in}(+)$ to $V_{in}(-)$; $V_{in} = 48V$.

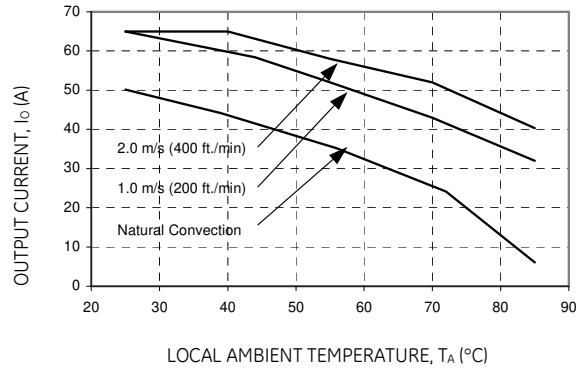

Figure 56. Output Power Derating for JRW065A0G ($V_o = 2.5V$) in Transverse Orientation with no baseplate; Airflow Direction From $V_{in}(+)$ to $V_{in}(-)$; $V_{in} = 48V$.

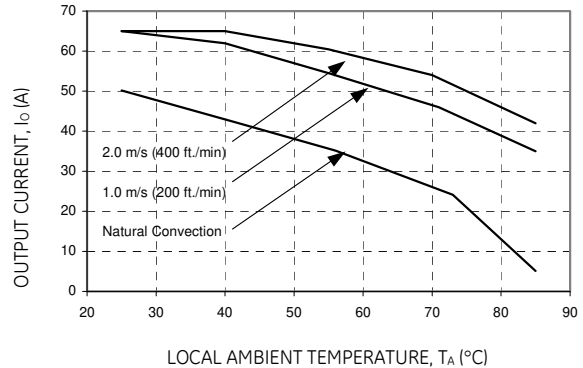

Figure 57. Output Power Derating for JRW065A0Y ($V_o = 1.8V$) in Transverse Orientation with no baseplate; Airflow Direction From $V_{in}(+)$ to $V_{in}(-)$; $V_{in} = 48V$.

JRW017-070 Series Power Modules DC-DC Converters
 36-75Vdc Input; 1.2Vdc to 12Vdc Output

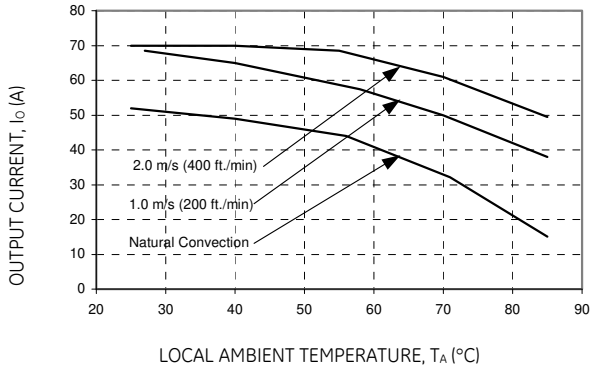

Figure 58. Output Power Derating for JRW070A0M (Vo = 1.5V) in Transverse Orientation with no baseplate; Airflow Direction From Vin(+) to Vin(-); Vin = 48V.

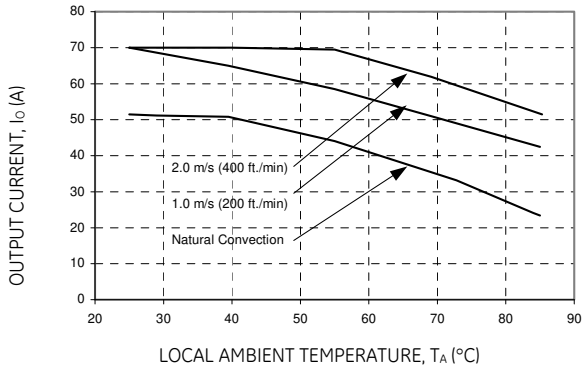

Figure 59. Output Power Derating for JRW070A0P (Vo = 1.2V) in Transverse Orientation with no baseplate; Airflow Direction From Vin(+) to Vin(-); Vin = 48V.

JRW017-070 Series Power Modules DC-DC Converters 36-75Vdc Input; 1.2Vdc to 12Vdc Output

Layout Considerations

The JRW power module series are low profile in order to be used in fine pitch system and architectures. As such, component clearances between the bottom of the power module and the mounting board are limited. Either avoid placing copper areas on the outer layer directly underneath the power module or maintain a minimum clearance through air of 0.028 inches between any two "opposite polarity" components, including copper traces under the module to components on the JRW module..

compliant through-hole products can be processed with paste-through-hole Pb or Pb-free reflow process. If additional information is needed, please consult with your GE representative for more details.

For modules with a "7" (case (heatplate) pin) and "-H" (heatplate) option:

To meet Basic Insulation in the end product 1) between the input and output of the module, or 2) between the input and the earth ground, a series capacitor (capable of withstanding 1500V dc) needs to be inserted between the case pin and the end termination point, if the case pin is connected to the input or the output of the JRW module or to earth ground.

For additional layout guide-lines, refer to FLTR100V10 data sheet.

Post Solder Cleaning and Drying Considerations

Post solder cleaning is usually the final circuit-board assembly process prior to electrical board testing. The result of inadequate cleaning and drying can affect both the reliability of a power module and the testability of the finished circuit-board assembly. For guidance on appropriate soldering, cleaning and drying procedures, refer to *GE Board Mounted Power Modules: Soldering and Cleaning* Application Note (AP01-056EPS).

Through-Hole Lead-Free Soldering Information

The RoHS-compliant through-hole products use the SAC (Sn/Ag/Cu) Pb-free solder and RoHS-compliant components. They are designed to be processed through single or dual wave soldering machines. The pins have an RoHS-compliant finish that is compatible with both Pb and Pb-free wave soldering processes. A maximum preheat rate of 3°C/s is suggested. The wave preheat process should be such that the temperature of the power module board is kept below 210°C. For Pb solder, the recommended pot temperature is 260°C, while the Pb-free solder pot is 270°C max. Not all RoHS-

Mechanical Outline

Dimensions are in millimeters and (inches).

JRW017-070 Series Power Modules DC-DC Converters

36-75Vdc Input; 1.2Vdc to 12Vdc Output

Tolerances: x.x mm ± 0.5 mm (x.xx in. ± 0.02 in.) [unless otherwise indicated]
 x.xx mm ± 0.25 mm (x.xxx in ± 0.010 in.)

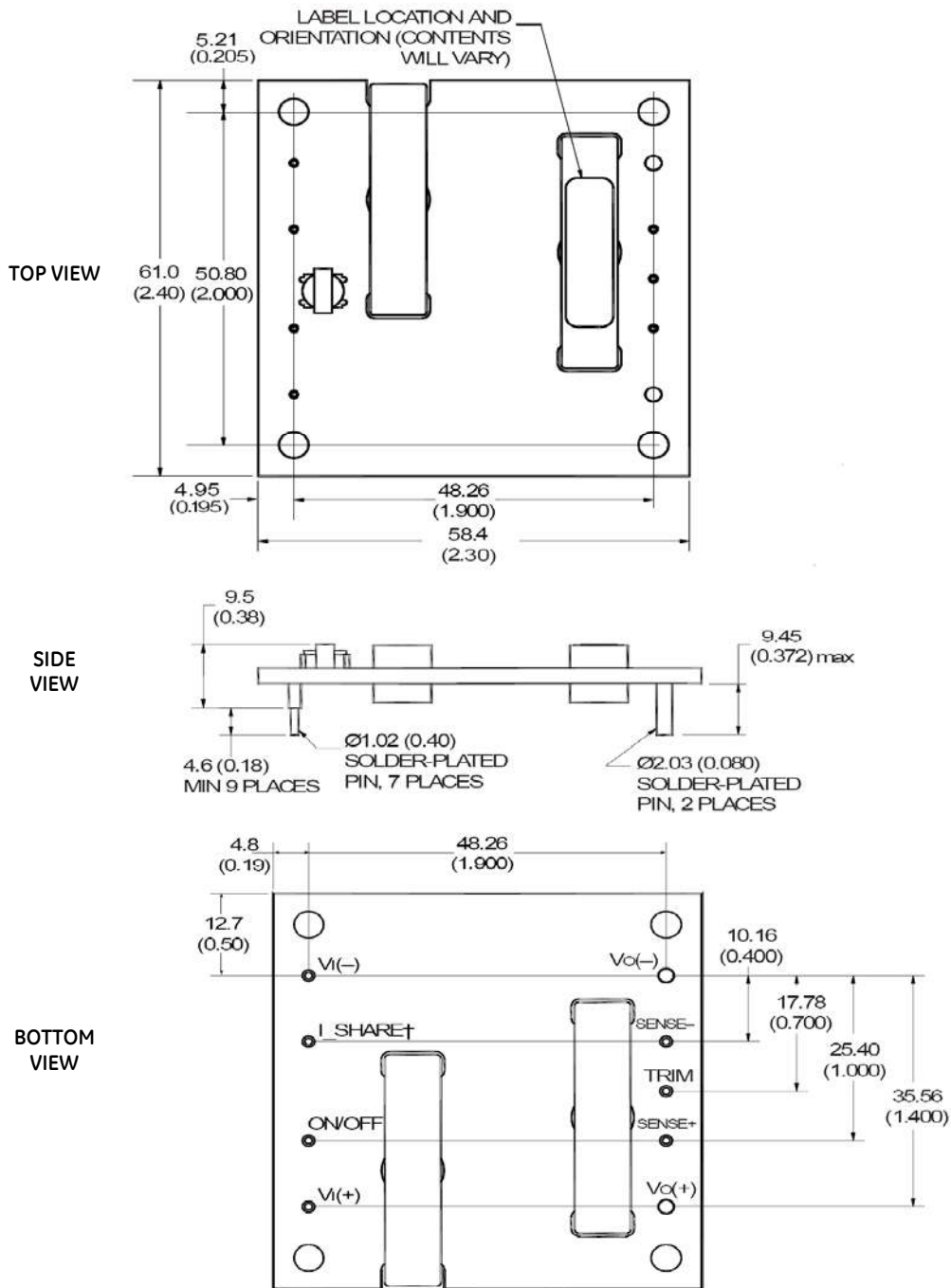

Topside label includes GE name, product designation, and data code.

†Option Feature, Pin is not present unless one these options specified. The I_share and case pin option cannot be specified simultaneously.

JRW017-070 Series Power Modules DC-DC Converters

36-75Vdc Input; 1.2Vdc to 12Vdc Output

Recommended Pad Layout

Dimensions are in millimeters and (inches).

Tolerances: x.x mm ± 0.5 mm (x.xx in. ± 0.02 in.) [unless otherwise indicated]

x.xx mm ± 0.25 mm (x.xxx in ± 0.010 in.)

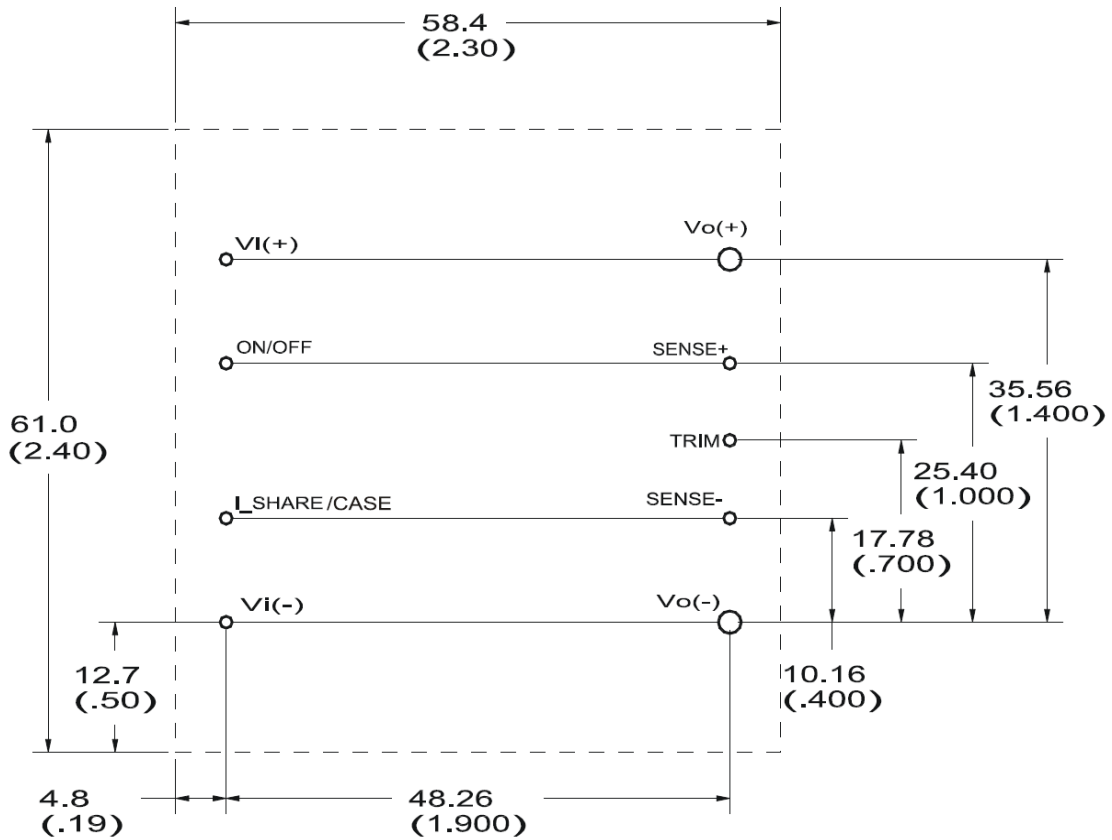

JRW017-070 Series Power Modules DC-DC Converters

36-75Vdc Input; 1.2Vdc to 12Vdc Output

Ordering Information

Table 3. Device Code

Product codes	Input Voltage	Output Voltage	Output Current	Efficiency	Connector Type	Comcodes
JRW017A0B1	48V (36-75Vdc)	12V	17A	92%	Through hole	108967142
JRW040A0A1	48V (36-75Vdc)	5V	40A	92%	Through hole	108965385
JRW060A0F1	48V (36-75Vdc)	3.3V	60A	91%	Through hole	108965393
JRW065A0G1	48V (36-75Vdc)	2.5V	65A	90%	Through hole	108965401
JRW065A0Y1	48V (36-75Vdc)	1.8V	65A	87%	Through hole	108965435
JRW070A0M1	48V (36-75Vdc)	1.5V	70A	86%	Through hole	108965419
JRW070A0P1	48V (36-75Vdc)	1.2V	70A	84%	Through hole	108965427
JRW017A0B1Z	48V (36-75Vdc)	12V	17A	92%	Through hole	CC109104618
JRW040A0A1Z	48V (36-75Vdc)	5V	40A	92%	Through hole	CC109107422
JRW040A0A61-HZ	48V (36-75Vdc)	5V	40A	92%	Through hole	CC109101978
JRW060A0F1-HZ	48V (36-75Vdc)	3.3V	60A	91%	Through hole	CC109107455
JRW065A0G1-HZ	48V (36-75Vdc)	2.5V	65A	90%	Through hole	CC109107471

Table 2. Device Options

Option	Device Code Suffix
Negative remote on/off logic	1
Auto-restart	4
Pin Length: 3.68 mm ± 0.25mm (0.145 in. ± 0.010 in.)	6
Case pin (Available with Baseplate option only)*	7
Base Plate option	-H
Output current share (Parallel Operation)*	-P
RoHS Compliant	-Z

*Note: The case pin and Ishare pin use the same pin location such that both options cannot be specified simultaneously.

Contact Us

For more information, call us at

USA/Canada:

+1 877 546 3243, or +1 972 244 9288

Asia-Pacific:

+86.021.54279977*808

Europe, Middle-East and Africa:

+49.89.878067-280



www.gecriticalpower.com

GE Critical Power reserves the right to make changes to the product(s) or information contained herein without notice, and no liability is assumed as a result of their use or application. No rights under any patent accompany the sale of any such product(s) or information.