

MBR2045CTU SCHOTTKY RECTIFIER

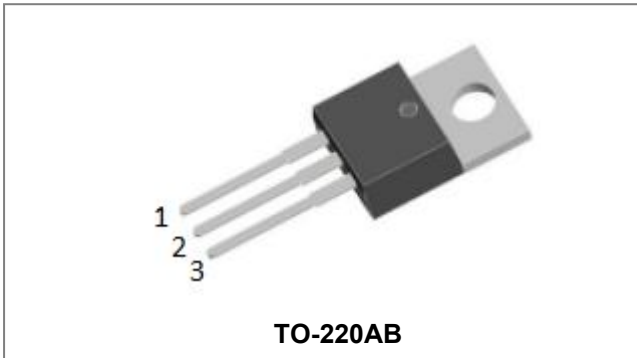

Features

- 150°C T_J operation
- Center tap configuration
- Low forward voltage drop
- High purity, high temperature epoxy encapsulation for enhanced
- mechanical strength and moisture resistance
- High frequency operation
- Guard ring for enhanced ruggedness and long term reliability
- This is a Pb – Free Device
- All SMC parts are traceable to the wafer lot
- Additional testing can be offered upon request

Circuit Diagram

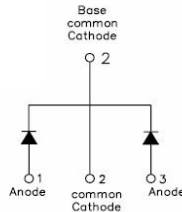

Applications

- Switching power supply
- Converters
- Free-Wheeling diodes
- Reverse battery protection

Maximum Ratings:

Characteristics	Symbol	Condition	Max.	Units
Peak Repetitive Reverse Voltage	V _{RRM}	-	45	V
Working Peak Reverse Voltage	V _{RWM}			
DC Blocking Voltage	V _R			
Average Rectified Forward Current	I _{F(AV)}	50% duty cycle @T _c =115°C, rectangular wave form	10(Per Leg) 20(Per Device)	A
Peak One Cycle Non-Repetitive Surge Current(Per Leg)	I _{FSM}	8.3ms, Half Sine pulse, T _c = 25 °C	220	A

Electrical Characteristics:

Characteristics	Symbol	Condition	Typ.	Max.	Units
Forward Voltage Drop(Per Leg)*	V _{F1}	@ 20A, Pulse, T _J = 25 °C	0.75	0.81	V
	V _{F2}	@ 20A, Pulse, T _J = 125 °C	0.70	0.75	V
Reverse Current(Per Leg)*	I _{R1}	@V _R = rated V _R , T _J = 25 °C	0.03	1.0	mA
	I _{R2}	@V _R = rated V _R , T _J = 125 °C	9	15.0	mA
Junction Capacitance(Per Leg)	C _T	@V _R = 5V, T _c = 25 °C f _{SIG} = 1MHz	260	600	pF
Series Inductance(Per Leg)	L _S	Measured lead to lead 5 mm from package body	8.0	-	nH
Voltage Rate of Change	dv/dt	-	-	10,000	V/μs

* Pulse width < 300 μs, duty cycle < 2%

Thermal-Mechanical Specifications:

Characteristics	Symbol	Condition	Specification	Units
Junction Temperature	T_J	-	-55 to +150	°C
Storage Temperature	T_{stg}	-	-55 to +150	°C
Typical Thermal Resistance Junction to Case(Per Leg)	$R_{\theta JC}$	DC operation	2.0	°C/W
Approximate Weight	wt	-	2	g

Ratings and Characteristics Curves

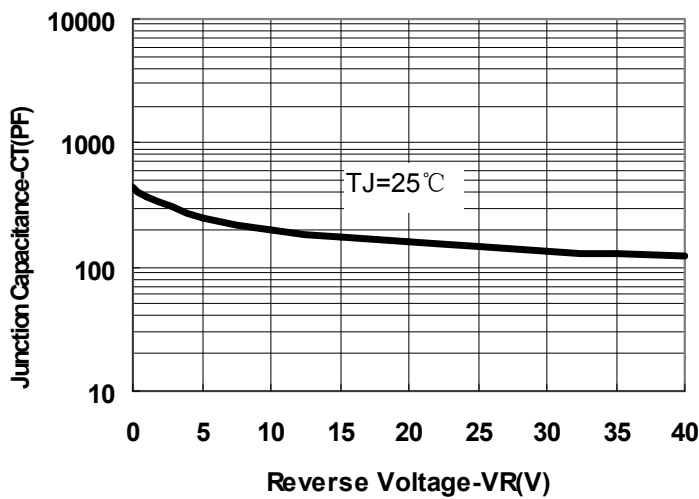

Fig.1-Typical Junction Capacitance

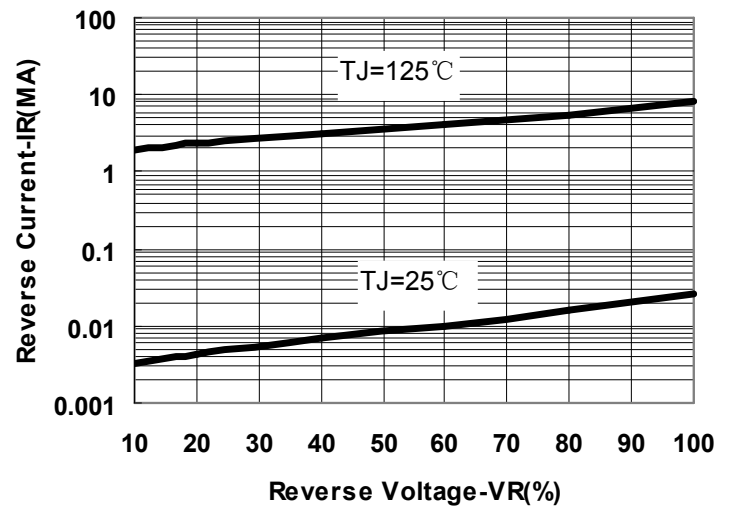

Fig.2-Typical Reverse Characteristics

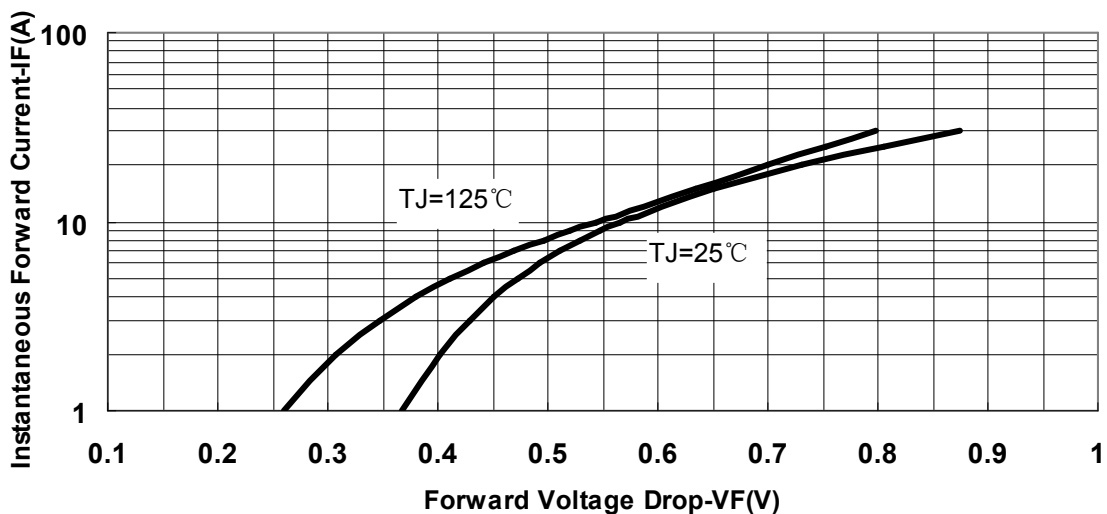

Fig.3-Typical Instantaneous Forward Voltage Characteristics

Mechanical Dimensions TO-220AB



Symbol	Dimensions in millimeters		
	Min	Typical	Max
A	4.42	4.57	4.72
A1	1.17	1.27	1.37
A2	2.52	2.69	2.89
b	0.71	0.81	0.96
b1	1.17	1.27	1.37
c	0.31	0.38	0.61
D	14.94	15.24	15.54
D1	8.85	9.00	9.15
E	10.01	10.16	10.31
e		2.54	
e1	4.98	5.06	5.18
H1	6.04	6.24	6.44
L	12.7	13.56	13.80
L1	3.56	3.5	3.96
ΦP	3.74	3.84	4.04
Q	2.54	2.74	2.94
θ1		7°	
θ2		3°	
θ3		4°	

Tube Specification

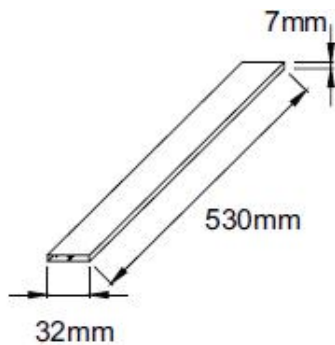

Marking Diagram

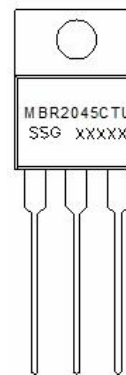

Where XXXXX is YYWWL

- MBR = Device Type
- 20 = Forward Current (20A)
- 45 = Reverse Voltage(45V)
- CTU = Configuration
- SSG = SSG
- YY = Year
- WW = Week
- L = Lot Number

Cautions: Molding resin
Epoxy resin UL:94V-0

Ordering Information

Device	Package	Shipping
MBR2045CTU	TO-220AB (Pb-Free)	50 pcs/ tube

For information on tape and reel specifications, including part orientation and tape sizes, please refer to our tape and reel packaging specification.

DISCLAIMER:

1- The information given herein, including the specifications and dimensions, is subject to change without prior notice to improve product characteristics. Before ordering, purchasers are advised to contact the SMC - Sangdest Microelectronics (Nanjing) Co., Ltd sales department for the latest version of the datasheet(s).

2- In cases where extremely high reliability is required (such as use in nuclear power control, aerospace and aviation, traffic equipment, medical equipment, and safety equipment), safety should be ensured by using semiconductor devices that feature assured safety or by means of users' fail-safe precautions or other arrangement.

3- In no event shall SMC - Sangdest Microelectronics (Nanjing) Co., Ltd be liable for any damages that may result from an accident or any other cause during operation of the user's units according to the datasheet(s). SMC - Sangdest Microelectronics (Nanjing) Co., Ltd assumes no responsibility for any intellectual property claims or any other problems that may result from applications of information, products or circuits described in the datasheets.

4- In no event shall SMC - Sangdest Microelectronics (Nanjing) Co., Ltd be liable for any failure in a semiconductor device or any secondary damage resulting from use at a value exceeding the absolute maximum rating.

5- No license is granted by the datasheet(s) under any patents or other rights of any third party or SMC - Sangdest Microelectronics (Nanjing) Co., Ltd.

6- The datasheet(s) may not be reproduced or duplicated, in any form, in whole or part, without the expressed written permission of SMC - Sangdest Microelectronics (Nanjing) Co., Ltd.

7- The products (technologies) described in the datasheet(s) are not to be provided to any party whose purpose in their application will hinder maintenance of international peace and safety nor are they to be applied to that purpose by their direct purchasers or any third party. When exporting these products (technologies), the necessary procedures are to be taken in accordance with related laws and regulations..