



# 74VHC14

## Hex Schmitt Inverter

### General Description

The VHC14 is an advanced high speed CMOS Hex Schmitt Inverter fabricated with silicon gate CMOS technology. It achieves the high speed operation similar to equivalent Bipolar Schottky TTL while maintaining the CMOS low power dissipation. Pin configuration and function are the same as the VHC04 but the inputs have hysteresis between the positive-going and negative-going input thresholds, which are capable of transforming slowly changing input signals into sharply defined, jitter-free output signals, thus providing greater noise margin than conventional inverters.

An input protection circuit ensures that 0V to 7V can be applied to the input pins without regard to the supply voltage. This device can be used to interface 5V to 3V systems and two supply systems such as battery back up. This circuit prevents device destruction due to mismatched supply and input voltages.

### Features

- High Speed:  $t_{PD} = 5.5 \text{ ns (typ)}$  at  $V_{CC} = 5V$
- Low power dissipation:  $I_{CC} = 2 \mu\text{A (Max)}$  at  $T_A = 25^\circ\text{C}$
- High noise immunity:  $V_{NIH} = V_{NIL} = 28\% V_{CC} \text{ (Min)}$
- Power down protection is provided on all inputs
- Low noise:  $V_{OLP} = 0.8V \text{ (Max)}$
- Pin and function compatible with 74HC14

### Ordering Code:

Order Number	Package Number	Package Description
74VHC14M (Note 1)	M14A	14-Lead Small Outline Integrated Circuit (SOIC), JEDEC MS-012, 0.150" Narrow
74VHC14MX_NL (Note 2)	M14A	Pb-Free 14-Lead Small Outline Integrated Circuit (SOIC), JEDEC MS-012, 0.150" Narrow
74VHC14SJ (Note 1)	M14D	Pb-Free 14-Lead Small Outline Package (SOP), EIAJ TYPE II, 5.3mm Wide
74VHC14MTC (Note 1)	MTC14	14-Lead Thin Shrink Small Outline Package (TSSOP), JEDEC MO-153, 4.4mm Wide
74VHC14MTC_NL (Note 3)	MTC14	Pb-Free 14-Lead Thin Shrink Small Outline Package (TSSOP), JEDEC MO-153, 4.4mm Wide
74VHC14MTCX_NL (Note 2)	MTC14	Pb-Free 14-Lead Thin Shrink Small Outline Package (TSSOP), JEDEC MO-153, 4.4mm Wide
74VHC14N (Obsolete)	N14A	14-Lead Plastic Dual-In-Line Package (PDIP), JEDEC MS-001, 0.300" Wide

Pb-Free package per JEDEC J-STD-020B.

**Note 1:** Surface mount packages are also available on Tape and Reel. Specify by appending the suffix letter "X" to the ordering code.

**Note 2:** "\_NL" indicates Pb-Free product (per JEDEC J-STD-020B). Device is available in Tape and Reel only.

**Note 3:** "\_NL" indicates Pb-Free product (per JEDEC J-STD-020B).

## Logic Symbol/s

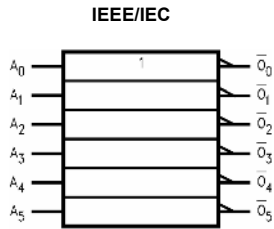

## Connection Diagram/s

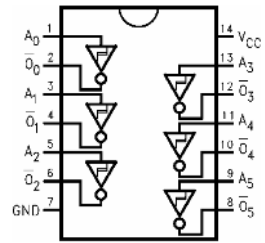

## Pin Descriptions

Pin Names	Description
$A_n$	Inputs
$\overline{O}_n$	Outputs

## Truth Table/s

A	O
L	H
H	L

## Absolute Maximum Ratings (Note 4)

Supply Voltage ( $V_{CC}$ )	-0.5V to +7.0V
DC Input Voltage ( $V_{IN}$ )	-0.5V to +7.0V
DC Output Voltage ( $V_{OUT}$ )	-0.5V to $V_{CC} + 0.5V$
Input Diode Current ( $I_{IK}$ )	-20 mA
Output Diode Current ( $I_{OK}$ )	±20 mA
DC Output Current ( $I_{OUT}$ )	±25 mA
DC $V_{CC}/GND$ Current ( $I_{CC}$ )	±50 mA
Storage Temperature ( $T_{STG}$ )	-65°C to +150°C
Lead Temperature ( $T_L$ )	
Soldering (10 seconds)	260°C

## Recommended Operating Conditions (Note 5)

Supply Voltage ( $V_{CC}$ )	+2.0V to +5.5V
Input Voltage ( $V_{IN}$ )	0V to +5.5V
Output Voltage ( $V_{OUT}$ )	0V to $V_{CC}$
Operating Temperature ( $T_{OPR}$ )	-40°C to +85°C

**Note 4:** Absolute maximum ratings are values beyond which the device may be damaged or have its useful life impaired. The data book specifications should be met, without exception, to ensure that the system design is reliable over its power supply, temperature, and output/input loading variables. Fairchild does not recommend operation outside databook specifications.

**Note 5:** Unused inputs must be held HIGH or LOW. They may not float.

## DC Electrical Characteristics

Symbol	Parameter	$V_{CC}$	$T_A = 25^\circ\text{C}$			$T_A = -40^\circ\text{C to } +85^\circ\text{C}$		Units	Conditions
			Min	Typ	Max	Min	Max		
$V_P$	Positive Threshold Voltage	3.0			2.20		2.20	V	
		4.5			3.15		3.15		
		5.5			3.85		3.85		
$V_N$	Negative Threshold Voltage	3.0	0.90			0.90		V	
		4.5	1.35			1.35			
		5.5	1.65			1.65			
$V_H$	Hysteresis Voltage	3.0	0.30		1.20	0.30	1.20	V	
		4.5	0.40		1.40	0.40	1.40		
		5.5	0.50		1.60	0.50	1.60		
$V_{OH}$	HIGH Level Output Voltage	2.0	1.9	2.0		1.9		V	$V_{IN} = V_{IL}$ $I_{OH} = -50 \mu\text{A}$
		3.0	2.9	3.0		2.9			
		4.5	4.4	4.5		4.4		V	$I_{OH} = -4 \text{ mA}$ $I_{OH} = -8 \text{ mA}$
		3.0	2.58			2.48			
		4.5	3.94			3.80			
		$V_{OL}$	LOW Level Output Voltage	2.0		0.0	0.1		0.1
3.0				0.0	0.1		0.1		
4.5				0.0	0.1		0.1	V	$I_{OL} = 4 \text{ mA}$ $I_{OL} = 8 \text{ mA}$
3.0					0.36		0.44		
4.5					0.36		0.44		
$I_{IN}$	Input Leakage Current			0-5.5			±0.1		±1.0
$I_{CC}$	Quiescent Supply Current	5.5			2.0		20.0	μA	$V_{IN} = V_{CC}$ or GND

## Noise Characteristics

Symbol	Parameter	$V_{CC}$	$T_A = 25^\circ\text{C}$		Units	Conditions
			Typ	Limits		
$V_{OLP}$ (Note 6)	Quiet Output Maximum Dynamic $V_{OL}$	5.0	0.4	0.8	V	$C_L = 50 \text{ pF}$
$V_{OLV}$ (Note 6)	Quiet Output Minimum Dynamic $V_{OL}$	5.0	-0.4	-0.8	V	$C_L = 50 \text{ pF}$
$V_{IHD}$ (Note 6)	Minimum HIGH Level Dynamic Input Voltage	5.0		3.5	V	$C_L = 50 \text{ pF}$
$V_{ILD}$ (Note 6)	Maximum LOW Level Dynamic Input Voltage	5.0		1.5	V	$C_L = 50 \text{ pF}$

**Note 6:** Parameter guaranteed by design.

## AC Electrical Characteristics

Symbol	Parameter	V <sub>CC</sub>	T <sub>A</sub> = 25°C			T <sub>A</sub> = -40°C to +85°C		Units	Conditions
			Min	Typ	Max	Min	Max		
t <sub>PLH</sub>	Propagation Delay Time	3.3 ± 0.3		8.3	12.8	1.0	15.0	ns	C <sub>L</sub> = 15 pF
t <sub>PHL</sub>				10.8	16.3	1.0	18.5		C <sub>L</sub> = 50 pF
		5.0 ± 0.5		5.5	8.6	1.0	10.0	ns	C <sub>L</sub> = 15 pF
				7.0	10.6	1.0	12.0		C <sub>L</sub> = 50 pF
C <sub>IN</sub>	Input Capacitance			4	10		10	pF	V <sub>CC</sub> = Open
C <sub>PD</sub>	Power Dissipation Capacitance			21				pF	(Note 7)

**Note 7:** C<sub>PD</sub> is defined as the value of the internal equivalent capacitance which is calculated from the operating current consumption without load. Average operating current can be obtained by the equation:  $I_{CC}(\text{Opr}) = C_{PD} \cdot V_{CC} \cdot f_{IN} + I_{CC}/6$  (per Gate)

# Physical Dimensions

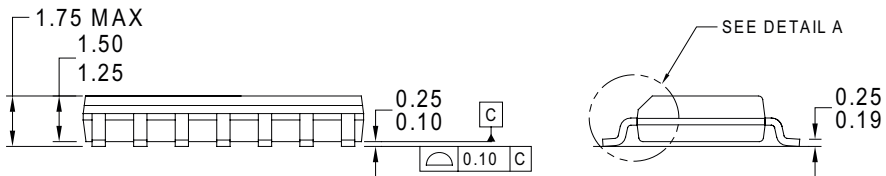
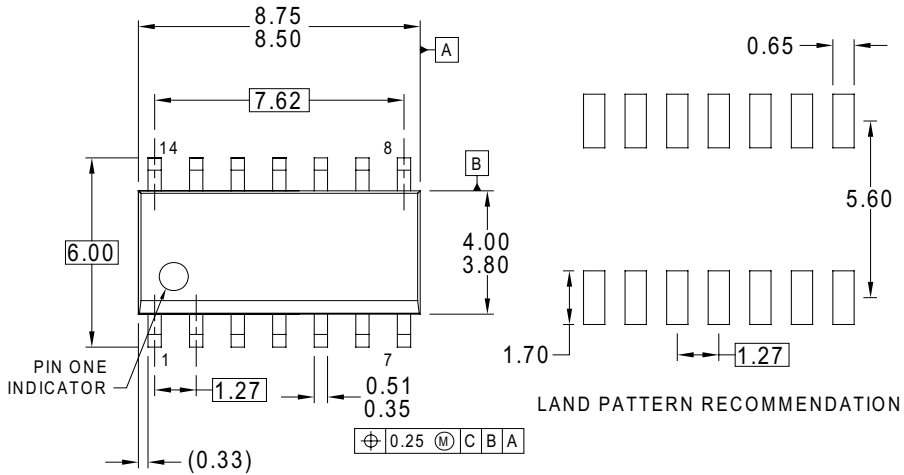

NOTES: UNLESS OTHERWISE SPECIFIED

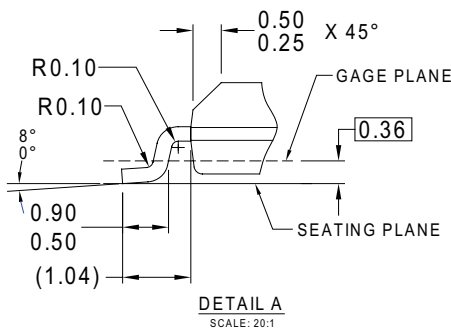

- A) THIS PACKAGE CONFORMS TO JEDEC MS-012, VARIATION AB, ISSUE C.
- B) ALL DIMENSIONS ARE IN MILLIMETERS.
- C) DIMENSIONS DO NOT INCLUDE MOLD FLASH OR BURRS.
- D) LANDPATTERN STANDARD:  
SOIC127P600X145-14M
- E) DRAWING CONFORMS TO ASME Y14.5M-1994
- F) DRAWING FILE NAME: M14AREV13

**14-Lead Small Outline Integrated Circuit (SOIC), JEDEC MS-012, 0.150" Narrow Package Number M14A**

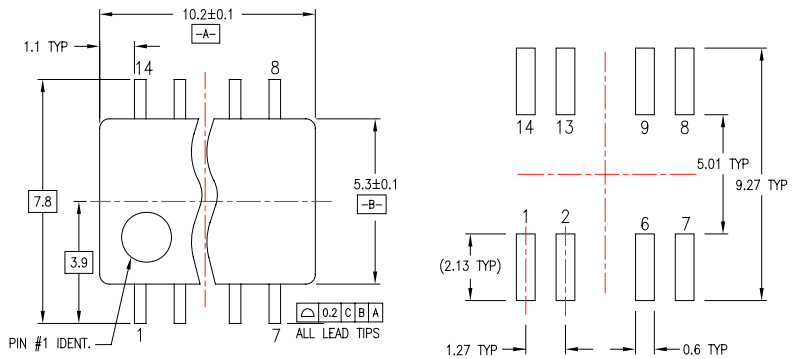

LAND PATTERN RECOMMENDATION

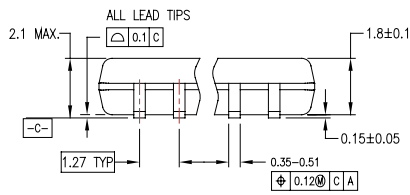

DIMENSIONS ARE IN MILLIMETERS

NOTES:

- A. CONFORMS TO EIAJ EDR-7320 REGISTRATION, ESTABLISHED IN DECEMBER, 1998.
- B. DIMENSIONS ARE IN MILLIMETERS.
- C. DIMENSIONS ARE EXCLUSIVE OF BURRS, MOLD FLASH, AND TIE BAR EXTRUSIONS.

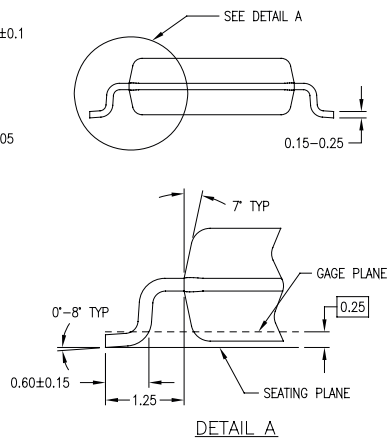

DETAIL A

M14DRFVC

**Pb-Free 14-Lead Small Outline Package (SOP), EIAJ TYPE II, 5.3mm Wide  
Package Number M14D**

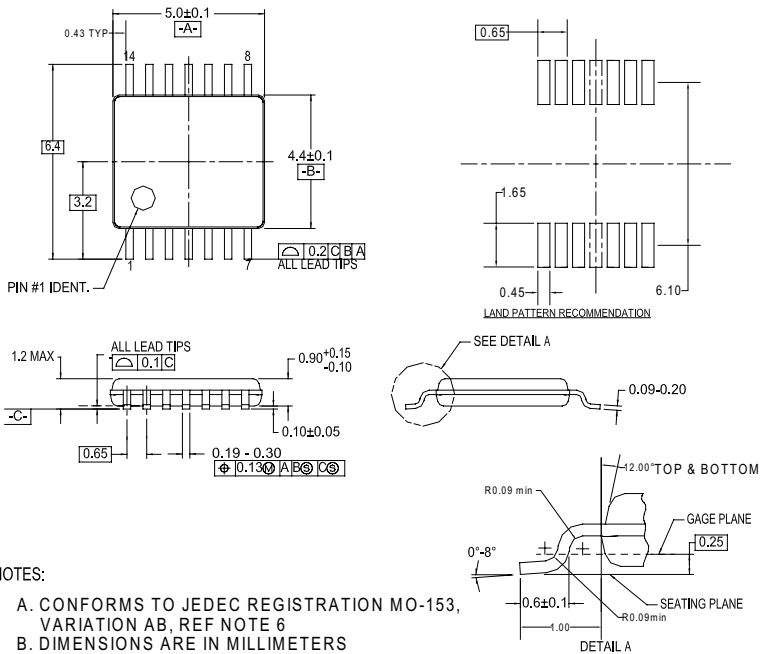

NOTES:

- A. CONFORMS TO JEDEC REGISTRATION MO-153, VARIATION AB, REF NOTE 6
- B. DIMENSIONS ARE IN MILLIMETERS
- C. DIMENSIONS ARE EXCLUSIVE OF BURRS, MOLD FLASH, AND TIE BAR EXTRUSIONS
- D. DIMENSIONING AND TOLERANCES PER ANSI Y14.5M, 1982
- E. LANDPATTERN STANDARD: SOP65P640X110-14M
- F. DRAWING FILE NAME: MTC14REV6

**14-Lead Thin Shrink Small Outline Package (TSSOP), JEDEC MO-153, 4.4mm Wide  
Package Number MTC14**

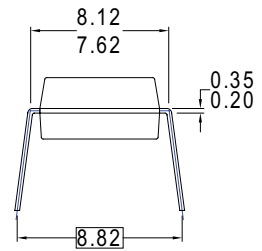
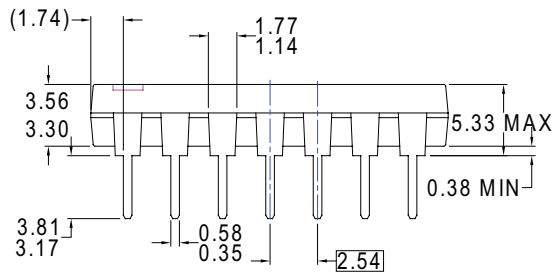
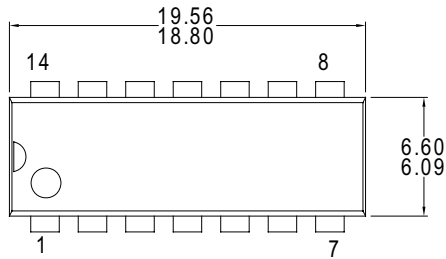

- NOTES: UNLESS OTHERWISE SPECIFIED  
 THIS PACKAGE CONFORMS TO  
 A) JEDEC MS-001 VARIATION BA  
 B) ALL DIMENSIONS ARE IN MILLIMETERS.  
 DIMENSIONS ARE EXCLUSIVE OF BURRS,  
 C) MOLD FLASH, AND TIE BAR EXTRUSIONS.  
 D) DIMENSIONS AND TOLERANCES PER  
 ASME Y14.5-1994  
 E) DRAWING FILE NAME: MKT-N14AREV7





**14-Lead Plastic Dual-In-Line Package (PDIP), JEDEC MS-001, 0.300" Wide  
 Package Number N14A**





### TRADEMARKS

The following includes registered and unregistered trademarks and service marks, owned by Fairchild Semiconductor and/or its global subsidiaries, and is not intended to be an exhaustive list of all such trademarks.

AccuPower™	F-PFS™	Power-SPM™	The Power Franchise®
Auto-SPM™	FRFET®	PowerTrench®	The Right Technology for Your Success™
AX-CAP™	Global Power Resource™	PowerXS™	
Build it Now™	Green FPS™	Programmable Active Droop™	<b>the power franchise</b>
CorePLUS™	Green FPS™ e-Series™	QFET®	TinyBoost™
CorePOWER™	Gmax™	QS™	TinyBuck™
CROSSVOL7™	GTO™	Quiet Series™	TinyCalc™
CTL™	IntelliMAX™	RapidConfigure™	TinyLogic®
Current Transfer Logic™	ISOPLANAR™		TINYOPTO™
DEUXPEED®	MegaBuck™	Saving our world, 1mW/W/kW at a time™	TinyPower™
Dual Cool™	MICROCOUPLER™	SignalWise™	TinyPWM™
EcoSPARK®	MicroFET™	SmartMax™	TinyWire™
EfficientMax™	MicroPak™	SMART START™	TriFault Detect™
ESBCT™	MicroPak2™	SPM®	TRUECURRENT™
	MillerDrive™	STEALTH™	µSerDes™
Fairchild®	MotionMax™	SuperFET®	
Fairchild Semiconductor®	Motion-SPM™	SuperSOT™-3	UHC®
FACT Quiet Series™	mVSAver™	SuperSOT™-6	Ultra FRFET™
FACT®	OptoHIT™	SuperSOT™-8	UniFET™
FAST®	OPTOLOGIC®	SupreMOS®	VCX™
FastvCore™	OPTOPLANAR®	SyncFET™	VisualMax™
FETBench™		Sync-Lock™	XS™
FlashWriter®	PDP SPM™		
FPS™			

\* Trademarks of System General Corporation, used under license by Fairchild Semiconductor.

### DISCLAIMER

FAIRCHILD SEMICONDUCTOR RESERVES THE RIGHT TO MAKE CHANGES WITHOUT FURTHER NOTICE TO ANY PRODUCTS HEREIN TO IMPROVE RELIABILITY, FUNCTION, OR DESIGN. FAIRCHILD DOES NOT ASSUME ANY LIABILITY ARISING OUT OF THE APPLICATION OR USE OF ANY PRODUCT OR CIRCUIT DESCRIBED HEREIN; NEITHER DOES IT CONVEY ANY LICENSE UNDER ITS PATENT RIGHTS, NOR THE RIGHTS OF OTHERS. THESE SPECIFICATIONS DO NOT EXPAND THE TERMS OF FAIRCHILD'S WORLDWIDE TERMS AND CONDITIONS, SPECIFICALLY THE WARRANTY THEREIN, WHICH COVERS THESE PRODUCTS.

### LIFE SUPPORT POLICY

FAIRCHILD'S PRODUCTS ARE NOT AUTHORIZED FOR USE AS CRITICAL COMPONENTS IN LIFE SUPPORT DEVICES OR SYSTEMS WITHOUT THE EXPRESS WRITTEN APPROVAL OF FAIRCHILD SEMICONDUCTOR CORPORATION.

As used herein:

1. Life support devices or systems are devices or systems which, (a) are intended for surgical implant into the body or (b) support or sustain life, and (c) whose failure to perform when properly used in accordance with instructions for use provided in the labeling, can be reasonably expected to result in a significant injury of the user.
2. A critical component in any component of a life support, device, or system whose failure to perform can be reasonably expected to cause the failure of the life support device or system, or to affect its safety or effectiveness.

### ANTI-COUNTERFEITING POLICY

Fairchild Semiconductor Corporation's Anti-Counterfeiting Policy. Fairchild's Anti-Counterfeiting Policy is also stated on our external website, [www.fairchildsemi.com](http://www.fairchildsemi.com), under Sales Support.

Counterfeiting of semiconductor parts is a growing problem in the industry. All manufacturers of semiconductor products are experiencing counterfeiting of their parts. Customers who inadvertently purchase counterfeit parts experience many problems such as loss of brand reputation, substandard performance, failed applications, and increased cost of production and manufacturing delays. Fairchild is taking strong measures to protect ourselves and our customers from the proliferation of counterfeit parts. Fairchild strongly encourages customers to purchase Fairchild parts either directly from Fairchild or from Authorized Fairchild Distributors who are listed by country on our web page cited above. Products customers buy either from Fairchild directly or from Authorized Fairchild Distributors are genuine parts, have full traceability, meet Fairchild's quality standards for handling and storage and provide access to Fairchild's full range of up-to-date technical and product information. Fairchild and our Authorized Distributors will stand behind all warranties and will appropriately address any warranty issues that may arise. Fairchild will not provide any warranty coverage or other assistance for parts bought from Unauthorized Sources. Fairchild is committed to combat this global problem and encourage our customers to do their part in stopping this practice by buying direct or from authorized distributors.

### PRODUCT STATUS DEFINITIONS

#### Definition of Terms

Datasheet Identification	Product Status	Definition
Advance Information	Formative / In Design	Datasheet contains the design specifications for product development. Specifications may change in any manner without notice.
Preliminary	First Production	Datasheet contains preliminary data, supplementary data will be published at a later date. Fairchild Semiconductor reserves the right to make changes at any time without notice to improve design.
No Identification Needed	Full Production	Datasheet contains final specifications. Fairchild Semiconductor reserves the right to make changes at any time without notice to improve the design.
Obsolete	Not In Production	Datasheet contains specifications on a product that is discontinued by Fairchild Semiconductor. The datasheet is for reference information only.

Rev. I52