

# SiC

Silicon Carbide Diode

## 2nd Generation thinQ!™

2nd Generation thinQ!™ SiC Schottky Diode  
IDY10S120

## Data Sheet

Rev. 2.1, 2011-05-25  
Final

Industrial & Multimarket

## 2nd Generation thinQ!™ SiC Schottky Diode

IDY10S120

### 1 Description

The second generation of Infineon SiC Schottky diodes has emerged over the years as the industry standard. The IDYxxS120 products are extending the already broad portfolio with the new TO-247HC (high creepage) package.

The new package layout is fully compatible with the industry standard TO247, and can therefore easily be placed in already existing designs, with no extra efforts.

The higher creepage distance increases the safety margin against the risk of short circuits, especially arcing, which might be triggered by the presence of dust or dirt inside the system. This reduces the need of additional chemical (silicone gel or creams) or mechanical (sheaths or foils) solutions to lower the pollution level between the leads, with all consequent benefits of a lean and faster manufacturing process

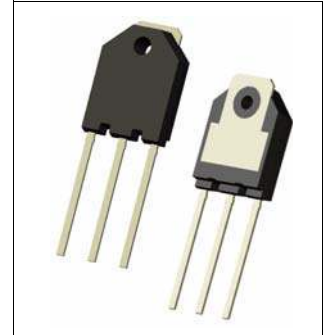

#### Features

- Revolutionary semiconductor material - Silicon Carbide
- Switching behavior benchmark
- No reverse recovery/ No forward recovery
- Temperature independent switching behavior
- High surge current capability
- Pb-free lead plating; RoHS compliant
- Qualified according to JEDEC<sup>1)</sup> for target applications
- Optimized for high temperature operation



#### Benefits

- System efficiency improvement over Si diodes
- System cost / size savings due to reduced cooling requirements
- Enabling higher frequency / increased power density solutions
- Higher system reliability due to lower operating temperatures and less fans
- Package design with high creepage distance
- Reduced EMI

#### Applications

- Solar applications; UPS; Motor Drives;
- SMPS e.g.; CCM PFC

**Table 1 Key Performance Parameters**

Parameter	Value	Unit
$V_{DC}$	1200	V
$Q_C$	36	nC
$I_F @ T_C < 150^\circ C$	10	A

**Table 2 Pin Definition**

Pin 1	Pin2	Pin 3
A	C	A

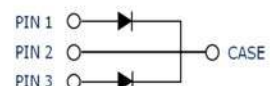

Type / Ordering Code	Package	Marking	Related Links
IDY10S120	PG-TO247HC-3	D10S120	<a href="#">IFX SiC Diodes Webpage</a>

1) J-STD20 and JESD22

## Table of Contents

1	Description .....	2
	Table of Contents .....	4
2	Maximum ratings .....	5
3	Thermal characteristics .....	5
4	Electrical characteristics .....	6
5	Electrical characteristics diagrams .....	7
6	Package outlines .....	10
7	Revision History .....	11

## 2 Maximum ratings

Table 3 Maximum ratings

Parameter	Symbol	Values (leg/device)			Unit	Note / Test Condition
		Min.	Typ.	Max.		
Continuous forward current	$I_F$	-	-	5/10	A	$T_C = < 150^\circ\text{C}$
Surge non-repetitive forward current, sine halfwave	$I_{F, SM}$	-	-	29/58		$T_C = 25^\circ\text{C}, t_p = 10 \text{ ms}$
		-	-	25/48		$T_C = 150^\circ\text{C}, t_p = 10 \text{ ms}$
Non-repetitive peak forward current	$I_{F, max}$	-	-	125/250		$T_C = 25^\circ\text{C}, t_p = 10 \mu\text{s}$
$i^2 t$ value	$\int i^2 dt$	-	-	4/16	A <sup>2</sup> s	$T_C = 25^\circ\text{C}, t_p = 10 \text{ ms}$
		-	-	3/12		$T_C = 150^\circ\text{C}, t_p = 10 \text{ ms}$
Repetitive peak reverse voltage	$V_{RRM}$	-	-	1200	V	$T_J = 25^\circ\text{C}$
Diode dv/dt ruggedness	dv/dt	-	-	50	V/ns	$V_R = 0 \dots 960 \text{ V}$
Power dissipation	$P_{tot}$	-	-	75/150	W	$T_C = 25^\circ\text{C}$
Operating and storage temperature	$T_j, T_{stg}$	-55	-	150	°C	
Mounting torque		-	-	0.6	Ncm	M3 screws Maximum of mounting processes:3

## 3 Thermal characteristics

Table 4 Thermal characteristics

Parameter	Symbol	Values (leg/device)			Unit	Note / Test Condition
		Min.	Typ.	Max.		
Thermal resistance, junction - case	$R_{thJC}$	-	-	2/1	K/W	leaded
Thermal resistance, junction - ambient	$R_{thJA}$	-	-	40		
Soldering temperature, wavesoldering only allowed at leads	$T_{sold}$	-	-	260	°C	1.6 mm (0.063 in.) from case for 10 s

## 4 Electrical characteristics

Electrical characteristics, at  $T_j=25\text{ °C}$ , unless otherwise specified.

**Table 5 Static characteristics**

Parameter	Symbol	Values (leg/device)			Unit	Note / Test Condition
		Min.	Typ.	Max.		
DC blocking voltage	$V_{DC}$	1200	-	-	V	$T_j = 25\text{ °C}$ , $I_R = 0.1\text{ mA}$
Diode forward voltage	$V_F$	-	1.65	1.8	V	$I_F = 10\text{ A}$ , $T_j = 25\text{ °C}$
		-	2.55			$I_F = 10\text{ A}$ , $T_j = 150\text{ °C}$
Reverse current	$I_R$	-	5/10	120/240	$\mu\text{A}$	$I_R = 1200\text{ V}$ , $T_j = 25\text{ °C}$
		-	20/40	500/1000		$I_R = 1200\text{ V}$ , $T_j = 150\text{ °C}$

**Table 6 AC characteristics**

Parameter	Symbol	Values (leg/device)			Unit	Note / Test Condition
		Min.	Typ.	Max.		
Total capacitive charge	$Q_c$	-	18/36	-	nC	$V_R = 400\text{ V}$ , $F \leq F_{max}$
Switching time <sup>1)</sup>	$t_c$	-	-	<10	ns	$di_F/dt = 200\text{ A}/\mu\text{s}$ , $T_j = 150\text{ °C}$
		$C$	-	250/500	-	$\text{pF}$
	-		20/40	-	$V_R = 300\text{ V}$ , $f = 1\text{ MHz}$	
	-		18/36	-	$V_R = 600\text{ V}$ , $f = 1\text{ MHz}$	

1)  $t_c$  is the time constant for the capacitive displacement current waveform (independent from  $T_j$ ,  $I_{LOAD}$  and  $di/dt$ ), different from  $t_{rr}$  which is dependent on  $T_j$ ,  $I_{LOAD}$  and  $di/dt$ . No reverse recovery time constant  $t_{rr}$  due to absence of minority carrier injection.

## 5 Electrical characteristics diagrams

Electrical characteristics, at  $T_j=25\text{ °C}$ , unless otherwise specified.

Table 7

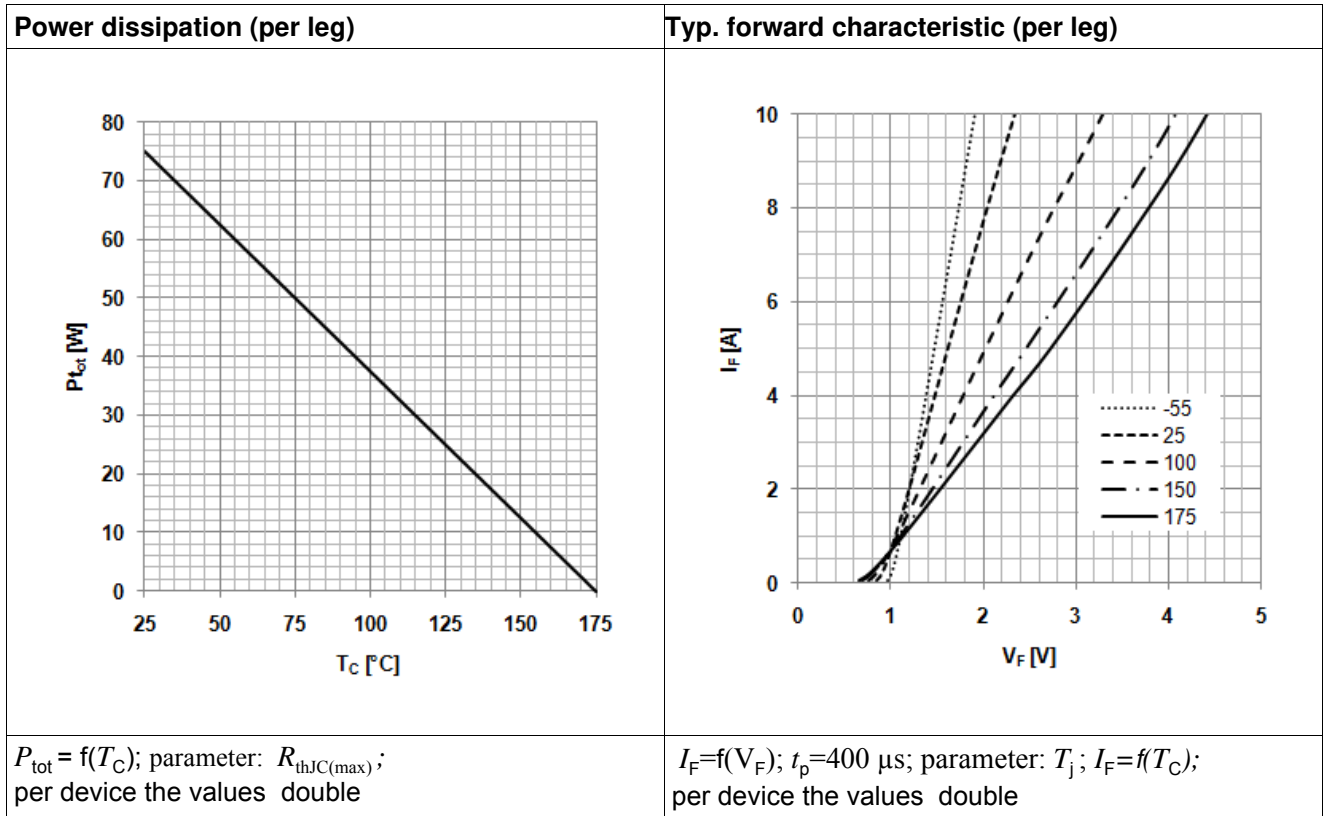
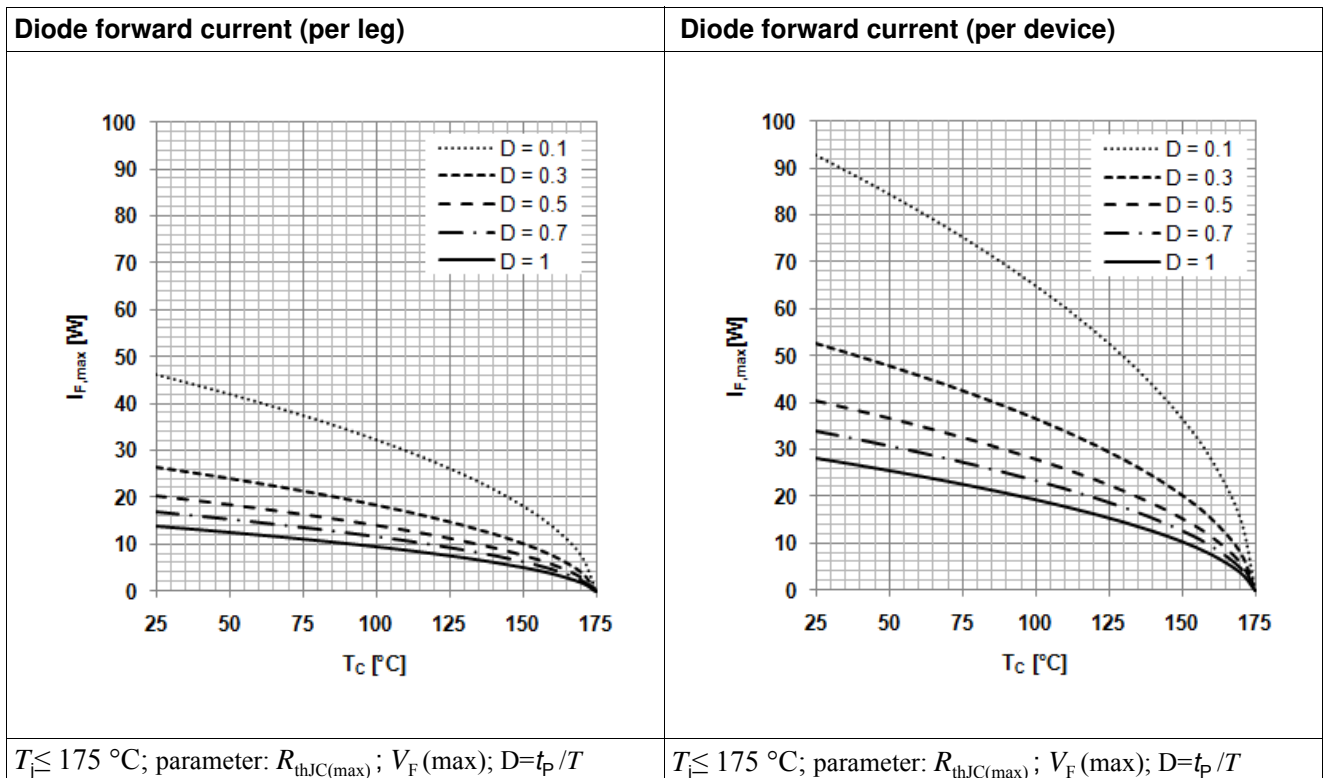

Table 8



Electrical characteristics diagrams

Table 9

Typ. capacitance charge vs. current slope <sup>1)</sup> (per leg)	Typ. reverse current vs. reverse voltage (per leg)
<p><math>Q_D = f(diF/dt)</math>; <math>T_j = 150\text{ °C}</math>; <math>I_F \leq I_{F\text{ max}}</math> per device the values double</p>	<p><math>I_R = f(V_R)</math>; parameter: <math>T_j</math>; per device the values double</p>

1) Only capacitive charge occurring, guaranteed by design

Table 10

Typ. transient thermal impedance (per leg)	Typ. transient thermal impedance (per device)
<p><math>Z_{thjc} = f(t_p)</math>; parameter: <math>D = t_p / T</math></p>	<p><math>Z_{thjc} = f(t_p)</math>; parameter: <math>D = t_p / T</math></p>

Table 11

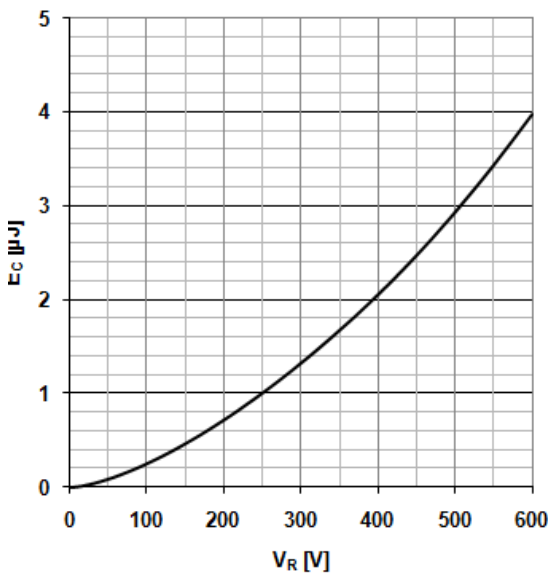
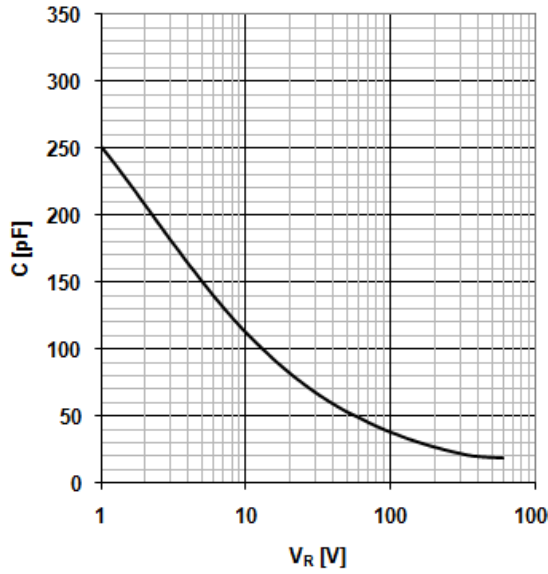
Typ. C stored energy (per leg)	Typ. capacitance vs. reverse voltage (per leg)
	
<p><math>E_C=f(V_R)</math>; per device the values double</p>	<p><math>C=f(V_R)</math>; <math>T_C=25\text{ }^\circ\text{C}</math>, <math>f=1\text{ MHz}</math>; per device the values double</p>



6 Package outlines

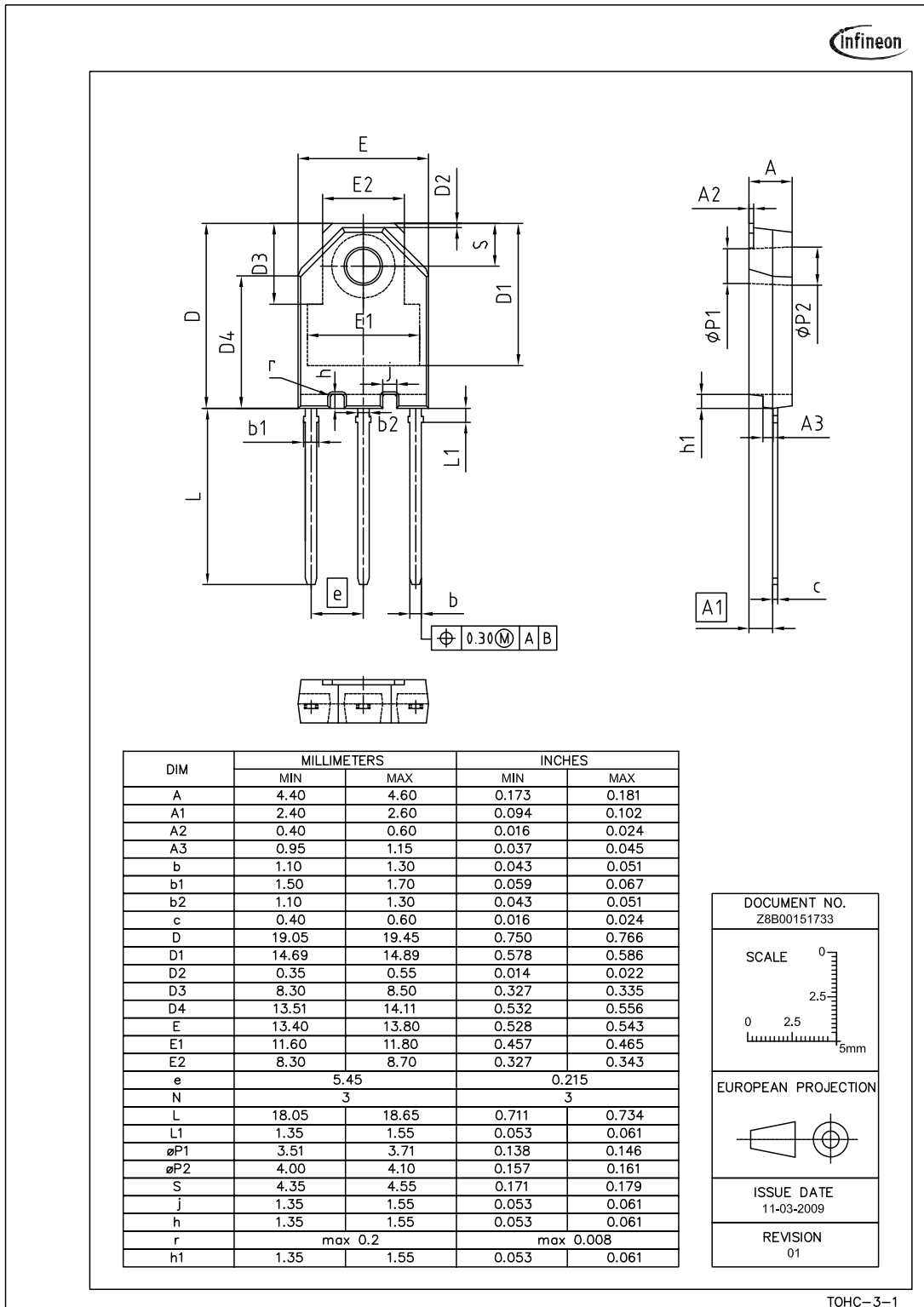

Figure 1 Dimensions in mm/inches

## 7 Revision History

### 2nd Generation thinQ!™ 2nd Generation thinQ!™ SiC Schottky Diode

Revision History: 2011-05-25, Rev. 2.1

#### Previous Revision:

Revision	Subjects (major changes since last revision)
2.0	Release of final data sheet
2.1	Update of Total capacitive charge

#### We Listen to Your Comments

Any information within this document that you feel is wrong, unclear or missing at all?  
Your feedback will help us to continuously improve the quality of this document.

Please send your proposal (including a reference to this document) to: [erratum@infineon.com](mailto:erratum@infineon.com)



Edition 2011-05-25

Published by  
Infineon Technologies AG  
81726 Munich, Germany

© 2011 Infineon Technologies AG  
All Rights Reserved.

#### Legal Disclaimer

The information given in this document shall in no event be regarded as a guarantee of conditions or characteristics. With respect to any examples or hints given herein, any typical values stated herein and/or any information regarding the application of the device, Infineon Technologies hereby disclaims any and all warranties and liabilities of any kind, including without limitation, warranties of non-infringement of intellectual property rights of any third party.

#### Information

For further information on technology, delivery terms and conditions and prices, please contact the nearest Infineon Technologies Office ([www.infineon.com](http://www.infineon.com)).

#### Warnings

Due to technical requirements, components may contain dangerous substances. For information on the types in question, please contact the nearest Infineon Technologies Office.

The Infineon Technologies component described in this Data Sheet may be used in life-support devices or systems and/or automotive, aviation and aerospace applications or systems only with the express written approval of Infineon Technologies, if a failure of such components can reasonably be expected to cause the failure of that life-support, automotive, aviation and aerospace device or system or to affect the safety or effectiveness of that device or system. Life support devices or systems are intended to be implanted in the human body or to support and/or maintain and sustain and/or protect human life. If they fail, it is reasonable to assume that the health of the user or other persons may be endangered.