

FKCOR 2,5/ 4-ST-5,08-LR - PCB connector



1861713

<https://www.phoenixcontact.com/us/products/1861713>

Please be informed that the data shown in this PDF document is generated from our online catalog. Please find the complete data in the user documentation. Our general terms of use for downloads are valid.



PCB connector, nominal cross section: 2.5 mm², color: green, nominal current: 12 A, rated voltage (III/2): 320 V, contact surface: Tin, contact connection type: Socket, number of potentials: 4, number of rows: 1, number of positions: 4, number of connections: 4, product range: FKCOR 2,5/...-ST-LR, pitch: 5.08 mm, connection method: Push-in spring connection, conductor/PCB connection direction: 90 °, locking clip: - Locking clip, plug-in system: COMBICON MSTB 2,5, locking: Snap-in locking, mounting: Lock & Release ejector lever, type of packaging: packed in cardboard

Your advantages

- The conductor connection orthogonal to the direction of operation simplifies the cabling of DIN-rail-mountable devices
- Time saving push-in connection, tools not required
- Intuitive use through colour coded actuation lever
- Automatic locking and intuitive release through Lock and Release operating lever in contrasting color
- Can be combined with the MSTB 2,5 range

Commercial data

Item number	1861713
Packing unit	1 pc
Minimum order quantity	250 pc
Note	Made to order (non-returnable)
Sales key	AA03
Product key	AACFGE
GTIN	4055626124599
Weight per piece (including packing)	6.222 g
Weight per piece (excluding packing)	6 g
Customs tariff number	85366990
Country of origin	PL

1861713

<https://www.phoenixcontact.com/us/products/1861713>

Technical data

Product properties

Product line	COMBICON Connectors M
Product type	PCB connector
Product family	FKCOR 2,5/...-ST-LR
Number of positions	4
Pitch	5.08 mm
Number of connections	4
Number of rows	1
Number of potentials	4

Electrical properties

Nominal current I_N	12 A
Nominal voltage U_N	320 V
Degree of pollution	3
Contact resistance	1.3 m Ω
Rated voltage (III/3)	250 V
Rated surge voltage (III/3)	4 kV
Rated voltage (III/2)	320 V
Rated surge voltage (III/2)	4 kV
Rated voltage (II/2)	630 V
Rated surge voltage (II/2)	4 kV

Connection data

Connection technology

Connector system	COMBICON MSTB 2,5
Nominal cross section	2.5 mm ²
Contact connection type	Socket

Interlock

Locking type	Snap-in locking
Mounting flange	Lock & Release ejector lever

Conductor connection

Connection method	Push-in spring connection
Conductor/PCB connection direction	90 °
Conductor cross section rigid	0.2 mm ² ... 2.5 mm ²
Conductor cross section flexible	0.2 mm ² ... 2.5 mm ²
Conductor cross section AWG	24 ... 12
Conductor cross section flexible, with ferrule without plastic sleeve	0.25 mm ² ... 2.5 mm ²
Conductor cross section, flexible, with ferrule, with plastic sleeve	0.14 mm ² ... 2.5 mm ²
Cylindrical gauge a x b / diameter	2.8 mm x 2.0 mm / 2.3 mm

FKCOR 2,5/ 4-ST-5,08-LR - PCB connector



1861713

<https://www.phoenixcontact.com/us/products/1861713>

Stripping length	10 mm
------------------	-------

Specifications for ferrules without insulating collar

recommended crimping tool	1212034 CRIMPFOX 6
ferrules without insulating collar, according to DIN 46228-1	Cross section: 0.25 mm ² ; Length: 7 mm
	Cross section: 0.34 mm ² ; Length: 7 mm
	Cross section: 0.5 mm ² ; Length: 8 mm ... 10 mm
	Cross section: 0.75 mm ² ; Length: 8 mm ... 10 mm
	Cross section: 1 mm ² ; Length: 8 mm ... 10 mm
	Cross section: 1.5 mm ² ; Length: 8 mm ... 10 mm
	Cross section: 2.5 mm ² ; Length: 8 mm ... 10 mm

Specifications for ferrules with insulating collar

recommended crimping tool	1212034 CRIMPFOX 6
ferrules with insulating collar, according to DIN 46228-4	Cross section: 0.14 mm ² ; Length: 8 mm
	Cross section: 0.25 mm ² ; Length: 8 mm ... 10 mm
	Cross section: 0.34 mm ² ; Length: 8 mm ... 10 mm
	Cross section: 0.5 mm ² ; Length: 8 mm ... 10 mm
	Cross section: 0.75 mm ² ; Length: 8 mm ... 10 mm
	Cross section: 1.5 mm ² ; Length: 8 mm ... 10 mm
	Cross section: 2.5 mm ² ; Length: 10 mm

Material specifications

Material data - contact

Note	WEEE/RoHS-compliant, free of whiskers according to IEC 60068-2-82/JEDEC JESD 201
Contact material	Cu alloy
Surface characteristics	hot-dip tin-plated
Metal surface terminal point (top layer)	Tin (4 - 8 µm Sn)
Metal surface contact area (top layer)	Tin (4 - 8 µm Sn)

Material data - housing

Color (Housing)	green (6021)
Insulating material	PA
Insulating material group	I
CTI according to IEC 60112	600
Flammability rating according to UL 94	V0
Glow wire flammability index GWFI according to EN 60695-2-12	850
Glow wire ignition temperature GWIT according to EN 60695-2-13	775
Temperature for the ball pressure test according to EN 60695-10-2	125 °C

Material data – actuating element

Insulating material	PBT
Insulating material group	IIIa

FKCOR 2,5/ 4-ST-5,08-LR - PCB connector



1861713

<https://www.phoenixcontact.com/us/products/1861713>

CTI according to IEC 60112	275
Flammability rating according to UL 94	V0

Dimensions

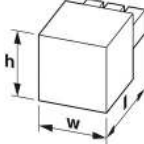
Dimensional drawing	
Pitch	5.08 mm
Width [w]	29.32 mm
Height [h]	14.7 mm
Length [l]	29.1 mm

Mounting

Connection method	Push-in spring connection
-------------------	---------------------------

Notes

Notes on operation	In accordance with IEC 61984, COMBICON connectors have no switching power (COC). During designated use, they must not be plugged in or disconnected when carrying voltage or under load.
--------------------	--

Mechanical tests

Conductor connection

Specification	IEC 60999-1:1999-11
Result	Test passed

Test for conductor damage and slackening

Specification	IEC 60999-1:1999-11
Result	Test passed

Repeated connection and disconnection

Specification	IEC 60999-1:1999-11
Result	Test passed

Pull-out test

Specification	IEC 60999-1:1999-11
Conductor cross section/conductor type/tractive force setpoint/actual value	0.2 mm ² / solid / > 10 N
	0.2 mm ² / flexible / > 10 N
	2.5 mm ² / solid / > 50 N
	2.5 mm ² / flexible / > 50 N

Insertion and withdrawal forces

Result	Test passed
No. of cycles	25
Insertion strength per pos. approx.	8 N

FKCOR 2,5/ 4-ST-5,08-LR - PCB connector



1861713

<https://www.phoenixcontact.com/us/products/1861713>

Withdraw strength per pos. approx.	11 N
Resistance of inscriptions	
Specification	IEC 60068-2-70:1995-12
Result	Test passed
Polarization and coding	
Specification	IEC 60512-13-5:2006-02
Result	Test passed
Visual inspection	
Specification	IEC 60512-1-1:2002-02
Result	Test passed
Dimension check	
Specification	IEC 60512-1-2:2002-02
Result	Test passed

Environmental and real-life conditions

Vibration test

Specification	IEC 60068-2-6:2007-12
Frequency	10 - 150 - 10 Hz
Sweep speed	1 octave/min
Amplitude	0.35 mm (10 Hz ... 60.1 Hz)
Sweep speed	5g (60.1 Hz ... 150 Hz)
Test duration per axis	2.5 h

Durability test

Specification	IEC 60512-9-1:2010-03
Impulse withstand voltage at sea level	4.8 kV
Contact resistance R_1	1.3 m Ω
Contact resistance R_2	1.3 m Ω
Insertion/withdrawal cycles	25
Insulation resistance, neighboring positions	> 5 M Ω

Climatic test

Specification	ISO 6988:1985-02
Corrosive stress	0.2 dm ³ SO ₂ on 300 dm ³ /40 °C/1 cycle
Thermal stress	100 °C/168 h
Power-frequency withstand voltage	2.21 kV

Shocks

Specification	IEC 60068-2-27:2008-02
Pulse shape	Semi-sinusoidal
Acceleration	30g
Shock duration	18 ms
Test directions	X-, Y- and Z-axis (pos. and neg.)

FKCOR 2,5/ 4-ST-5,08-LR - PCB connector



1861713

<https://www.phoenixcontact.com/us/products/1861713>

Ambient conditions

Ambient temperature (operation)	-40 °C ... 100 °C (dependent on the derating curve)
Ambient temperature (storage/transport)	-40 °C ... 70 °C
Relative humidity (storage/transport)	30 % ... 70 %
Ambient temperature (assembly)	-5 °C ... 100 °C

Electrical tests

Thermal test | Test group C

Specification	IEC 60512-5-1:2002-02
Tested number of positions	24

Insulation resistance

Specification	IEC 60512-3-1:2002-02
Insulation resistance, neighboring positions	> 5 MΩ

Air clearances and creepage distances |

Specification	IEC 60664-1:2007-04
Insulating material group	I
Comparative tracking index (IEC 60112)	CTI 600
Rated insulation voltage (III/3)	250 V
Rated surge voltage (III/3)	4 kV
minimum clearance value - non-homogenous field (III/3)	3 mm
minimum creepage distance (III/3)	3.2 mm
Rated insulation voltage (III/2)	320 V
Rated surge voltage (III/2)	4 kV
minimum clearance value - non-homogenous field (III/2)	3 mm
minimum creepage distance (III/2)	3 mm
Rated insulation voltage (II/2)	630 V
Rated surge voltage (II/2)	4 kV
minimum clearance value - non-homogenous field (II/2)	3 mm
minimum creepage distance (II/2)	3.2 mm

Packaging specifications

Type of packaging	packed in cardboard
-------------------	---------------------

Drawings

Diagram

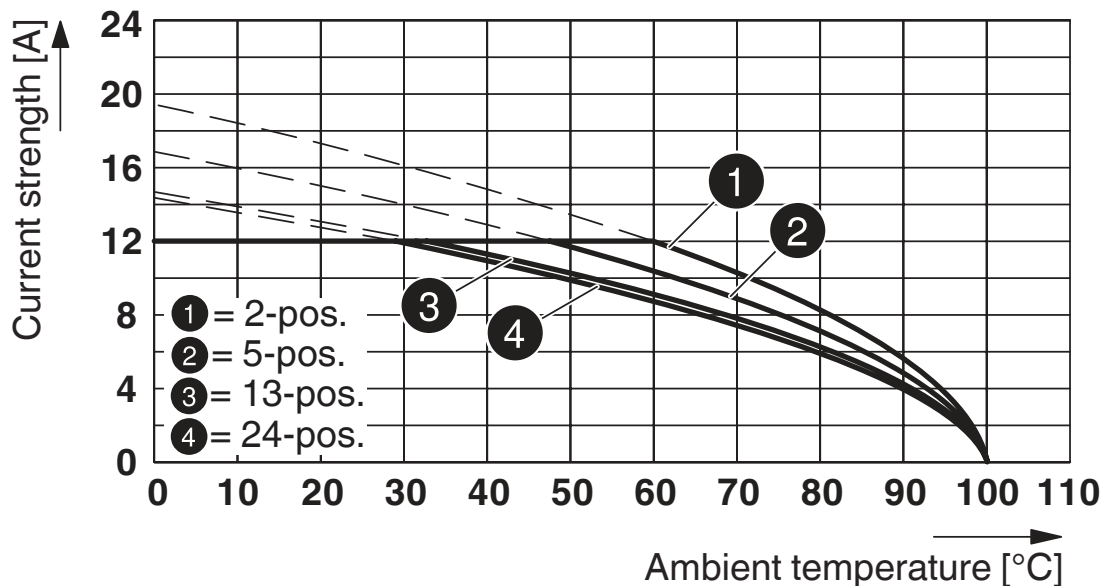

Type: FKCO(R/W) 2,5/...-ST-5,08(-LR) with MSTBVA 2,5/...-ST-5,08(-LR)

Diagram

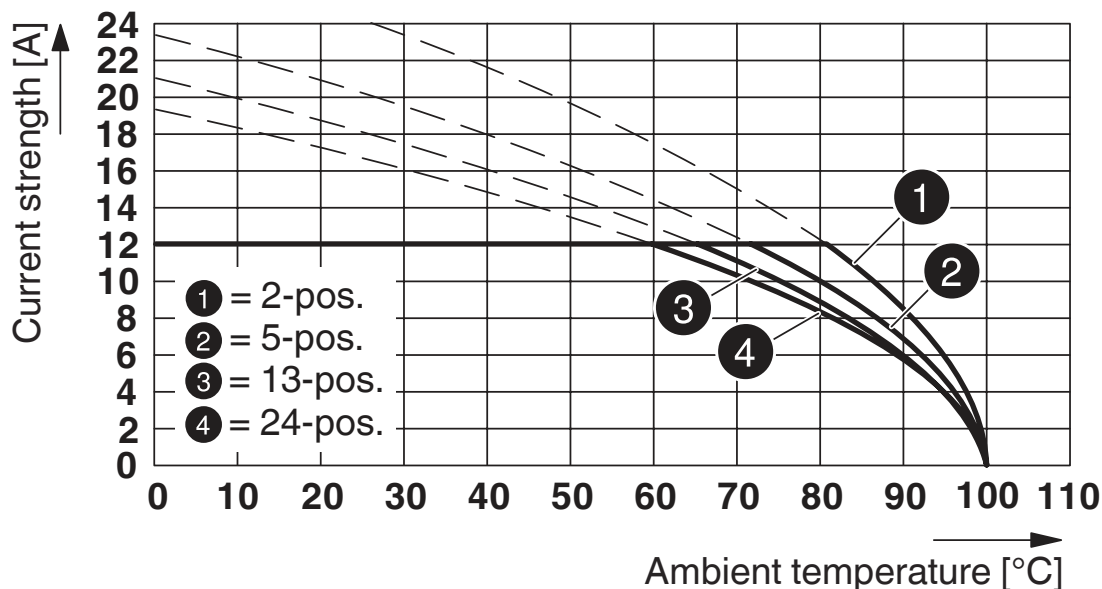

Type: FKCO(R/W) 2,5/...-ST-5,08-LR with MSTBA(R/W) 2,5/...-G-5,08-LR

FKCOR 2,5/ 4-ST-5,08-LR - PCB connector





1861713

<https://www.phoenixcontact.com/us/products/1861713>

Approvals

To download certificates, visit the product detail page: <https://www.phoenixcontact.com/us/products/1861713>

 cULus Recognized Approval ID: E60425-19931011				
	Nominal voltage U_N	Nominal current I_N	Cross section AWG	Cross section mm^2
Use group B	300 V	12 A	26 - 12	-
Use group D	300 V	10 A	26 - 12	-

 EAC Approval ID: B.01687				
--	--	--	--	--

 UL Recognized Approval ID: E60425-19931011				
	Nominal voltage U_N	Nominal current I_N	Cross section AWG	Cross section mm^2
Use group F	300 V	12 A	26 - 12	-

FKCOR 2,5/ 4-ST-5,08-LR - PCB connector



1861713

<https://www.phoenixcontact.com/us/products/1861713>

Classifications

ECLASS

ECLASS-11.0	27460202
ECLASS-12.0	27460202
ECLASS-13.0	27460202

ETIM

ETIM 8.0	EC002638
----------	----------

UNSPSC

UNSPSC 21.0	39121400
-------------	----------

FKCOR 2,5/ 4-ST-5,08-LR - PCB connector



1861713

<https://www.phoenixcontact.com/us/products/1861713>

Environmental product compliance

China RoHS	Environmentally friendly use period: unlimited = EFUP-e
	No hazardous substances above threshold values

FKCOR 2,5/ 4-ST-5,08-LR - PCB connector

1861713

<https://www.phoenixcontact.com/us/products/1861713>

Accessories

CP-MSTB - Coding profile

1734634

<https://www.phoenixcontact.com/us/products/1734634>

Coding profile, is inserted into the slot on the plug or inverted header, red insulating material



SZS 0,6X3,5 - Screwdriver

1205053

<https://www.phoenixcontact.com/us/products/1205053>

Actuation tool, for ST terminal blocks, insulated, also suitable for use as a bladed screwdriver, size: 0.6 x 3.5 x 100 mm, 2-component grip, with non-slip grip



FKCOR 2,5/ 4-ST-5,08-LR - PCB connector



1861713

<https://www.phoenixcontact.com/us/products/1861713>

SK 5,08/3,8:FORTL.ZAHLEN - Marker card

0804293

<https://www.phoenixcontact.com/us/products/0804293>



Marker card, white, labeled, horizontal: consecutive numbers 1 ... 10, 11 ... 20, etc. up to 91 ... (99)100, mounting type: adhesive, for terminal block width: 5.08 mm, lettering field size: 5.08 x 3.8 mm

CC 2,5/ 4-GF-5,08-LR P26THR - PCB header

1792643

<https://www.phoenixcontact.com/us/products/1792643>



PCB headers, nominal cross section: 2.5 mm², color: black, nominal current: 12 A, rated voltage (III/2): 320 V, contact surface: Tin, contact connection type: Pin, number of potentials: 4, number of rows: 1, number of positions: 4, number of connections: 4, product range: CC 2,5/..-GF-LR, pitch: 5.08 mm, mounting: THR soldering, pin layout: Linear pinning, solder pin [P]: 2.6 mm, number of solder pins per potential: 1, plug-in system: COMBICON MSTB 2,5, Pin connector pattern alignment: Standard, locking: Snap-in locking, mounting: Lock & release threaded flange, type of packaging: packed in cardboard

FKCOR 2,5/ 4-ST-5,08-LR - PCB connector



1861713

<https://www.phoenixcontact.com/us/products/1861713>

CCV 2,5/ 4-GF-5,08-LR P26THR - PCB header

1792753

<https://www.phoenixcontact.com/us/products/1792753>



PCB headers, nominal cross section: 2.5 mm², color: black, nominal current: 12 A, rated voltage (III/2): 320 V, contact surface: Tin, contact connection type: Pin, number of potentials: 4, number of rows: 1, number of positions: 4, number of connections: 4, product range: CCV 2,5/..-GF-LR, pitch: 5.08 mm, mounting: THR soldering, pin layout: Linear pinning, solder pin [P]: 2.6 mm, number of solder pins per potential: 1, plug-in system: COMBICON MSTB 2,5, Pin connector pattern alignment: Standard, locking: Snap-in locking, mounting: Lock & release threaded flange, type of packaging: packed in cardboard

MSTBA 2,5/ 4-G-5,08-LR - PCB header

1809092

<https://www.phoenixcontact.com/us/products/1809092>

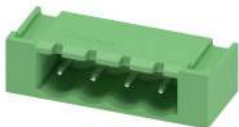

PCB headers, nominal cross section: 2.5 mm², color: green, nominal current: 12 A, rated voltage (III/2): 320 V, contact surface: Tin, contact connection type: Pin, number of potentials: 4, number of rows: 1, number of positions: 4, number of connections: 4, product range: MSTBA 2,5/..-G-LR, pitch: 5.08 mm, mounting: Wave soldering, pin layout: Linear pinning, solder pin [P]: 3.5 mm, number of solder pins per potential: 1, plug-in system: COMBICON MSTB 2,5, Pin connector pattern alignment: Standard, locking: Snap-in locking, mounting: Lock & Release, type of packaging: packed in cardboard

FKCOR 2,5/ 4-ST-5,08-LR - PCB connector



1861713

<https://www.phoenixcontact.com/us/products/1861713>

MSTBVA 2,5/ 4-G-5,08-LR - PCB header

1809283

<https://www.phoenixcontact.com/us/products/1809283>

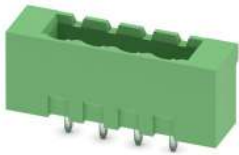

PCB headers, nominal cross section: 2.5 mm², color: green, nominal current: 12 A, rated voltage (III/2): 320 V, contact surface: Tin, contact connection type: Pin, number of potentials: 4, number of rows: 1, number of positions: 4, number of connections: 4, product range: MSTBVA 2,5/..-G-LR, pitch: 5.08 mm, mounting: Wave soldering, pin layout: Linear pinning, solder pin [P]: 3.9 mm, number of solder pins per potential: 1, plug-in system: COMBICON MSTB 2,5, Pin connector pattern alignment: Standard, locking: Snap-in locking, mounting: Lock & Release, type of packaging: packed in cardboard

Phoenix Contact 2023 © - all rights reserved

<https://www.phoenixcontact.com>

Phoenix Contact USA
586 Fulling Mill Road
Middletown, PA 17057, United States
(+717) 944-1300
info@phoenixcon.com