

## Inductors for power circuits

## Wound ferrite

## VLS-EX series



## VLS5045EX type



## FEATURES

- Magnetic shield type wound inductor for power circuits.
- High magnetic shield construction achieved by a ferrite magnetic material and compatible with high-density mounting.
- Larger current and lower Rdc were achieved by optimizing the ferrite core figure.

## APPLICATION

- TV, STB, gaming equipment, other AV equipment

## PART NUMBER CONSTRUCTION

<b>VLS</b>	<b>5045</b>	<b>EX</b>	-	<b>1R0</b>	<b>N</b>
Series name	L×W×H dimensions 5.0×5.0×4.5 mm	Internal code		Inductance (μH)	Inductance tolerance

## CHARACTERISTICS SPECIFICATION TABLE

L (μH)	Tolerance	Measuring frequency (kHz)	DC resistance		Rated current*		Part No.
			typ. (Ω)±30%		Isat (A)max.	Itemp (A)typ.	
1.0	±30%	100	0.015		8.90	5.10	<a href="#">VLS5045EX-1R0N</a>
1.5	±30%	100	0.017		7.40	5.00	<a href="#">VLS5045EX-1R5N</a>
2.2	±30%	100	0.022		6.40	4.70	<a href="#">VLS5045EX-2R2N</a>
3.3	±30%	100	0.027		5.20	4.20	<a href="#">VLS5045EX-3R3N</a>
4.7	±20%	100	0.036		4.40	3.20	<a href="#">VLS5045EX-4R7M</a>
6.8	±20%	100	0.046		3.60	2.90	<a href="#">VLS5045EX-6R8M</a>
10	±20%	100	0.061		3.10	2.50	<a href="#">VLS5045EX-100M</a>
15	±20%	100	0.110		2.20	1.90	<a href="#">VLS5045EX-150M</a>
22	±20%	100	0.125		2.00	1.80	<a href="#">VLS5045EX-220M</a>
33	±20%	100	0.240		1.50	1.30	<a href="#">VLS5045EX-330M</a>
47	±20%	100	0.300		1.30	1.00	<a href="#">VLS5045EX-470M</a>
68	±20%	100	0.410		1.10	0.90	<a href="#">VLS5045EX-680M</a>
100	±20%	100	0.580		0.80	0.70	<a href="#">VLS5045EX-101M</a>
150	±20%	100	0.730		0.56	0.61	<a href="#">VLS5045EX-151M</a>
220	±20%	100	1.050		0.45	0.45	<a href="#">VLS5045EX-221M</a>

\* Rated current: smaller value of either Isat or Itemp.

Isat: When based on the inductance change rate (30% below the initial L value)

Itemp: When based on the temperature increase (temperature increase of 40°C by self heating)

Measurement equipment

Measurement item	Product No.	Manufacturer
L	4194A	Keysight Technologies, Inc. (formerly Hewlett-Packard)
DC resistance	VP-2941A	Panasonic (formerly Matsushita Electric Industrial)
Rated current Isat	4284A+42841A+42842A	Keysight Technologies, Inc. (formerly Hewlett-Packard)

\* Equivalent measurement equipment may be used.



# VLS5045EX type

## L FREQUENCY CHARACTERISTICS

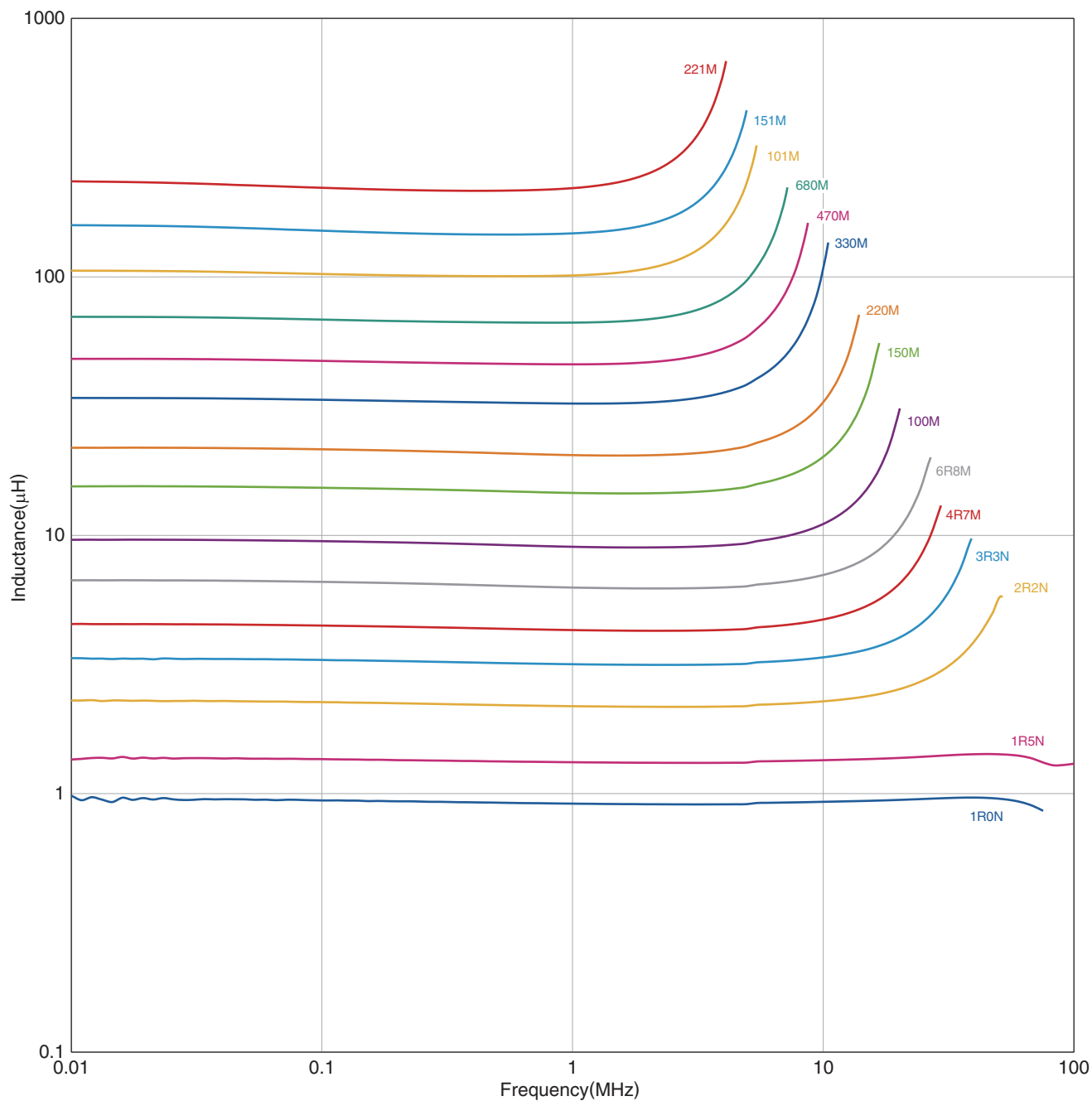

□ Measurement equipment

Product No.	Manufacturer
4284A+42841A+42842A	Keysight Technologies, Inc. (formerly Hewlett-Packard)

\* Equivalent measurement equipment may be used.

# VLS5045EX type

## ■ INDUCTANCE VS. DC BIAS CHARACTERISTICS

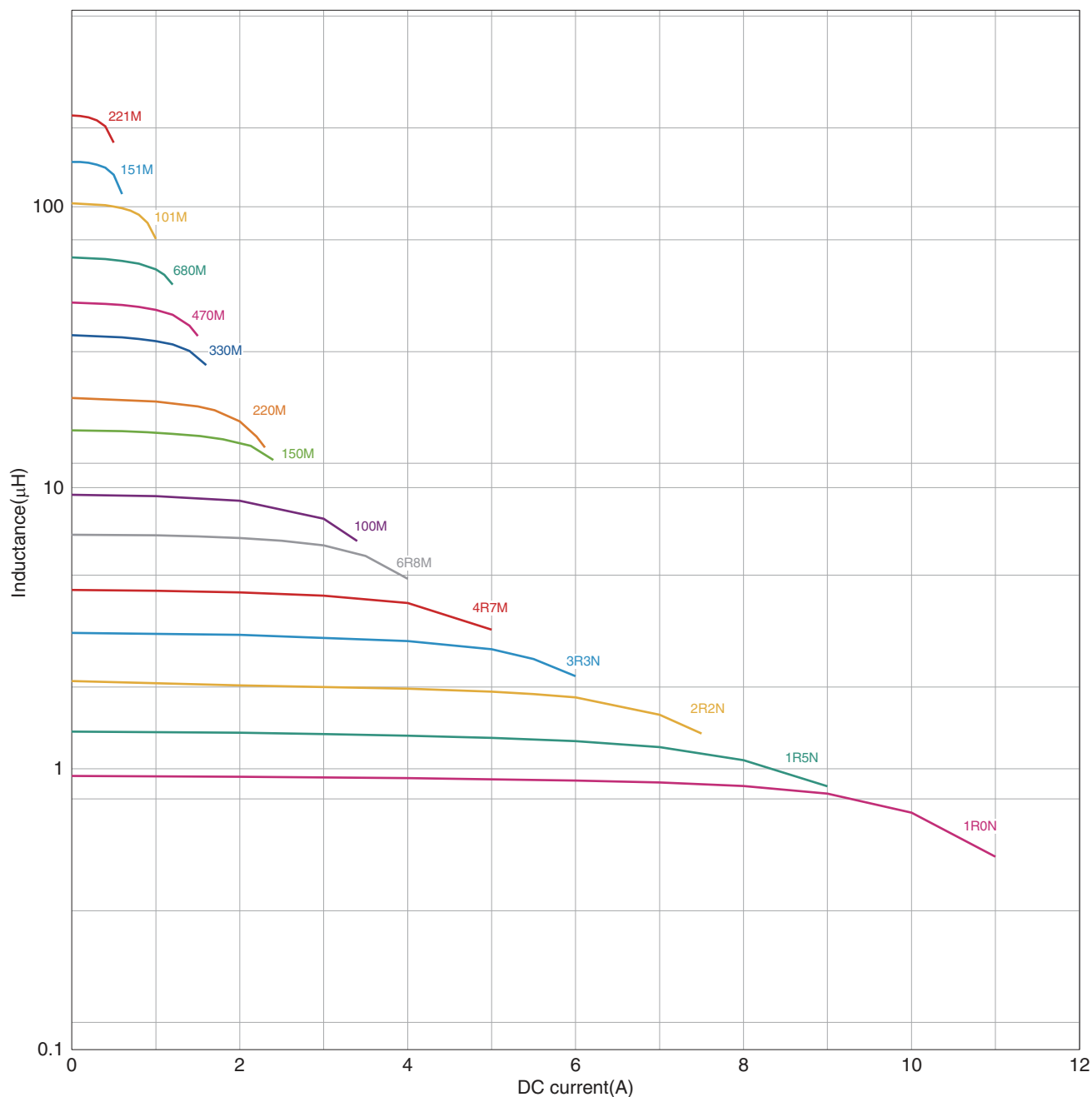

□ Measurement equipment

Product No.	Manufacturer
4285A+42841A+42842C	Keysight Technologies, Inc. (formerly Hewlett-Packard)

\* Equivalent measurement equipment may be used.

# VLS5045EX type

## SHAPE & DIMENSIONS

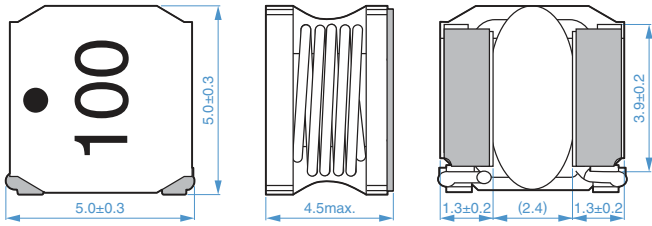

## PACKAGING STYLE

### REEL DIMENSIONS

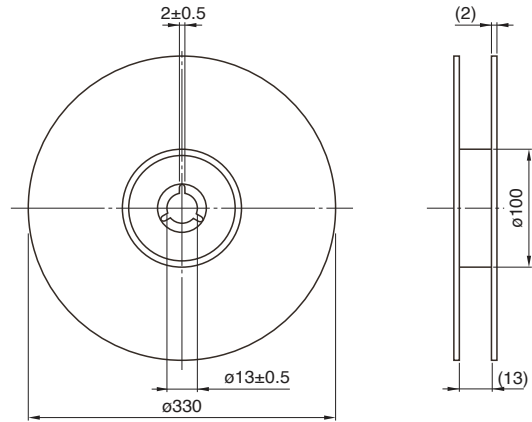

Dimensions in mm

## RECOMMENDED LAND PATTERN

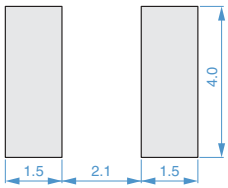

### TAPE DIMENSIONS

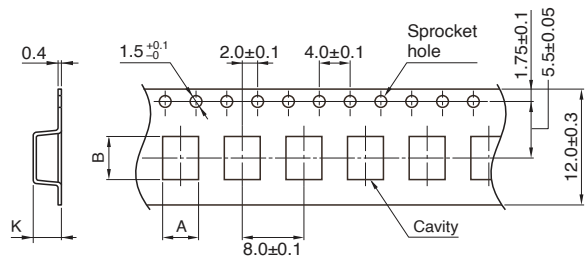

Dimensions in mm

Type	A	B	K
VLS5045EX	5.3	5.3	4.7

### PACKAGE QUANTITY

Package quantity	1500 pcs/reel
------------------	---------------

## RECOMMENDED REFLOW PROFILE

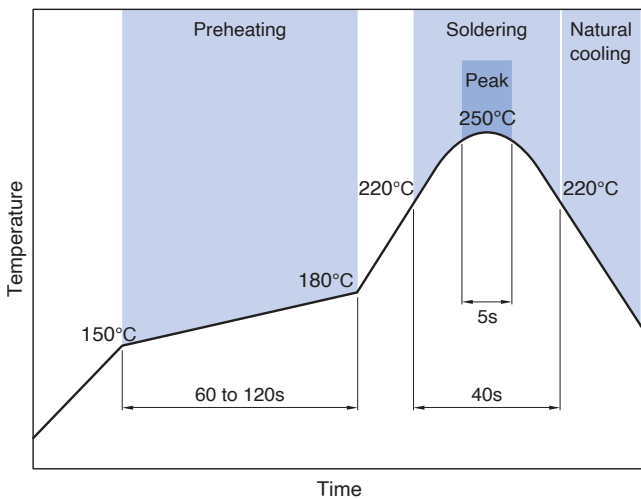

## TEMPERATURE RANGE, INDIVIDUAL WEIGHT

Operating temperature range *	Storage temperature range **	Individual weight
-40 to +105 °C	-40 to +105 °C	0.46 g

\* Operating temperature range includes self-temperature rise.

\*\* The storage temperature range is for after the assembly.

## REMINDERS FOR USING THESE PRODUCTS

Before using these products, be sure to request the delivery specifications.

### SAFETY REMINDERS

Please pay sufficient attention to the warnings for safe designing when using this products

### REMINDERS

- The storage period is within 6 months. Be sure to follow the storage conditions (temperature: 5 to 30°C, humidity: 0 to 75% RH or less). If the storage period elapses, the soldering of the terminal electrodes may deteriorate.
- Do not use or store in locations where there are conditions such as gas corrosion (salt, acid, alkali, etc.).
- Before soldering, be sure to preheat components.  
The preheating temperature should be set so that the temperature difference between the solder temperature and chip temperature does not exceed 150°C.
- Soldering corrections after mounting should be within the range of the conditions determined in the specifications.  
If overheated, a short circuit, performance deterioration, or lifespan shortening may occur.
- When embedding a printed circuit board where a chip is mounted to a set, be sure that residual stress is not given to the chip due to the overall distortion of the printed circuit board and partial distortion such as at screw tightening portions.
- Self heating (temperature increase) occurs when the power is turned ON, so the tolerance should be sufficient for the set thermal design.
- Carefully lay out the coil for the circuit board design of the non-magnetic shield type.  
A malfunction may occur due to magnetic interference.
- Use a wrist band to discharge static electricity in your body through the grounding wire.
- Do not expose the products to magnets or magnetic fields.
- Do not use for a purpose outside of the contents regulated in the delivery specifications.
- The products listed on this catalog are intended for use in general electronic equipment (AV equipment, telecommunications equipment, home appliances, amusement equipment, computer equipment, personal equipment, office equipment, measurement equipment, industrial robots) under a normal operation and use condition.  
The products are not designed or warranted to meet the requirements of the applications listed below, whose performance and/or quality require a more stringent level of safety or reliability, or whose failure, malfunction or trouble could cause serious damage to society, person or property.  
If you intend to use the products in the applications listed below or if you have special requirements exceeding the range or conditions set forth in the each catalog, please contact us.

- |                                                                   |                                                                              |
|-------------------------------------------------------------------|------------------------------------------------------------------------------|
| (1) Aerospace/aviation equipment                                  | (7) Transportation control equipment                                         |
| (2) Transportation equipment (cars, electric trains, ships, etc.) | (8) Public information-processing equipment                                  |
| (3) Medical equipment                                             | (9) Military equipment                                                       |
| (4) Power-generation control equipment                            | (10) Electric heating apparatus, burning equipment                           |
| (5) Atomic energy-related equipment                               | (11) Disaster prevention/crime prevention equipment                          |
| (6) Seabed equipment                                              | (12) Safety equipment                                                        |
|                                                                   | (13) Other applications that are not considered general-purpose applications |

When designing your equipment even for general-purpose applications, you are kindly requested to take into consideration securing protection circuit/device or providing backup circuits in your equipment.