

bq20z90EVM-001 SBS 1.1 Impedance Track™ Technology Enabled Battery Management Solution Evaluation Module

This evaluation module (EVM) is a complete evaluation system for the bq20z90/bq29330/ bq29412 battery management system. The EVM includes one bq20z90/bq29330/bq29412 circuit module, a current sense resistor, two thermistors, and Windows®-based PC software. An EV2300 board for gas gauge interface is required to interface this EVM with the PC and can be purchased separately. The circuit module includes one bq20z90 integrated circuit (IC), one bq29330 IC, one bq29412 IC, and all other onboard components necessary to monitor and predict capacity, perform cell balancing, monitor critical parameters, protect the cells from overcharge, over discharge, short circuit, and overcurrent in 2-, 3- or 4-series cell Li-ion or Li-polymer battery packs. The circuit module connects directly across the cells in a battery. With the EV2300 interface board and software, the user can read the bq20z90 data registers, program the chipset for different pack configurations, log cycling data for further evaluation, and evaluate the overall functionality of the bq20z90/ bq29330/bq29412 solution under different charge and discharge conditions.

Contents

1	Features	2
2	bq20z90/bq29330-Based Circuit Module	2
3	bq20z90/bq29330 Circuit Module Schematic	3
4	Circuit Module Physical Layouts and Bill of Materials	4
5	EVM Hardware and Software Setup	8
6	Troubleshooting Unexpected Dialog Boxes	8
7	Hardware Connection	9
8	Operation	10
9	Calibration Screen	13
10	Pro (Advanced) Screen	15

List of Figures

1	bq20z90EVM-001 Layout (Silk Screen).....	4
2	Top Assembly	4
3	Top Layer	5
4	Bottom Layer	5
5	Bottom Assembly	5
6	Schematic	7
7	bq20z90bq29330 Circuit Module Connection to Cells and System Load/Charger	9
8	SBS Data Screen.....	10
9	Data Flash Screen, 1st Level Safety Class	11
10	Calibration Screen.....	14
11	Pro (Advanced) Screen.....	15

List of Tables

1	Ordering Information.....	2
2	Components and Flash-Memory Settings for Different Precharge Modes	4
3	Bill of Materials	6
4	Performance Specification Summary.....	8

Impedance Track is a trademark of Texas Instruments.
Windows is a registered trademark of Microsoft Corporation.

5	Circuit Module to EV2300 Connections	9
---	--	---

1 Features

- Complete evaluation system for the bq20z90 SBS 1.1-compliant advanced gas gauge with Impedance Track™ Technology, bq29330 analog front end (AFE) and protection IC, and bq29412 independent overvoltage protection IC
- Populated circuit module for quick setup
- PC software and interface board for easy evaluation
- Software that allows data logging for system analysis

1.1 Kit Contents

- bq20z90/bq29330/bq29412 circuit module
- Software CD with the evaluation software
- Set of support documentation

1.2 Ordering Information

Table 1. Ordering Information

EVM PART NUMBER	CHEMISTRY	CONFIGURATION	CAPACITY
bq20z90EVM-001	Li-ion	2, 3, or 4 cell	Any

2 bq20z90/bq29330-Based Circuit Module

The bq20z90/bq29330/bq29412-based circuit module is a complete and compact example solution of a bq20z90 and bq29330 circuit for battery management and protection of Li-ion or Li-polymer packs. The circuit module incorporates a bq20z90 battery monitor IC, bq29330 AFE and protection IC, bq29412 independent overvoltage protection IC, and all other components necessary to accurately predict the capacity of 2-, 3-, or 4-series cells.

2.1 Circuit Module Connections

Contacts on the circuit module provide the following connections:

- Direct connection to the cells: 1N (BAT-), 1P, 2P, 3P, 4P (BAT+)
- To the serial communications port (SMBC, SMBD)
- The system load and charger connect across PACK+ and PACK-
- To the system-present pin (SYS PRES)

2.2 Pin Descriptions

PIN NAME	DESCRIPTION
1N	-ve connection of first (bottom) cell
1P	+ve connection of first (bottom) cell
2P	+ve connection of second cell
3P	+ve connection of third cell
4P	+ve connection of fourth (top) cell
SMBC	Serial communication port clock
SMBD	Serial communication data port
SYS PRES	System present pin (if low, system is present)
PACK-	Pack negative terminal
VSS	Pack negative terminal
PACK+	Pack positive terminal

3 bq20z90/bq29330 Circuit Module Schematic

This section contains information for modifying and choosing a precharge mode for bq20z90/bq29330/bq29412 implementation.

3.1 Schematic

The schematic follows the bill of materials in this user's guide.

3.2 Modifications for Choosing Particular Precharge Mode

In order to charge, the charge FET (CHG-FET) must be turned on to create a current path. When the $V_{(BAT)}$ is 0 V and CHG-FET = ON, the $V_{(PACK)}$ is as low as the battery voltage. In this case, the supply voltage for the device is too low to operate. This function has three possible configurations, and the bq29330 can be easily configured according to the application needs. The three modes are 0-V Charge FET mode, Common FET mode, and Precharge FET mode.

1. 0-V Charge FET mode - Dedicates a precharge current path using an additional FET (ZVCHG-FET) to sustain the PACK+ voltage level.
2. Common FET mode - Does not use a dedicated precharge FET. The charge FET (CHG-FET) is set to ON state as default.
3. Precharge FET mode - Dedicates a precharge current path using an additional open-drain (OD) pin drive FET (PCHG-FET) to sustain the PACK+ voltage level.

To use a particular mode of charging with the EVM, add or remove some elements shown in [Table 2](#), and use the given settings of DF.Configuration, ZVCHG1, 0.

Table 2. Components and Flash-Memory Settings for Different Precharge Modes

MODE	RESISTORS	PRECHG FET	ZVCHG1	ZVCHG0
1 0-V Chg (default)	R18, R23	Q3	0	0
2 Common FET	R20	Q2	0	1
3 Precharge	R19, R23	Q3	1	0

For more details about precharge operation and mode choices, see the bq29330 data sheet at [\(SLUS673\)](#).

3.3 Testing Fuse-Blowing Circuit

To prevent the loss of board functionality during the fuse-blowing test, the actual chemical fuse is not provided in the circuit. FET Q4 drives TP4 low if a fuse-blow condition occurs; so, monitoring TP4 can be used to test this condition. Fuse placement on the application board is shown in the bq20z90 data sheet reference-board schematic.

4 Circuit Module Physical Layouts and Bill of Materials

This section contains the board layout, bill of materials, and assembly drawings for the bq20z90/ bq29330/ bq29412 circuit module.

4.1 Board Layout

This section shows the dimensions, PCB layers ([Figure 1](#) through [Figure 5](#)), and assembly drawing for the bq20z90/bq29330 module.

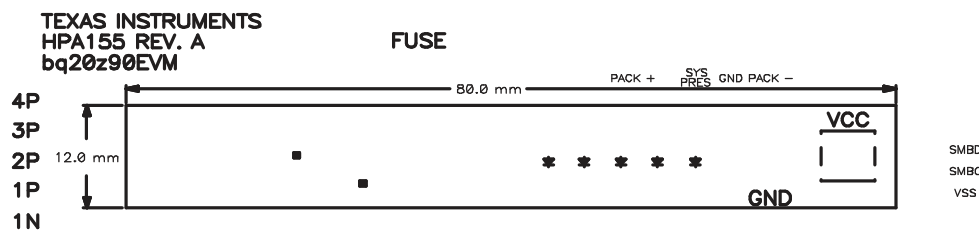
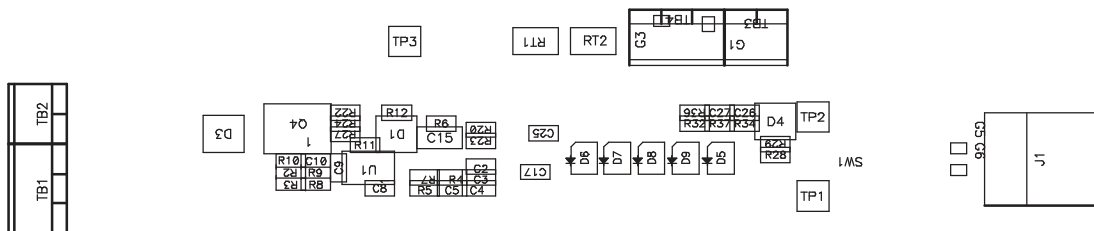
Figure 1. bq20z90EVM-001 Layout (Silk Screen)

Figure 2. Top Assembly

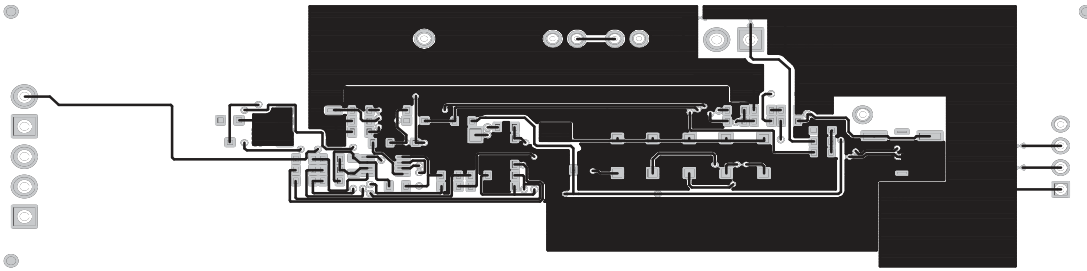

Figure 3. Top Layer

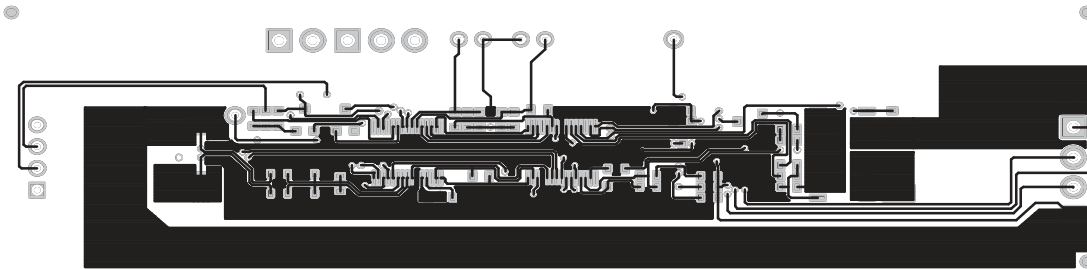

Figure 4. Bottom Layer

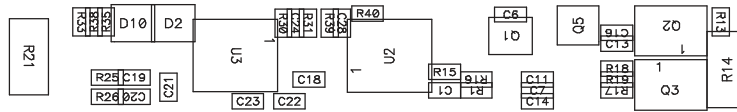
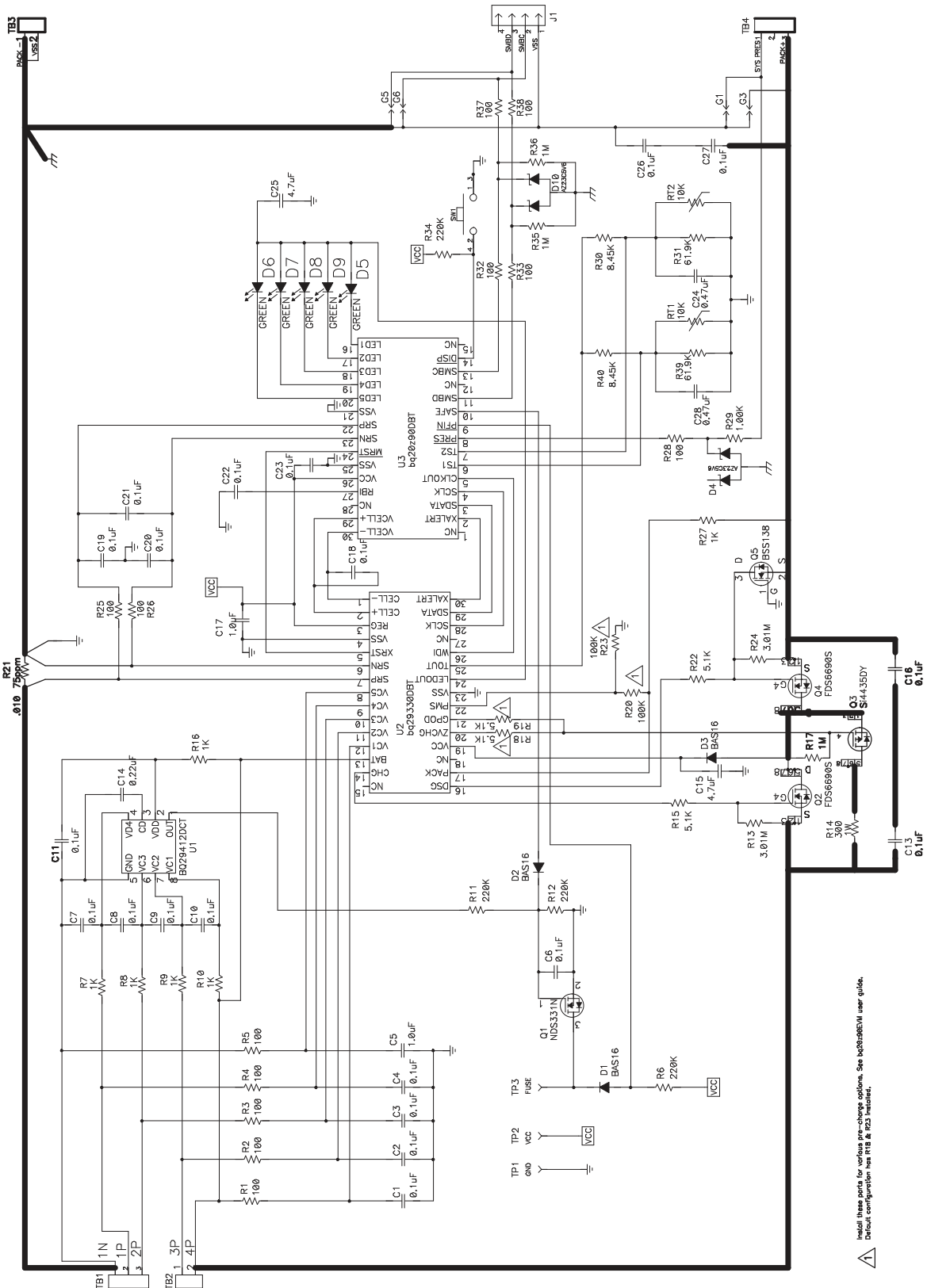

Figure 5. Bottom Assembly

4.2 Bill of Materials and Schematic

Table 3. Bill of Materials

Count	Ref Des	Description	Size	MFG	Part No.
20	C1, C2, C3, C4, C6, C7, C8, C9, C10, C11, C13, C16, C18, C19, C20, C21, C22, C23, C26, C27	Capacitor, ceramic, 0.1 μ F 50 V, X7R, 20%	0603	Any	STD
1	C14	Capacitor, ceramic, 0.22 μ F, 50 V, X7R, 20%	0603	Any	STD
1	C15	Capacitor, ceramic, 4.7 μ F, 25 V, X7R, 10%	1206	Any	STD
2	C24, C28	Capacitor, ceramic, 0.47 μ F, 16 V, X7R, 20%	0603	Any	STD
1	C25	Capacitor, ceramic, 4.7 μ F, 10 V, X7R, 20%	0603	Any	STD
2	C5, C17	Capacitor, ceramic, 1.0 μ F, 50 V, X7R, 20%	0805	Any	STD
3	D1, D2, D3	Diode, switching, 150-mA, 75-V, 350 mW	SOT23	Vishay-Liteon	BAS16
2	D4, D10	Diode, dual, Zener, 5.6 V, 300 mW	SOT23	Vishay-Telefunken	AZ23C5V6
5	D5, D6, D7, D8, D9	Diode, LED, green, Gullwing, GW type, 20 mA, 7.5 mcd Typ	0.120 \times 0.087	Panasonic	LN1361C
1	J1	Header, friction lock assembly, 4-pin right angle	0.400 \times 0.500	Molex	22-05-3041
1	Q1	MOSFET, P-ch, 20 V, 1.3 A, 0.16 Ω	SOT23	Fairchild	NDS331N
2	Q2, Q4	MOSFET, N-ch, 30 V, 10 A, Rds 16 m Ω	SO8	Fairchild	FDS6690S
1	Q3	MOSFET, P-ch, 30 V, 8.0-A, 20-m Ω	SO8	Siliconix	Si4435DY
1	Q5	MOSFET, Nch, 50 V, 0.22 A, 6 Ω	SOT23	Fairchild	BSS138
12	R1, R2, R3, R4, R5, R25, R26, R28, R32, R33, R37, R38	Resistor, chip, 100 Ω , 1/16 W, 5%	0603	STD	STD
2	R13, R24	Resistor, chip, 3.01 m Ω , 1/16 W, 5%	0603	STD	STD
1	R14	Resistor, chip, 300- Ω , 1-W, 10%	2512		WSL=2512-xx
3	R15, R18, R22	Resistor, chip, 5.1 k Ω , 1/16 W, 5%	0603	STD	STD
0	R19	Resistor, chip, 5.1 k Ω , 1/16 W, 5%	0603	STD	STD
3	R17, R35, R36	Resistor, chip, 1 m Ω , 1/16 W, 5%	0603	STD	STD
1	R23	Resistor, chip, 100 k Ω , 1/16 W, 5%	0603	STD	STD
0	R20	Resistor, chip, 100 k Ω , 1/16 W, 5%	0603	STD	STD
1	R21	Resistor, chip, 0.010 Ω , 1-W, xx%	2512	Vishay	WSL-2512-020
1	R29	Resistor, chip, 1 k Ω , 1/16 W, 5%	0603	STD	STD
2	R30, R40	Resistor, chip, 8.45 k Ω , 1/16 W, 1%	0603	STD	STD
2	R31, R39	Resistor, chip, 61.9 k Ω , 1/16 W, 1%	0603	STD	STD
4	R6, R11, R12, R34	Resistor, chip, 220 k Ω , 1.16 W, 5%	0603	STD	STD
6	R7, R8, R9, R10, R16, R27	Resistor, chip, 1 k Ω , 1.16 W, 5%	0603	STD	STD
2	RT1, RT2	Thermistor, 10 k Ω	0.095 \times 0.150	Sematec	NTC103AT
1	SW1	Switch, push button, momentary, N.O. low profile	5 mm \times 5 mm	Panasonic	EVQPLCxxxx
2	TB1, TB4	Terminal block, 3 pin, 6 A, 3.5 mm	0.41 \times 0.25	OST	ED1515
2	TB2, TB3	Terminal block, 2 pin, 6 A, 3.5 mm	0.27 \times 0.25	OST	ED1514
1	TP1	Test point, black, thru hole color keyed	0.100 \times 0.100	Keystone	5001
1	TP2	Test point, red, thru hole color keyed	0.100 \times 0.100	Keystone	5000
1	TP2	Test point, white, thru hole color keyed	0.100 \times 0.100	Keystone	5002
1	U1	IC, voltage protection for 2, 3, or 4 cell Li-Ion, 2nd protection, 4.45 V, OVP	SSOP-08	TI	bq29412DCT
1	U2	IC, 2-3, or 4 cell series protection control AFE	TSSOP30	TI	bq29330DBT
1	U3	IC, impedance track advanced gas gauge	TSSOP30	TI	bq20z90DBT



Install three parts for various pre-charge options. See bq20z90EVM user guide. Default configuration has R18 & R22 installed.

Figure 6. Schematic

4.3 bq20z90/bq29330/bq29412 Circuit Module Performance Specification Summary

This section summarizes the performance specifications of the bq20z90/ bq29330/bq29412 circuit module.

Table 4. Performance Specification Summary

Specification	Min	Typ	Max	Units
Input voltage Pack+ to Pack–	6	15	25	V
Charge and discharge current	0	2	7	A

5 EVM Hardware and Software Setup

This section describes how to install the bq20z90EVM-001 PC software, and how to connect the different components of the EVM.

5.1 System Requirements

The bq20z90EVSW software requires Windows 2000 or Windows XP. Drivers for Windows 98SE are provided, but Microsoft no longer supports Windows 98; and there may be issues in Windows 98 with USB driver support. The EV2300 USB drivers have been tested for Windows 98SE, but no assurance is made for problem-free operation with specific system configurations.

5.2 Software Installation

Find the latest software version in the bq20z90 tool folder on power.ti.com. Use the following steps to install the bq20z90EVSW software:

1. Copy the files from the CD into the temporary directory you selected, open the archive TI USB DRVRS.zip, and extract its contents in a subdirectory/drivers. Choose preserve *directory structure* option when extracting. Alternatively, run SETUP.EXE from the same directory.
2. Plug the EV2300 into a USB port.
3. Wait until system prompt *new hardware found* appears. Choose *select location manually*, and use the *browse* button to point to subdirectory TIUSBWin2K-XP-1.
4. Answer *continue* to the warning that drivers are not certified with Microsoft.
5. After installation finishes, another system prompt *new hardware found* appears. Repeat procedure above, but point to subdirectory TIUSBWin2K-XP-2
6. Answer *continue* to the warning that drivers are not certified with Microsoft. Installation of drivers is now finished.
7. For Windows 98, point to directory TIUSBWin98.
8. Return to the temporary directory where you extracted files; double-click on the *Setup.exe* icon to install EV Software.

If files were downloaded from the Web:

1. Open the archive containing the installation package, and copy its contents in a temporary directory.
2. Follow the preceding steps 1 - 8.

6 Troubleshooting Unexpected Dialog Boxes

Ensure that the files were extracted from the zip file using the *Preserve Folder names* option.

Ensure that all the files were extracted from the zip file.

The user that is downloading the files must be logged in as the administrator.

The driver is not signed, so the administrator must allow installation of unsigned drivers in the operating system policy.

7 Hardware Connection

The bq20z90EVM-001 comprises three hardware components: the bq20z90/bq29330/bq29412 circuit module, the EV2300 PC interface board (purchased separately), and the PC.

7.1 Connecting the bq20z90/bq29330/bq29412 Circuit Module to a Battery Pack

Figure 7 shows how to connect the bq20z90/bq29330/bq29412 circuit module to the cells and system load/charger.

The cells should be connected in the following order:

1. 4-Cell Pack: 1N (BAT-), 1P, and 2P (see Section 2.1 for definitions).
2. 3-Cell Pack: 1N (BAT-), 1P, 2P, and then connect 4P and 3P together.
3. 2-Cell Pack: 1N (BAT-), 1P, and then connect 4P, 3P, and 2P together

To start charge or discharge test, connect PRES pin to PACK- pin to set SYS PRES state. To test sleep mode, disconnect the PRES pin.

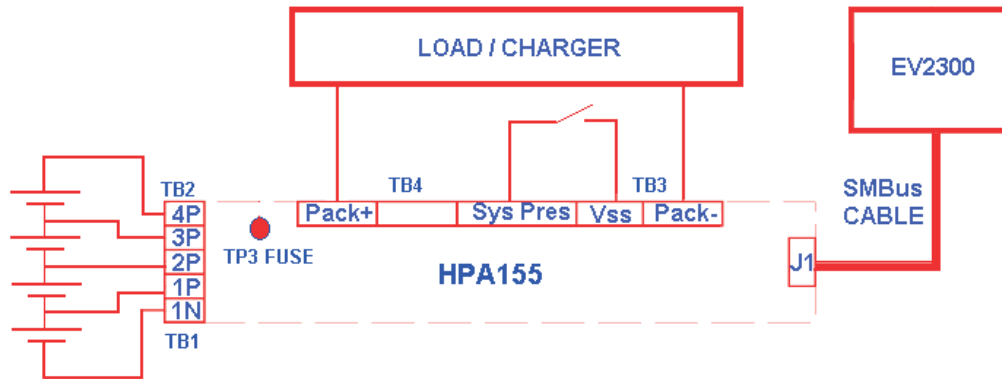

Figure 7. bq20z90/bq29330 Circuit Module Connection to Cells and System Load/Charger

7.2 PC Interface Connection

The following steps configure the hardware for interface to the PC:

1. Connect the bq20z90/bq29330-based smart battery to the EV2300 using wire leads as shown in Table 5.

Table 5. Circuit Module to EV2300 Connections

bq20z90/bq29330-Based Battery	EV2300
SMBD	SMBD
SMBC	SMBC
VSS	GND

2. Connect the PC USB cable to the EV2300 and the PC USB port.

The bq20z90EVM-001 is now set up for operation.

8 Operation

This section details the operation of the bq20z90 EVSW software.

8.1 Starting the Program

Run bq20z90 EVSW from the Start | Programs | Texas Instruments | bq20z90 EVSW menu sequence. The SBS Data screen (Figure 8) appears. Data begins to appear once the <Refresh> (single time scan) button is clicked, or when the <Keep Scanning> check box is checked. To disable the scan feature, deselect <Keep Scanning>.

The continuous scanning period can be set via the | Options | and | Set Scan Interval | menu selections. The range for this interval is 0 ms to 65535 ms. Only items that are selected for scanning are scanned within this period.

The bq20z90 EVSW provides a logging function which logs the values that were last scanned by EVSW. To enable this function, select the *Start Logging* button, this causes the *Keep Scanning* button to be selected. When logging is *Stopped*, the keep scanning button is still selected and has to be manually unchecked.

The logging intervals are specified under the | Options | menu with the maximum value of 65535 ms. The *Log* interval cannot be smaller than scan interval because this results in the same value being logged at least twice.

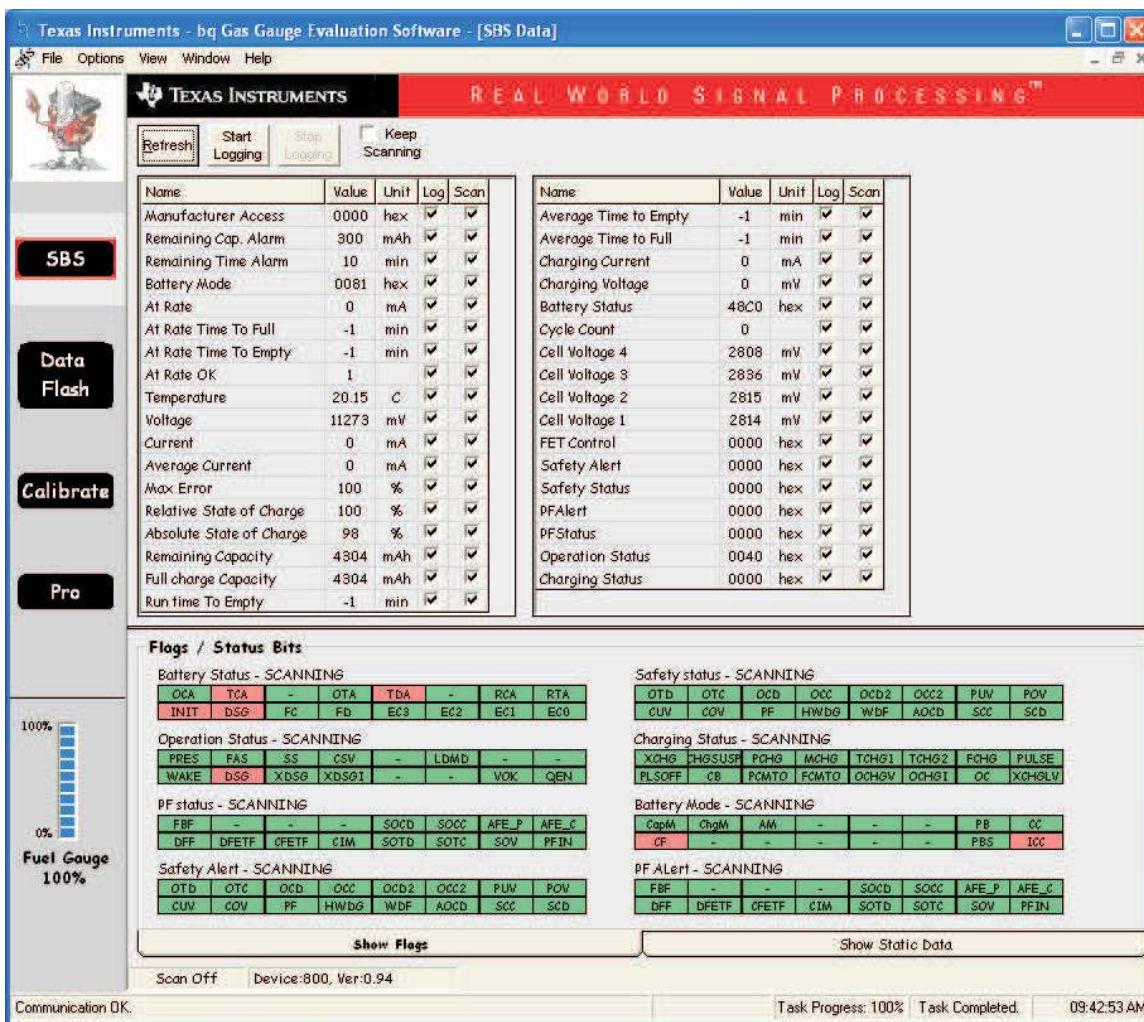

Figure 8. SBS Data Screen

This screen (Figure 8) shows the SBS data set along with additional ManufacturersAccess() command information such as individual cell measurements. Additional Flag and Static data can be viewed by selecting the appropriate tab at the bottom of the SBS screen.

Data such as SBS.ManufacturerName() is static and does not change. This data is viewed separately using the *Static Data* tab available at the bottom of the screen.

Dragging the splitter bar (line that separates the Flags/Static data from SBS values) changes the height of the Flags/Static Data display. Selecting | View |, then | Auto Arrange | returns the splitter bar to its original location.

8.2 Setting Programmable bq20z90 and bq29330 Options

The bq20z90 data flash comes configured per the default settings detailed in the bq20z90 data sheet. Ensure that the settings are correctly changed to match the pack and application for the bq20z90/bq29330 solution being evaluated.

IMPORTANT: The correct setting of these options is essential to get the best performance.

The settings can be configured using the Data Flash screen (Figure 9).

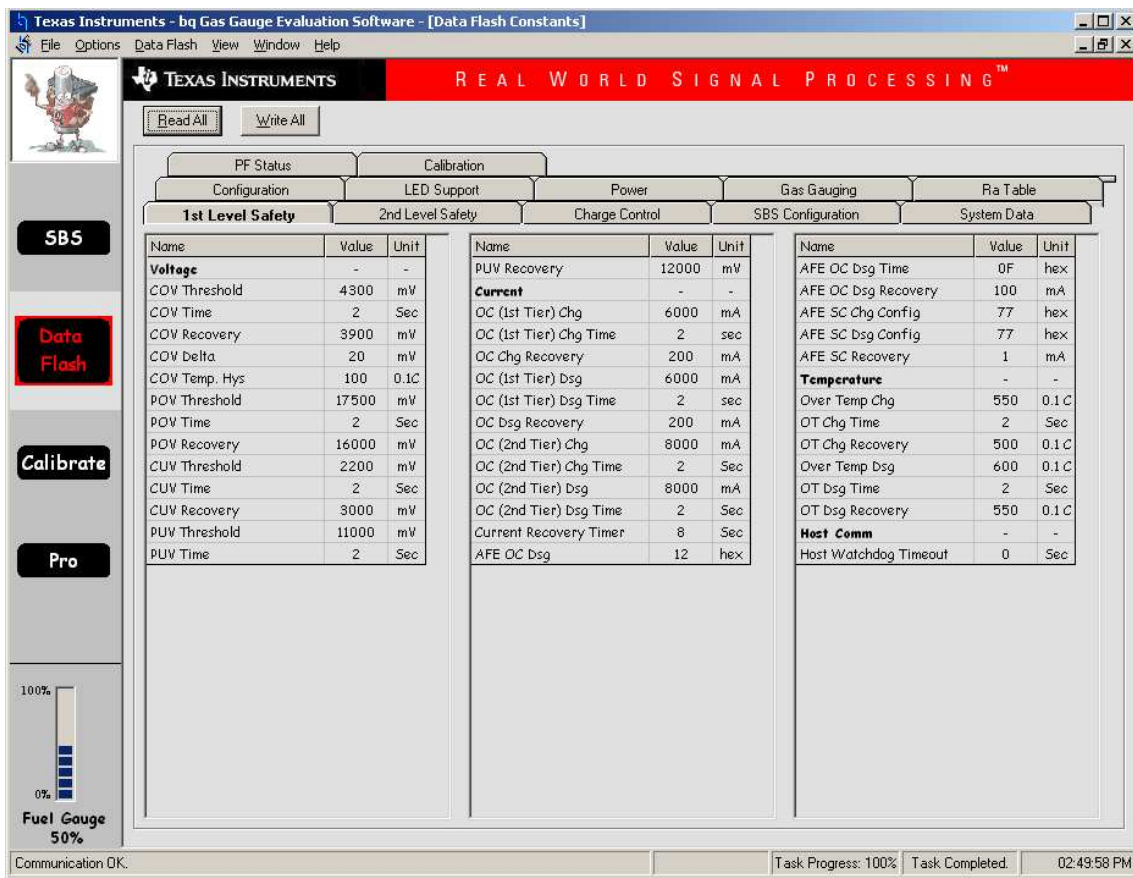

Figure 9. Data Flash Screen, 1st Level Safety Class

To read all the data from the bq20z90 data flash, click on menu option | Data Flash | Read All |.

To write to a data flash location, click on the desired location, enter the data and press <Enter>, which writes the entire tab of flash data, or select menu option | Data Flash | Write All |. The data flash must be read before any writes are performed to avoid any incorrect data being written to the device.

The | File | Special Export | menu options allows the data flash to be exported, but it configures the exported data flash to a learned state ready for mass production use.

The data flash configuration can be saved to a file by selecting | File | Export | and entering a file name. A data flash file can also be retrieved in this way, imported, and written to the bq20z90 using the | Write All | button.

The configuration information of the bq29330 and module calibration data is also held in the bq20z90 data flash.

The bq20z90 allows for an automatic data flash export function, similar to the SBS Data logging function. This feature, when selected via | Options | Auto Export |, exports Data Flash to a sequential series of files named as *FilenameNNNNN.gg* where N = a decimal number from 0 to 9.

The AutoExport interval is set under the | Options menu | with a minimum value of 15 s. The AutoExport filename is also set under the | Options menu |.

When there is a check next to | AutoExport |, the AutoExport is in progress. The same menu selection is used to turn on / off AutoExport.

If the data flash screen is blank, then the bq20z90 that is being used may not be supported by the bqEVSW version that is being used. An upgrade may be required.

9 Calibration Screen

9.1 How to Calibrate

Before the bq20z90 is calibrated:

- Connect a load to Pack- and Pack+ that draws approximately 2 A and measures discharge current to use the FETs.
- Connect a current source to Batt- and Pack- to calibrate without using the FETs.
- Measure the pack voltage from Batt+ to Batt- (Total of Cell voltages).
- Measure the temperature of the pack.
- These steps may or may not be required, depending on the type of calibration being performed.

Note that voltage calibration with cells attached requires special consideration. Cells must be in a resting state. For additional information, go to the TI Web site (www.ti.com) and access the TI Knowledge Base and search for *bq20zxx Calibration Using EV Software*.

9.2 To Calibrate the bq20z90

Select the types of calibration to be performed (see [Figure 10](#)).

Enter the measured values for the types selected.

If *Voltage Calibration* is selected, then enter the number of cells on the pack.

If *Temperature Calibration* is selected, then select the sensor that is to be calibrated.

If the load is connected between Pack+ and Pack-, then select the *Use FETs* check box.

Press the *Calibrate Part* button.

9.3 Board Offset Calibration

This performs the offset calibration for the current offset of the board.

Remove load/external voltage and short Pack- to Batt-.

Press the *CC Board Offset Calibration* button.

9.4 Pack Voltage Calibration

This calibrates the voltage at the AFE Pack pin.

Make sure *Voltage Calibration* has been performed for the pack. If *Voltage Calibration* is not performed, then *Pack Voltage Calibration* calibrates incorrectly.

Remove load/external voltage applied between Pack+ and Pack-.

Press the *Pack Voltage* button to calibrate.

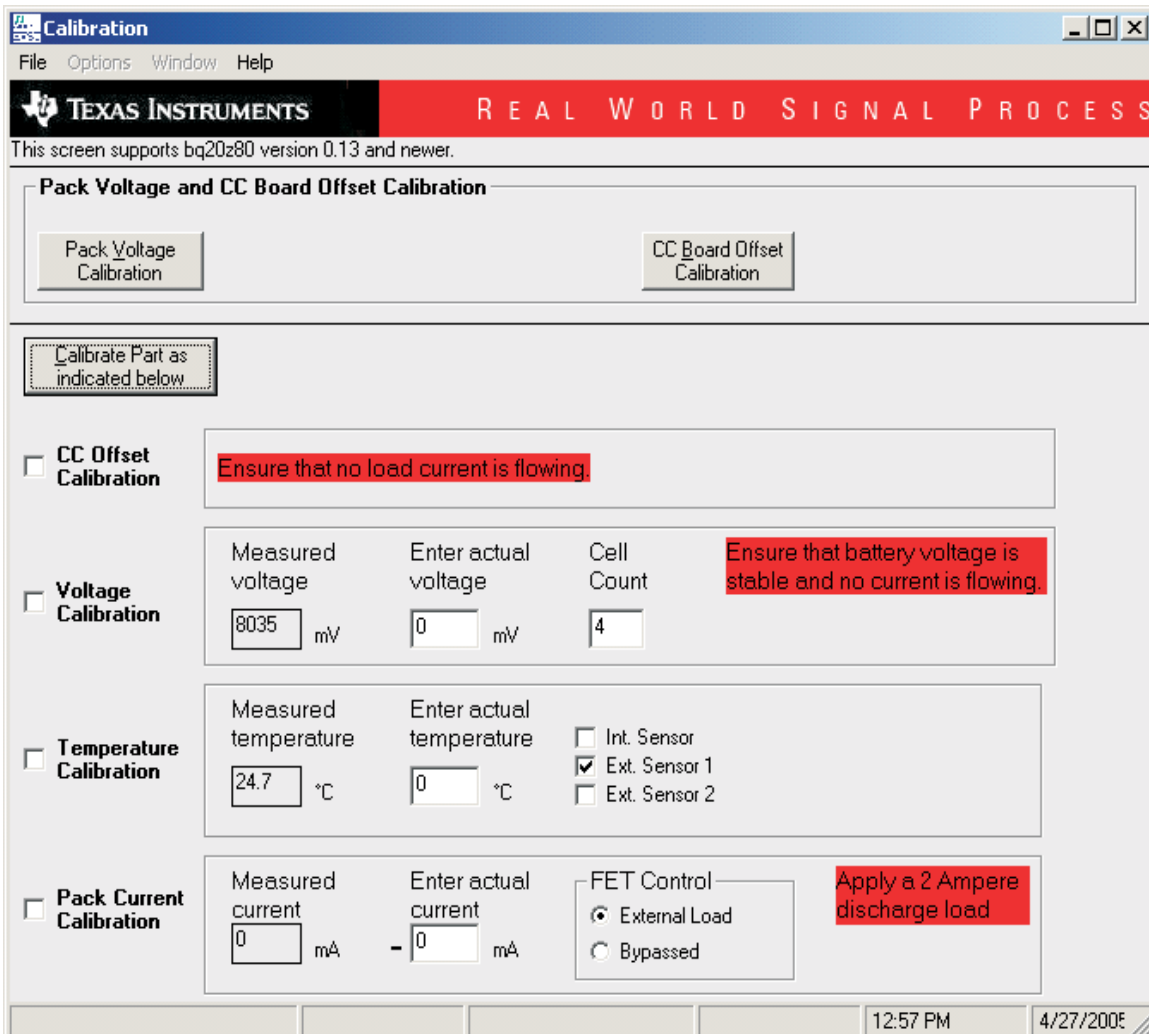

Figure 10. Calibration Screen

10 Pro (Advanced) Screen

10.1 SMB Communication

The set of read/write operations over SMBus are not specific to any gas gauge. These are provided as general-purpose communication tools (Figure 11).

10.2 Hexadecimal/Decimal Converter

These two boxes convert between hexadecimal and decimal as soon as values are typed into the boxes. Invalid values may cause erroneous results.

When scaling converted hexadecimal values to a higher number of bytes, follow these rules:

- When unsigned is selected, the left pad contains zeroes.
- When signed is selected, the left pad contains zeroes for a positive number, or the left pad contains *F* for negative numbers.

10.3 Programming

This screen allows device reprogramming from unencrypted and encrypted files.

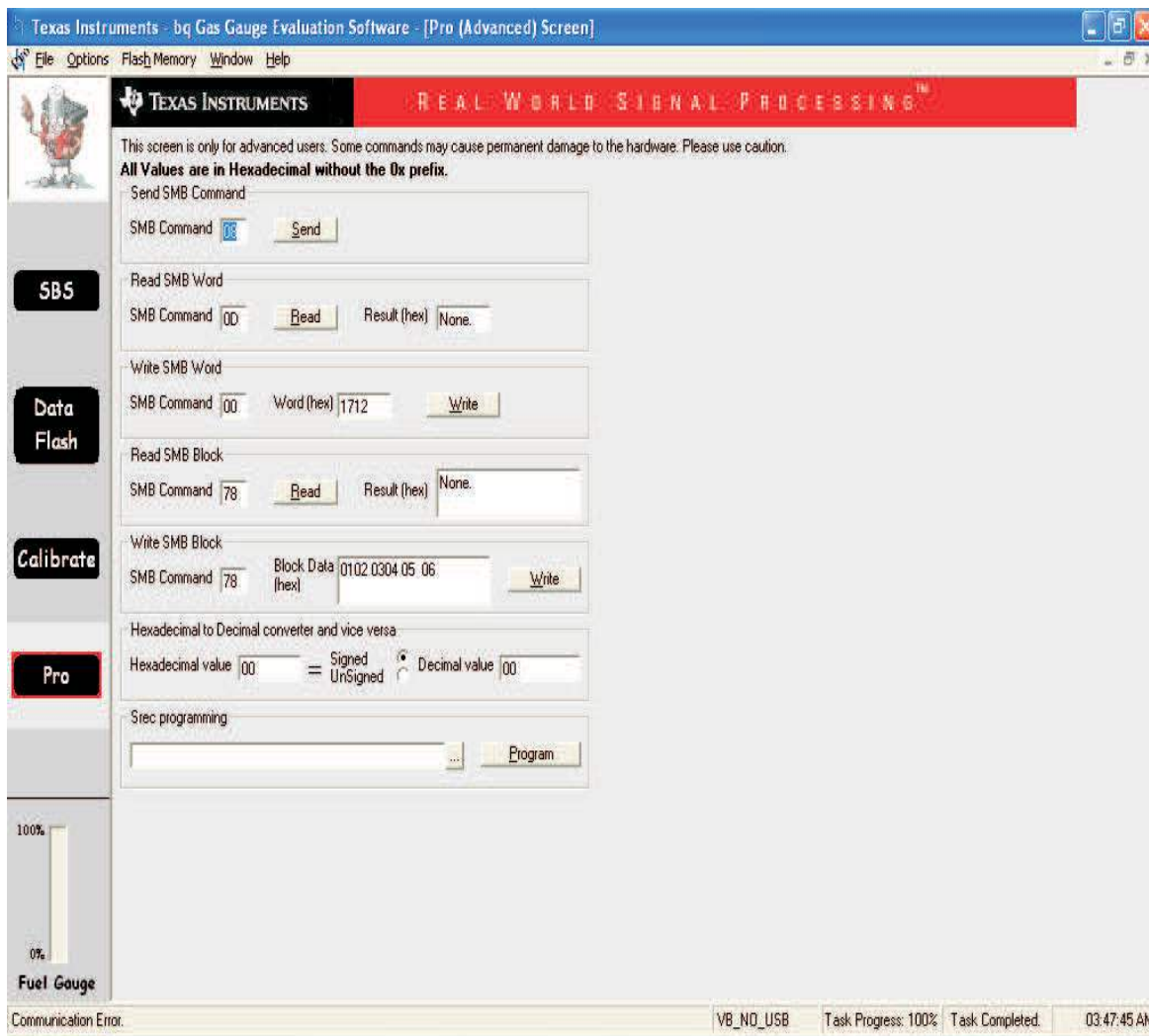

Figure 11. Pro (Advanced) Screen

Related Documentation from Texas Instruments

To obtain a copy of any of the following TI document, call the Texas Instruments Literature Response Center at (800) 477-8924 or the Product Information Center (PIC) at (972) 644-5580. When ordering, identify this document by its title and literature number. Updated documents can also be obtained through the TI Web site at www.ti.com.

Data Sheets:

bq20z90

bq29330

Literature Number:[SLUS662](#)[SLUS673](#)

IMPORTANT NOTICE

Texas Instruments Incorporated and its subsidiaries (TI) reserve the right to make corrections, enhancements, improvements and other changes to its semiconductor products and services per JESD46, latest issue, and to discontinue any product or service per JESD48, latest issue. Buyers should obtain the latest relevant information before placing orders and should verify that such information is current and complete. All semiconductor products (also referred to herein as "components") are sold subject to TI's terms and conditions of sale supplied at the time of order acknowledgment.

TI warrants performance of its components to the specifications applicable at the time of sale, in accordance with the warranty in TI's terms and conditions of sale of semiconductor products. Testing and other quality control techniques are used to the extent TI deems necessary to support this warranty. Except where mandated by applicable law, testing of all parameters of each component is not necessarily performed.

TI assumes no liability for applications assistance or the design of Buyers' products. Buyers are responsible for their products and applications using TI components. To minimize the risks associated with Buyers' products and applications, Buyers should provide adequate design and operating safeguards.

TI does not warrant or represent that any license, either express or implied, is granted under any patent right, copyright, mask work right, or other intellectual property right relating to any combination, machine, or process in which TI components or services are used. Information published by TI regarding third-party products or services does not constitute a license to use such products or services or a warranty or endorsement thereof. Use of such information may require a license from a third party under the patents or other intellectual property of the third party, or a license from TI under the patents or other intellectual property of TI.

Reproduction of significant portions of TI information in TI data books or data sheets is permissible only if reproduction is without alteration and is accompanied by all associated warranties, conditions, limitations, and notices. TI is not responsible or liable for such altered documentation. Information of third parties may be subject to additional restrictions.

Resale of TI components or services with statements different from or beyond the parameters stated by TI for that component or service voids all express and any implied warranties for the associated TI component or service and is an unfair and deceptive business practice. TI is not responsible or liable for any such statements.

Buyer acknowledges and agrees that it is solely responsible for compliance with all legal, regulatory and safety-related requirements concerning its products, and any use of TI components in its applications, notwithstanding any applications-related information or support that may be provided by TI. Buyer represents and agrees that it has all the necessary expertise to create and implement safeguards which anticipate dangerous consequences of failures, monitor failures and their consequences, lessen the likelihood of failures that might cause harm and take appropriate remedial actions. Buyer will fully indemnify TI and its representatives against any damages arising out of the use of any TI components in safety-critical applications.

In some cases, TI components may be promoted specifically to facilitate safety-related applications. With such components, TI's goal is to help enable customers to design and create their own end-product solutions that meet applicable functional safety standards and requirements. Nonetheless, such components are subject to these terms.

No TI components are authorized for use in FDA Class III (or similar life-critical medical equipment) unless authorized officers of the parties have executed a special agreement specifically governing such use.

Only those TI components which TI has specifically designated as military grade or "enhanced plastic" are designed and intended for use in military/aerospace applications or environments. Buyer acknowledges and agrees that any military or aerospace use of TI components which have **not** been so designated is solely at the Buyer's risk, and that Buyer is solely responsible for compliance with all legal and regulatory requirements in connection with such use.

TI has specifically designated certain components as meeting ISO/TS16949 requirements, mainly for automotive use. In any case of use of non-designated products, TI will not be responsible for any failure to meet ISO/TS16949.

Products

Audio	www.ti.com/audio
Amplifiers	amplifier.ti.com
Data Converters	dataconverter.ti.com
DLP® Products	www.dlp.com
DSP	dsp.ti.com
Clocks and Timers	www.ti.com/clocks
Interface	interface.ti.com
Logic	logic.ti.com
Power Mgmt	power.ti.com
Microcontrollers	microcontroller.ti.com
RFID	www.ti-rfid.com
OMAP Applications Processors	www.ti.com/omap
Wireless Connectivity	www.ti.com/wirelessconnectivity

Applications

Automotive and Transportation	www.ti.com/automotive
Communications and Telecom	www.ti.com/communications
Computers and Peripherals	www.ti.com/computers
Consumer Electronics	www.ti.com/consumer-apps
Energy and Lighting	www.ti.com/energy
Industrial	www.ti.com/industrial
Medical	www.ti.com/medical
Security	www.ti.com/security
Space, Avionics and Defense	www.ti.com/space-avionics-defense
Video and Imaging	www.ti.com/video

TI E2E Community

e2e.ti.com