

HEXFET® Power MOSFET

- Dynamic dv/dt Rating
- Repetitive Avalanche Rated
- Isolated Central Mounting Hole
- Fast Switching
- Ease of Paralleling
- Simple Drive Requirements

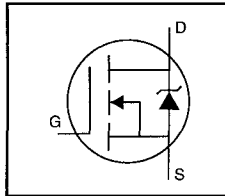

$$V_{DSS} = 450V$$

$$R_{DS(on)} = 0.35\Omega$$

$$I_D = 14A$$

Description

Third Generation HEXFETs from International Rectifier provide the designer with the best combination of fast switching, ruggedized device design, low on-resistance and cost-effectiveness.

The TO-247 package is preferred for commercial–industrial applications where higher power levels preclude the use of TO-220 devices. The TO-247 is similar but superior to the earlier TO-218 package because of its isolated mounting hole. It also provides greater creepage distance between pins to meet the requirements of most safety specifications.

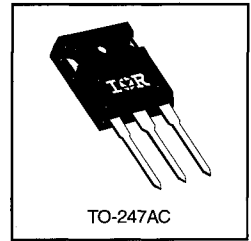

Absolute Maximum Ratings

	Parameter	Max.	Units
$I_D @ T_C = 25^\circ C$	Continuous Drain Current, $V_{GS} @ 10 V$	14	A
$I_D @ T_C = 100^\circ C$	Continuous Drain Current, $V_{GS} @ 10 V$	9.1	
I_{DM}	Pulsed Drain Current ①	56	
$P_D @ T_C = 25^\circ C$	Power Dissipation	190	W
	Linear Derating Factor	1.5	W/°C
V_{GS}	Gate-to-Source Voltage	± 20	V
E_{AS}	Single Pulse Avalanche Energy ②	740	mJ
I_{AR}	Avalanche Current ①	14	A
E_{AR}	Repetitive Avalanche Energy ①	19	mJ
dv/dt	Peak Diode Recovery dv/dt ③	3.5	V/ns
T_J	Operating Junction and	-55 to +150	°C
T_{STG}	Storage Temperature Range		
	Soldering Temperature, for 10 seconds	300 (1.6mm from case)	
	Mounting Torque, 6-32 or M3 screw	10 lbf•in (1.1 N•m)	

Thermal Resistance

	Parameter	Min.	Typ.	Max.	Units
$R_{\theta JC}$	Junction-to-Case	—	—	0.65	°C/W
$R_{\theta CS}$	Case-to-Sink, Flat, Greased Surface	—	0.24	—	
$R_{\theta JA}$	Junction-to-Ambient	—	—	40	

Electrical Characteristics @ $T_J = 25^\circ\text{C}$ (unless otherwise specified)

	Parameter	Min.	Typ.	Max.	Units	Test Conditions
$V_{(BR)DSS}$	Drain-to-Source Breakdown Voltage	450	—	—	V	$V_{GS}=0V, I_D=250\mu A$
$\Delta V_{(BR)DSS}/\Delta T_J$	Breakdown Voltage Temp. Coefficient	—	0.61	—	V/ $^\circ\text{C}$	Reference to 25°C , $I_D=1\text{mA}$
$R_{DS(on)}$	Static Drain-to-Source On-Resistance	—	—	0.35	Ω	$V_{GS}=10V, I_D=8.4A$ ④
$V_{GS(th)}$	Gate Threshold Voltage	2.0	—	4.0	V	$V_{DS}=V_{GS}, I_D=250\mu A$
g_{fs}	Forward Transconductance	5.9	—	—	S	$V_{DS}=50V, I_D=8.4A$ ④
I_{DSS}	Drain-to-Source Leakage Current	—	—	25	μA	$V_{DS}=450V, V_{GS}=0V$
		—	—	250		$V_{DS}=360V, V_{GS}=0V, T_J=125^\circ\text{C}$
I_{GSS}	Gate-to-Source Forward Leakage	—	—	100	nA	$V_{GS}=20V$
	Gate-to-Source Reverse Leakage	—	—	-100		$V_{GS}=-20V$
Q_g	Total Gate Charge	—	—	160	nC	$I_D=14A$
Q_{gs}	Gate-to-Source Charge	—	—	21		$V_{DS}=360V$
Q_{gd}	Gate-to-Drain ("Miller") Charge	—	—	83		$V_{GS}=10V$ See Fig. 6 and 13 ④
$t_{d(on)}$	Turn-On Delay Time	—	14	—		$V_{DD}=225V$
t_r	Rise Time	—	44	—	ns	$I_D=14A$
$t_{d(off)}$	Turn-Off Delay Time	—	89	—		$R_G=6.2\Omega$
t_f	Fall Time	—	46	—		$R_D=16\Omega$ See Figure 10 ④
L_D	Internal Drain Inductance	—	5.0	—	nH	Between lead, 6 mm (0.25in.) from package and center of die contact 
L_S	Internal Source Inductance	—	13	—		
C_{iss}	Input Capacitance	—	2700	—	pF	$V_{GS}=0V$
C_{oss}	Output Capacitance	—	720	—		$V_{DS}=25V$
C_{rss}	Reverse Transfer Capacitance	—	300	—		$f=1.0\text{MHz}$ See Figure 5

Source-Drain Ratings and Characteristics

	Parameter	Min.	Typ.	Max.	Units	Test Conditions
I_S	Continuous Source Current (Body Diode)	—	—	14	A	MOSFET symbol showing the integral reverse p-n junction diode. 
I_{SM}	Pulsed Source Current (Body Diode) ①	—	—	56		
V_{SD}	Diode Forward Voltage	—	—	1.5	V	$T_J=25^\circ\text{C}, I_S=14A, V_{GS}=0V$ ④
t_{rr}	Reverse Recovery Time	—	580	870	ns	$T_J=25^\circ\text{C}, I_F=14A$
Q_{rr}	Reverse Recovery Charge	—	5.1	7.6	μC	$di/dt=100A/\mu s$ ④
t_{on}	Forward Turn-On Time	Intrinsic turn-on time is negligible (turn-on is dominated by L_S+L_D)				

Notes:

- ① Repetitive rating; pulse width limited by max. junction temperature (See Figure 11)
- ② $V_{DD}=50V$, starting $T_J=25^\circ\text{C}$, $L=6.7\text{mH}$, $R_G=25\Omega$, $I_{AS}=14A$ (See Figure 12)
- ③ $I_{SD}\leq 14A$, $di/dt\leq 125A/\mu s$, $V_{DD}\leq V_{(BR)DSS}$, $T_J\leq 150^\circ\text{C}$
- ④ Pulse width $\leq 300\mu s$; duty cycle $\leq 2\%$.

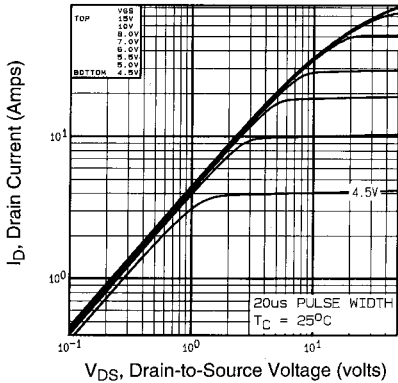

Fig 1. Typical Output Characteristics,
 $T_C=25^\circ\text{C}$

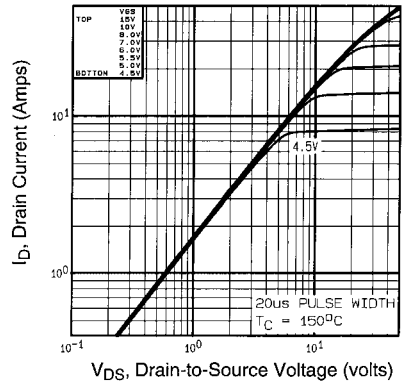

Fig 2. Typical Output Characteristics,
 $T_C=150^\circ\text{C}$

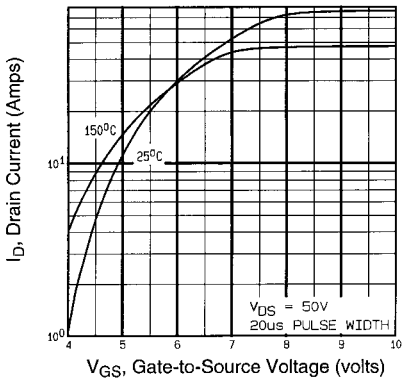

Fig 3. Typical Transfer Characteristics

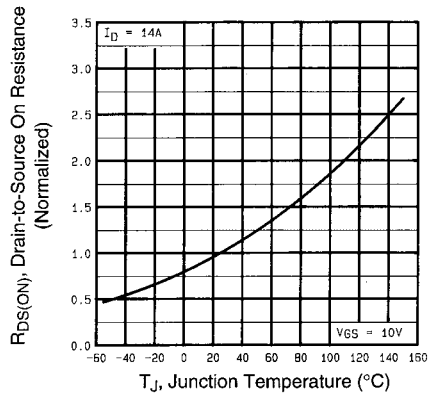

Fig 4. Normalized On-Resistance
Vs. Temperature

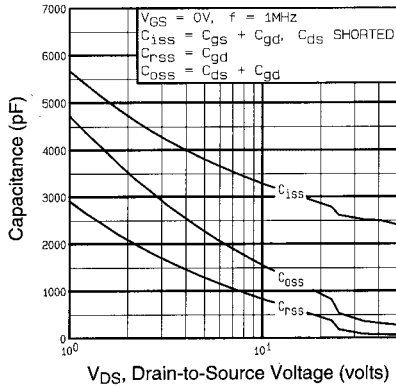

Fig 5. Typical Capacitance Vs. Drain-to-Source Voltage

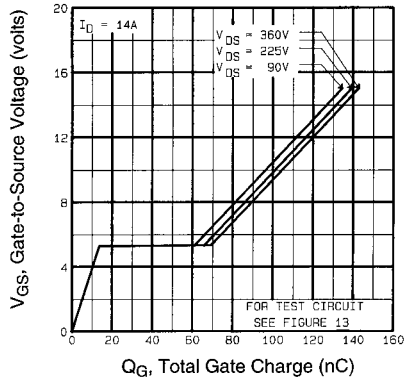

Fig 6. Typical Gate Charge Vs. Gate-to-Source Voltage

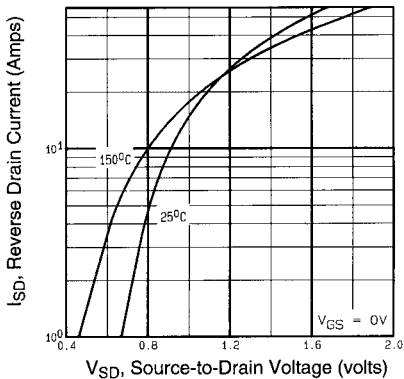

Fig 7. Typical Source-Drain Diode Forward Voltage

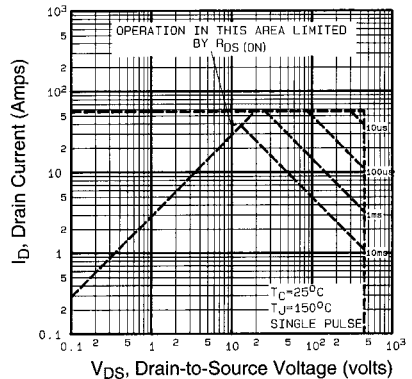

Fig 8. Maximum Safe Operating Area

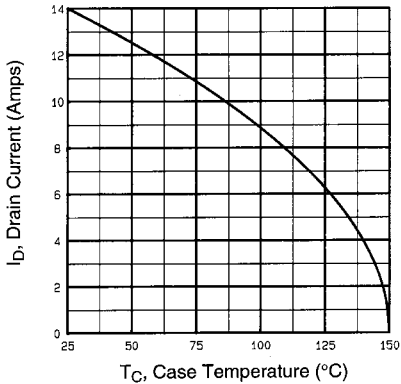

Fig 9. Maximum Drain Current Vs. Case Temperature

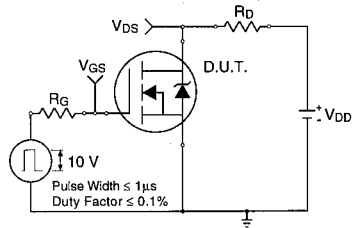

Fig 10a. Switching Time Test Circuit

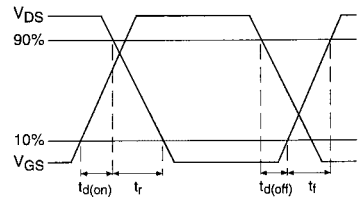

Fig 10b. Switching Time Waveforms

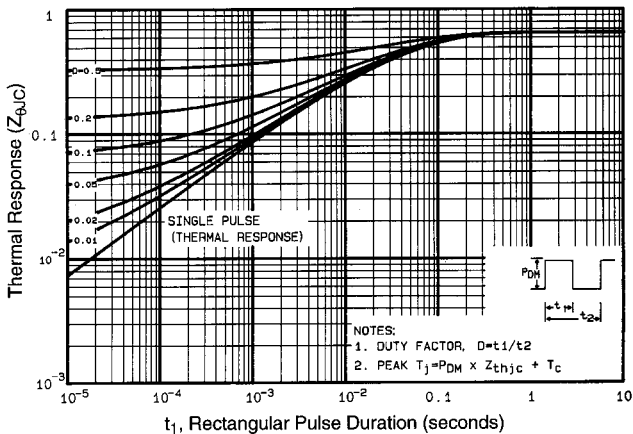

Fig 11. Maximum Effective Transient Thermal Impedance, Junction-to-Case

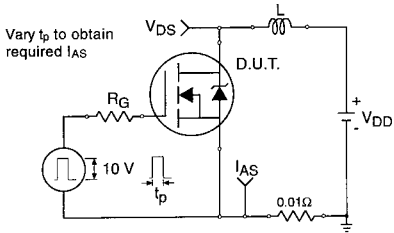

Fig 12a. Unclamped Inductive Test Circuit

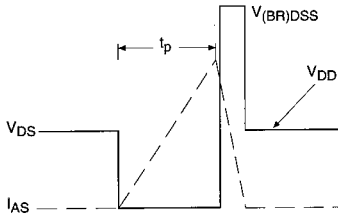

Fig 12b. Unclamped Inductive Waveforms

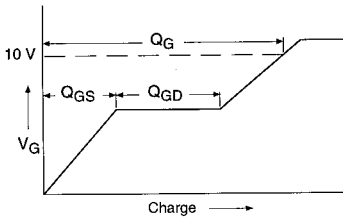

Fig 13a. Basic Gate Charge Waveform

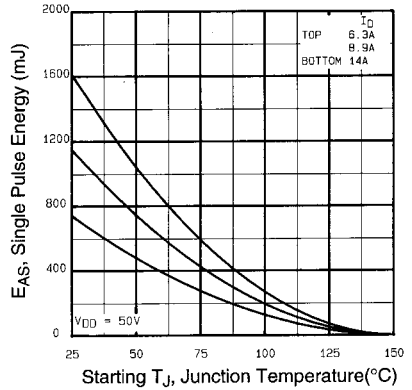

Fig 12c. Maximum Avalanche Energy Vs. Drain Current

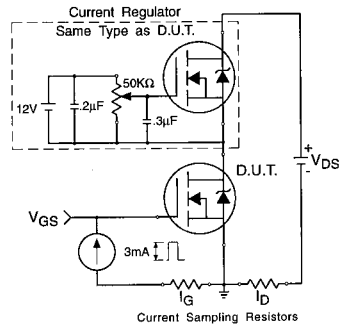
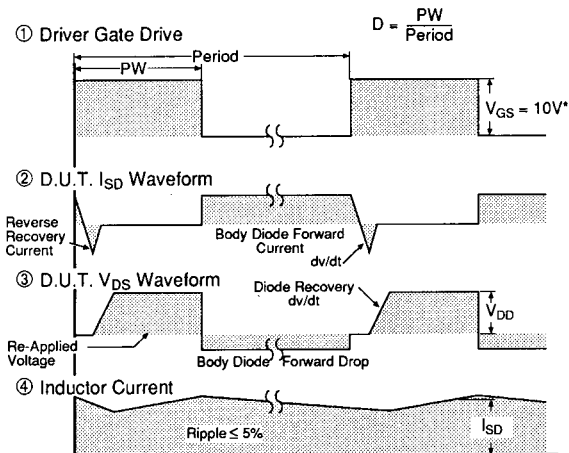
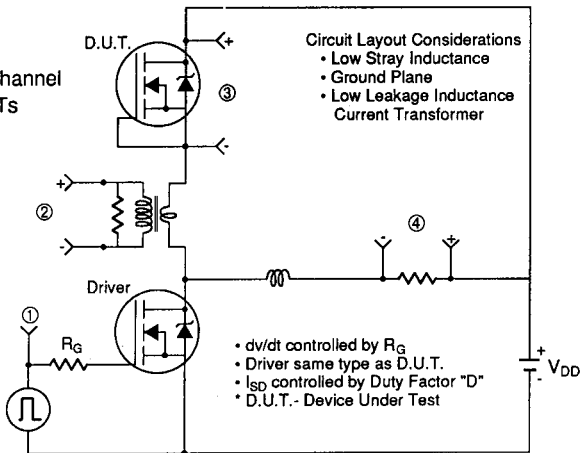

Fig 13b. Gate Charge Test Circuit

Appendix A

Peak Diode Recovery dv/dt Test Circuit

Fig 14. For N-Channel HEXFETs



* $V_{GS} = 5V$ for Logic Level Devices

Package Outline

Appendix B

TO-247AC Outline

Dimensions are shown in millimeters (inches)

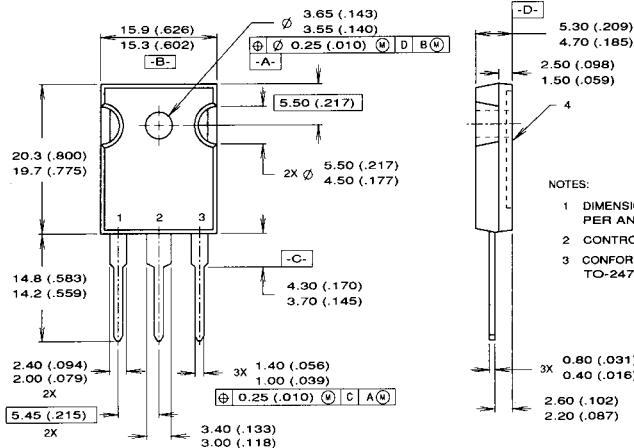

Part Marking Information

Appendix C

TO-247AC

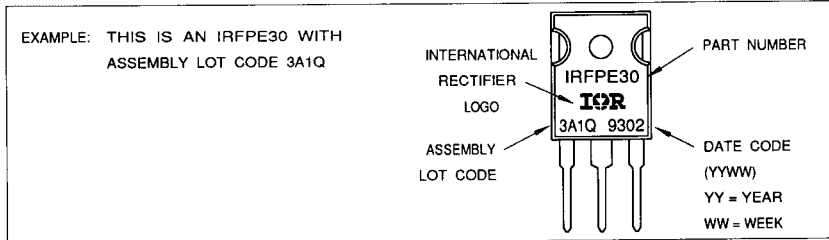

Printed on Signet recycled offset:
made from 50% recycled waste paper, including
10% de-inked, post-consumer waste.



International Rectifier

WORLD HEADQUARTERS: 233 Kansas St., El Segundo, California 90245, Tel: (310) 322-3331, Tlx: 4720403
EUROPEAN HEADQUARTERS: Hurst Green, Oxted, Surrey RH8 9BB England, Tel: (0883) 713215, Tlx: 95219

IR CANADA: 101 Bentley St., Markham, Ontario L3R 3L1, Tel: (416) 475-1897. IR GERMANY: Saalburgstrasse 157, D-6390 Bad Homburg, Tel: 6172-37086. IR ITALY: Via Liguria 49 10071 Borgaro, Torino, Tel: (011) 470 1484. IR FAR EAST: K&H Building, 30-4 Nishiikebukuro 3-Chome, Toshima-ku, Tokyo 171 Japan, Tel: (03) 983 0841. IR SOUTHEAST ASIA: 190 Middle Road, HEX 10-01 Fortune Centre, Singapore 0718, Tel: (65) 336 3922.

Sales Offices, Agents and Distributors in Major Cities Throughout the World.