

T-79-06-20



HA-5102/04/12/14

Low Noise High Performance Operational Amplifiers

August 1991

Features

- Low Noise 4.3nV/√Hz
- Wide Bandwidth 8MHz (Compensated)
60MHz (Uncompensated)
- High Slew Rate 3V/μs (Compensated)
20V/μs (Uncompensated)
- Low Offset Voltage 0.5mV
- Available in Duals or Quads

Applications

- High Q, Active Filters
- Audio Amplifiers
- Instrumentation Amplifiers
- Integrators
- Signal Generators
- For Further Design Ideas, See App. Note 554.

Description

Low noise and high performance are key words describing HA-5102/04/12/14. These general purpose amplifiers offer an array of dynamic specifications ranging from a 3V/μs slew rate and 8MHz bandwidth (5102/04) to 20V/μs slew rate and 60MHz gain-bandwidth-product (HA-5112/14). Complementing these outstanding parameters is a very low noise specification of 4.3nV/√Hz at 1kHz.

Fabricated using the Harris high frequency DI process, these operational amplifiers also offer excellent input specifications such as a 0.5mV offset voltage and 30nA offset current. Complementing these specifications are 108dB open loop gain and 108dB channel separation. Consuming a very modest amount of power (90mW/package for duals and 150mW/package for quads), HA-5102/04/12/14 also provide 15mA of output current.

This impressive combination of features make this series of amplifiers ideally suited for designs ranging from audio amplifiers and active filters to the most demanding signal conditioning and instrumentation circuits.

These operational amplifiers are available in dual or quad form with industry standard pinouts allowing for immediate inter-changeability with most other dual and quad operational amplifiers.

HA-5102 Dual, Comp. HA-5104 Quad, Comp.
HA-5112 Dual, Uncomp. HA-5114 Quad, Uncomp.

Each of these products are available in -2 (-55°C to +125°C), -5 (0°C to +75°C), -9 (-40°C to +85°C) or /883 grades. Refer to the /883 data sheet for military product.

Pinouts

HA3-5102/5112 (PLASTIC MINI-DIP)
HA7-5102/5112 (CERAMIC MINI-DIP)
TOP VIEW

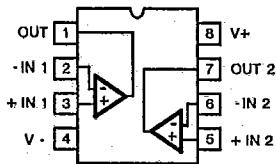

HA2-5102/5112 (TO-99 METAL CAN)
TOP VIEW

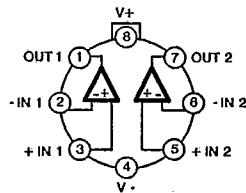

HA1-5104/5114 (CERAMIC DIP)
HA3-5104/5114 (PLASTIC DIP)
TOP VIEW

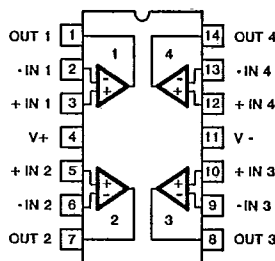

HA9P5102/5112 (SOIC)
TOP VIEW

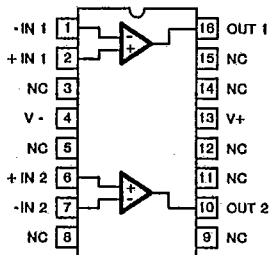

HA9P5104/5114 (SOIC)
TOP VIEW

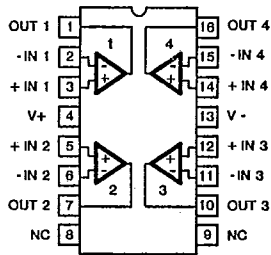

CAUTION: These devices are sensitive to electrostatic discharge. Proper I.C. handling procedures should be followed.
Copyright © Harris Corporation 1991.

File Number 2925

3
OPERATIONAL
AMPLIFIERS

Specifications HA-5102/04/12/14

T-79-06-20

Absolute Maximum Ratings (Note 1)

$T_A = +25^\circ\text{C}$ Unless Otherwise Stated
 Voltage Between V+ and V- Terminals 40.0V
 Differential Input Voltage $\pm 7\text{V}$
 Input Voltage (Note 2) $\pm 15.0\text{V}$
 Output Short Circuit Duration (Note 3) Indefinite
 Power Dissipation (Note 4) 880mW

Operating Temperature Ranges

HA-5102/5104/5112/5114-2 $-55^\circ\text{C} \leq T_A \leq +125^\circ\text{C}$
 HA-5102/5104/5112/5114-5 $-0^\circ\text{C} \leq T_A \leq +75^\circ\text{C}$
 HA-5102/5104/5112/5114-9 $-40^\circ\text{C} \leq T_A \leq +85^\circ\text{C}$
 Storage Temperature Range $-65^\circ\text{C} \leq T_A \leq +150^\circ\text{C}$

Electrical Specifications V+ = 15V D.C., V- = -15V D.C., Unless Otherwise Specified

PARAMETER	TEMP	HA-5102-2, -5 HA-5112-2, -5			HA-5104-2, -5 HA-5114-2, -5			HA-5102-9 HA-5112-9			HA-5104-9 HA-5114-9			UNITS
		MIN	TYP	MAX	MIN	TYP	MAX	MIN	TYP	MAX	MIN	TYP	MAX	
INPUT CHARACTERISTICS														
Offset Voltage	+25°C	-	0.5	2.0	-	0.5	2.5	-	0.5	2.0	-	0.5	2.5	mV
	Full	-	-	2.5	-	-	3.0	-	-	2.5	-	-	3.0	mV
Offset Voltage Average Drift	Full	-	3	-	-	3	-	-	3	-	-	3	-	$\mu\text{V}/^\circ\text{C}$
Bias Current	+25°C	-	130	200	-	130	200	-	130	200	-	130	200	nA
	Full	-	-	325	-	-	325	-	-	500	-	-	500	nA
Offset Current	+25°C	-	30	75	-	30	75	-	30	75	-	30	75	nA
	Full	-	-	125	-	-	125	-	-	125	-	-	125	nA
Input Resistance	+25°C	-	500	-	-	500	-	-	500	-	-	500	-	k Ω
Common Mode Range	Full	± 12	-	-	± 12	-	-	± 12	-	-	± 12	-	-	V
TRANSFER CHARACTERISTICS														
Large Signal Voltage Gain (Note 5)	+25°C	100	250	-	100	250	-	80	250	-	80	250	-	kV/V
	Full	100	-	-	100	-	-	80	-	-	80	-	-	kV/V
Common Mode Rejection Ratio (Note 6)	Full	86	95	-	86	95	-	80	95	-	80	95	-	dB
Small Signal Bandwidth HA-5102/5104 ($A_V = 1$)	+25°C	-	8	-	-	8	-	-	8	-	-	8	-	MHz
Gain Bandwidth Product HA-5112/5114 ($A_V = 10$)	+25°C	-	80	-	-	60	-	-	60	-	-	60	-	MHz
Channel Separation (Note 7)	+25°C	-	108	-	-	108	-	-	108	-	-	108	-	dB
OUTPUT CHARACTERISTICS														
Output Voltage Swing ($R_L = 10\text{K}$) ($R_L = 2\text{K}$)	Full	± 12	± 13	-	± 12	± 13	-	± 12	± 13	-	± 12	± 13	-	V
	Full	± 10	± 12	-	± 10	± 12	-	± 10	± 12	-	± 10	± 12	-	V
Output Current (Note 8)	Full	± 10	± 15	-	± 10	± 15	-	± 7	± 15	-	± 7	± 15	-	mA
Full Power Bandwidth (Note 9) HA-5102/5104 HA-5112/5114	+25°C	16	47	-	16	47	-	16	47	-	16	47	-	kHz
	+25°C	191	318	-	191	318	-	191	318	-	191	318	-	kHz
Output Resistance	+25°C	-	110	-	-	110	-	-	110	-	-	110	-	Ω
STABILITY														
Minimum Stable Closed Loop Gain HA-5102/5104 HA-5112/5114	Full	1	-	-	1	-	-	1	-	-	1	-	-	V/V
	Full	10	-	-	10	-	-	10	-	-	10	-	-	V/V

Specifications HA-5102/04/12/14

T-79-06-20

Electrical Specifications (Continued) V+ = 15V D.C., V- = -15V D.C., Unless Otherwise Specified

PARAMETER	TEMP	HA-5102-2, -5 HA-5112-2, -5			HA-5104-2, -5 HA-5114-2, -5			HA-5102-9 HA-5112-9			HA-5104-9 HA-5114-9			UNITS
		MIN	TYP	MAX	MIN	TYP	MAX	MIN	TYP	MAX	MIN	TYP	MAX	
TRANSIENT RESPONSE (Note 10)														
Rise Time HA-5102/5104 HA-5112/5114	+25°C	-	108	200	-	108	200	-	108	200	-	108	200	ns
	+25°C	-	48	100	-	48	100	-	48	100	-	48	100	ns
Overshoot HA-5102/5104 HA-5112/5114	+25°C	-	20	35	-	20	35	-	20	35	-	20	35	%
	+25°C	-	30	40	-	30	40	-	30	40	-	30	40	%
Slew Rate HA-5102/5104 HA-5112/5114	+25°C	±1	±3	-	±1	±3	-	±1	±3	-	±1	±3	-	V/μs
	+25°C	±12	±20	-	±12	±20	-	±12	±20	-	±12	±20	-	V/μs
Settling Time (Note 11) HA-5102/5104 HA-5112/5114	+25°C	-	4.5	-	-	4.5	-	-	4.5	-	-	4.5	-	μs
	+25°C	-	0.6	-	-	0.6	-	-	0.6	-	-	0.6	-	μs
NOISE CHARACTERISTICS														
Input Noise Voltage (Note 12) f = 10Hz f = 1kHz	+25°C	-	9	17	-	9	17	-	9	17	-	9	17	nV/√Hz
	+25°C	-	4.3	6.0	-	4.3	6.0	-	4.3	6.0	-	4.3	6.0	nV/√Hz
Input Noise Current (Note 12) f = 10Hz f = 1kHz	+25°C	-	5.1	12	-	5.1	12	-	5.1	12	-	5.1	12	pA/√Hz
	+25°C	-	0.57	3	-	0.57	3	-	0.57	3	-	0.57	3	pA/√Hz
Broadband Noise Voltage f = DC to 30kHz	+25°C	-	870	-	-	870	-	-	870	-	-	870	-	nVrms
POWER SUPPLY CHARACTERISTICS														
Supply Current HA-5102/5112 HA-5104/5114	+25°C	-	3.0	5.0	-	3.0	5.0	-	3.0	5.0	-	3.0	5.0	mA
	+25°C	-	5.0	6.5	-	5.0	6.5	-	5.0	6.5	-	5.0	6.5	mA
Power Supply Rejection Ratio (Note 6)	Full	86	100	-	86	100	-	80	100	-	80	100	-	dB

NOTES:

- Absolute maximum ratings are limiting values, applied individually, beyond which the serviceability of the circuit may be impaired. Functional operability under any of these conditions is not necessarily implied.
- For supply voltages < ±15V, the absolute maximum input voltage is equal to the supply voltage.
- Any one amplifier may be shorted to ground indefinitely.
- Derate 9.6mW/°C above TA = +25°C.
- VOUT = ±10V, RL = 2K
- VCM = ±5.0V
- Channel separation value is referred to the input of the amplifier. Input test conditions are: f = 10kHz; VIN = 200mV peak to peak; RS = 1kΩ. (Refer to Channel Separation vs. Frequency Curve for test circuits.)
- Output current is measured with VOUT = ±5V.
- Full power bandwidth is guaranteed by equation:

$$\text{Full power bandwidth} = \frac{\text{Slew Rate}}{2\pi V_{\text{peak}}}$$
- Refer to Test Circuits section of the data sheet.
- Settling time is measured to 0.1% of final value for a 1 volt input step, and AV = -10 for HA-5112/5114, and a 10 volt input step, AV = -1 for HA-5102/5104.
- Sample tested.

3
OPERATIONAL
AMPLIFIERS

Test Circuits

LARGE SIGNAL RESPONSE CIRCUIT
 Volts: 5V/Div., Time: 5 μ s/Div. ($A_v = -1$)
 HA-5102/5104

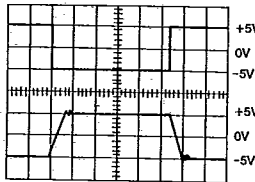
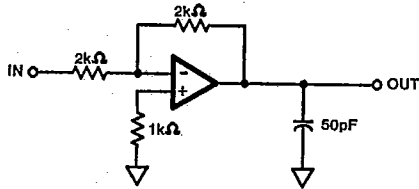

SMALL SIGNAL RESPONSE CIRCUIT
 Volts: 40mV/Div., Time: 50ns/Div. ($A_v = +1$)
 HA-5102/5104

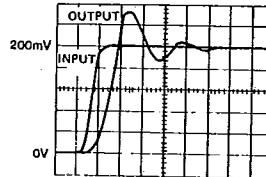
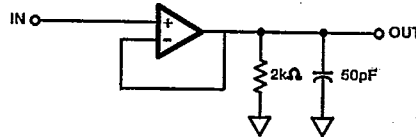

LARGE AND SMALL SIGNAL RESPONSE CIRCUIT
 HA-5112/5114 ($A_v = +10$)

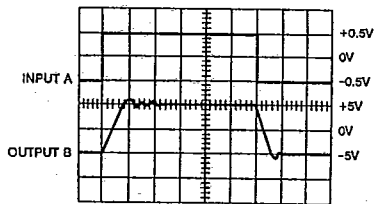
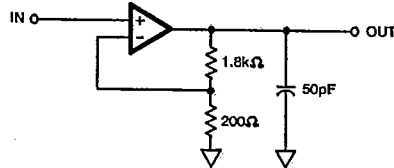

Volts: Input A: 0.5V/Div., Output B: 5V/Div.
 Time: 50ns/Div.

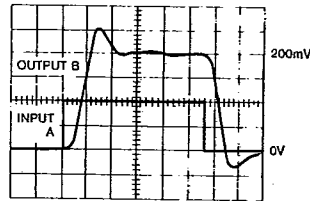

Volts: Input A: 0.01V/Div., Output B: 50mV/Div.
 Time: 50ns/Div.

SETTLING TIME CIRCUIT

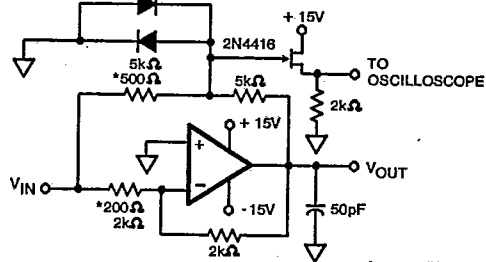

- $A_v = -1$ (HA-5102/5104), * $A_v = -10$ (HA-5112/5114)
- Feedback and summing resistors should be 0.1% matched.
- Clipping diodes are optional, HP5082-2810 recommended.

HA-5102/04/12/14

T-79-06-20

Typical Performance Curves

INPUT NOISE VOLTAGE DENSITY
 $V_{CC} = \pm 15V, T_A = +25^\circ C$

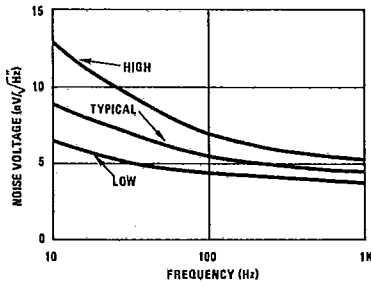

INPUT NOISE CURRENT DENSITY
 $V_{CC} = \pm 15V, T_A = +25^\circ C$

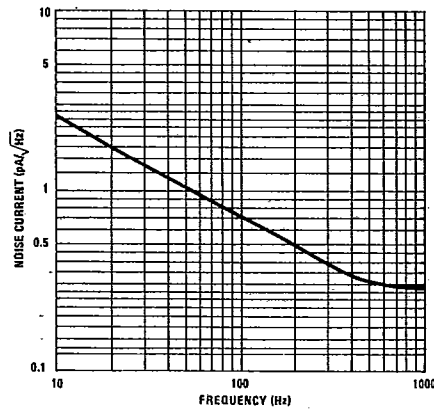

0.1Hz TO 10Hz NOISE
 $V_{CC} = \pm 15V, T_A = +25^\circ C$
 50μV/Div., 1s/Div., $A_V = 1000 V/V$
 Input Noise = 0.232μVp-p

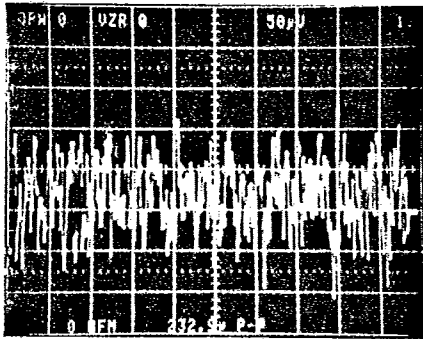

0.1Hz TO 1MHz NOISE
 $V_{CC} = \pm 15V, T_A = +25^\circ C$
 500μV/Div., 1s/Div., $A_V = 1000 V/V$
 Total Output Noise = 2.075μVp-p

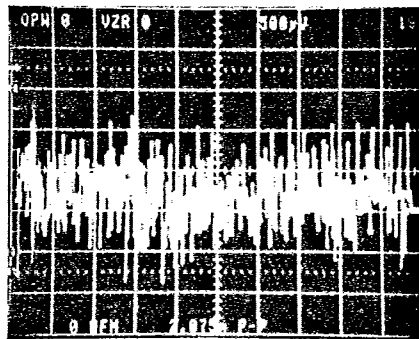

V_{IO} vs. TEMPERATURE
 $V_{CC} = \pm 15V$

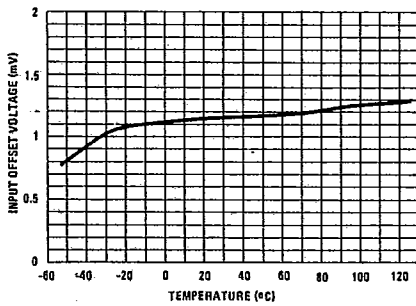

V_{IO} vs. V_{CC}
 $T_A = +25^\circ C$

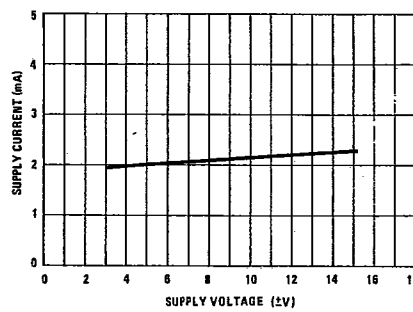

3
 OPERATIONAL AMPLIFIERS

Typical Performance Curves (Continued)

I_{IO} vs. TEMPERATURE
 $V_{CC} = \pm 15V$

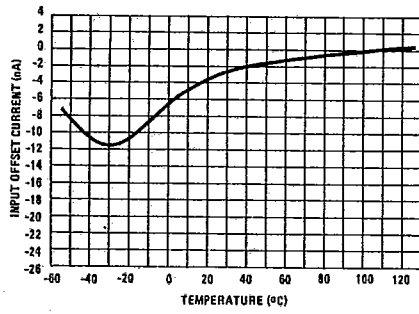

I_{BIAS} vs. TEMPERATURE
 $V_{CC} = \pm 15V$

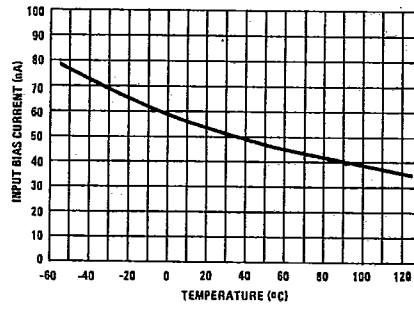

I_{CC} vs. TEMPERATURE
 $V_{CC} = \pm 15V, I_{OUT} = 0$

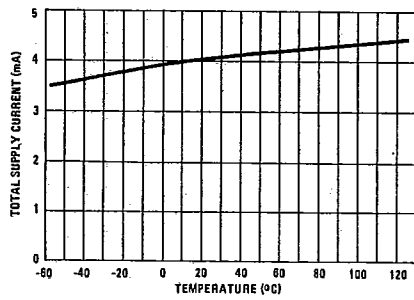

I_{CC} vs. V_{CC}
 $T_A = +25°C, I_{OUT} = 0$

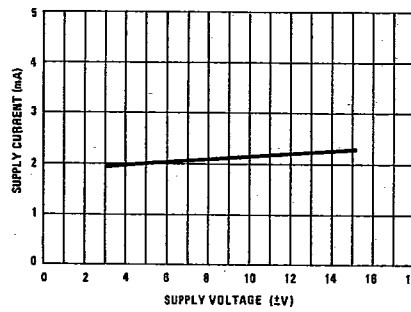

A_{VOL} vs. TEMPERATURE
 $V_{CC} = \pm 15V, \Delta V_O = \pm 10V, R_L = 2K$

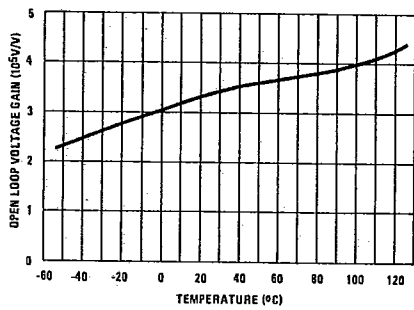

A_{VOL} vs. LOAD RESISTANCE
 $V_O = \pm 10V, V_{CC} = \pm 15V, T_A = +25°C$

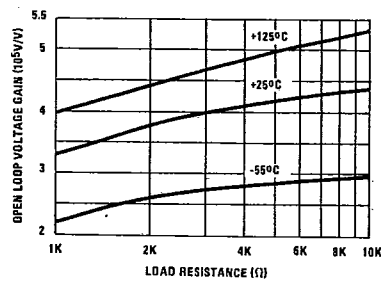

Typical Performance Curves (Continued)

AVOL vs. VCC
 $T_A = +25^\circ\text{C}, R_L = 2\text{K}$

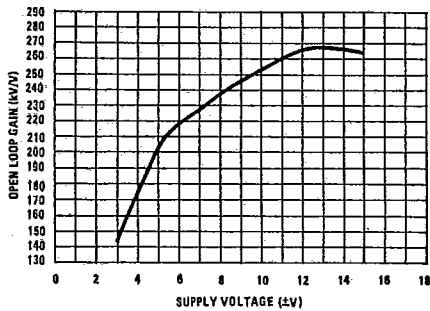

VOUT vs. VCC
 $T_A = +25^\circ\text{C}, R_L = 2\text{K}$

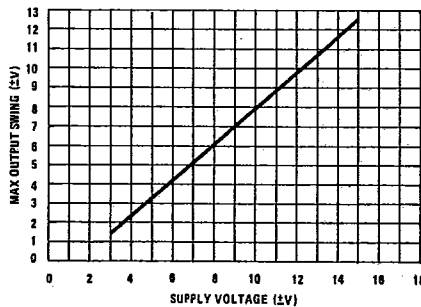

OUTPUT SHORT-CIRCUIT CURRENT vs. TIME
 $V_{CC} = \pm 15\text{V}, T_A = +25^\circ\text{C}$

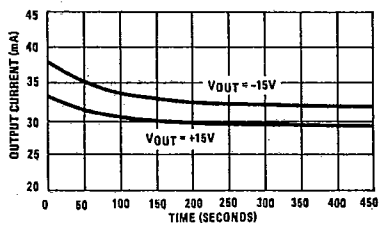

CMRR vs. FREQUENCY

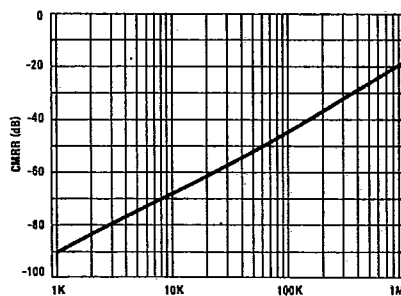

PSRR vs. FREQUENCY

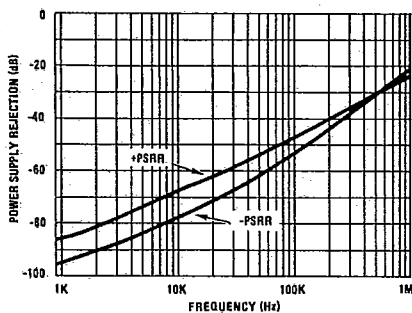

HA-5104 CHANNEL SEPARATION vs. FREQUENCY
 $10\text{Hz} \leq f \leq 10\text{MHz}$

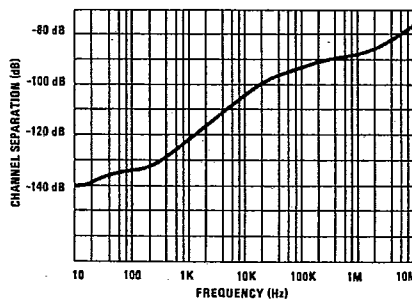

3
 OPERATIONAL
 AMPLIFIERS

HA-5102/04/12/14

T-79-06-20

Typical Performance Curves (Continued)

HA-5104/02 UNITY GAIN FREQUENCY RESPONSE
 $V_{CC} = \pm 15V, R_L = 2K, C_L = 50pF$

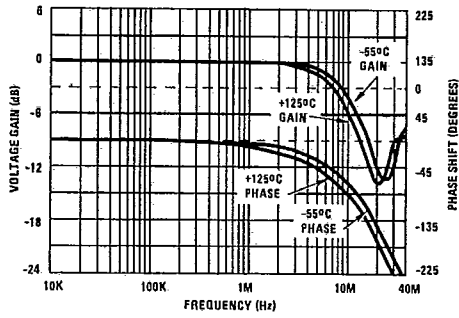

HA-5112/14 FREQUENCY RESPONSE
 $A_{VCL} = 10, T_A = +25^\circ C, R_L = 2K, C_L = 50pF$

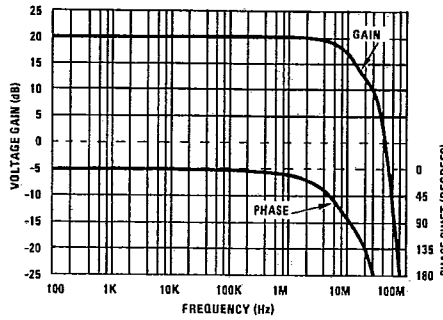

OPEN LOOP GAIN vs. FREQUENCY
 $V_{CC} = \pm 15V, R_L = 2K, C_L = 50pF, T_A = +25^\circ C$

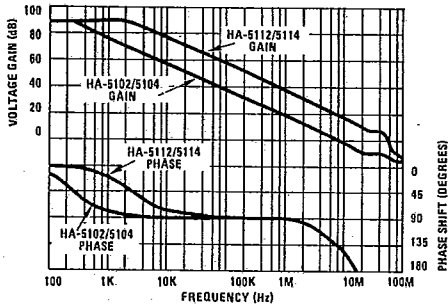

SMALL SIGNAL OVERSHOOT vs. CLOAD
 $V_{CC} = \pm 15V, T_A = +25^\circ C, R_L = 2K$

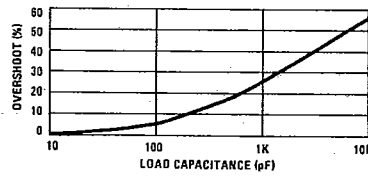

SLEW RATE vs. TEMPERATURE
 $R_L = 2K, C_L = 50pF, V_{CC} = \pm 15V$

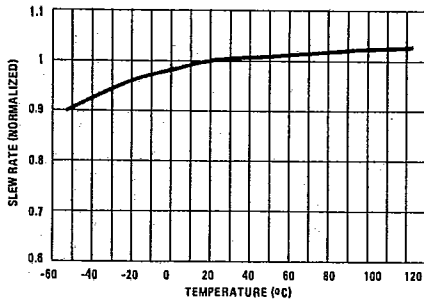

RISE TIME vs. TEMPERATURE
 $R_L = 2K, C_L = 50pF, V_{CC} = \pm 15V$

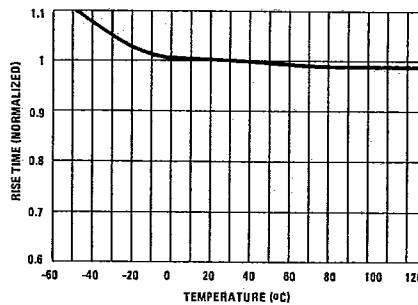

HA-5102/04/12/14

T-79-06-20

Simplified Schematic

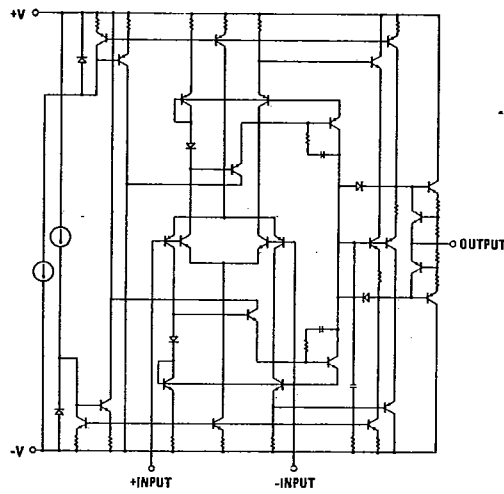

Die Characteristics

Transistor Count	Thermal Constants (°C/W)	θ_{ja}	θ_{jc}
HA-5102/5112 93	HA1-5104 (-2, -5, -7)	103	35
HA-5104/5114 175	HA1-5104 (/883)	78	25
Die Dimensions	HA2-5102/5112 (-2, -5, -7)	174	48
HA-5102/5112 98.4 x 67.3 x 19 mils (2500 x 1710 x 480 μ m)	HA2-5102/5112 (/883)	134	40
HA-5104/5114 99.6 x 95.3 x 19 mils (2530 x 2420 x 480 μ m)	HA3-5102/5112 (-5)	80	20
Substrate Potential* V-	HA3-5104/5114 (-5)	75	23
Process Bipolar-DI	HA7-5102/5112 (-2, -5, -7)	163	82
Passivation Nitride	HA7-5102/5112 (/883)	124	47
	HA9P5102/5112	160	42
	HA9P5104/5114	94	26

*The substrate may be left floating (insulating Die Mount) or it may be mounted on a conductor at V- potential.

3
 OPERATIONAL AMPLIFIERS