

High-precision MEMS 2-axis acceleration sensor

GS2 SENSOR

Discontinued products
Last time buy : 2017/12/31

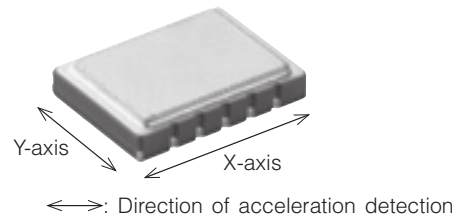

Features

- High precision, high reliability : offset temperature characteristics ± 38 mg (Typ.)
- High sensitivity : 1 to 1.333 V/g(5 V.DC)
- Line-up for various operating power supply voltages and acceleration detection ranges.
- RoHS compliant

Typical Applications

- Car Electronics : Car navigation systems, Car security, Drive recorders
- Ships and special vehicles : Marine equipment, construction/agricultural machines and welfare vehicles
- Other : Theft prevention for faculty equipment, Measuring devices (levels, measuring instruments)

Ordering Information

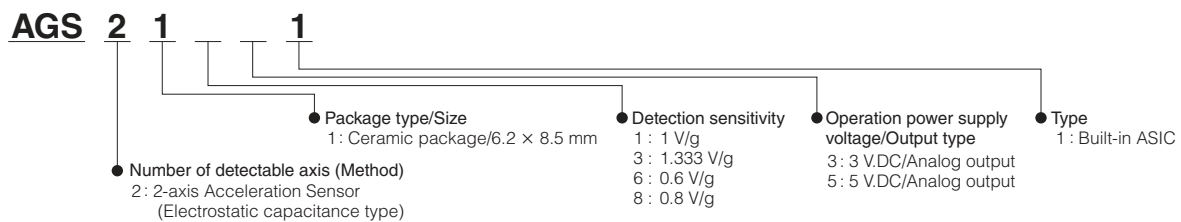

Types

Standard packing : Carton : 1,000 pcs.

Product name	Operation power supply voltage	Acceleration detection range	Detection sensitivity	Part number
2-axis Acceleration sensor GS2	3 V.DC	± 2 g	0.6V/g	AGS21631
		± 1.5 g	0.8V/g	AGS21831
	5 V.DC	± 2 g	1V/g	AGS21151
		± 1.5 g	1.333V/g	AGS21351

Absolute Maximum Ratings

Name	Unit	Absolute maximum ratings			Remarks
		Min.	Typ.	Max.	
Max. applied voltage	V	-0.3	-	7	Ta=25 °C 77 °F
Storage temperature range	°C °F	-40 -40	-	85 185	
Operation temperature range	°C °F	-40 -40	-	85 185	
Anti-shock characteristic	g	-	-	5,000	

Electrical Characteristics

Item	Unit	Performance												Remarks
		Min.				Typ.				Max.				
		AGS 21151	AGS 21351	AGS 21631	AGS 21831	AGS 21151	AGS 21351	AGS 21631	AGS 21831	AGS 21151	AGS 21351	AGS 21631	AGS 21831	
Acceleration detection range *1	g	-2	-1.5	-2	-1.5	-				2	1.5	2	1.5	
Operation power supply voltage	V.DC	4.75		2.85		5		3		5.25		3.15		-40 °C to +85 °C -40 °F to +185 °F
Current consumption	mA	-		-		2		1.8		5		5		0g, Ta=25 °C 77 °F
Sensitivity	V/g	0.975	1.3	0.585	0.78	1	1.333	0.6	0.8	1.025	1.366	0.615	0.82	Ta=25 °C 77 °F
Offset voltage (0 g)	V	2.44	2.42	1.464	1.452	2.5		1.5		2.56	2.58	1.536	1.548	Ta=25 °C 77 °F
Temperature sensitivity characteristic	%	-2				-				2				-40 °C to +85 °C -40 °F to +185 °F
Offset voltage temperature characteristic	mg	-55				-				55				-40 °C to +85 °C -40 °F to +185 °F
Other axis sensitivity *2	%	-5				-				5				Ta=25 °C 77 °F
Non-linearity *3	%FS	-1				-				1				Ta=25 °C 77 °F
Turn-on time *4	ms	-				10				-				0g, Ta=25 °C 77 °F C1=220 nF, C2, C3=27 nF
Frequency response	Hz	DC				-				60				-3 dB point, C2=27 nF

Notes : *1 The acceleration unit "g" means 9.8 m/s².

*2 VDD typical value of each part number when nothing is specified.

*3 Maximum error from linear output that connects +2 g and -2 g output. (AGS21151, AGS21631)

Maximum error from linear output that connects +1.5 g and -1.5 g output. (AGS21351, AGS21831)

*4 "C1" is a ceramic capacitor installed between the VDD and GND terminals. "C2" is a ceramic capacitor installed between the Vout (X) and Ext-Cap (X) terminals. "C3" is a ceramic capacitor installed between the Vout (Y) and Ext-Cap (Y) terminals.

*5 The frequency characteristics can be changed depending on the C2 and C3 capacitance value. Please refer to "Recommended circuit diagram" on the following page. Note that the maximum frequency response is 60 Hz

Reference Data

1. Output characteristics (AGS21151)

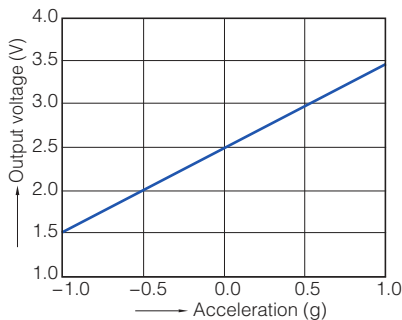

2. Inclination angle - Output voltage characteristics (AGS21151)

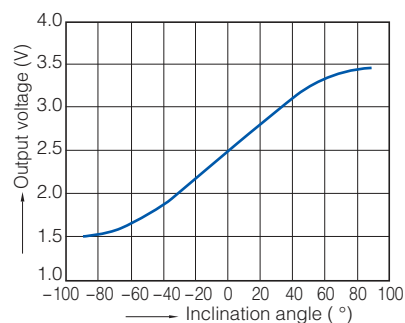

3-1 Sensitivity temperature characteristics X-axis (5 V.DC)

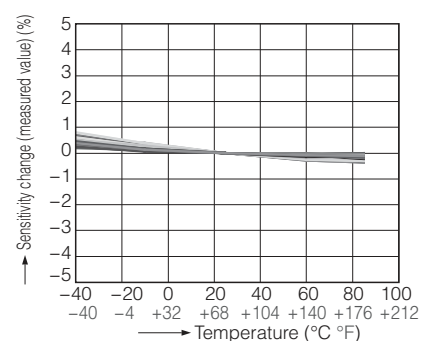

3-2 Sensitivity temperature characteristics Y-axis (5 V.DC)

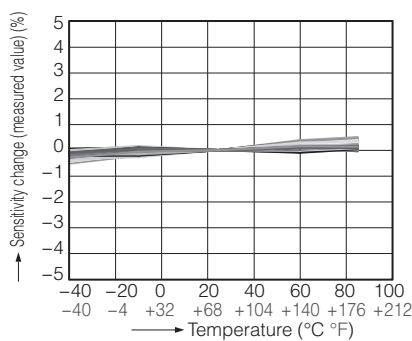

4-1 Offset voltage temperature characteristics X-axis (5 V.DC)

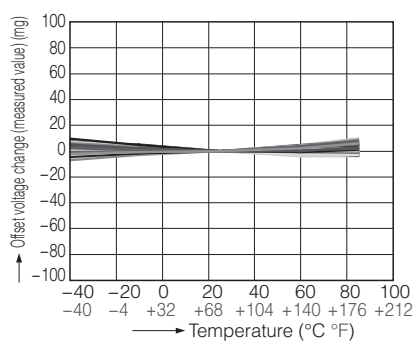

4-2 Offset voltage temperature characteristics Y-axis (5 V.DC)

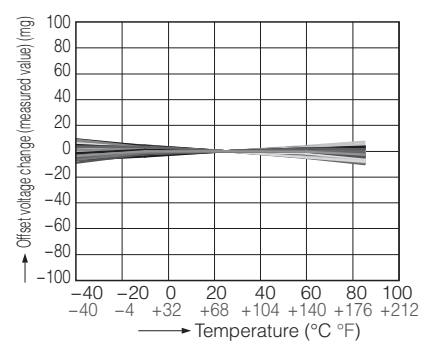

5. Frequency characteristics

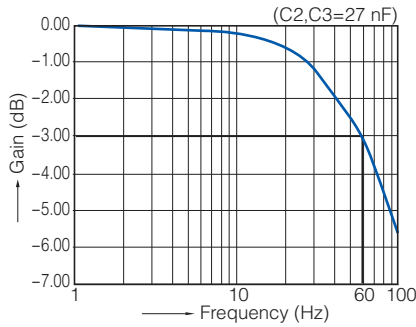

Note : The frequency characteristics can be changed depending on the C2,C3 capacitance value. Please refer to "Recommended circuit diagram" on the following page.

Dimensions

The CAD data of the products with a **CAD Data** mark can be downloaded from: <http://industrial.panasonic.com/>

CAD Data

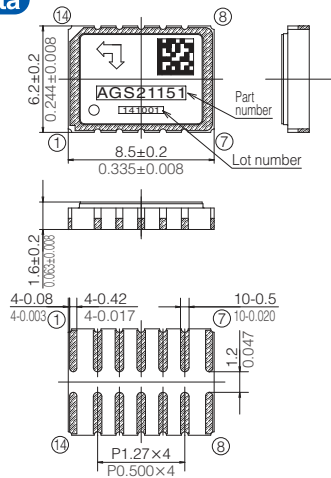

Number	Terminal Name	Number	Terminal Name
①	NC	⑧	NC
②	GND	⑨	VDD
③	NC	⑩	Ext-Cap(Y)
④	Vout(X)	⑪	Vout(Y)
⑤	Ext-Cap(X)	⑫	NC
⑥	GND	⑬	NC
⑦	NC	⑭	NC

Leave terminal "NC (No. 1, 3, 7, 8 and 12 to 14)" unconnected.

The No. 2 and No. 6 terminals are connected internally.

General tolerance : ±0.1 ±0.04

Recommended PC board pad

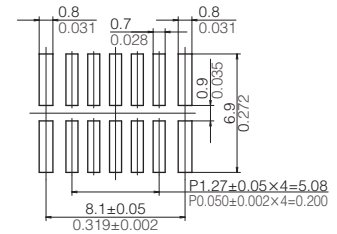

General tolerance : ±0.1 ±0.04

unit : mm inch

Recommended Circuit Diagram

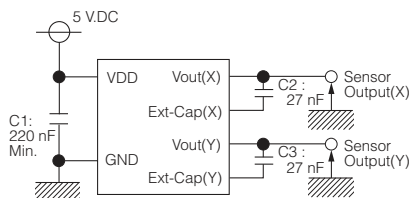

The frequency characteristics value can be changed depending on the C2 and C3 capacitance value. -3dB bandwidth is expressed in the formula below.

$$f_{-3dB} = \frac{1}{2\pi \times (100 \text{ k}\Omega) \times (C2 \text{ or } C3)}$$

Packing Format (Tape And Reel)

Tape dimensions

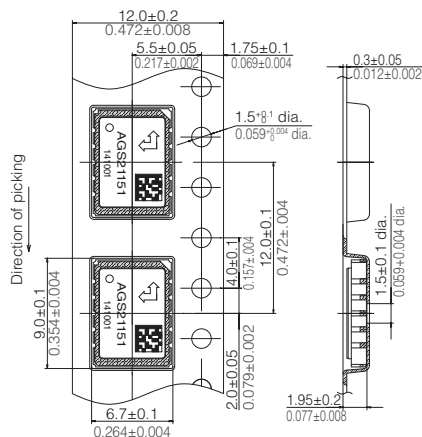

Dimensions of tape reel

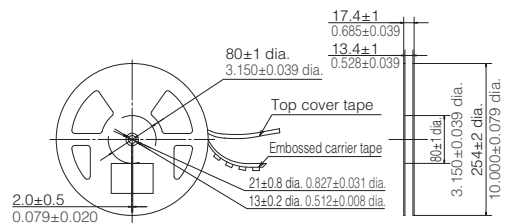

unit : mm inch

NOTES

■ Before use, carefully check the performance and quality under actual use conditions to enhance stability.

■ Mounting

- Use the land of the printed-circuit board on which the sensor is securely fixed.
- A large noise on the power supply may cause malfunction. Place the recommended capacitor near the sensor (within 20 mm 0.787 inch of the wiring pattern length) between sensor input terminals (VDD-GND) to secure power superimposed noise resistance. Test with the actual machine and re-select the capacitor with optimal capacitance.
- Prevent the metal part of other electronic components from contacting with the sensor body as the upper face (where part numbers are imprinted) of the sensor is GND.

■ Soldering

- When soldering, avoid the external thermal influence. Heat deformation may damage the sensor or deteriorate its performance.
 - Use the non-corrosive rosin flux.
 - 1) Manual soldering
 - Raise the temperature of the soldering tip between 350 and 400 °C 662 and 752 °F (30 and 60W) and solder within 3 seconds.
 - The sensor output may vary if the load is applied on the terminal during soldering.
 - Keep the soldering tip clean.
 - 2) Reflow soldering

Below are recommended temperature profiles/conditions of reflow.

 - When printing cream solder, the screen printing method is recommended.
 - For the foot pattern, see the recommended diagram of the printed-circuit board.
 - Carefully align the terminal with the pattern as self-alignment may not be reliable.
 - The temperature of the profile is the value measured near the terminal on the printed-circuit board.
 - After reflowing, when performing reflow soldering on the back surface of the circuit board, use an adhesive to fix the board.
 - 3) Rework soldering
 - Complete rework at a time.
 - Use a flattened soldering tip when performing rework on the solder bridge. Do not add the flux.
 - Keep the soldering tip below the temperature described in the specifications.
 - 4) After soldering, do not apply stress on the soldered part when cutting or bending the circuit board.
 - 5) Prevent human hands or metal pieces from contacting with the sensor terminal. Such contact may cause anomalous outlets as the terminal is exposed to the atmosphere.
 - 6) After soldering, prevent chemical agents from adhering to the sensor when applying coating to avoid insulation deterioration of the circuit board.
3. Maximum applied pressure
The maximum pressure that can be applied to the pressure sensor, after which, when the pressure is returned to below the rated pressure range, the specifications of the pressure sensor are guaranteed.

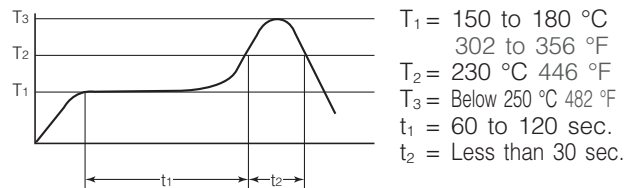

■ Wire connection

- Correctly wire as in the connection diagram. Reverse connection may damage the product and degrade the performance.
- Do not connect wires with NC terminals. Such connection may damage the sensor.

■ Cleaning

Avoid ultrasonic cleaning as this may cause disconnection of the wire.

■ Environment

- Avoid use and storage in the corrosive gas (organic solvent, sulfurous acid and hydrogen sulfide gases) which negatively affects the product.
- When installing the sensor, also install the capacitor as in the connection diagram.
- Use surge absorbers as applying the external surge voltage may damage the internal circuit.
- Malfunction may occur near electric noises from static electricity, lightning, broadcast or amateur radio stations and mobile phones.
- Avoid use in a place where these products come in contact with water.
- Avoid use in an environment where these products cause dew condensation. When water attached to the sensor chip freezes, the sensor output may be fluctuated or damaged.
- Do not apply high-frequency oscillation, such as ultrasonic waves, to the product.

■ Other precautions

- These specifications are for individual components. Before use, carefully check the performance and quality under actual use conditions to enhance stability.
- Once the individual sensor is dropped, do not use. Drop may cause functional disorders.
 - Misconnection and the wrong acceleration sensing range may invite the risk of accidents.
 - Ensure that using acceleration is within the rated range. Use beyond the range may damage the product.
 - Follow the instructions below as static electricity may damage the product.
 - (1) For storage and transportation, avoid plastic containers which are easily electrified.
 - (2) When storing and transporting the sensor, choose the environment where static electricity is hardly generated (e.g., humidity between 45 and 60 %) and protect the product by using electroconductive packaging materials.
 - (3) Once unpacked, perform antistatic countermeasures.
 - Operators handling sensors must wear antistatic cloths and human body grounding devices.
 - Cover the surface of workbench by electroconductive plates and ground measuring instruments and jigs.
 - Use the soldering iron which has a small leakage current or ground the soldering tip.
 - Ground the assembling equipment.

- (4) Use surge absorbers as applying the external surge voltage may damage the internal circuit.
(surge resistance: power supply voltage as in the absolute maximum rating)

■ Special notes

We exert maximum efforts for quality control of the product, Please mind also about the following.

- 1) To prevent occurrence of unexpected circumstances, please inform us of the specifications of your product, customers, use conditions and details of the attachment position.
- 2) Have sufficient margin values of driving/performance guarantee described in the specifications and apply safety measures with double circuits, if serious effects on human lives or property are predicted due to a quality failure of the product. Those countermeasures are also for the product liability.
- 3) A warranty period is one year after the delivery to your company. Quality assurance is limited to the items and the scopes described in the specifications. If a defect is found after the delivery, we will promptly provide a replacement or change/repair the defect part at the place of delivery in good faith. Exceptions are below.
 - Damages by a failure or a defect which arose after the delivery.
 - After the delivery, when storing and transporting, if conditions other than conditions in the specifications are applied to the product.
 - Damages by unforeseen phenomenon which cannot be predicted with the technologies available at the time of delivery.
 - Damages by natural and anthropogenic disasters, such as earthquake, flood, fire and war, which are beyond our reasonable control.