

PART No. MATRIX

E 2 2 E 0 6 0 2 1 M X X X X

E=ETHERNET/
Ethernet

HEADS:
1 = M12 D-Coding

HEADS STYLE:
060 = MALE STR / MALE STR

CABLE TYPE:
CABLE 21

UNITS:
M= METER
T=10x METER

LENGTH EXAMPLES:
005=0.5 m
010=1 m
150=15 m
T100=100 m

H= 2 PCS. OF I/D Carrier

WIRING TYPE:
E=8 Pole (STRAIGHT WIRED)

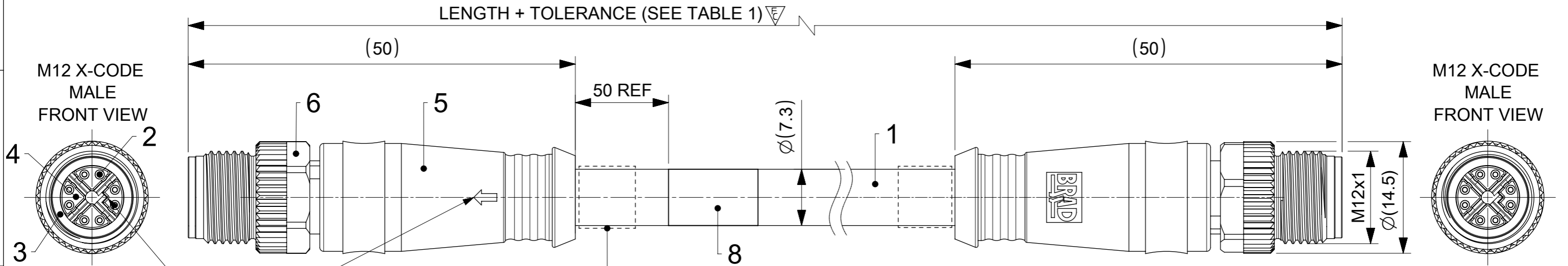

M12 X-CODE
MALE
FRONT VIEW

M12 X-CODE
MALE
FRONT VIEW

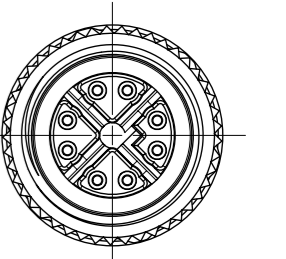
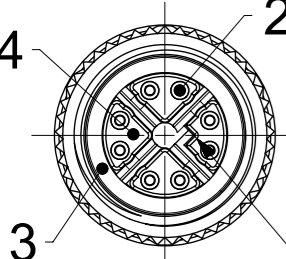

ARROW IN LINE WITH THE CODING
BRAD LOGO ON OTHER SIDE

7 ID CARRIER ONLY FOR
ENGINEERING NUMBERS
WITH THE SUFFIX "H"

M12 X-CODE MALE WIRING DIAGRAM M12 X-CODE MALE

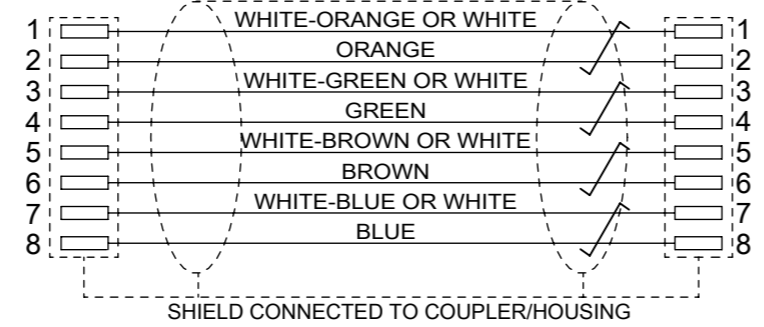

M12 X-CODE
MALE
FRONT VIEW

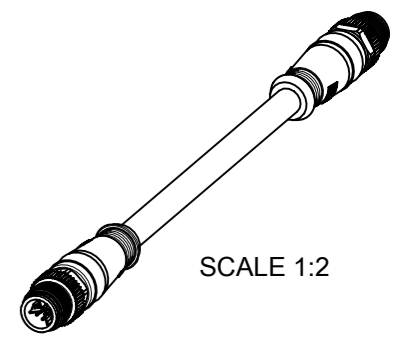
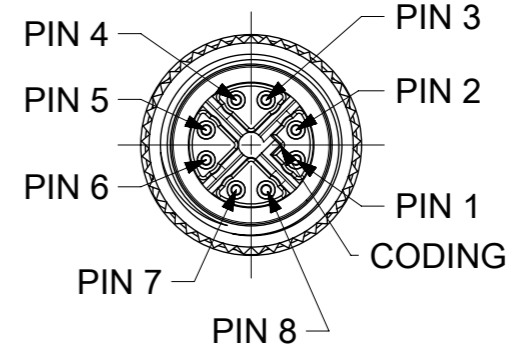

SCALE 1:2

BILL OF MATERIAL

ITEM	QTY	DESCRIPTION	MATERIAL	FINISH/COLOR
1	1	CABLE 4X(2X AWG26/7) CAT 7	TPE	GREEN
2	16	CONTACT M12 XC MALE	BRASS	Au PLATED
3	2	SHIELD SLEEVE	Zn	Ni PLATED
4	2	INSERT M12 XC MALE	PA	BLACK
5	-	MOULDING MATERIAL	TPU	BLACK
6	2	M12 HYBRID COUPLING NUT	BRASS	Ni PLATED
7	2	I/D CARRIER 6-10mmx30mm	PVC	TRANSPARENT
8	1	LABEL 2.0X1.75	VINYL	YELLOW

DOCUMENT STATUS: P1 | RELEASE DATE: 2023/01/31 10:45:36

FUNCTIONAL SYMBOLS ∇A = 0 ∇E = 1 ∇V = 0	THIS DRAWING CONTAINS INFORMATION THAT IS PROPRIETARY TO MOLEX ELECTRONIC TECHNOLOGIES, LLC AND SHOULD NOT BE USED WITHOUT WRITTEN PERMISSION TO THE DRAWING	CURRENT REV DESC: NEW PN 1203411133 ADDED TO THE DRAWING				
	GENERAL TOLERANCES (UNLESS SPECIFIED)	EC NO: 736740				CSE M12 CAT6A 8P XC MA STR TPE XM
	ANGULAR TOL ± 1.0°	4 PLACES ±	DRWN: FDAFERNER	2023/01/31	PRODUCT CUSTOMER DRAWING	
	3 PLACES ±	2 PLACES ± 0.05	CHK'D: RSILLER	2023/01/31	DOCUMENT NUMBER: 1203410863	
DIVISIONAL SYMBOLS	2 PLACES ± 0.3	APPR: RSILLER	2023/01/31	DOC TYPE: PSD	DOC PART: 000	
1 PLACE ± 0.5	0 PLACES ± 0.5	INITIAL REVISION:	2019/05/13	REVISION: A6		
DRAFT WHERE APPLICABLE MUST REMAIN WITHIN DIMENSIONS	THIRD ANGLE PROJECTION	DRWN: RSCHEIBER	2020/12/09	SHEET NUMBER: 1 OF 2		
		APPR: RSILLER				
		DRAWING: A3-SIZE	SERIES: 120341	MATERIAL NUMBER: SEE TABLE 1	CUSTOMER: GENERAL MARKET	

TABLE 1

MOLEX P/N	ENGINEERING NO.	DESCRIPTION	LENGTH
1203410941	E22E06021M003	M12 CAT6A M/M ST/ST TPE GREEN 0.3M	300
1203410863	E22E06021M005	M12 CAT6A M/M ST/ST TPE GREEN 0.5M	500
1203410864	E22E06021M010	M12 CAT6A M/M ST/ST TPE GREEN 1M	1000
1203410865	E22E06021M020	M12 CAT6A M/M ST/ST TPE GREEN 2M	2000
1203410866	E22E06021M030	M12 CAT6A M/M ST/ST TPE GREEN 3M	3000
1203410867	E22E06021M040	M12 CAT6A M/M ST/ST TPE GREEN 4M	4000
1203410868	E22E06021M050	M12 CAT6A M/M ST/ST TPE GREEN 5M	5000
1203410869	E22E06021M060	M12 CAT6A M/M ST/ST TPE GREEN 6M	6000
1203410895	E22E06021M070	M12 CAT6A M/M ST/ST TPE GREEN 7M	7000
1203410870	E22E06021M080	M12 CAT6A M/M ST/ST TPE GREEN 8M	8000
1203410896	E22E06021M090	M12 CAT6A M/M ST/ST TPE GREEN 9M	9000
1203410871	E22E06021M100	M12 CAT6A M/M ST/ST TPE GREEN 10M	10000
1203410942	E22E06021M120	M12 CAT6A M/M ST/ST TPE GREEN 12M	12000
1203410943	E22E06021M140	M12 CAT6A M/M ST/ST TPE GREEN 14M	14000
1203410872	E22E06021M150	M12 CAT6A M/M ST/ST TPE GREEN 15M	15000
1203410944	E22E06021M180	M12 CAT6A M/M ST/ST TPE GREEN 18M	18000
1203410873	E22E06021M200	M12 CAT6A M/M ST/ST TPE GREEN 20M	20000
1203410945	E22E06021M230	M12 CAT6A M/M ST/ST TPE GREEN 23M	23000
1203410946	E22E06021M270	M12 CAT6A M/M ST/ST TPE GREEN 27M	27000
1203410947	E22E06021M300	M12 CAT6A M/M ST/ST TPE GREEN 30M	30000
1203410948	E22E06021M340	M12 CAT6A M/M ST/ST TPE GREEN 34M	34000
1203410949	E22E06021M380	M12 CAT6A M/M ST/ST TPE GREEN 38M	38000
1203410950	E22E06021M420	M12 CAT6A M/M ST/ST TPE GREEN 42M	42000
1203410951	E22E06021M460	M12 CAT6A M/M ST/ST TPE GREEN 46M	46000
1203410952	E22E06021M500	M12 CAT6A M/M ST/ST TPE GREEN 50M	50000
1203410953	E22E06021M540	M12 CAT6A M/M ST/ST TPE GREEN 54M	54000
1203410954	E22E06021M570	M12 CAT6A M/M ST/ST TPE GREEN 57M	57000
1203410955	E22E06021M610	M12 CAT6A M/M ST/ST TPE GREEN 61M	61000
1203410956	E22E06021M650	M12 CAT6A M/M ST/ST TPE GREEN 65M	65000
1203410957	E22E06021M700	M12 CAT6A M/M ST/ST TPE GREEN 70M	70000
1203411133	E22E06021M950	M12 CAT6A M/M ST/ST TEAL TPE 95M	95000

TABLE 1

WITH ID CARRIER			
MOLEX P/N	ENGINEERING NO.	DESCRIPTION	LENGTH
1203410999	E22E06021M005H	M12 CAT6A M/M ST/ST TPE GREEN 0.5M-ID	500
1203411031	E22E06021M010H	M12 CAT6A M/M ST/ST TPE GREEN 1M-ID	1000
1203411032	E22E06021M020H	M12 CAT6A M/M ST/ST TPE GREEN 2M-ID	2000
1203411033	E22E06021M030H	M12 CAT6A M/M ST/ST TPE GREEN 3M-ID	3000
1203411034	E22E06021M040H	M12 CAT6A M/M ST/ST TPE GREEN 4M-ID	4000
1203411003	E22E06021M050H	M12 CAT6A M/M ST/ST TPE GREEN 5M-ID	5000
1203411092	E22E06021M060H	M12 CAT6A M/M ST/ST TPE GREEN 6M-ID	6000
1203411093	E22E06021M070H	M12 CAT6A M/M ST/ST TPE GREEN 7M-ID	7000
1203411094	E22E06021M080H	M12 CAT6A M/M ST/ST TPE GREEN 8M-ID	8000
1203411000	E22E06021M100H	M12 CAT6A M/M ST/ST TPE GREEN 10M-ID	10000
1203411035	E22E06021M120H	M12 CAT6A M/M ST/ST TPE GREEN 12M-ID	12000
1203411036	E22E06021M150H	M12 CAT6A M/M ST/ST TPE GREEN 15M-ID	15000
1203411037	E22E06021M200H	M12 CAT6A M/M ST/ST TPE GREEN 20M-ID	20000
1203410918	E22E06021M250H	M12 CAT6A M/M ST/ST TPE GREEN 25M-ID	25000
1203410919	E22E06021M300H	M12 CAT6A M/M ST/ST TPE GREEN 30M-ID	30000
1203410920	E22E06021M350H	M12 CAT6A M/M ST/ST TPE GREEN 35M-ID	35000
1203410978	E22E06021M400H	M12 CAT6A M/M ST/ST TPE GREEN 40M-ID	40000
1203410979	E22E06021M450H	M12 CAT6A M/M ST/ST TPE GREEN 45M-ID	45000
1203410921	E22E06021M500H	M12 CAT6A M/M ST/ST TPE GREEN 50M-ID	50000
1203410980	E22E06021M550H	M12 CAT6A M/M ST/ST TPE GREEN 55M-ID	55000
1203411001	E22E06021M600H	M12 CAT6A M/M ST/ST TPE GREEN 60M-ID	60000
1203410981	E22E06021M650H	M12 CAT6A M/M ST/ST TPE GREEN 65M-ID	65000
1203410982	E22E06021M700H	M12 CAT6A M/M ST/ST TPE GREEN 70M-ID	70000
1203410983	E22E06021M750H	M12 CAT6A M/M ST/ST TPE GREEN 75M-ID	75000
1203411002	E22E06021M850H	M12 CAT6A M/M ST/ST TPE GREEN 85M-ID	85000
1203411038	E22E06021M800H	M12 CAT6A M/M ST/ST TPE GREEN 80M-ID	80000

NOTES:
 VOLTAGE RATING: 48 V
 CURRENT RATING: 0.5 A
 TEMPERATURE RATING:
 STATIC: -40 °C TO 80 °C
 DYNAMIC: -25 °C TO 80 °C
 IP RATING: IP 67 (IN MATED AND LOCKED CONDITION)
 TRANSMISSION CHARACTERISTICS ACCORDING TO ISO/IEC 11801 CLASS E_A CHANNEL,
 WITH INSERTION LOSS BEING IGNORED FOR CABLE LENGTHS <1 m OR >65 m
 PACKAGING: CORDSETS ARE PACKED IN A POLYBAG

CABLE LENGTH TOLERANCES

LENGTH	TOLERANCE
0 m - 1 m	+40 mm
>1 m - 5 m	+60 mm
>5 m - 10 m	+80 mm
>10 m - 20 m	+140 mm
>20 m - 30 m	+160 mm
>30 m	+1% length

FUNCTIONAL SYMBOLS	THIS DRAWING CONTAINS INFORMATION THAT IS PROPRIETARY TO MOLEX ELECTRONIC TECHNOLOGIES, LLC AND SHOULD NOT BE USED WITHOUT WRITTEN PERMISSION	
$\nabla_A = 0$	DIMENSION UNITS: mm	SCALE: 1:1
$\nabla_F = 0$	CURRENT REV DESC: NEW PN 1203411133 ADDED TO THE DRAWING	
$\nabla_P = 0$	GENERAL TOLERANCES (UNLESS SPECIFIED)	
DIVISIONAL SYMBOLS	ANGULAR TOL ± 1.0 °	EC NO: 736740
	4 PLACES ±	DRWN: FDAFERNER 2023/01/31
	3 PLACES ±	CHK'D: RSILLER 2023/01/31
	2 PLACES ± 0.05	APPR: RSILLER 2023/01/31
	1 PLACE ± 0.3	INITIAL REVISION:
	0 PLACES ± 0.5	DRWN: RSCHIEBER 2019/05/13
	DRAFT WHERE APPLICABLE MUST REMAIN WITHIN DIMENSIONS	APPR: RSILLER 2020/12/09
	THIRD ANGLE PROJECTION	DRAWING
		SERIES
	A3-SIZE	MATERIAL NUMBER
	120341	CUSTOMER
	SEE TABLE 1	GENERAL MARKET
		SHEET NUMBER
		2 OF 2



CSE M12 CAT6A 8P XC MA STR TPE XM

PRODUCT CUSTOMER DRAWING

DOCUMENT NUMBER	DOC TYPE	DOC PART	REVISION
1203410863	PSD	000	A6