

AMPMODU Interconnection System

RoHS
Ready 



Table of Contents

1 PC/104 and PC/104-Plus Connectors

2 .050 x .050 [1.27 x 1.27] Centerline

3 .050 x .100 [1.27 x 2.54] Centerline

4 AMPMODU 2mm Connectors

5 .100 x .100 [2.54 x 2.54] Centerline

6 .125 x .125 [3.18 x 3.18] Centerline

7 .156 [3.96] Centerline

8 Shunts

1 PC/104 and PC/104-Plus Connectors

Introduction5

PC/104, Press Fit6, 7

PC/104-Plus, Press Fit8, 9

PC/104, Solder10

PC/104-Plus, Solder11

Accessories, Kits12

2 0.050 [1.27] x 0.050 [1.27] CENTERLINE AMPMODU 50/50 Grid

Board-to-Board Vertical Receptacles and Headers:

Introduction13, 14

Vertical Receptacles, Double Row15

Vertical Headers, Double Row16

Recommended PC Board Layouts17

Board-to-Board Right-Angle Headers:

Introduction18

Right-Angle Headers, Double Row, Latching and Non-Latching19

Cable-to-Board Connectors:

Introduction20

Receptacle Connectors, Double Row, With and Without Latch21

Cable Connector Terminating Cover, Double Row22

IDC (Insulation Displacement Crimp) Tooling23

Performance Specifications24

Technical Documents24

3 .050 [1.27] x 0.100 [2.54] CENTERLINE AMPMODU System 5025

Board-to-Board Connectors, Thru-Hole:

Introduction26

Headers, Shrouded and Unshrouded27-35

Introduction36

Receptacles37-40

PC Board Hole Layouts41, 42

Board-to-Board Connectors, Surface-Mount:

Introduction43

Headers44

Receptacles45

Cable-to-Board Connectors, FFC Cable:

Introduction46

Flexible Flat Conductor Cable47

FFC Contacts48

Receptacle Housings49-52

ZIF-Line Connectors53, 54

Cable-to-Board Connectors, Ribbon Cable:

Introduction55

Ribbon Cable Receptacles56

Paddleboard Receptacles57

Flat Ribbon Cable58, 59

Application Tooling for Flex Film Contacts60

Application Tooling60-62

Performance Specifications63

Technical Documents64

Table of Contents (Continued)

| | | |
|----------|--|----------|
| 4 | AMPMODU 2mm Connectors | |
| | AMPMODU 2mm Connectors (Board to Board) | 65 |
| | Headers, Unshrouded, Double Row, Thru-Hole Mount | 66, 67 |
| | Breakaway Headers, Unshrouded, Double Row, Thru-Hole Mount | 68-70 |
| | Breakaway Headers, Unshrouded, Double Row, Surface Mount | 71, 72 |
| | Stacking Header, Unshrouded, Double Row, Thru-Hole Mount | 73 |
| | Headers, Shrouded, Double Row, Thru-Hole, Right-Angle Mount | 74, 75 |
| | Headers, Shrouded, Double Row, Surface Mount | 76, 77 |
| | Headers, Shrouded, Double Row, Thru-Hole Mount with Cable Shrouds | 78, 79 |
| | Receptacles, Double Row, Thru-Hole, Vertical Mount | 80, 81 |
| | Receptacles, Double Row, Surface Mount, Right-Angle Mount | 82 |
| | Receptacles, Double Row, Thru-Hole, Right-Angle Mount | 83 |
| | Receptacles, Double Row, Surface Mount, Vertical Mount | 84 |
| 5 | .100 [2.54] x .100 [2.54] CENTERLINE | |
| | Introduction | 85-87 |
| | Terms Explained | 87 |
| | Wire Sizes | 88 |
| | Contact Platings | 88 |
| | Mating Post Lengths | 88 |
| | Application Tooling | 88 |
| | Board-to-Board Solutions Guides, .100[2.54] Centerline Products | 89 |
| | Wire-to-Board Solutions Guide, .100[2.54] Centerline Products | 89 |
| | Mating Post Selection Guide | 90 |
| | Parallel Stacking Guide for Board-to-Board Applications | 91 |
| | Board-to-Board Products: | |
| | Unshrouded Headers | 92-100 |
| | Breakaway and Retention Headers-Unshrouded | 101-105 |
| | Reeled Breakaway Headers | 106, 107 |
| | Surface Mount Breakaway Headers | 108-110 |
| | Unshrouded Stacking Headers- Breakaway | 111-113 |
| | Shrouded Headers | 114-140 |
| | Standard Profile | 114-133 |
| | Low Profile | 134-140 |
| | Shrouded Stacking Headers | 141-144 |
| | ACTION PIN Headers | 145-149 |
| | ACTION PIN Press-Fit Posts | 150, 151 |
| | Application Tooling for ACTION PIN Posts | 152, 153 |
| | ACTION PIN Stacking Connectors | 154-161 |
| | Application Tooling for AMP ACTION PIN Stacking Connectors | 162 |
| | 0.025 [0.64] Square Posts | 163 |
| | 0.025 [0.64] Square Continuous Posts | 164, 165 |
| | 0.045 [1.14] Square Continuous Posts | 166, 167 |
| | Horizontal Mount Receptacle Assemblies, Mod II | 168-173 |
| | Vertical Mount Receptacle Assemblies, Mod II & Mod IV | 174-184 |
| | Surface Mount Vertical Receptacles, Mod IV | 185-192 |
| | Two-Piece Printed Circuit Board Connectors | 193-202 |
| | Accessories | 203-205 |
| | Wire-to-Board Products: | |
| | Locking Clip Contacts and Housings | 206-209 |
| | Mod IV Contacts and Housings | 210-220 |
| | Short Point Contacts and Housings | 221-224 |
| | MTE Interconnection System | 225-250 |
| | Surface Mount MTE Headers (Right-Angle & Vertical) | 251, 252 |
| | Interchangeable Contacts, Wire Crimp (Snap-In) | 253, 254 |
| | MT and Shielded MT Connectors | 255-265 |
| | Mini-Tandem Spring Receptacle Contacts | 266-269 |
| | Application Tooling | 270-275 |
| | Technical Documents | 276-278 |

1
PC/104 and PC/104-Plus Connectors

2
.050 x .050 [1.27 x 1.27] Centerline

3
.050 x .100 [1.27 x 2.54] Centerline

4
AMPMODU 2mm Connectors

5
.100 x .100 [2.54 x 2.54] Centerline

6
.125 x .125 [3.18 x 3.18] Centerline

7
.156 [3.96] Centerline

8
Shunts

Table of Contents (Continued)

PC/104 and PC/104-Plus Connectors
1

.050 x .050 [1.27 x 1.27] Centerline
2

.050 x .100 [1.27 x 2.54] Centerline
3

AMPMODU 2mm Connectors
4

.100 x .100 [2.54 x 2.54] Centerline
5

.125 x .125 [3.18 x 3.18] Centerline
6

.156 [3.96] Centerline
7

Shunts
8

6 .125 [3.18] x .125 [3.18] CENTERLINE
Wire-to-Board Product:
Level V IDC Connectors279-282

7 .156 [3.96] CENTERLINE
Mod I 0.031 x 0.062 Interconnection System
Introduction283, 284
Receptacles, Vertical and Horizontal Board Mount285, 286
Receptacle Assemblies, Vertical and Horizontal Board Mount287-289
Receptacles, Crimp Snap-In (Wire Applied)290
Receptacle Housings, Standard Profile-Unkeyed (With/Without Strain Relief) ...291, 292
Receptacle Housings, Low Profile-Keyed293
Posts, Machined Applied294
Headers:
Straight Post, Keyed295, 296
Right-Angle, Keyed297
Locking Clip Contacts, Crimp Snap-In (Wire Applied)298
Locking Clip Connector Housings, Single Row, Crimp Snap-In299
Application Tooling300-304
Performance Specifications305
Technical Documents305

8 Shunts
Dual In-Line Package DIP Shunts306, 307
Post Shunts308-310
Performance Specifications311
Technical Documents311
Part Number Index313-316

Restriction on the use of Hazardous Substances (RoHS)

At TE Connectivity (TE), we're ready to support your RoHS requirements. We've assessed more than 1.5 million end items/components for RoHS compliance, and issued new part numbers where any change was required to eliminate the restricted materials. Part numbers in this catalog are identified as:

RoHS Compliant — Part numbers in this catalog are RoHS Compliant, unless marked otherwise. These products comply with European Union Directive 2002/95/EC as amended 1 January 2006 that restricts the use of lead, mercury, cadmium, hexavalent chromium, PBB, and PBDE in certain electrical and electronic products sold into the EU as of 1 July 2006.

NOTE: For purposes of this catalog, included within the definition of RoHS Compliant are products that are clearly "Out of Scope" of the RoHS Directive such as hand tools and other non-electrical accessories.

NOTE: Information regarding RoHS compliance is provided based on reasonable inquiry of our suppliers and represents our current actual knowledge based on the information provided by our suppliers. This information is subject to change. For latest compliance status, refer to our website referenced at right.

Getting the Information You Need

Our comprehensive on-line RoHS Customer Support Center provides a forum to answer your questions and support your RoHS needs. A RoHS FAQ (Frequently Asked Questions) is available with links to more detailed information. You can also submit RoHS questions and receive a response within 24 hours during a normal work week. The Support Center also provides:

- Cross-Reference from Non-compliant to Compliant Products
- Ability to browse RoHS Compliant Products in our on-line catalog
- Downloadable Technical Data Customer Information Presentation
- More detailed information regarding the definitions used above
- So whatever your questions when it comes to RoHS, we have the answers at www.te.com/leadfree



PC/104 and PC/104-Plus Connectors

Product Facts

- Press fit design — eliminates hand soldering
- Unitized PC/104 connector assembly — eliminates two piece (64 pin & 40 pin) configuration
- Integral board spacers with captive hardware — eases & improves assembly efficiency while minimizing stocked hardware
- “Flat-rock” insertable — no need for complex insertion tooling
- Recognized by Underwriters' Laboratories to US and Canadian standards  file No. E28476
- Fully compliant with PC104 & PC104-Plus standards
- Solutions available for lead free processes (ie. ENIG and silver immersion plated PCB's)

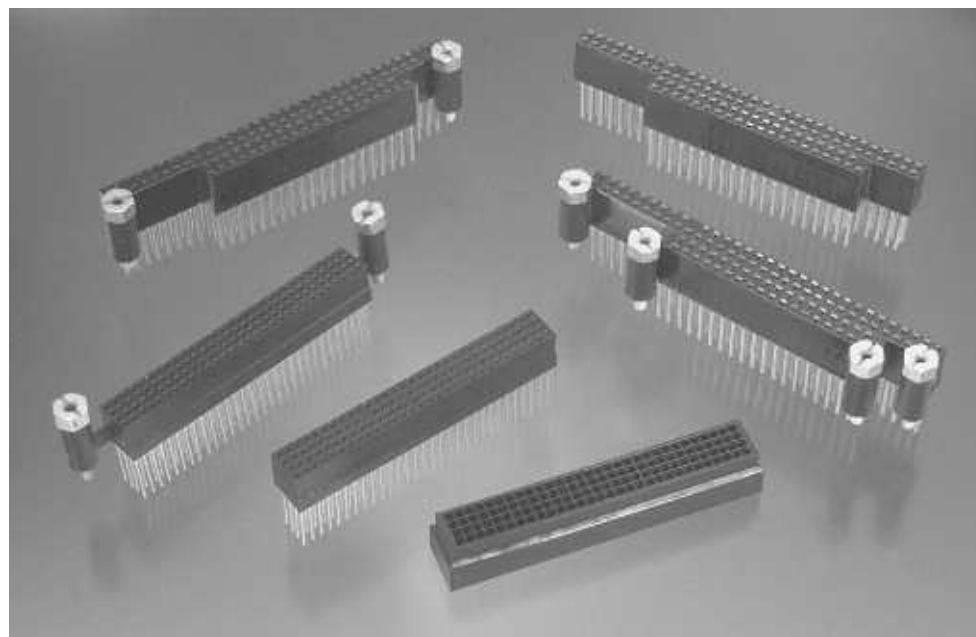
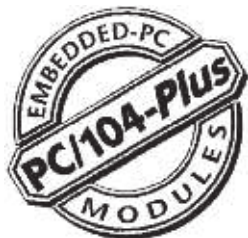

The PC/104 and PC/104-Plus connectors are industry standard product offerings which comply with the interconnection requirements defined by the PC/104 organization (<http://www.pc104.org>)

Both products are designed specifically for “flat-rock” press-fit installation for ease of application. Solder version is also available.

Optional integral standoffs minimize the customer's system assembly time.

The TE offering of the standard PC/104 product is a unitized connector rather than the two piece, 40 and 64 position connectors currently on the market. Customer needs to stock and apply only one part number rather than two.

Performance Specifications

Electrical Characteristics

Meets requirements of PC/104 and PC/104-Plus standards

Nominal Resistance — 10 milliohms maximum, ΔR

Insulation Resistance — 1000 megohms minimum

Dielectric Withstanding Voltage — 500 VAC for 1 min. at sea level

Mechanical Characteristics

Meets requirements of PC/104 and PC/104-Plus standards

Current — Signal application only

Temperature — -55° to 105°C

Material and Finish

Housing — Black Thermoplastic, UL 94V-0

Contact — Phosphor Bronze, Full Gold all over Nickel (stackthrough), Gold on mating end, Tin or Tin-lead on PCB tail all over Nickel (non-stackthrough)

Need more information?

Call Technical Support 1-800-522-6752:

Technical Support is staffed with specialists well versed in all TE products. The Center can provide you with:

- Technical Support
- Catalogs
- Technical Documents
- TE Authorized Distributor Locations

Technical Documents

Product Specifications

108-1956

Application Specifications

114-13021

| Connector | Centerline | Position |
|-------------|--------------|----------|
| PC/104 | .100 2.54 | 104* |
| PC/104-Plus | .079 2.0 | 120** |

*Two circuits plugged per PC/104 specification. Other options available.

**One circuit plugged per PC/104-Plus specification. Other options available.

PC/104, Press-Fit

Material and Finish

Housing — Glass filled thermoplastic, Black, 94V-0 rated

Contacts

Stackthrough — Phosphor Bronze; plated .000015 [0.00038] min. Gold on mating receptacle end, .000005 [0.000130] min. Gold on remainder, all over .000050 [0.00127] Nickel

or
Phosphor Bronze; plated .000015 [0.00038] min. Gold on mating receptacle end, .000100-.000200 [0.000254-.000508] matte tin on compliant section, .000005 [0.000130] min. Gold on remainder of post, all over .000050 [0.00127] Nickel

Non-Stackthrough — Phosphor Bronze; plated .000015 [0.00038] min. Gold on mating receptacle end, .000100 [0.00254] matte tin or tin-lead on remainder, all over .000050 [0.00127] Nickel

Screwlocks — Steel, Clear Chromate over Zinc

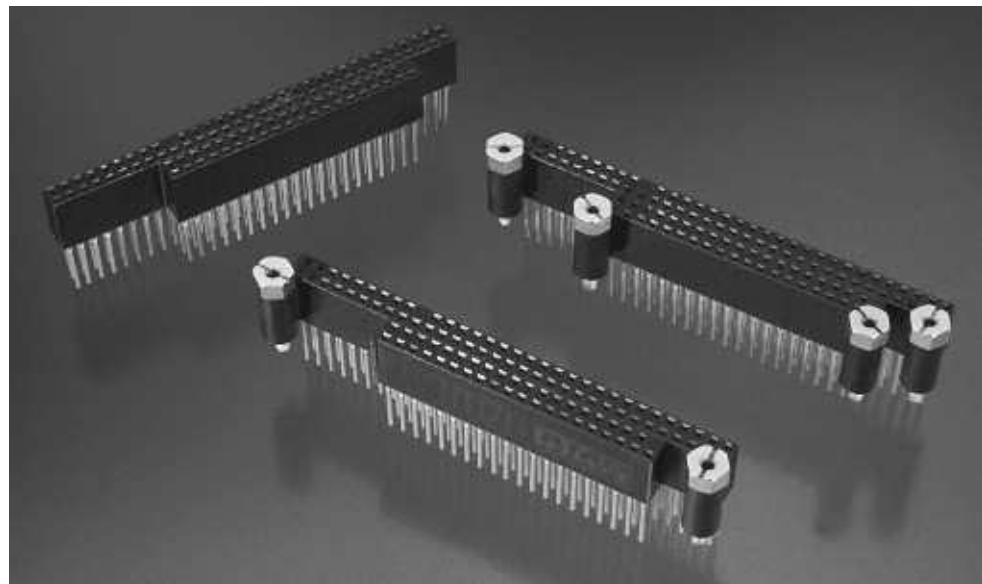

Stackthrough, No Standoffs

Gold plated contacts*

Part No. 1375795-1 (keyed), **Part No. 1375795-2** (unkeyed)

Gold plated contacts with Tin plated compliant pin section**

Part No. 1375795-3 (keyed), **Part No. 1375795-4** (unkeyed)

Non-Stackthrough, No Standoffs

Tin-lead plated tails*

Part No. 1375796-1 (keyed), **Part No. 1375796-2** (unkeyed)

Matte tin plated tails**

Part No. 1375796-3 (keyed), **Part No. 1375796-4** (unkeyed)

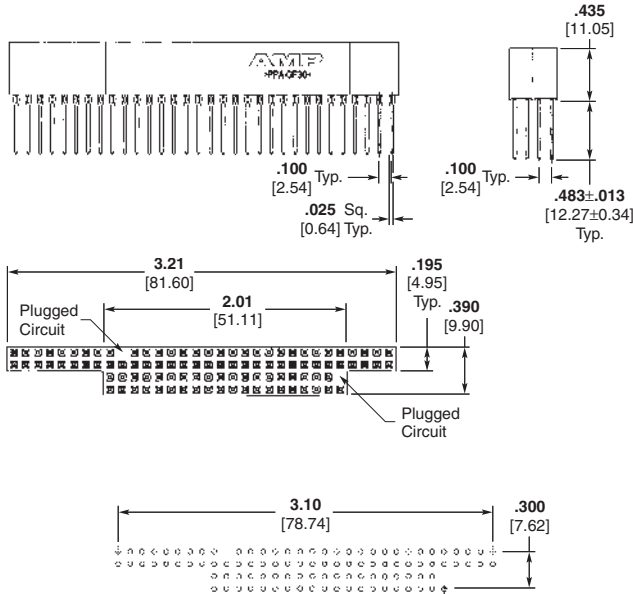

Keyed

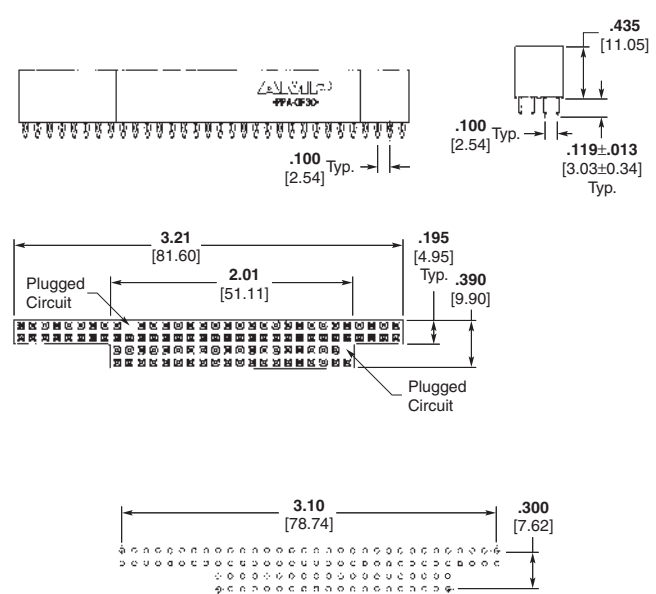

Unkeyed

Recommended PC Board Layout
See Customer Drawing for
Hole Geometry and Recommended Plating.

Note: All part numbers are RoHS compliant.

* For RoHS exempt Tin-lead processes (including ENIG Plated PCB's)

** for Silver Immersion processes or where a total lead free solution is desired

PC/104, Press-Fit (Continued)

Stackthrough, 2 Standoffs

Gold plated contacts*

Part No. 1375793-1 (keyed), Part No. 1375793-2 (unkeyed)

Gold plated contacts with Tin plated compliant pin section**

Part No. 1375793-3 (keyed), Part No. 1375793-4 (unkeyed)

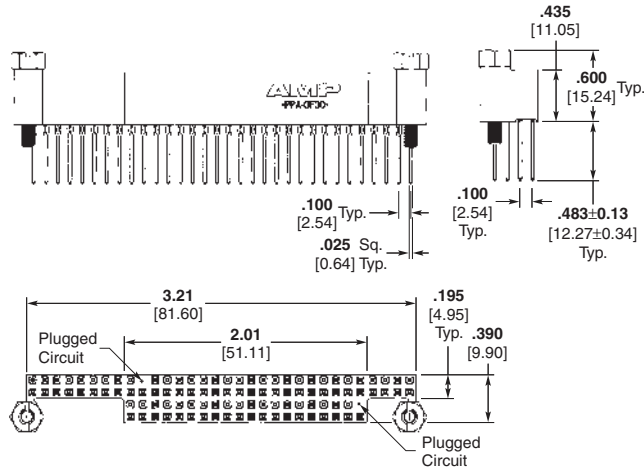

Non-Stackthrough, 2 Standoffs

Tin-lead plated tails*

Part No. 1375794-1 (keyed), Part No. 1375794-2 (unkeyed)

Matte tin plated tails**

Part No. 1375794-3 (keyed), Part No. 1375794-4 (unkeyed)

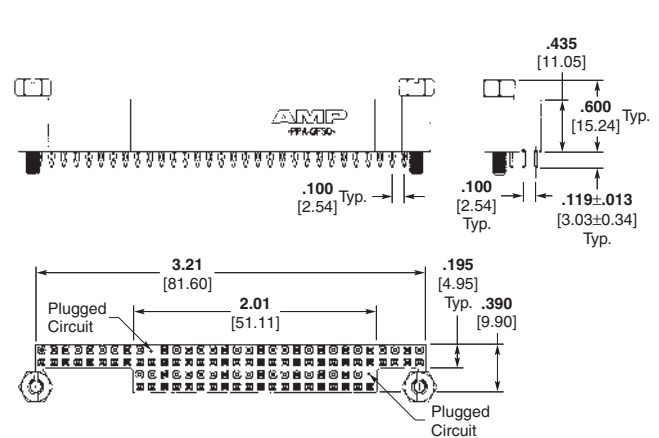

Stackthrough, 4 Standoffs

Gold plated contacts*

Part No. 1375791-1 (keyed), Part No. 1375791-2 (unkeyed)

Gold plated contacts with Tin plated compliant pin section**

Part No. 1375791-3 (keyed), Part No. 1375791-4 (unkeyed)

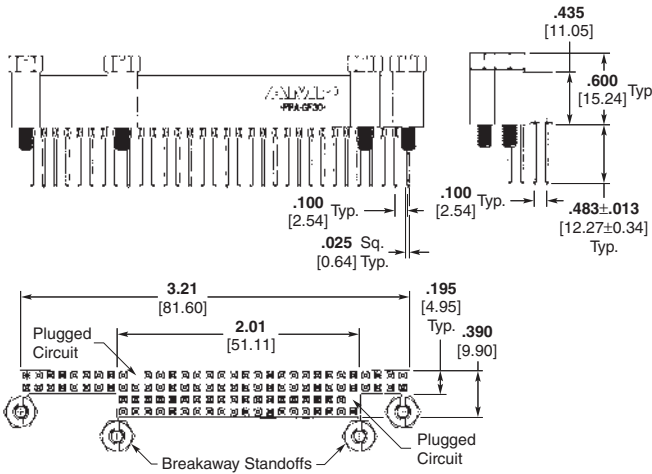

Non-Stackthrough, 4 Standoffs

Tin-lead plated tails*

Part No. 1375792-1 (keyed), Part No. 1375792-2 (unkeyed)

Matte tin plated tails**

Part No. 1375792-3 (keyed), Part No. 1375792-4 (unkeyed)

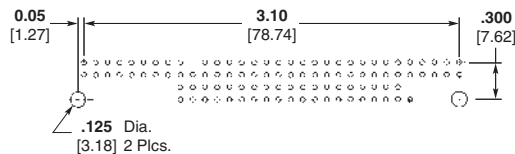
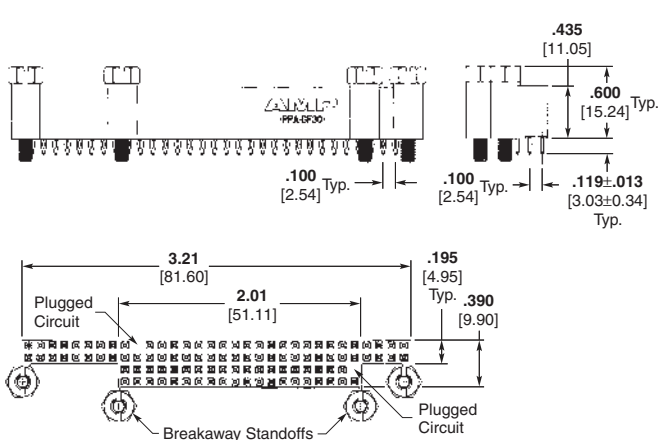

Keyed

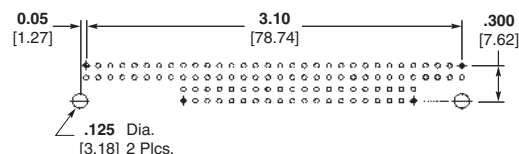

Unkeyed

Recommended PC Board Layout
See Customer Drawing for
Hole Geometry and Recommended Plating.

Note: All part numbers are RoHS compliant.

* For RoHS exempt Tin-lead processes (including ENIG Plated PCB's)

** for Silver Immersion processes or where a total lead free solution is desired

PC/104-Plus, Press-Fit

Material and Finish

Housing — Glass filled thermoplastic, Black, 94V-0 rated

Contacts

Stackthrough — Phosphor Bronze; plated .000015 [0.00038] min. Gold on mating receptacle end, .000005 [0.000130] min. Gold on remainder, all over .000050 [0.00127] Nickel

or
Phosphor Bronze; plated .000015 [0.00038] min. Gold on mating receptacle end, .000100-.000200 [0.000254-.00508] matte tin on compliant section, .000005 [0.000130] min. Gold on remainder of post, all over .000050 [0.00127] Nickel

Non-Stackthrough — Phosphor Bronze; plated .000015 [0.00038] min. Gold on mating receptacle end, .000100 [0.00254] matte tin or tin-lead on remainder, all over .000050 [0.00127] Nickel

Screwlocks — Steel, Clear Chromate over Zinc

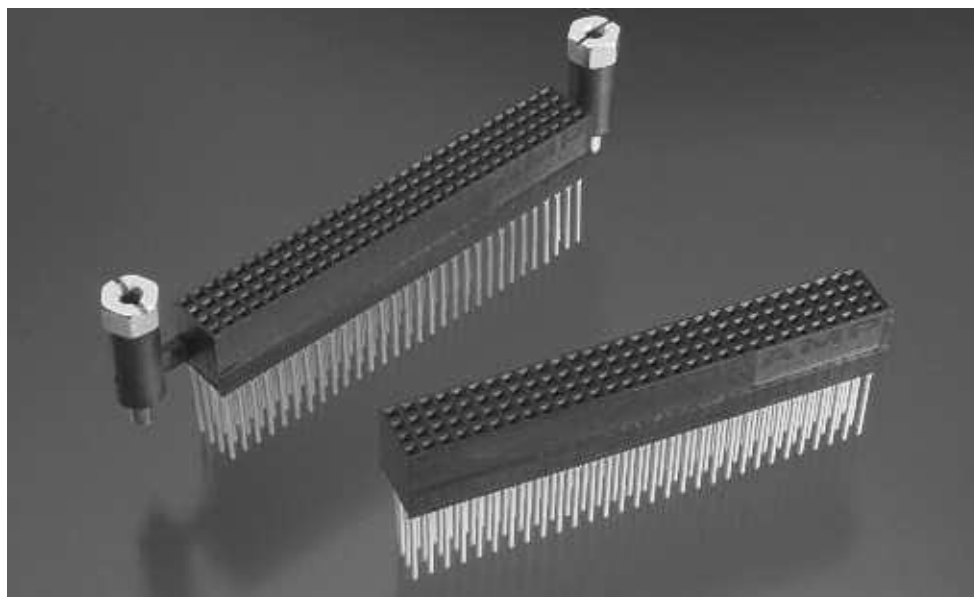

Stackthrough, No Standoffs

Gold plated contacts*

- Part No. 1375799-1 (unkeyed)
- Part No. 1375799-2 (keyed-A1) per PC/104-Plus specification
- Part No. 1375799-3 (keyed-D30) per PC/104-Plus specification

Gold plated contacts with Tin plated compliant pin section**

- Part No. 1375799-4 (unkeyed)
- Part No. 1375799-5 (keyed-A1) per PC/104-Plus specification
- Part No. 1375799-6 (keyed-D30) per PC/104-Plus specification

Non-Stackthrough, No Standoffs

Tin-lead plated tails*

- Part No. 1375800-1 (unkeyed)
- Part No. 1375800-2 (keyed-A1) per PC/104-Plus specification
- Part No. 1375800-3 (keyed-D30) per PC/104-Plus specification

Matte tin plated tails**

- Part No. 1375800-4 (unkeyed)
- Part No. 1375800-5 (keyed-A1) per PC/104-Plus specification
- Part No. 1375800-6 (keyed-D30) per PC/104-Plus specification

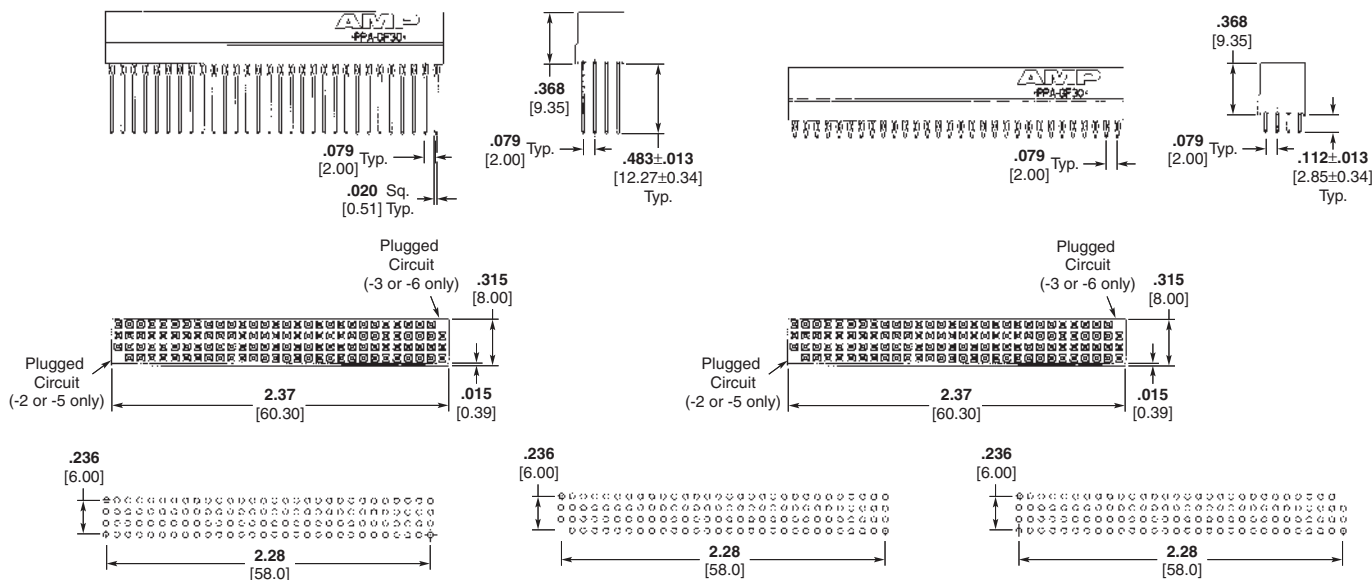

Recommended PC Board Layout for 1375799-1, 1375799-4, 1375800-1, 1375800-4

Recommended PC Board Layout for 1375799-2, 1375799-5, 1375800-2, 1375800-5

Recommended PC Board Layout for 1375799-3, 1375799-6, 1375800-3, 1375800-6

See Customer Drawing for Hole Geometry and Recommended Plating. (Including ENIG plated PCB's)

Note: All part numbers are RoHS compliant.

* For RoHS exempt Tin-lead processes (including ENIG Plated PCB's)

** for Silver Immersion processes or where a total lead free solution is desired

PC/104-Plus, Press-Fit (Continued)

Non-Stackthrough, 2 Standoffs

- Tin-lead plated tails*
 - Part No. 1375798-1 (unkeyed)
 - Part No. 1375798-2 (keyed-A1) per PC/104-Plus specification
 - Part No. 1375798-3 (keyed-D30) per PC/104-Plus specification

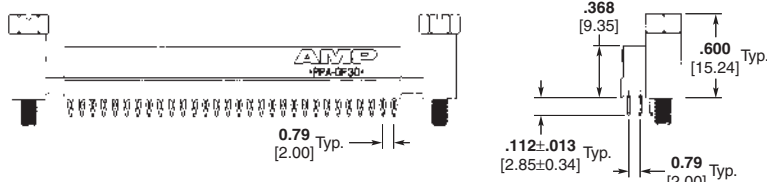

Matte tin plated tails**

- Part No. 1375798-4 (unkeyed),
- Part No. 1375798-5 (keyed-A1) per PC/104-Plus specification
- Part No. 1375798-6 (keyed-D30) per PC/104-Plus specification

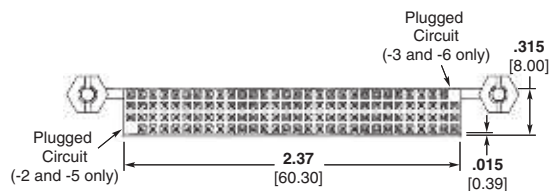

Stackthrough, 2 Standoffs

- Gold plated contacts*
 - Part No. 1375797-1 (unkeyed)
 - Part No. 1375797-2 (keyed-A1) per PC/104-Plus specification
 - Part No. 1375797-3 (keyed-D30) per PC/104-Plus specification

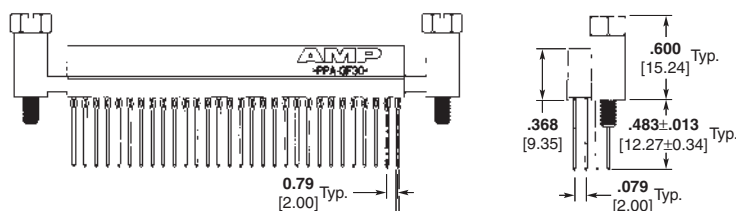

Gold plated contacts with Tin plated compliant pin section**

- Part No. 1375797-4 (unkeyed)
- Part No. 1375797-5 (keyed-A1) per PC/104-Plus specification
- Part No. 1375797-6 (keyed-D30) per PC/104-Plus specification

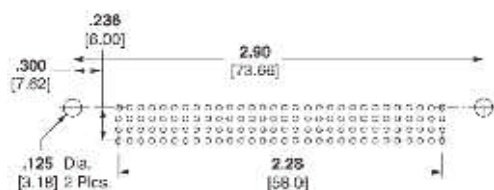
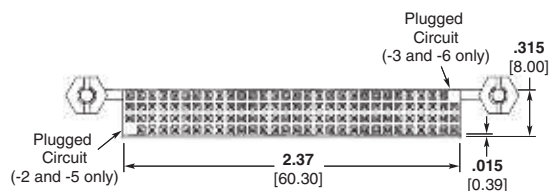

Recommended PC Board Layout for 1375797-1, 1375797-4, 1375798-1, 1375798-4

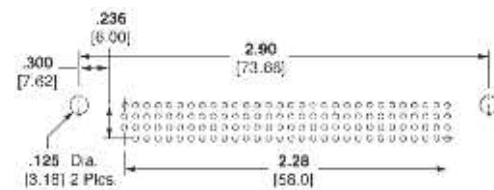

Recommended PC Board Layout for 1375797-2, 1375797-5, 1375798-2, 1375798-5

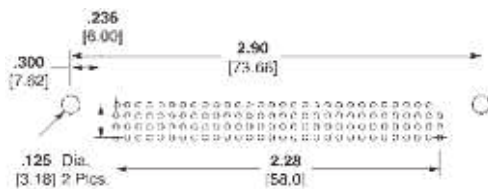

Recommended PC Board Layout for 1375797-3, 1375797-6, 1375798-3, 1375798-6

See Customer Drawing for Hole Geometry and Recommended Plating.

Note: All part numbers are RoHS compliant.

* For RoHS exempt Tin-lead processes (including ENIG Plated PCB's)

** for Silver Immersion processes or where a total lead free solution is desired

PC/104, Solder

Material and Finish

Housing — Glass filled thermoplastic, Black, 94V-0 rated

Contacts

Non-Stackthrough — Phosphor Bronze; plated .000015 [0.00038] min. Gold on mating receptacle end, .000100 [0.00254] matte tin on remainder, all over .000050 [0.00127] Nickel

Screwlocks — Steel, Clear Chromate over Zinc

Non-Stackthrough, No Standoffs

Part No. 1375963-3 (keyed)
Part No. 1375963-4 (unkeyed)

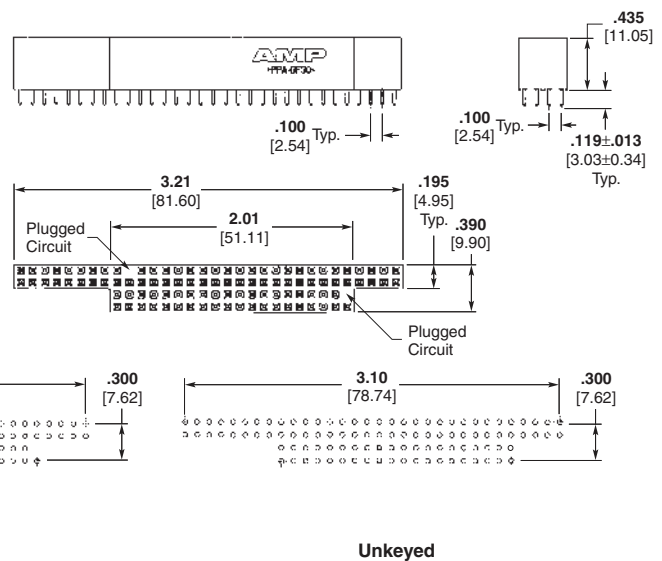

Recommended PC Board Layout

Non-Stackthrough, 2 Standoffs

Part No. 1375961-3 (keyed)
Part No. 1375961-4 (unkeyed)

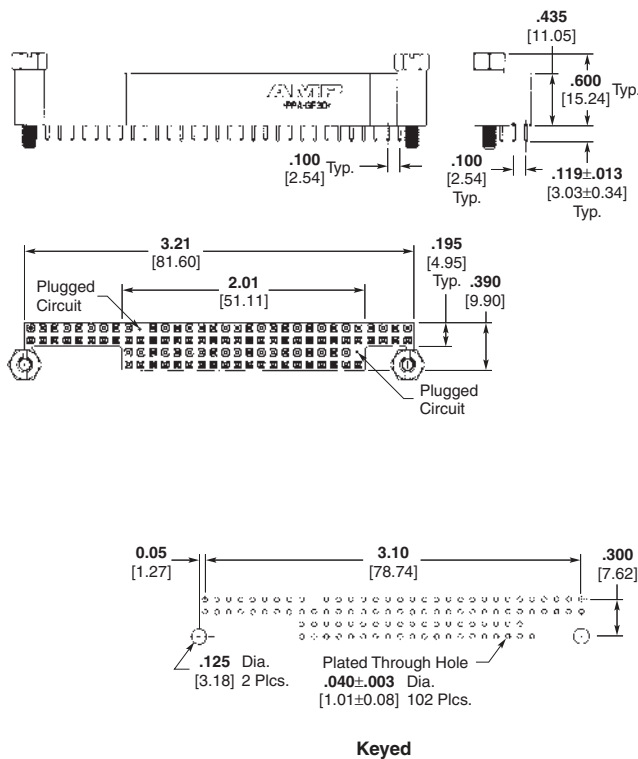

Recommended PC Board Layout

Non-Stackthrough, 4 Standoffs

Part No. 1375959-3 (keyed)
Part No. 1375959-4 (unkeyed)

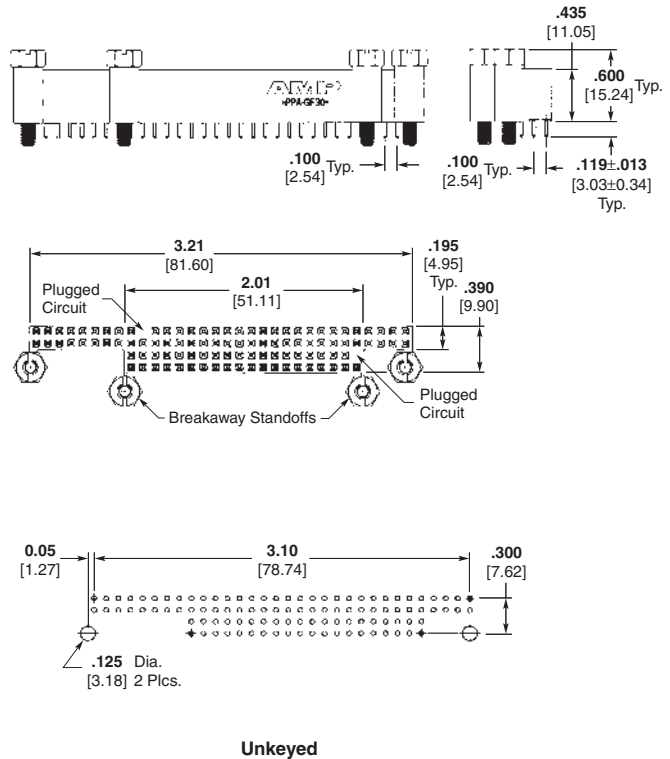

Note: All part numbers are RoHS compliant.

PC/104-Plus, Solder

Material and Finish

Housing — Glass filled thermoplastic, Black, 94V-0 rated

Contacts

Non-Stackthrough — Phosphor Bronze; plated .000015 [0.00038] min. Gold on mating receptacle end, .000100 [0.00254] matte tin on remainder, all over .000050 [0.00127] Nickel

Screwlocks — Steel, Clear Chromate over Zinc

Non-Stackthrough, No Standoffs

Part No. 1375967-4 (unkeyed)

Part No. 1375967-5 (keyed-A1)

per PC/104-Plus specification

Part No. 1375967-6 (keyed-D30)

per PC/104-Plus specification

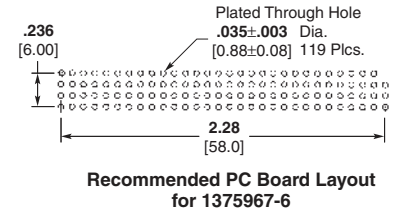
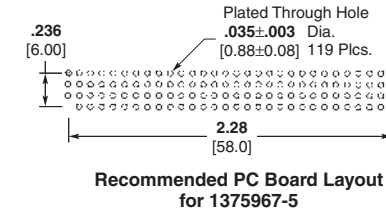
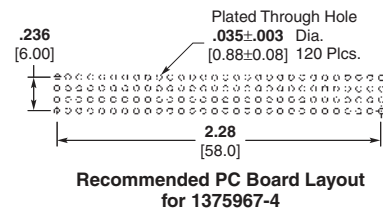
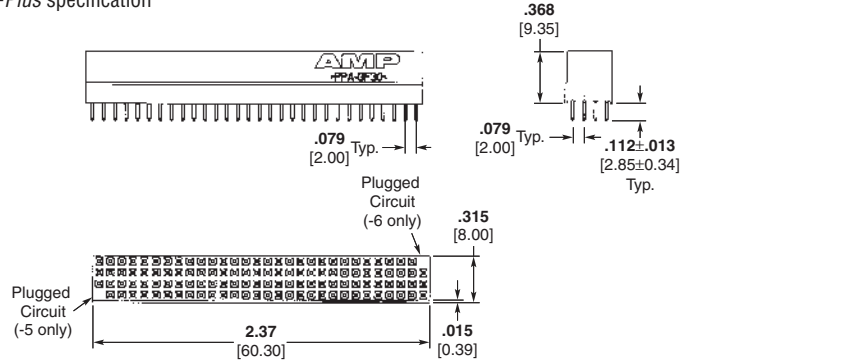

Non-Stackthrough, 2 Standoffs

Part No. 1375965-4 (unkeyed)

Part No. 1375965-5 (keyed-A1)

per PC/104-Plus specification

Part No. 1375965-6 (keyed-D30)

per PC/104-Plus specification

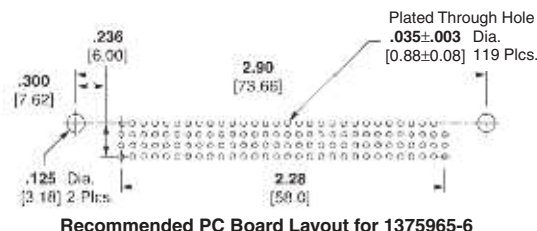
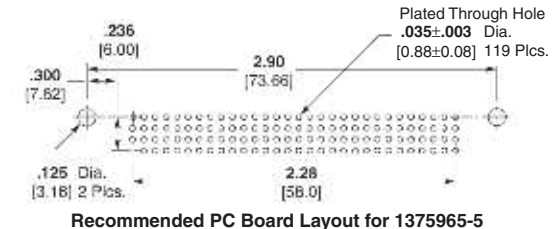
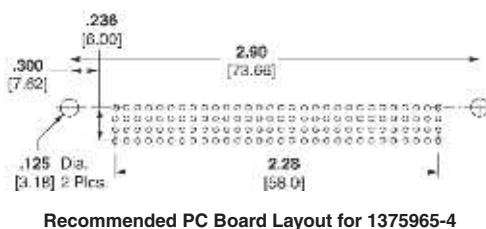
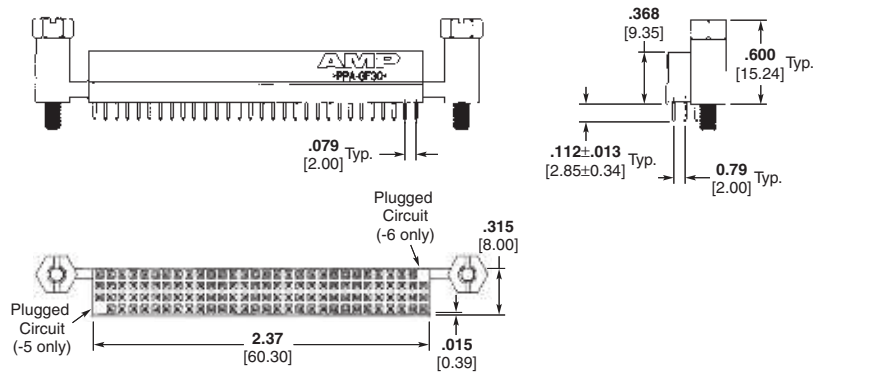

Note: All part numbers are RoHS compliant.

Accessories

Shroud, PC/104-Plus Part No. 1375801-1

Material — PBT, Black

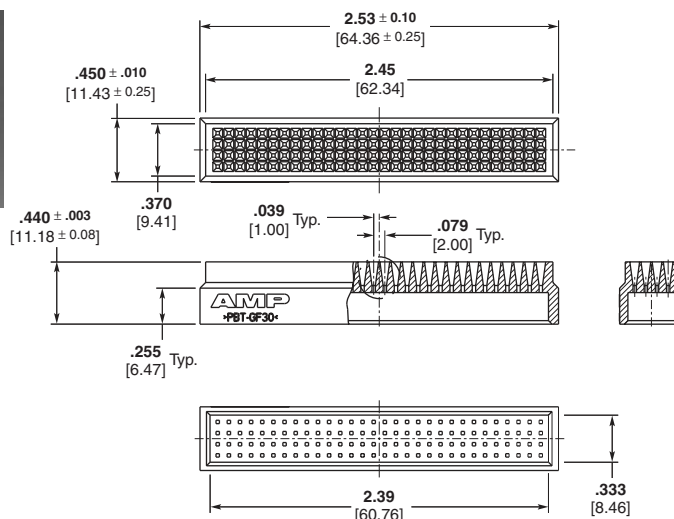
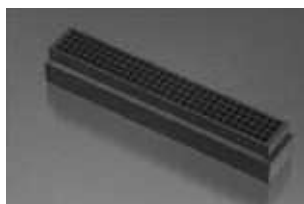

Organizer, PC/104 Part Number 1445251-1

Material — Polyester, PBT, Black

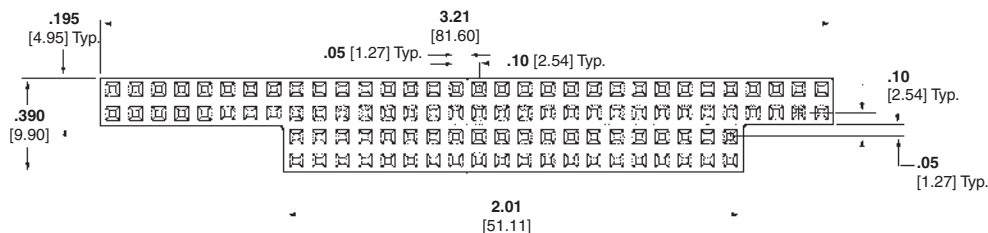

Kit Packaging Part Numbers

| Part Number | Component Part Number | | Style |
|-------------|-----------------------|-----------|---------|
| | Connector Assembly | Organizer | |
| 1445441-3 | 1375795-3 | 1445251-1 | Keyed |
| 1445441-4 | 1375795-4 | 1445251-1 | Unkeyed |
| 1445440-3 | 1375793-3 | 1445251-1 | Keyed |
| 1445440-4 | 1375793-4 | 1445251-1 | Unkeyed |
| 1445439-3 | 1375791-3 | 1445251-1 | Keyed |
| 1445439-4 | 1375791-4 | 1445251-1 | Unkeyed |

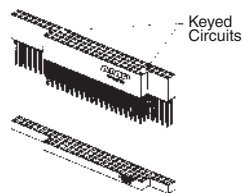

Part No. 1445441-3

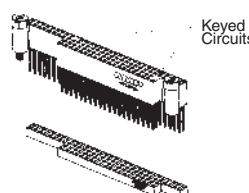

Part No. 1445440-3

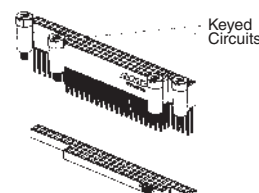

Part No. 1445439-3

Note: All part numbers are RoHS compliant.

AMPMODU 50/50 Grid Connector System

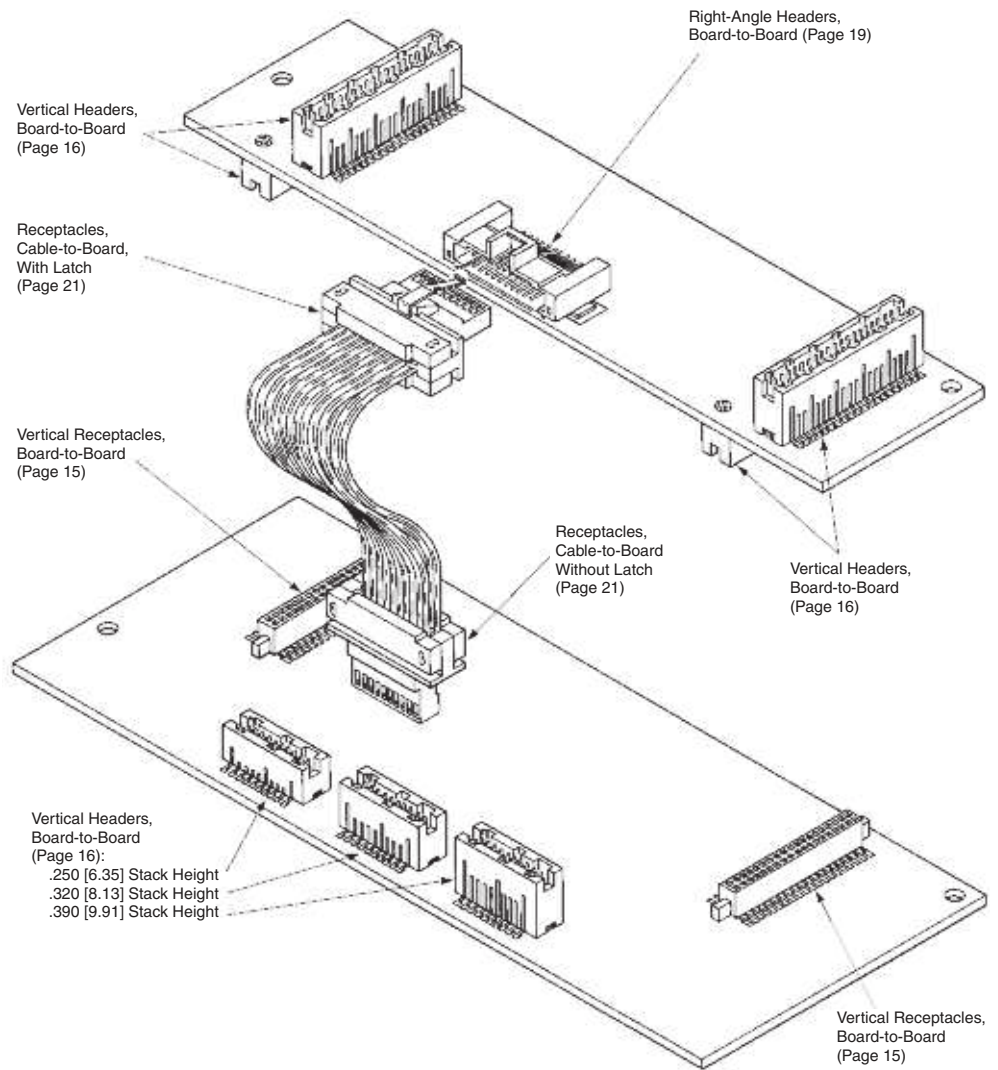

Produced under a Quality Management System certified to ISO 9001

A copy of the certificate is available upon request.



Board-to-Board Vertical Receptacles and Headers

Product Facts

- Surface-mount products for parallel board-to-board applications, as well as right-angle board-to-board and cable-to-board applications
- High density .050 x .050 [1.27x1.27] centerline grid
- Three board-to-board stack heights: .250 [6.35], .320 [8.13] and .390 [9.91]
- Non-protrusive metallic holddowns
- Reliable dual beam receptacle contacts for redundant contact
- Duplex plated receptacle and post contacts; gold plated on mating areas, tin plated on tails
- Compatible with standard surface-mount processing (VPR and IR)
- Receptacle and header allow for drainage of processing fluids
- Tape and reel packaging available. Contact TE for details
- Polarized header and receptacle assemblies
- Sizes of 10, 20, 30, 40, 50, 60, 70, 80 and 100 positions
- Recognized under the Component Program of Underwriters Laboratories Inc., File No. E28476
- Certified by Canadian Standards Association File No. LR7189

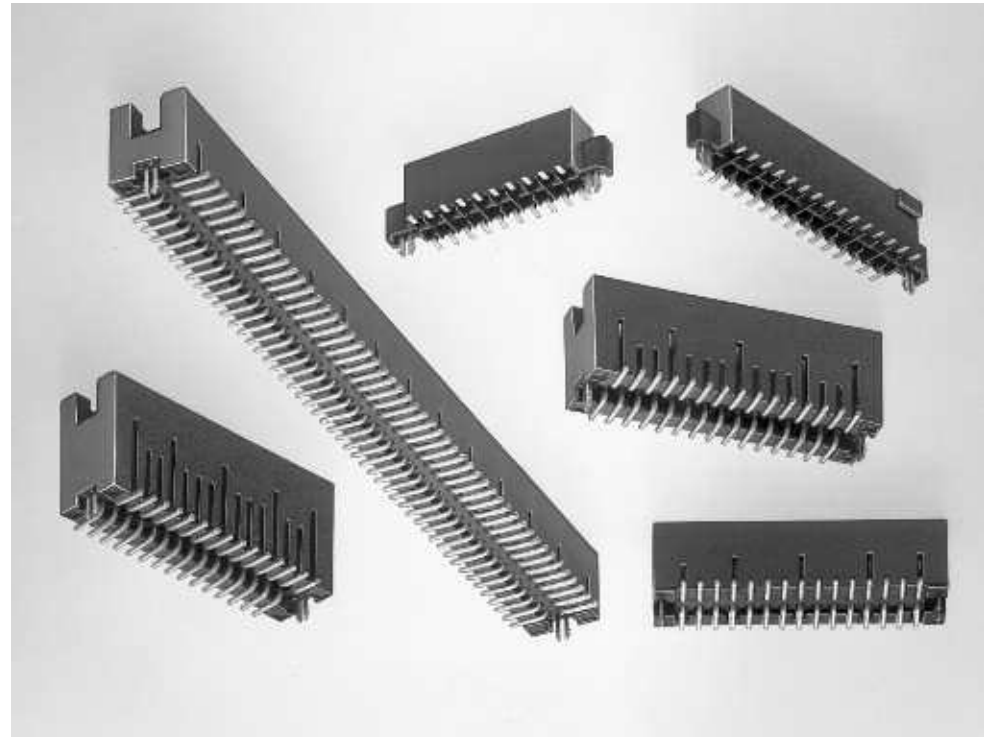

AMPMODU 50/50 Grid Vertical Headers and Receptacles are designed for parallel board-to-board stacking in high density applications.

Right-angle board-to-board and cable-to-board applications are also possible, since the vertical receptacles also mate with non-latching right-angle headers (page 19) and the vertical headers also mate with non-latching cable connectors.

Available are double row, vertical shrouded headers and receptacles in sizes ranging from 10 through 100 positions (in 10 position increments).

Parallel board-to-board stack heights of .250 [6.35], .320 [8.13] and .390 [9.91] are achievable by selection of the appropriate header. The receptacle is the same for all three stack height headers.

Non-protrusive metallic holddowns are designed for use in .062 [1.57] or thicker

PC boards and allow surface mounting to both sides of the board. In addition to providing retention during processing, the holddowns are soldered during reflow and therefore provide long-term strain relief for the solder joints.

AMPMODU 50/50 Grid Vertical Headers and Receptacles are designed to be compatible with standard surface-mount processes; IR (infrared) and VPR (vapor phase reflow). The surface-mount connectors have been designed so that dimensioning, tolerances, referenced datums, holddown characteristics

and packaging methods result in a system that is compatible with robotic assembly.

The headers and receptacles feature polarization to prevent misalignment.

Three Board Stack Heights

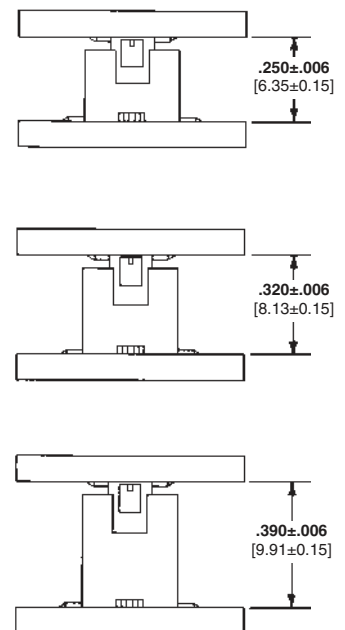

Non-Protrusive Metallic Holddowns

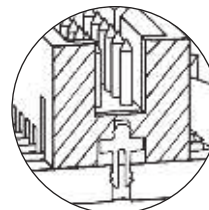

Board-to-Board Vertical Receptacles, Double Row, .050 x .050 [1.27 x 1.27] Centerline



Material and Finish

Housing—Glass-filled thermoplastic, black, 94V-0 rated

Contacts—Copper alloy; duplex plated .000030 [0.00076] gold in mating area, .000150 [0.00381] tin on solder tail, with entire contact underplated .000050 [0.00127] nickel

Holddown—Copper alloy; plated .000150 [0.00381] tin over .000050 [0.00127] nickel

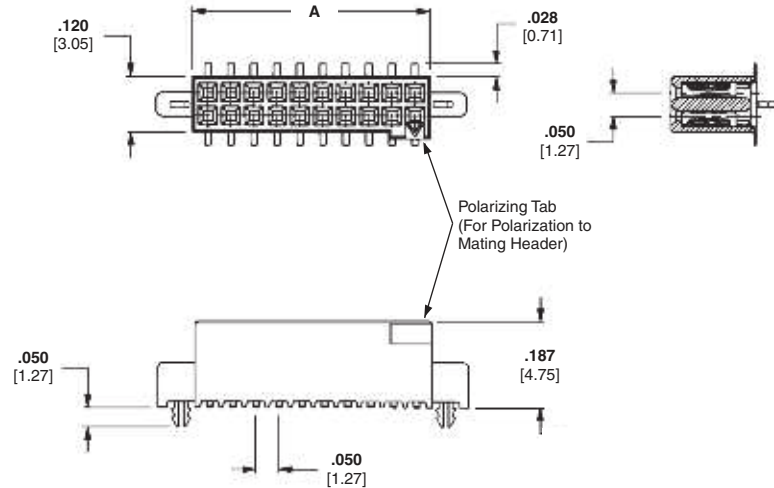

Related Product Data

Mating Headers — pages 16, 19

PC Board Layouts — page 17

Performance Specifications — page 24

Technical Documents — page 24

Product Specification 108-1332

Application Specification 114-7010

Packaging: Tube or Tape and Reel

| No. of Pos. | Dimension A | Receptacle Part Numbers | | |
|-------------|---------------|-------------------------|----------------|-----------------------------|
| | | Tube | Tape and Reel* | No Hold Down w/Vacuum Cover |
| 10 | .266 [6.75] | 5-104652-1 | 5-147384-1 | 5-147413-1 |
| 20 | .516 [13.11] | 5-104652-2 | 5-147384-2 | 5-147413-3 |
| 30 | .766 [19.46] | 5-104652-3 | 5-147384-3 | 5-147413-4 |
| 40 | 1.016 [25.81] | 5-104652-4 | 5-147384-4 | — |
| 50 | 1.266 [32.16] | 5-104652-5 | 5-147384-5 | 5-147413-2 |
| 60 | 1.516 [38.51] | 5-104652-6 | 5-147384-6 | — |
| 70 | 1.766 [44.86] | 5-104652-7 | 5-147384-7 | — |
| 80 | 2.016 [51.21] | 5-104652-8 | 5-147384-8 | — |
| 100 | 2.516 [63.91] | 6-104652-0 | 5-147384-9 | — |

* Parts packaged in tape and reel have vacuum pick and place cover. See PC Board Layout on page 17.

Note: All part numbers are RoHS compliant.

Board-to-Board Vertical Headers, Double Row, .050 x .050 [1.27 x 1.27] Centerline



For .250 [6.35] Mated Height



For .320 [8.13] Mated Height



For .390 [9.91] Mated Height

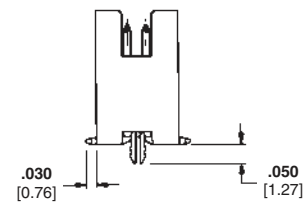
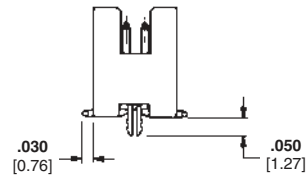
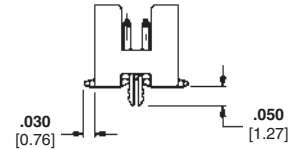
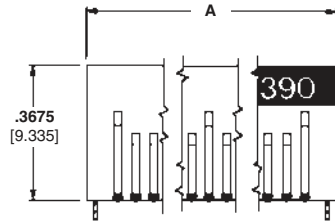
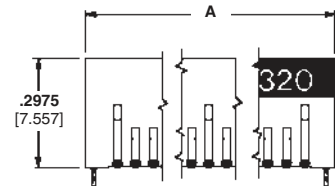
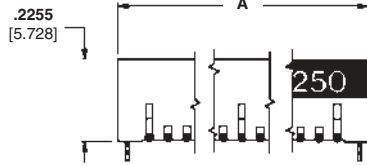
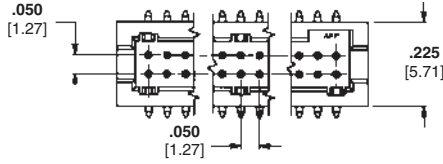

Material and Finish

Housing—Glass-filled thermoplastic, black, 94V-0 rated

Contacts—Copper alloy; duplex plated .000030 [0.00076] gold in mating area, .000150 [0.00381] tin on solder tail, with entire contact underplated .000050 [0.00127] nickel

Holddown—Copper alloy; plated .000150 [0.00381] tin over .000050 [0.00127] nickel

Related Product Data

Mating Receptacles — page 15, 21 (without latch only)

PC Board Layouts — page 17

Performance Specifications — page 24

Technical Documents — page 24

Product Specification 108-1332

Application Specification 114-7010

Packaging: Tube or Tape and Reel

| No. of Pos. | Dimension A | Header Part Numbers | | | | | | | | |
|-------------|---------------|--------------------------|--------------|------------|--------------------------|--------------|--------------------------|------------|--------------|--|
| | | .250 [6.35] Mated Height | | | .320 [8.13] Mated Height | | .390 [9.91] Mated Height | | | |
| | | Tubes | Tape & Reel* | | Tubes | Tape & Reel* | Tubes | | Tape & Reel* | |
| | | Hold Down | No Hold Down | | | Hold Down | No Hold Down | | | |
| 10 | .372 [9.44] | 5-104655-1 | 5-147381-1 | 5-147121-1 | 5-104656-1 | 5-147382-1 | 5-104693-1 | — | 5-147383-1 | |
| 20 | .622 [15.79] | 5-104655-3 | 5-147381-2 | 5-147121-2 | 5-104656-2 | 5-147382-2 | 5-104693-2 | — | 5-147383-2 | |
| 30 | .872 [22.14] | 5-104655-4 | 5-147381-3 | — | 5-104656-3 | 5-147382-3 | 5-104693-3 | — | 5-147383-3 | |
| 40 | 1.122 [28.49] | 5-104655-5 | 5-147381-4 | — | 5-104656-4 | 5-147382-4 | 5-104693-4 | — | 5-147383-4 | |
| 50 | 1.372 [34.84] | 5-104655-6 | 5-147381-5 | — | 5-104656-5 | 5-147382-5 | 5-104693-5 | — | 5-147383-5 | |
| 60 | 1.622 [41.19] | 5-104655-7 | 5-147381-6 | — | 5-104656-6 | 5-147382-6 | 5-104693-6 | — | 5-147383-6 | |
| 70 | 1.872 [47.54] | 5-104655-8 | 5-147381-7 | — | 5-104656-7 | 5-147382-7 | 5-104693-7 | — | 5-147383-7 | |
| 80 | 2.122 [53.89] | 5-104655-9 | 5-147381-8 | — | 5-104656-8 | 5-147382-8 | 5-104693-8 | — | 5-147383-8 | |
| 90 | 2.372 [60.24] | — | — | — | 5-104656-9 | — | 5-104693-9 | — | — | |
| 100 | 2.622 [66.59] | 6-104655-1 | 5-147381-9 | — | 6-104656-0 | 5-147382-9 | 6-104693-0 | 5-147503-1 | 5-147383-9 | |

*Parts packaged in tape and reel have vacuum pick and place cover. See PC Board Layout on page 17.

Note: All part numbers are RoHS compliant.

Vertical Headers, Double Row
2

Recommended PC Board Layouts for Vertical Connectors

Headers

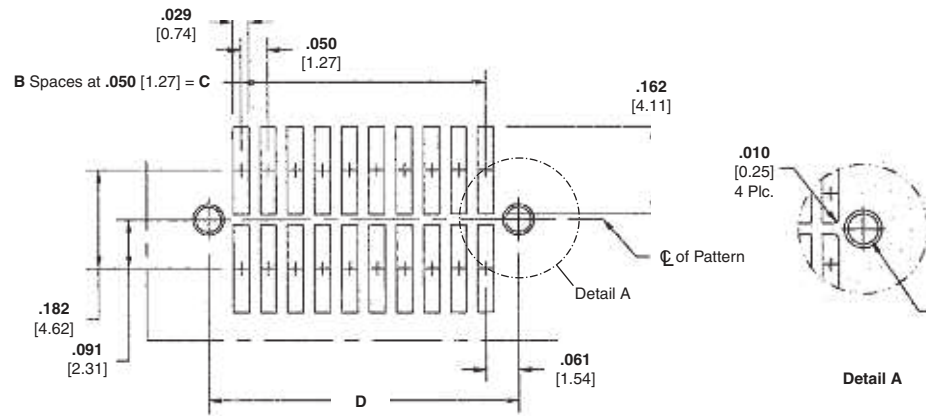

Receptacles

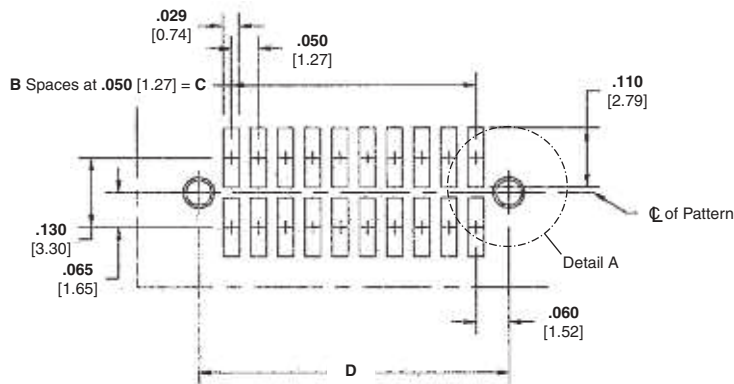



| No. of Pos. | Receptacle Dimensions | | | Header Dimensions | | |
|-------------|-----------------------|---------------|---------------|-------------------|---------------|---------------|
| | B | C | D | B | C | D |
| 10 | 4 | .200 [5.08] | .320 [8.12] | 4 | .200 [5.08] | .322 [8.17] |
| 20 | 9 | .450 [11.43] | .570 [14.48] | 9 | .450 [11.43] | .572 [14.52] |
| 30 | 14 | .700 [17.78] | .820 [20.83] | 14 | .700 [17.78] | .822 [20.87] |
| 40 | 19 | .950 [24.13] | 1.070 [27.19] | 19 | .950 [24.13] | 1.072 [27.22] |
| 50 | 24 | 1.200 [30.48] | 1.320 [33.53] | 24 | 1.200 [30.48] | 1.322 [33.57] |
| 60 | 29 | 1.450 [36.83] | 1.570 [39.88] | 29 | 1.450 [36.83] | 1.572 [39.92] |
| 70 | 34 | 1.700 [43.18] | 1.820 [46.23] | 34 | 1.700 [43.18] | 1.822 [46.27] |
| 80 | 39 | 1.950 [49.53] | 2.070 [52.58] | 39 | 1.950 [49.53] | 2.072 [52.62] |
| 90 | 44 | 2.200 [55.88] | 2.320 [58.93] | 44 | 2.200 [55.88] | 2.322 [58.97] |
| 100 | 49 | 2.450 [62.23] | 2.570 [65.28] | 49 | 2.450 [62.23] | 2.572 [65.32] |

Note: Refer to TE Customer Drawings for additional PC board layout information and dimensional tolerances.

Note: All part numbers are RoHS compliant.

Board-to-Board Right-Angle Headers

Product Facts

- Surface-mount products for right-angle board-to-board and cable-to-board applications
- Double-row, right-angle shrouded headers
- High density .050 x .050 [1.27 x 1.27] centerline grid
- Latching and non-latching versions available
- Non-protrusive metallic holddowns
- Metallic tabs, when soldered to PC board pad, provide added mechanical support
- Duplex plated post contacts; gold plated on mating area, tin plated on tails
- Compatible with standard surface-mount processing (VPR and IR)
- Standoffs on header housings allow for drainage of processing fluids
- All headers are polarized
- Sizes of 10, 20, 30, 40, 50, 60, 70, 80 and 100 positions
- Recognized under the Component Program of Underwriters Laboratories Inc., File No. E28476 
- Certified by Canadian Standards Association File No. LR7189 

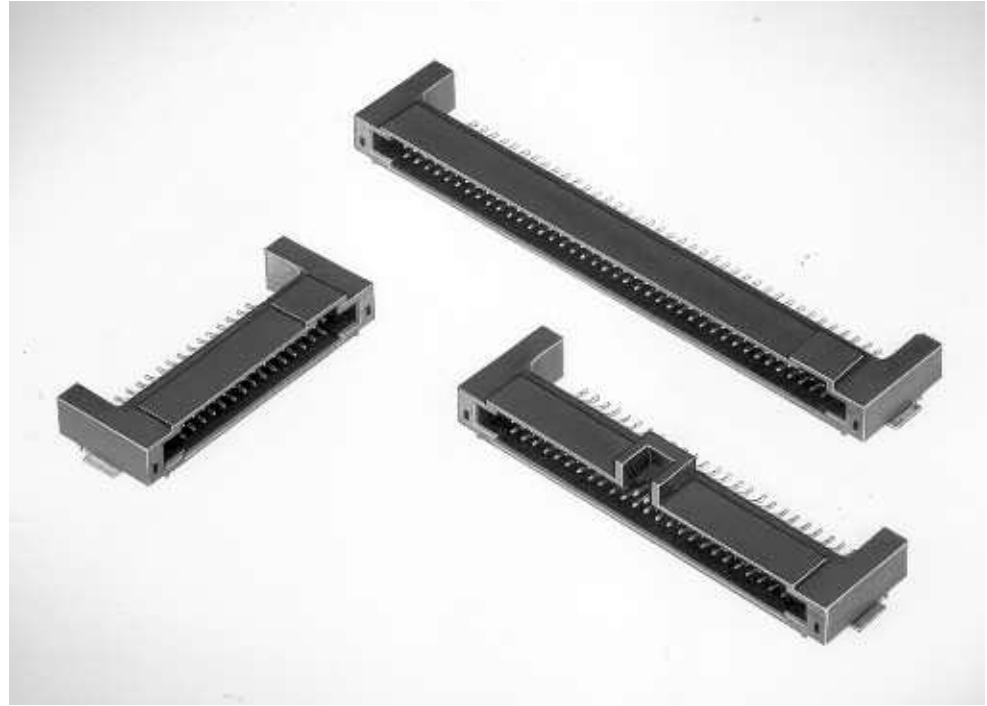

AMPMODU 50/50 Grid Right-Angle Headers will accommodate a variety of high density packaging applications; right-angle board-to-board applications when mated with vertical receptacles (page 15) and right-angle cable-to-board applications when mated with cable connectors (page 21). The small .050 x .050 [1.27 x 1.27] centerline contact spacing allows efficient use of the PC board area.

Mechanical support of the headers to the PC board is provided by non-protrusive metallic holddowns designed for .062 [1.57] or thicker PC boards. These holddowns are of the same

design as those used in the vertical headers (page 16) and receptacles (page 15). There are also metallic tabs that are soldered to the surfaces of the PC board pads for added support.

AMPMODU 50/50 Grid Right-Angle Headers are available in double-row, in either latching or non-latching versions, and in sizes ranging from 10 through 100 positions (in 10 position increments). The latching version provides positive retention when mated with the latching cable connector (page 21). All headers feature polarization to help prevent misalignment during mating.

Board-to-Board Right-Angle Headers, Double Row, .050 x .050 [1.27 x 1.27] Centerline

Non-Latching Header

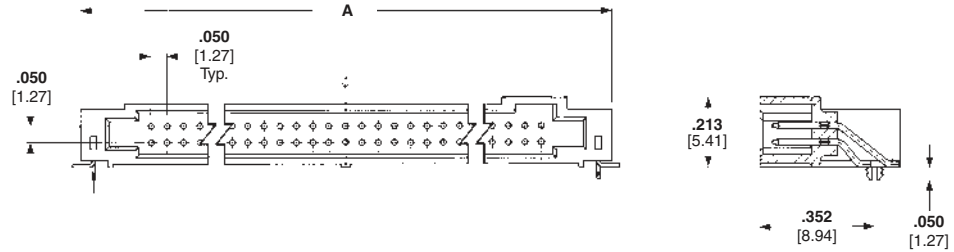

Latching Header

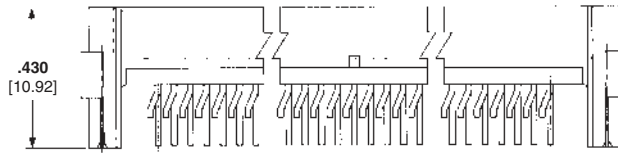
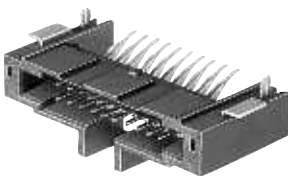

Material and Finish

Housing — Liquid crystal polymer, black, 94V-0 rated

Contacts — Copper alloy; duplex plated .000030 [0.00076] gold in mating area, .000150 [0.000381] tin on solder tail, with entire contact under-plated .000050 [0.00127] nickel

Holddown — Copper alloy; plated .0000150 [0.00381] tin over .000050 [0.00127] nickel

Related Product Data

Mating Receptacles — page 15, 21

Performance Specifications — page 24

Technical Documents — page 24

Product Specification 108-1443

Application Specification 114-7010

Packaging: Tube

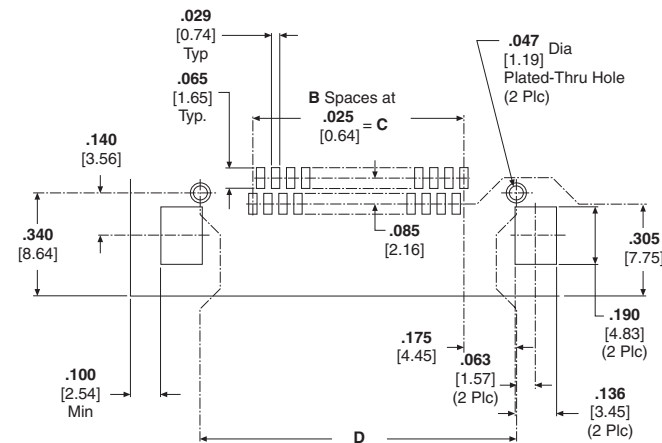

Recommended PC Board Layout



Note: Refer to TE Customer Drawings for additional PC board layout information and dimensional tolerances.

| No. of Pos. | Dimensions | | | | Header Part Numbers | |
|-------------|---------------|----|---------------|---------------|---------------------|--------------|
| | A | B | C | D | Latching | Non-Latching |
| 10 | .630 [16.00] | 9 | .225 [5.72] | .550 [13.97] | 5-104895-1 | 5-104894-1 |
| 20 | .880 [22.35] | 19 | .475 [12.07] | .800 [20.32] | 5-104895-2 | 5-104894-2 |
| 30 | 1.130 [28.70] | 29 | .725 [18.42] | 1.050 [26.67] | 5-104895-3 | 5-104894-3 |
| 40 | 1.380 [35.05] | 39 | .975 [24.77] | 1.300 [33.02] | 5-104895-4 | 5-104894-4 |
| 50 | 1.630 [41.40] | 49 | 1.225 [31.12] | 1.550 [39.37] | 5-104895-5 | 5-104894-5 |
| 60 | 1.880 [47.75] | 59 | 1.475 [37.47] | 1.800 [45.72] | 5-104895-6 | 5-104894-6 |
| 70 | 2.130 [54.10] | 69 | 1.725 [43.82] | 2.050 [52.07] | 5-104895-7 | 5-104894-7 |
| 80 | 2.380 [60.45] | 79 | 1.975 [50.17] | 2.300 [58.42] | 5-104895-8 | 5-104894-8 |
| 100 | 2.880 [73.15] | 99 | 2.475 [62.87] | 2.800 [71.12] | 6-104895-0 | 6-104894-0 |

Note: All part numbers are RoHS compliant.

Cable-to-Board Connectors

Product Facts

- Double-row receptacle connectors provide cable-to-board connection capabilities for vertical headers (non-latching) and right-angle headers (latching and non-latching)
- IDC (Insulation Displacement Crimp) mass termination of solid or stranded round conductor .050 [1.27] centerline ribbon cable with PVC or polyethylene insulation
- Accommodates ribbon cable conductor sizes of 28 AWG [0.08-0.09 mm²] and 30 AWG [0.05 mm²] and insulation diameters up to .036 [0.91] maximum
- Reliable single beam receptacle contact design
- Duplex plated receptacle contacts; gold plated in mating area, tin in termination area
- Terminating covers (sold separately) provide both strain relief and protection to the termination area
- Sizes of 10, 20, 30, 40, 50, 60, 70, 80 and 100 positions
- Connectors available with or without metal latch
- Connectors without latches are polarized to help prevent mismatching
- Recognized under the Component Program of Underwriters Laboratories Inc.,  File No. E28476
- Certified by Canadian Standards Association  File No. LR7189

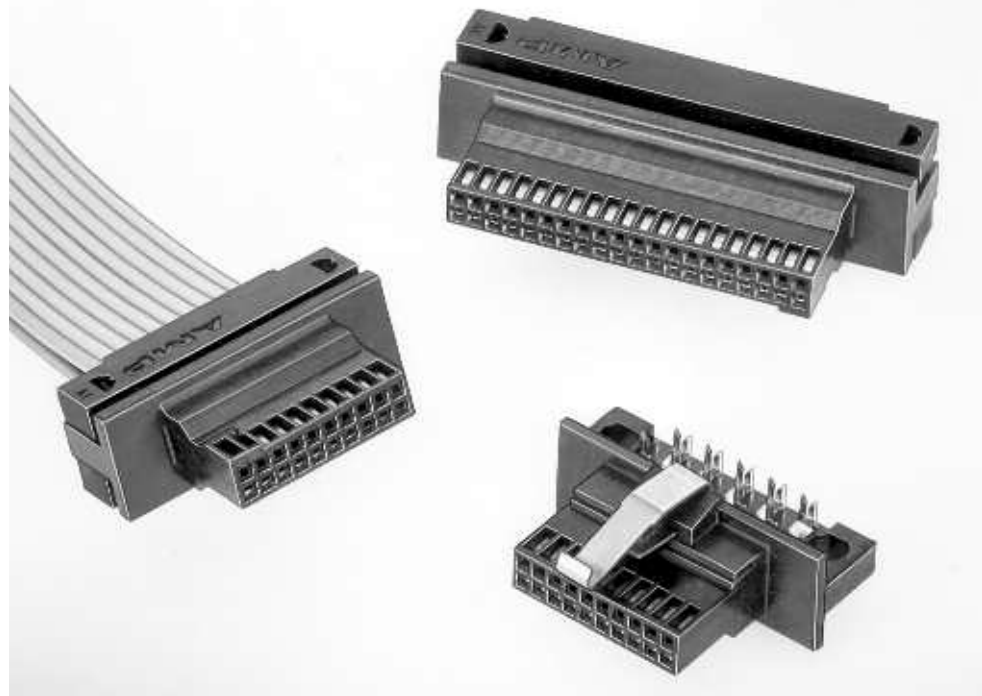

These double-row cable connectors, with a .050 x .050 [1.27 x 1.27] centerline contact spacing, provide cable-to-board connection capabilities for the AMPMODU 50/50 Grid Connector System. Cable connectors without a latch will mate with the vertical headers (page 16), while cable connectors with or without a latch can be used to mate with the right-angle headers (page 19).

The cable connectors feature reliable single-beam IDC (insulation displacement crimp) contacts which are duplex plated with .000030 [0.00076] gold. These contacts can be mass terminated to either solid or

stranded round conductor ribbon cable with conductor sizes of 28 AWG [0.08-0.09 mm²] and 30 AWG [0.05 mm²] and a maximum insulation diameter of .036 [0.91]. During termination, the terminating covers, which must be purchased separately, assist in guiding the wire into the IDC contacts, then provide strain relief when fully seated. Actual termination is accomplished with the TE manual tooling shown on page 23.

The latching version of the cable connector is equipped with a metal latch which provides positive retention of the receptacle cable connector when mated with a surface-

mounted right-angle header. The cable connector without a metal latch features polarization to help prevent mismatching. All connectors are available in sizes ranging from 10 through 100 positions (in 10 position increments).

Cable-to-Board Receptacle Connectors, Double Row, .050 x .050 [1.27 x 1.27] Centerline

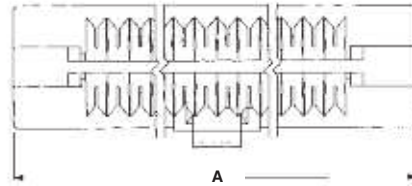
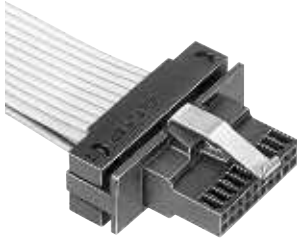

Material and Finish

Housing — Thermoplastic, black, 94V-0 rated

Latch — Stainless steel

Contacts — Phosphor bronze; duplex plated .000030 [0.00076] minimum gold in mating area, .000150 [0.00381] minimum tin on solder tail, with entire contact underplated .000050 [0.00127] minimum nickel

Related Product Data

Mating Headers — page 16, 19 (latching)

Terminating Covers (Must be Purchased Separately, 2 Required per Connector) — page 22

Termination Tooling — page 23

Performance Specifications — page 24

Technical Documents — page 24

Product Specification 108-1443

Application Specification
408-9817, 408-9909

Packaging: Tube

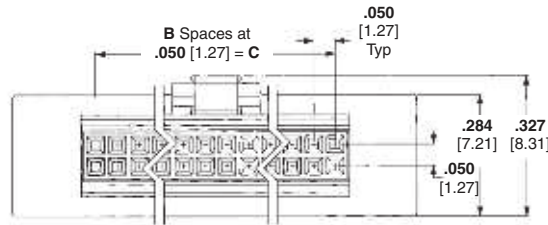
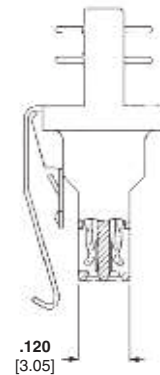
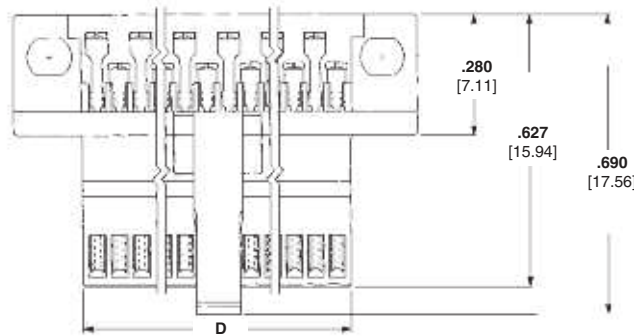

| No. of Pos. | Dimensions | | | | Receptacle Part Numbers | |
|-------------|---------------|----|---------------|---------------|-------------------------|---------------|
| | A | B | C | D | With Latch | Without Latch |
| 10 | .578 [14.68] | 4 | .200 [5.08] | .266 [6.76] | 5-104892-1 | 5-104893-1 |
| 20 | .828 [21.03] | 9 | .450 [11.43] | .516 [13.11] | 5-104892-2 | 5-104893-2 |
| 30 | 1.078 [27.38] | 14 | .700 [17.78] | .766 [19.46] | 5-104892-3 | 5-104893-3 |
| 40 | 1.328 [33.73] | 19 | .950 [24.13] | 1.016 [25.81] | 5-104892-4 | 5-104893-4 |
| 50 | 1.578 [40.08] | 24 | 1.200 [30.48] | 1.266 [32.16] | 5-104892-5 | 5-104893-5 |
| 60 | 1.828 [46.43] | 29 | 1.450 [36.83] | 1.516 [38.51] | 5-104892-6 | 5-104893-6 |
| 70 | 2.078 [52.78] | 34 | 1.700 [43.18] | 1.766 [44.86] | 5-104892-7 | 5-104893-7 |
| 80 | 2.328 [59.13] | 39 | 1.950 [49.53] | 2.016 [51.21] | 5-104892-8 | 5-104893-8 |
| 100 | 2.828 [71.83] | 49 | 2.450 [62.23] | 2.516 [63.91] | 6-104892-0 | 6-104893-0 |

Note: All part numbers are RoHS compliant.

Terminating Covers for Cable Connectors



Cable Connector Terminating Cover, Double Row

Material

Glass-filled thermoplastic, black, 94V-0 rated

Related Product Data

Connectors used with Covers — page 21

Termination Tooling — page 23

Technical Documents — page 24

Product Specification 108-1443

Application Specification 408-9817, 408-9909

Packaging: Plastic bag

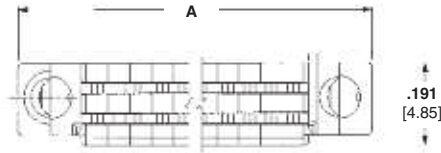

| No. of Pos. | Dimension A | Terminator Cover Part Numbers |
|-------------|---------------|-------------------------------|
| 10 | .565 [14.35] | 104891-1 |
| 20 | .815 [20.70] | 104891-2 |
| 30 | 1.065 [27.05] | 104891-3 |
| 40 | 1.315 [33.82] | 104891-4 |
| 50 | 1.565 [39.75] | 104891-5 |
| 60 | 1.815 [46.10] | 104891-6 |
| 70 | 2.065 [52.45] | 104891-7 |
| 80 | 2.315 [58.80] | 104891-8 |
| 100 | 2.815 [71.50] | 1-104891-0 |

Note: Terminating covers must be purchased separately, two are required for each cable connector.

Note: All part numbers are RoHS compliant.

Application Tooling for Cable Connectors

The Manual Miniature Application Frame Assembly 91295-1, equipped with a Cover Closing Kit 543518-1, is used for the IDC termination of ribbon cable to the cable connectors shown on page 21.

Prior to termination, the covers must be partially assembled onto a connector housing, the cable inserted between the covers and contacts and the covers preclosed by hand, clamping the cable in place.

In the Manual Miniature Application Frame Assembly, the covers are fully seated to complete the mass termination and provide strain relief for the completed connection.



Manual Miniature Application Frame Assembly 91295-1
with Cover Closing Kit 543518-1

For tooling information, call Technical Support Center **1-800-522-6752**.

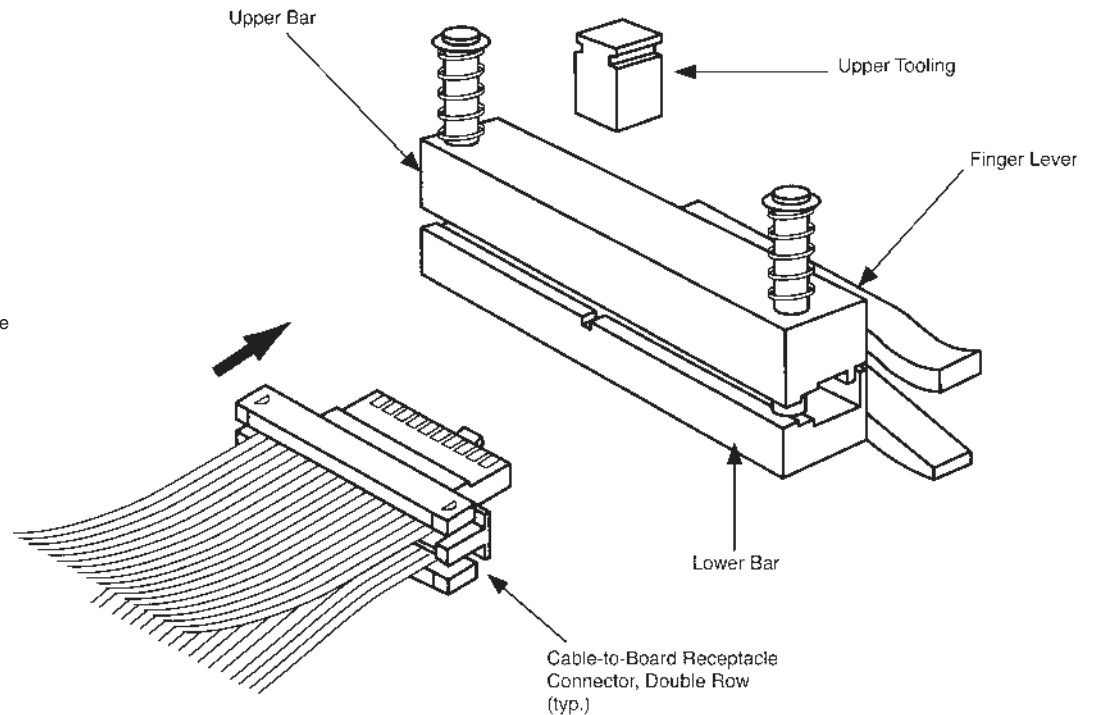

Note: Refer to Tyco Electronics Instruction Sheets 408-9817 (Frame Assembly 91295-1) and 408-9909 (Cover Closing Kit 543518-1) for complete termination/tooling information.

Note: All part numbers are RoHS compliant.

Performance Specifications

Board-to-Board Connectors, Vertical and Right-Angle

Mating Force: 6.4 oz (1.78 N) max. per contact

Unmating Force: 1.0 oz [0.28 N] min. per contact

Durability: Tested to 200 cycles min.

Current Rating: (30°C T rise): .5 ampere per contact

Operating Temperature Range: -65°C to +105°C

Termination Resistance: 16 milliohms max. (initial)

Insulation Resistance: 5000 megohms min. (initial)

Dielectric Withstanding Voltage: 300 VAC

Cable-to-Board Connectors

Mating Force: 6.4 oz (1.78 N) max. per contact

Unmating Force Without Latch: .5 oz [0.14 N] min. per contact

Durability: Tested to 200 cycles min.

Current Rating: (10°C T rise): .5 ampere per contact

Operating Temperature Range: -65°C to +105°C

Termination Resistance: 25 milliohms max. (initial and final)

Insulation Resistance: 5000 megohms min. (initial)

Dielectric Withstanding Voltage: 300 VAC

Technical Documents

Various technical documents are available for your use:

Product Specifications describe technical performance characteristics and verification tests. They are intended for the Design, Component and Quality Engineer.

108-1332 AMPMODU 50/50 Grid Vertical Board-to-Board Connectors

108-1443 AMPMODU 50/50 Grid Right-Angle Board-to-Board and Cable Connectors

Application Specifications describe requirements for using the product in its intended application and/or crimping information. They are intended for the Packaging and Design Engineer and the Machine Setup Person.

114-7010 AMPMODU 50/50 Grid Connector System

Instruction Sheets provide instructions for assembling or applying the product. They are intended for the Manufacturing Assembler or Operator.

408-9817 Manual Miniature Application Frame Assembly 91295-1

408-9909 Cover Closing Kit 543518-1

Note: All part numbers are RoHS compliant.

AMPMODU System 50 Connectors

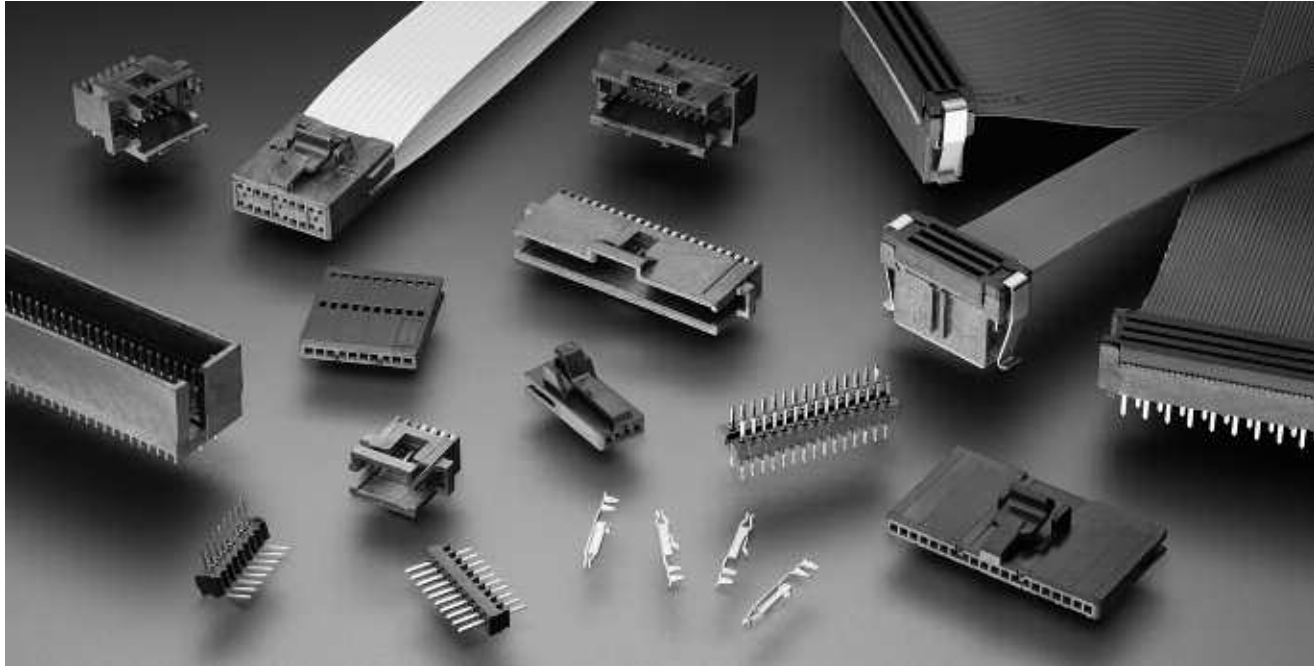

The AMPMODU System 50 connector family includes a wide variety of high density board-to-board (thru-hole and surface-mount) and cable-to-board connectors. AMPMODU System 50 is composed of one- and two-row receptacles and post headers on .050 x .100 [1.27 x 2.54] spacing between contacts for extreme density and efficient use of printed circuit board area.

AMPMODU System 50 receptacles and header assemblies can be categorized in three groups: board-mount headers, board-mount receptacles and cable-to-board receptacles. Receptacle contacts and mating .015 [0.38] square posts are formed from high conductivity copper alloy and are selectively plated with gold to promote higher performance and reliability.

Board-mounted thru-hole post headers and receptacle connectors are available for right-angle and vertical mating configurations. Surface-mounted connectors are available in vertical, double row styles for parallel stacking applications. Shrouded post headers provide polarization to mating cable receptacles and aid alignment of mating connectors. Unshrouded headers allow close stacking of daughter cards. Vertical stacking connectors space parallel mated boards as shown in the illustration on page 63. Housings on all board-mount assemblies are made of high temperature tolerant materials and incorporate stand-offs for free drainage of flux cleaning solutions.

Cable-to-board connectors have integral latches for positive locking to shrouded

mating headers (thru-hole or surface-mount). Ribbon cable connectors mass terminate 30 AWG [0.05 mm²] solid and 32 AWG [0.03 mm²] stranded, .025 [0.64] centerline ribbon cable with PVC insulation.

Connectors for mass termination to FFC cable or flexible etched circuitry have dual beam contacts; options include shielded cable and solder tabs. Both types of cable connectors are available as component parts and as completed assemblies.

The variety of components and application possibilities, combined with small size and outstanding quality, make AMPMODU System 50 suitable for high density systems.

■ **Recognized under the Component Program of Underwriters Laboratories Inc.** File No. E28476



■ **Certified by Canadian Standards Association*,** File No. LR 7189

*CSA certification pending on certain products, as noted.



Dimensioning:

Dimensions are in inches and millimeters. Values in brackets are metric equivalents. Metric symbols used are:

- mm (millimeter)
- cm (centimeter)
- m (meter)
- mm² (square millimeter)
- C (Celsius)
- N (newton)
- kg (kilogram)

■ **Produced under a Quality Management System certified to ISO 9001**

A copy of the certificate is available upon request.



Thru-Hole Headers—Shrouded, .050 x .100 [1.27 x 2.54] Centerline, Board-to-Board

Product Facts

- High density; contacts spaced on .050 x .100 [1.27 x 2.54] centers
- Single row; select sizes 4 thru 50 positions
- Double row; select sizes 10 thru 100 positions
- Stand-offs for ease of cleaning
- High temperature tolerant thermoplastic housings
- Shrouded and unshrouded headers available in single and double row, vertical and right-angle configurations

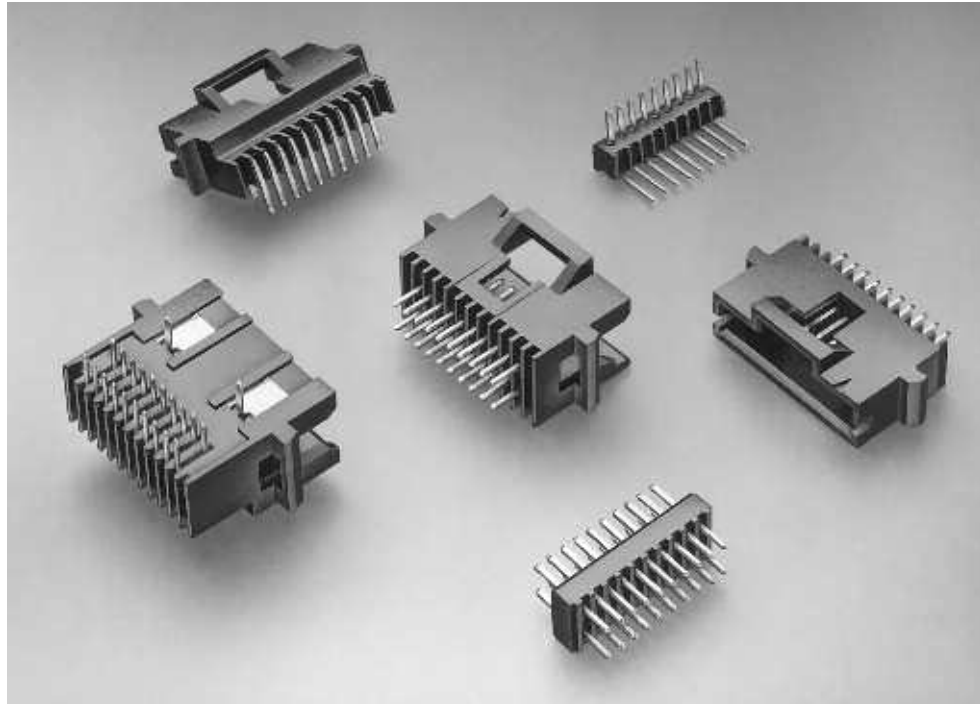

The AMPMODU System 50 interconnection system is designed to better meet industry's need for a high density interconnect system. The Board Mounted Thru-Hole Headers are available in shrouded and unshrouded versions. They are composed of single and double row post headers with .050 x .100 [1.27 x 2.54] spacing between contacts for extreme density and

efficient use of printed circuit board area. The headers are available in 4 through 50 positions, in a single row configuration, and 10 through 100 positions, in a double row design.

Board mounted post headers are available in right-angle and vertical configurations. Shrouded post headers provide polarization and alignment features for mating printed

circuit boards and cable connectors, while unshrouded headers allow close stacking of daughter cards. Housings for the headers are made of black thermoplastic material with a 94V-0 rating. The housings have stand-offs for free drainage of flux cleaning solutions.

Thru-Hole Headers—Shrouded, .050 x .100 [1.27 x 2.54] Centerline, Board-to-Board (Continued)

Single Row, Right-Angle with Solder Clips

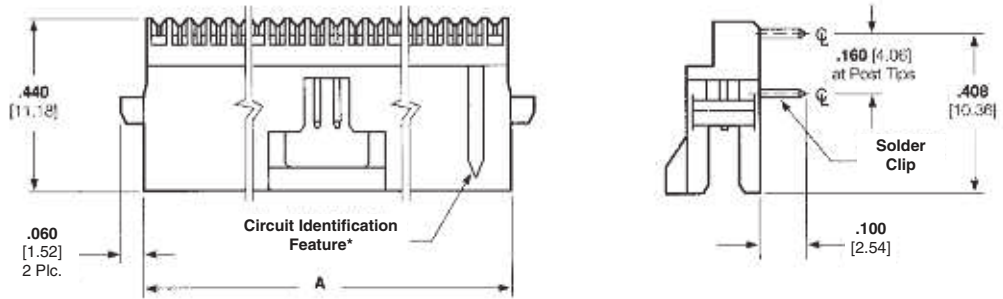

Material and Finish

Housing — Glass-filled thermoplastic, black, 94V-0 rated

Contacts — Copper alloy; duplex plated .000030 [0.00076] gold in mating area, .000150 [0.00381] tin on solder posts, with entire contact underplated .000050 [0.00127] nickel

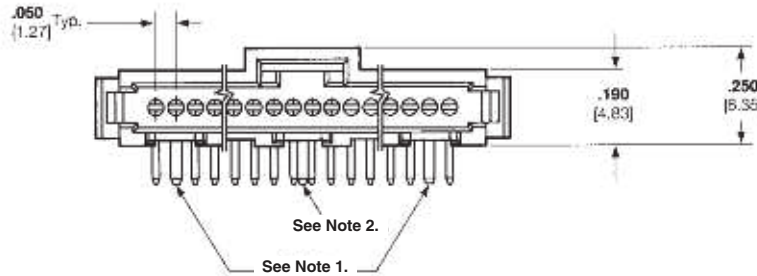

Related Product Data

Performance Characteristics — page 63

Mateable Connectors — pages 38, 49 & 50

PC Board Hole Layout — page 41

Technical Documents — page 64

Product Specification 108-1093

Application Specification 114-25031

| No. of Pos. | Dimension A | Part Numbers |
|-------------|---------------|--------------|
| 4 | .330 [8.38] | 5-104074-7 |
| 5 | .380 [9.65] | 5-104074-2 |
| 6 | .430 [10.92] | 5-104074-8 |
| 8 | .530 [13.46] | 6-104074-0 |
| 10 | .630 [16.00] | 5-104074-1 |
| 12 | .730 [18.54] | 6-104074-1 |
| 15 | .880 [22.35] | 5-104074-3 |
| 20 | 1.130 [28.70] | 5-104074-4 |
| 22 | 1.230 [31.24] | 6-104074-4 |
| 25 | 1.380 [35.05] | 5-104074-5 |
| 28 | 1.530 [38.86] | 7-104074-0 |
| 30 | 1.630 [41.40] | 5-104074-6 |
| 36 | 1.930 [49.02] | 6-104074-6 |
| 40 | 2.130 [54.10] | 6-104074-7 |
| 45 | 2.380 [60.45] | 6-104074-8 |
| 50 | 2.630 [66.80] | 6-104074-9 |

*Circuit identification feature omitted on 4, 5 and 6 position headers.

Notes:

1. Solder Clips located as shown for 10 through 30 position headers.
2. Solder Clips located as shown for 4 through 8 and 36 through 50 position headers.

Note: All part numbers are RoHS compliant.

Thru-Hole Headers—Shrouded, .050 x .100 [1.27 x 2.54] Centerline, Board-to-Board (Continued)

Single Row, Vertical

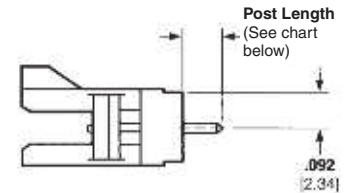
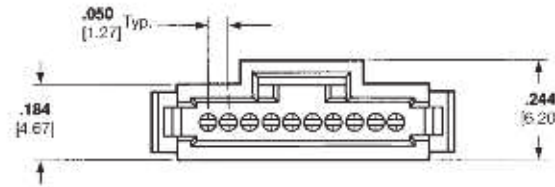
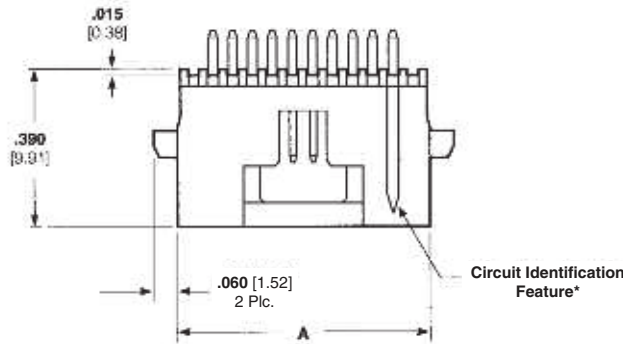
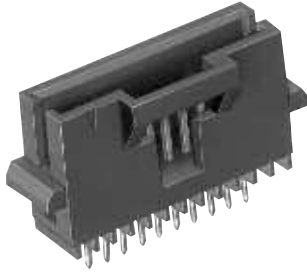

Material and Finish

Housing — Glass-filled thermoplastic, black, 94V-0 rated

Contacts — Copper alloy; duplex plated .000030 [0.00076] gold in mating area, .000150 [0.00381] tin on solder posts, with entire contact underplated .00050 [0.00127] nickel

Related Product Data

Performance Characteristics — page 63

Mateable Connectors — pages 38, 49 & 50

Board-to-Board Spacing — page 63

PC Board Hole Layout — page 41

Technical Documents — page 64

Product Specification 108-1093

Application Specification 114-25031

| No. of Pos. | Dimension A | Part Numbers | |
|-------------|---------------|--------------|-------------|
| | | Post Length | |
| | | .100 [2.54] | .145 [3.68] |
| 4 | .330 [8.38] | 5-104071-7 | — |
| 5 | .380 [9.65] | 5-104071-2 | — |
| 6 | .430 [10.92] | 5-104071-8 | — |
| 8 | .530 [13.46] | 6-104071-0 | — |
| 10 | .630 [16.00] | 5-104071-1 | — |
| 12 | .730 [18.54] | 6-104071-1 | 5-104804-3 |
| 13 | .780 [19.81] | 6-104071-2 | — |
| 15 | .880 [22.35] | 5-104071-3 | 5-104804-2 |
| 17 | .980 [24.89] | 6-104071-3 | — |
| 20 | 1.130 [28.70] | 5-104071-4 | — |
| 22 | 1.230 [31.24] | 6-104071-4 | — |
| 25 | 1.380 [35.05] | 5-104071-5 | — |
| 30 | 1.630 [41.40] | 5-104071-6 | — |
| 36 | 1.930 [49.02] | 6-104071-6 | — |
| 40 | 2.130 [54.10] | 6-104071-7 | — |
| 50 | 2.630 [66.80] | 6-104071-9 | — |

*Circuit identification feature omitted on 4, 5, and 6 position headers.

Note: All part numbers are RoHS compliant.

Thru-Hole Headers—Shrouded, .050 x .100 [1.27 x 2.54] Centerline, Board-to-Board (Continued)

Double Row, Right-Angle with Solder Clips

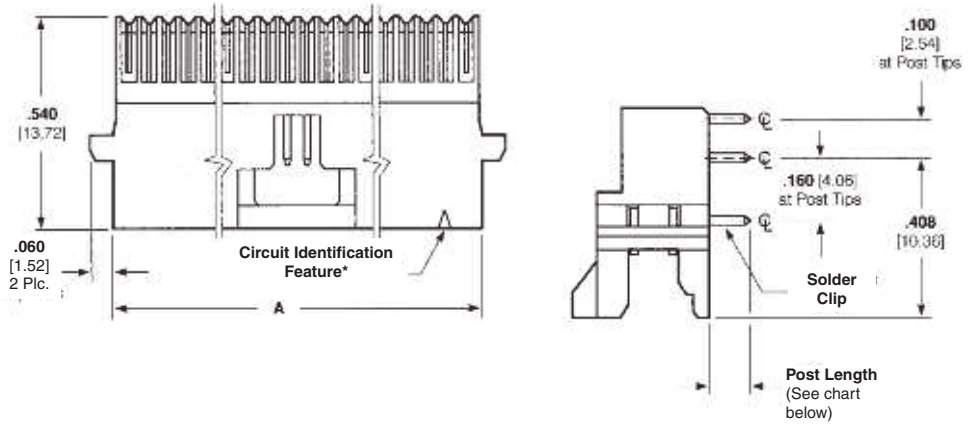
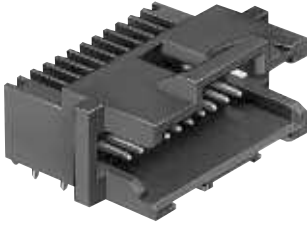

Material and Finish

Housing — Glass-filled thermoplastic, black, 94V-0 rated

Contacts — Copper alloy; duplex plated .000030 [0.00076] gold in mating area, .000150 [0.00381] tin on solder posts, with entire contact underplated .000050 [0.00127] nickel

Related Product Data

Performance Characteristics — page 63

Mateable Connectors — pages 40, 45, 51, 52, & 56

PC Board Hole Layout — page 41

Technical Documents — page 64

Product Specification 108-1093

Application Specification 114-25031

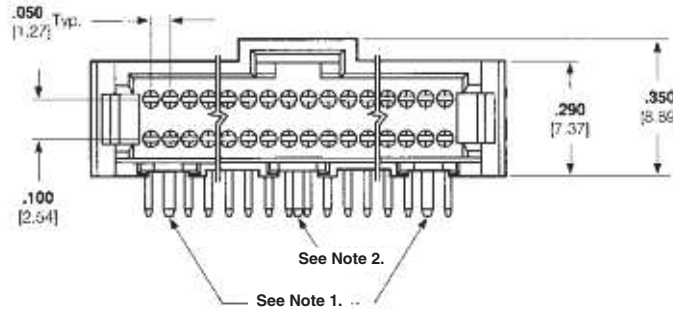

| No. of Pos. | Dimension A | Part Numbers | |
|-------------|---------------|--------------|-------------|
| | | Post Length | |
| | | .100 [2.54] | .145 [3.68] |
| 8 | .330 [8.32] | 5-104069-8 | — |
| 10 | .380 [9.65] | 5-104069-4 | 6-104477-2 |
| 12 | .430 [10.92] | — | 5-104477-8 |
| 14 | .480 [12.19] | 6-104069-0 | — |
| 16 | .530 [13.46] | 6-104069-1 | — |
| 20 | .630 [16.00] | 5-104069-1 | 5-104477-2 |
| 24 | .730 [18.54] | 6-104069-2 | 6-104477-0 |
| 26 | .780 [19.81] | 6-104069-3 | — |
| 30 | .880 [22.35] | 5-104069-5 | 5-104477-3 |
| 34 | .980 [24.89] | 6-104069-4 | — |
| 40 | 1.130 [28.70] | 5-104069-6 | 5-104477-4 |
| 50 | 1.380 [35.05] | 5-104069-2 | 5-104477-5 |
| 60 | 1.630 [41.40] | 5-104069-7 | 5-104477-9 |
| 68 | 1.830 [46.48] | 6-104069-8 | — |
| 72 | 1.930 [49.02] | 6-104069-6 | 5-104477-1 |
| 80 | 2.130 [54.10] | 5-104069-3 | 5-104477-6 |
| 100 | 2.630 [66.80] | 6-104069-7 | 5-104477-7 |

*Circuit identification feature omitted on 8, 10 and 12 position headers.

Notes:

1. Solder Clips located as shown for 16 through 100 position headers.
2. Solder Clips located as shown for 8 through 12 and 60 through 100 position headers.

Note: All part numbers are RoHS compliant.

Thru-Hole Headers—Shrouded, .050 x .100 [1.27 x 2.54] Centerline, Board-to-Board (Continued)

Double Row, Vertical

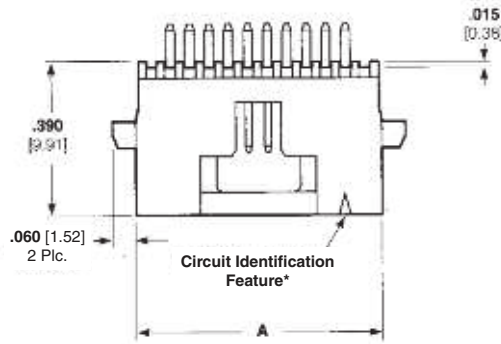
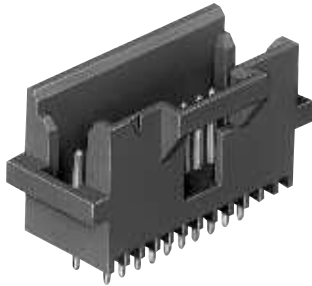

Material and Finish

Housing — Glass-filled thermoplastic, black, 94V-0 rated

Contact — Copper alloy; duplex plated .000030 [0.00076] gold in mating area, .000150 [0.00381] tin on solder posts, with entire contact underplated .000050 [0.00127] nickel

Related Product Data

Performance Specifications — page 63

Mateable Connectors — pages 40, 45, 51, 52, & 56

Board-to-Board Spacing — page 63

PC Board Hole Layout — page 41

Technical Documents — page 64

Product Specification 108-1093

Application Specification 114-25031

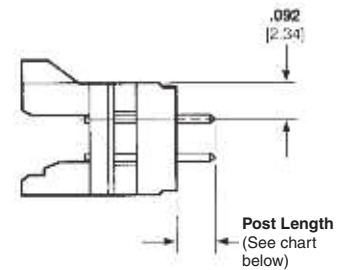
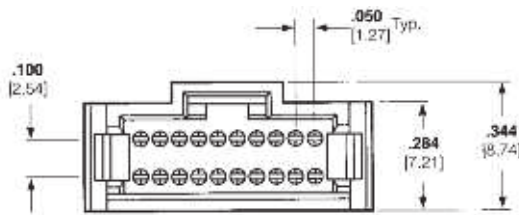

| No. of Pos. | Dimension A | Part Numbers | |
|-------------|---------------|--------------|-------------|
| | | Post Length | |
| | | .100 [2.54] | .145 [3.68] |
| 10 | .380 [9.65] | 5-104068-2 | — |
| 12 | .430 [10.92] | 5-104068-8 | — |
| 14 | .480 [12.19] | 5-104068-9 | — |
| 16 | .530 [13.46] | 6-104068-0 | 5-104666-9 |
| 20 | .630 [16.00] | 5-104068-1 | 5-104666-1 |
| 24 | .730 [18.54] | 6-104068-1 | 6-104666-0 |
| 26 | .780 [19.81] | 6-104068-2 | — |
| 30 | .880 [22.35] | 5-104068-3 | 5-104666-2 |
| 34 | .980 [24.89] | 6-104068-3 | — |
| 40 | 1.130 [28.70] | 5-104068-4 | 5-104666-3 |
| 44 | 1.230 [31.24] | 6-104068-4 | — |
| 50 | 1.380 [35.05] | 5-104068-5 | 5-104666-4 |
| 60 | 1.630 [41.40] | 5-104068-6 | 5-104666-7 |
| 68 | 1.830 [46.48] | 6-104068-8 | 5-104666-8 |
| 72 | 1.930 [49.02] | 6-104068-5 | — |
| 80 | 2.130 [54.10] | 6-104068-6 | 5-104666-5 |
| 100 | 2.630 [66.80] | 6-104068-7 | 5-104666-6 |

*Circuit identification feature omitted on 10 and 12 position headers.

Note: All part numbers are RoHS compliant.

Thru-Hole Headers—Shrouded, .050 x .100 [1.27 x 2.54] Centerline, Board-to-Board (Continued)

Double Row, Vertical With Card Slots

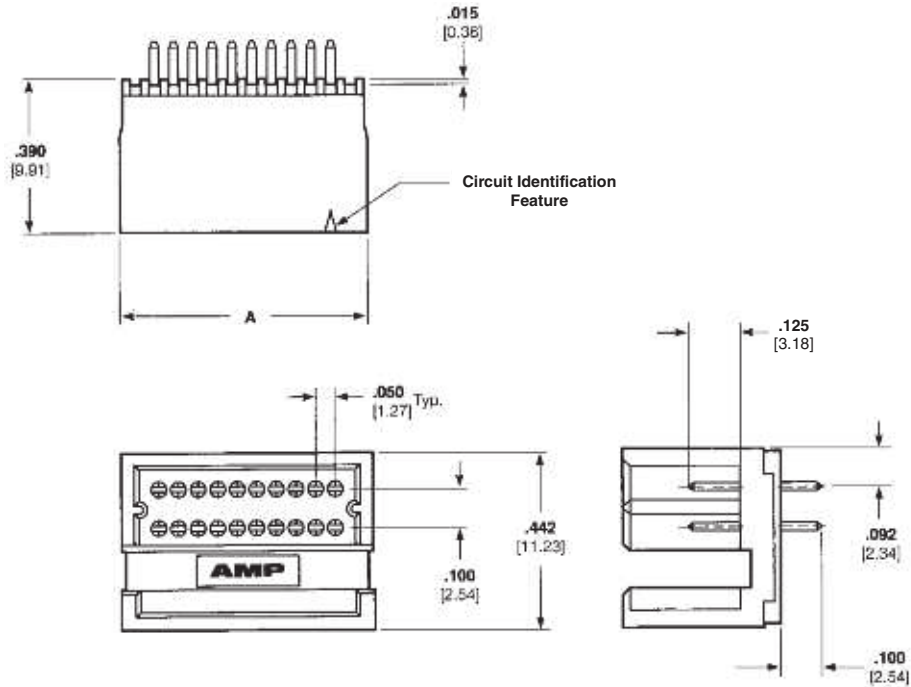
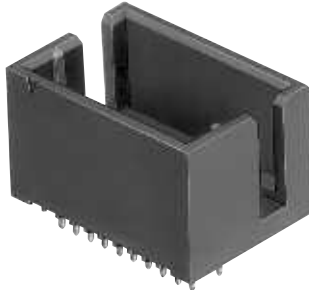

Material and Finish

Housing — Glass-filled thermoplastic, black, 94V-0 rated

Contacts — Copper alloy; duplex plated .000030 [0.00076] gold in mating area, .000150 [0.00381] tin on solder posts, with entire contact underplated .000050 [0.00127] nickel

Related Product Data

Performance Specifications — page 63

Mateable Connectors — page 39

PC Board Hole Layout — page 41

Technical Documents — page 64

Product Specification 108-1093

Application Specification 114-25031

| No. of Pos. | Dimension A | Part Numbers |
|-------------|---------------|--------------|
| 10 | .394 [10.01] | 5-104076-5 |
| 20 | .644 [16.36] | 5-104076-1 |
| 30 | .894 [22.71] | 5-104076-6 |
| 40 | 1.144 [29.06] | 5-104076-3 |
| 50 | 1.394 [35.41] | 5-104076-7 |
| 60 | 1.644 [41.76] | 5-104076-2 |
| 80 | 2.144 [54.46] | 5-104076-4 |
| 100 | 2.644 [67.16] | 5-104076-8 |

Note: All part numbers are RoHS compliant.

Thru-Hole Headers—Unshrouded, .050 x .100 [1.27 x 2.54] Centerline, Board-to-Board

Single Row, Right-Angle

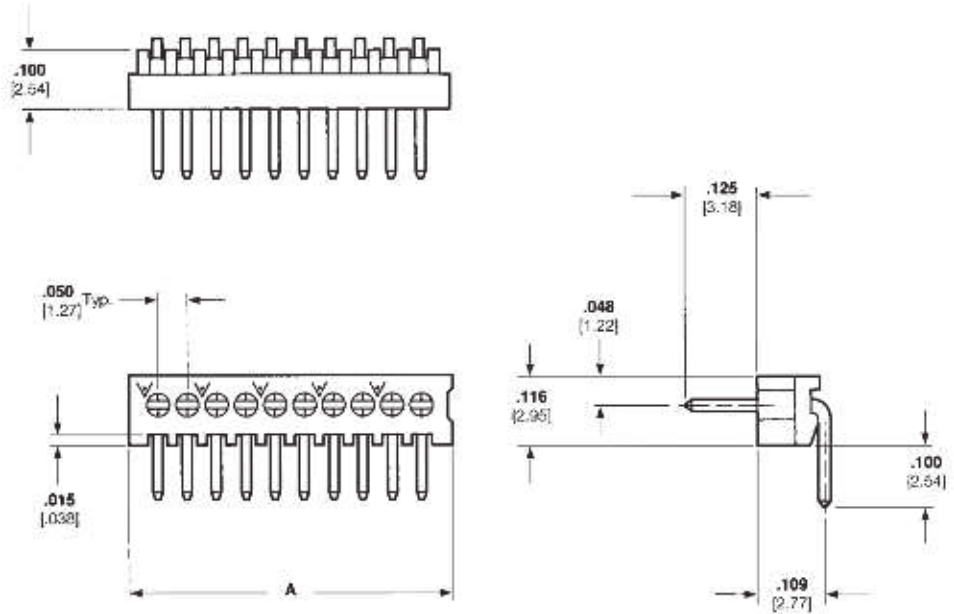
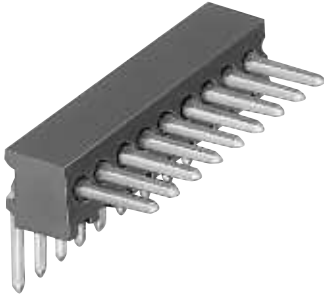

Material and Finish

Housing — Glass-filled thermoplastic, black, 94V-0 rated

Contacts — Copper alloy; duplex plated .000030 [0.00076] gold in mating area, .000150 [0.00381] tin on solder posts, with entire contact underplated .000050 [0.00127] nickel

Related Product Data

Performance Characteristics — page 63

Mateable Connectors — pages 37, 38, 49, & 50

PC Board Hole Layout — page 41

Technical Documents — page 64

Product Specification 108-1093

Application Specification 114-25031

| No. of Pos. | Dimension A | Part Numbers |
|-------------|---------------|--------------|
| 4 | .215 [5.46] | 5-104186-1 |
| 8 | .415 [10.54] | 5-104186-5 |
| 12 | .615 [15.62] | 5-104186-7 |
| 15 | .765 [19.43] | 5-104186-9 |
| 17 | .865 [21.97] | 6-104186-0 |
| 20 | 1.015 [25.78] | 6-104186-1 |
| 25 | 1.265 [32.13] | 6-104186-3 |
| 30 | 1.515 [38.48] | 6-104186-5 |
| 31 | 1.565 [39.75] | 7-104186-0 |
| 40 | 2.015 [51.18] | 6-104186-7 |

Note: All part numbers are RoHS compliant.

Thru-Hole Headers—Unshrouded, .050 x .100 [1.27 x 2.54] Centerline, Board-to-Board (Continued)

Single Row, Vertical

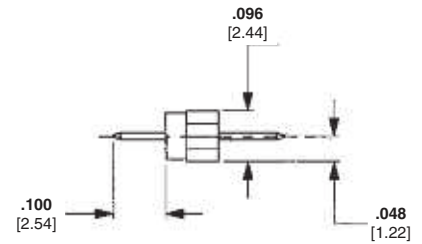
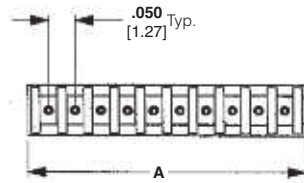
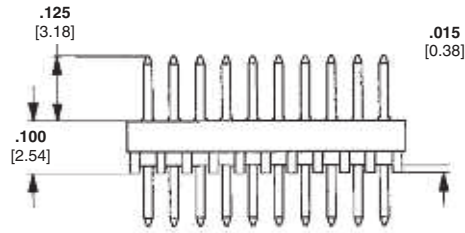
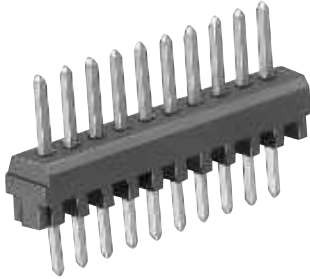

Material and Finish

Housing — Glass-filled thermoplastic, black, 94V-0 rated

Contacts — Copper alloy; duplex plated .000030 [0.00076] gold in mating area, .000150 [0.00381] tin on solder posts, with entire contact underplated .000050 [0.00127] nickel

Related Product Data

Performance Specifications — page 63

Mateable Connectors — pages 37, 38, 49, & 50

Board-to-Board Spacing — page 63

PC Board Hole Layout — page 41

Technical Documents — page 64

Product Specification 108-1093

Application Specification 114-25031

| No. of Pos. | Dimension A | Part Numbers |
|-------------|---------------|--------------|
| 4 | .215 [5.46] | 5-104178-1 |
| 6 | .315 [8.00] | 5-104178-3 |
| 8 | .415 [10.54] | 5-104178-5 |
| 10 | .515 [13.08] | 5-104178-6 |
| 20 | 1.015 [25.78] | 6-104178-1 |
| 25 | 1.265 [32.13] | 6-104178-3 |

Note: All part numbers are RoHS compliant.

Thru-Hole Headers—Unshrouded, .050 x .100 [1.27 x 2.54] Centerline, Board-to-Board (Continued)

Double Row, Right-Angle

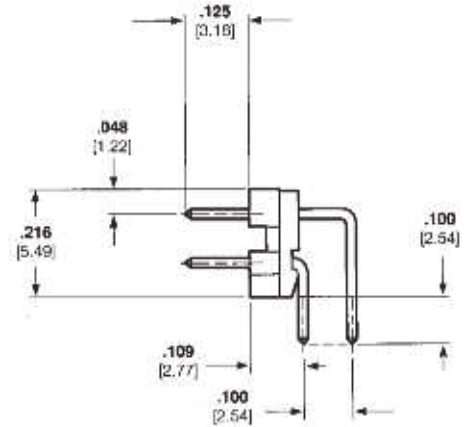
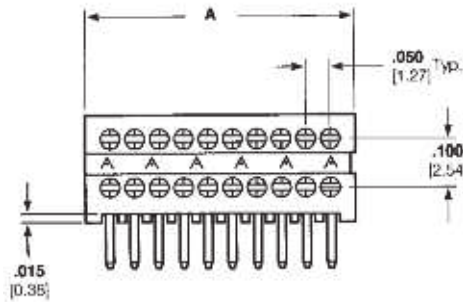
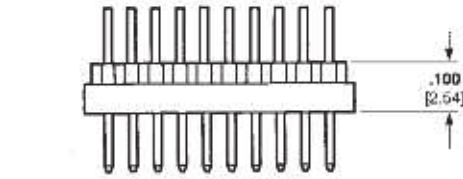
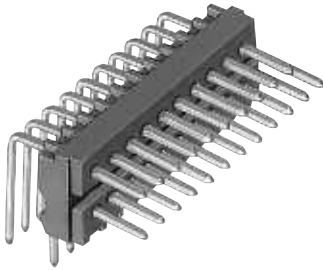

Material and Finish

Housing — Glass-filled thermoplastic, black, 94V-0 rated

Contacts — Copper alloy; duplex plated .000030 [0.00076] gold in mating area, .000150 [0.00381] tin on solder posts, with entire contact underplated .000050 [0.00127] nickel

Related Product Data

Performance Specifications — page 63

Mateable Connectors — pages 39, 40, 45, 51 & 52

PC Board Hole Layout — page 41

Technical Documents — page 64

Product Specification 108-1093

Application Specification 114-25031

| No. of Pos. | Dimension A | Part Numbers |
|-------------|---------------|--------------|
| 10 | .265 [6.73] | 5-104118-3 |
| 20 | .515 [13.08] | 5-104118-7 |
| 30 | .765 [19.43] | 6-104118-0 |
| 40 | 1.015 [25.78] | 6-104118-2 |
| 50 | 1.265 [32.13] | 5-104118-1 |
| 60 | 1.515 [38.48] | 6-104118-4 |
| 80 | 2.015 [51.18] | 6-104118-6 |
| 100 | 2.515 [63.88] | 6-104118-7 |

Note: All part numbers are RoHS compliant.

Headers, Shrouded and Unshrouded

3

Thru-Hole Headers—Unshrouded, .050 x .100 [1.27 x 2.54] Centerline, Board-to-Board (Continued)

Double Row, Vertical

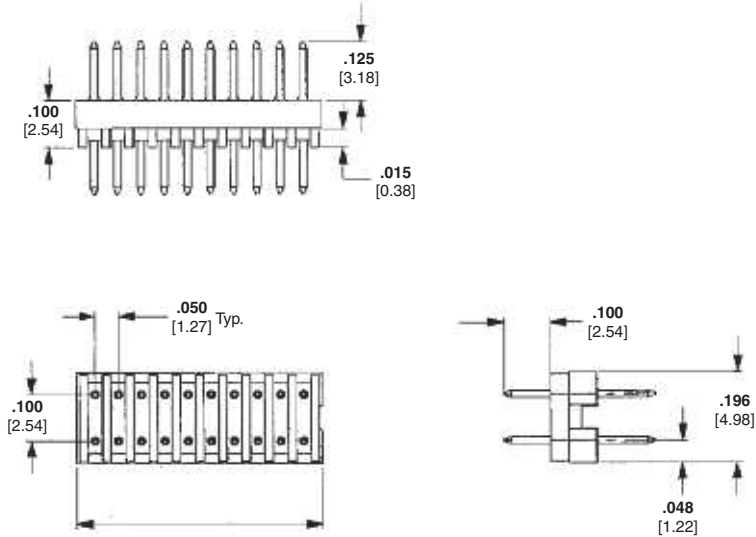
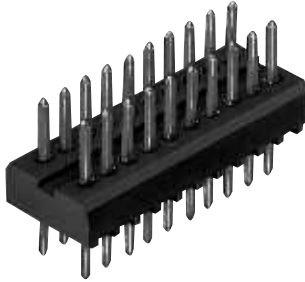

Material and Finish

Housing — Glass-filled thermoplastic, black, 94V-0 rated

Contacts — Copper alloy; duplex plated .000030 [0.00076] gold in mating area, .000150 [0.00381] tin on solder posts, with entire contact underplated .000050 [0.00127] nickel

Related Product Data

Performance Characteristics — page 63

Mateable Connectors — pages 39, 40, 45, 51, & 52

Board-to-Board Spacing — page 63

PC Board Hole Layout — page 42

Technical Documents — page 64

Product Specification 108-1093

Application Specification 114-25031

| No. of Pos. | Dimension A | Part Numbers |
|-------------|---------------|--------------|
| 8 | .215 [5.46] | 5-103916-3 |
| 20 | .515 [13.08] | 5-103916-2 |
| 30 | .765 [19.43] | 5-103916-9 |
| 36 | .915 [23.24] | 6-103916-8 |
| 40 | 1.015 [25.78] | 6-103916-1 |
| 50 | 1.265 [32.13] | 6-103916-3 |
| 60 | 1.515 [38.48] | 6-103916-4 |
| 80 | 2.015 [51.18] | 6-103916-6 |
| 100 | 2.515 [63.88] | 6-103916-7 |

Note: All part numbers are RoHS compliant.

Thru-Hole Receptacles, .050 x .100 [1.27 x 2.54] Centerline, Board-to-Board

Product Facts

- High density; contacts spaced on .050 x .100 [1.27 x 2.54] centers
- Right-angle and vertical styles
- Single row; select sizes 5 thru 50 positions
- Double row; select sizes 10 thru 100 positions
- Contacts are selectively plated with gold
- Stand-offs for removal of solder flux

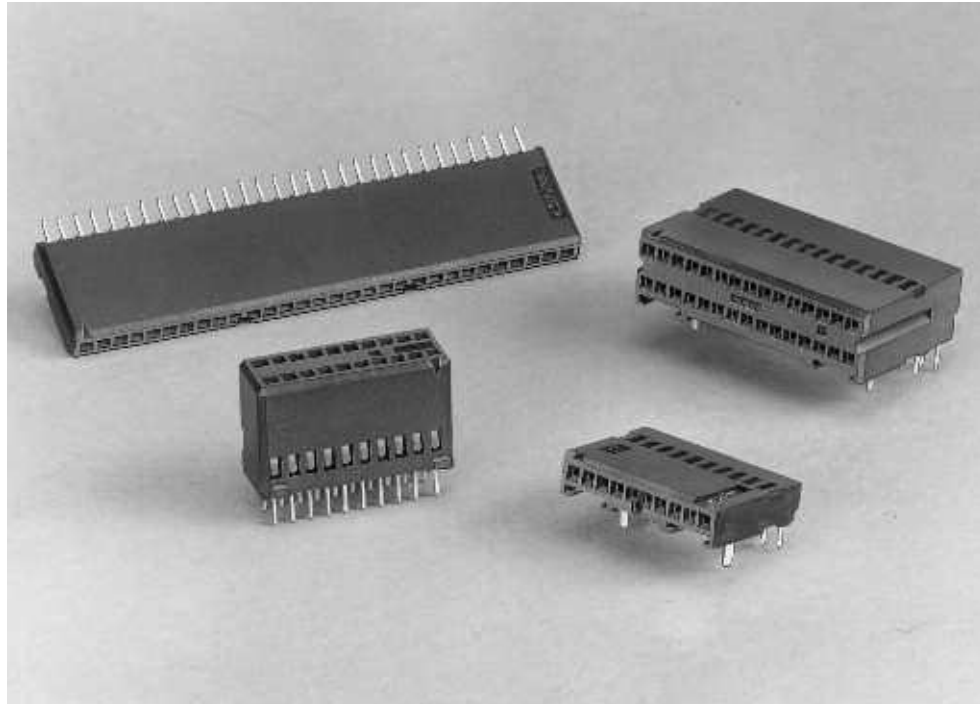

The AMPMODU System 50 thru-hole receptacles offer a wide variety of high density board-to-board connectors. The .050 [1.27] spacing between each contact provides an extremely dense interconnect package and results in a more efficient use of the printed circuit board space.

AMPMODU System 50 thru-hole receptacles are available in right-angle and vertical configurations and are composed of single and double row versions. The single row versions are available in select sizes of 5 thru 50 positions and double row in positions from 10 thru 100.

Receptacle contacts and mating .015 [0.38] square posts are formed from high conductivity copper alloy and are selectively plated with gold for higher performance and reliability. The receptacle housings are made of black thermoplastic, with a 94V-0 rating to withstand high temperatures of reflow soldering and incorporate stand-offs for free drainage of flux cleaning solutions.

Thru-Hole Receptacles, .050 x .100 [1.27 x 2.54] Centerline, Board-to-Board (Continued)

Single Row, Right-Angle With Solder Clips

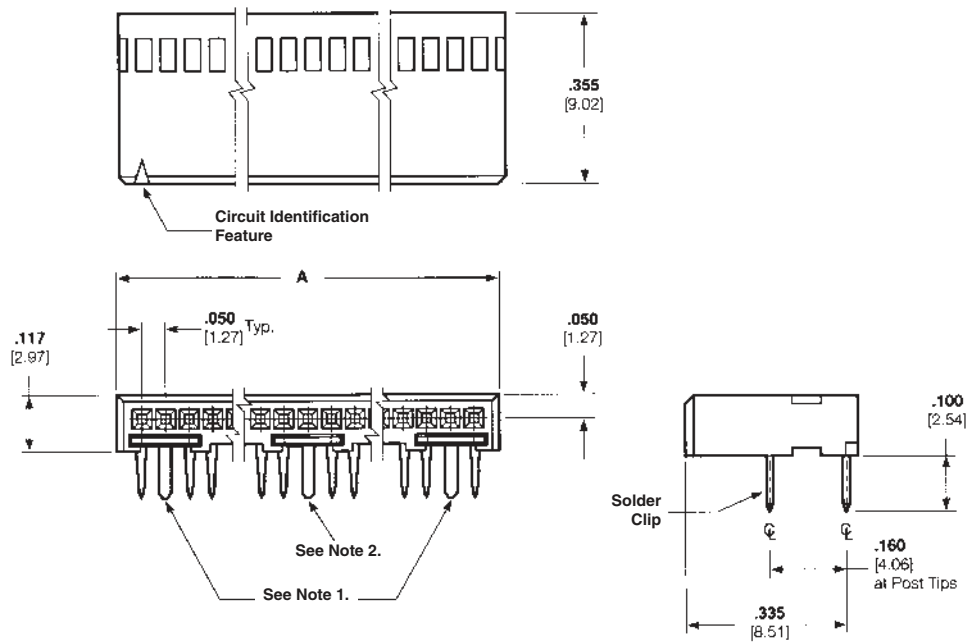

Material and Finish

Housing — Glass-filled thermoplastic, black, 94V-0 rated

Contacts — Copper alloy; duplex plated .000030 [0.00076] gold in mating area, .000150 [0.00381] tin on solder posts, with entire contact underplated .000050 [0.00127] nickel

Related Product Data

Performance Specifications — page 63

Mateable Connectors — pages 32 & 33

PC Board Hole Layout — page 41

Technical Documents — page 64

Product Specification 108-1093

Application Specification 114-25031

| No. of Pos. | Dimension A | Part Numbers |
|-------------|---------------|--------------|
| 10 | .544 [13.82] | 5-104196-2 |
| 15 | .794 [20.17] | 5-104196-4 |
| 20 | 1.044 [26.52] | 5-104196-5 |

Notes:

- Solder Clips located as shown for 10 through 25 position receptacles.
- Solder Clips located as shown for 5 and 25 position receptacles.

Note: All part numbers are RoHS compliant.

Thru-Hole Receptacles, .050 x .100 [1.27 x 2.54] Centerline, Board-to-Board (Continued)

Single Row, Vertical

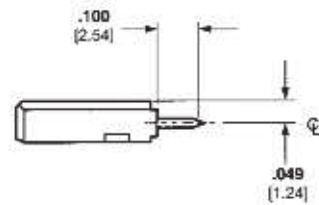
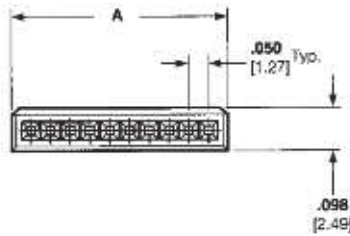
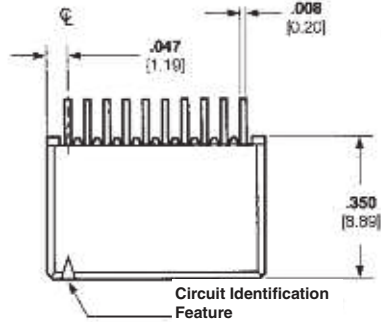
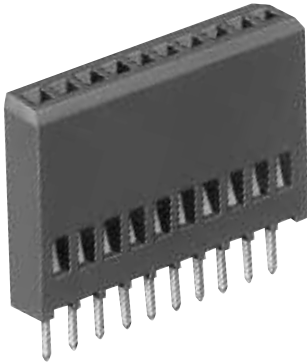

Material and Finish

Housing — Glass-filled thermoplastic, black, 94V-0 rated

Contacts — Copper alloy; duplex plated .000030 [0.00076] gold in mating area, .000150 [0.00381] tin on solder posts, with entire contact underplated .000050 [0.00127] nickel

Related Product Data

Performance Specifications — page 63

Mateable Connectors — pages 27, 28, 32, & 33

Board-to-Board Spacing — page 63

PC Board Hole Layout — page 41

Technical Documents — page 64

Product Specification 108-1093

Application Specification 114-25031

| No. of Pos. | Dimension A | Part Numbers |
|-------------|---------------|--------------|
| 10 | .544 [13.82] | 5-104192-2 |
| 12 | .644 [16.35] | 5-104192-3 |
| 15 | .794 [20.17] | 5-104192-4 |
| 20 | 1.044 [26.52] | 5-104192-5 |
| 30 | 1.544 [39.22] | 5-104192-7 |

Note: All part numbers are RoHS compliant.

Thru-Hole Receptacles, .050 x .100 [1.27 x 2.54] Centerline, Board-to-Board (Continued)

Double Row, Right-Angle

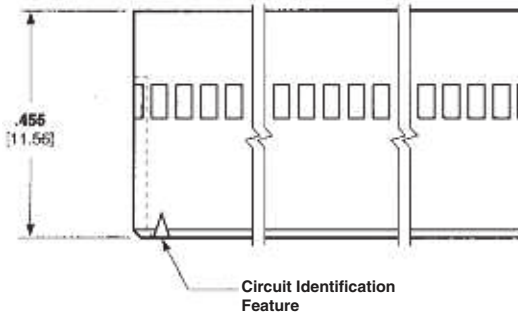
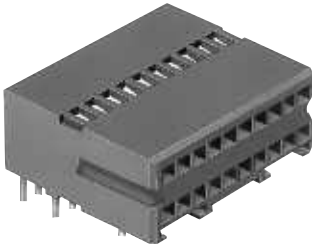

Material and Finish

Housing — Glass-filled thermoplastic, black, 94V-0 rated

Contacts — Copper alloy; duplex plated .000030 [0.00076] gold in mating area, .000150 [0.00381] tin on solder posts, with entire contact underplated .000050 [0.00127] nickel

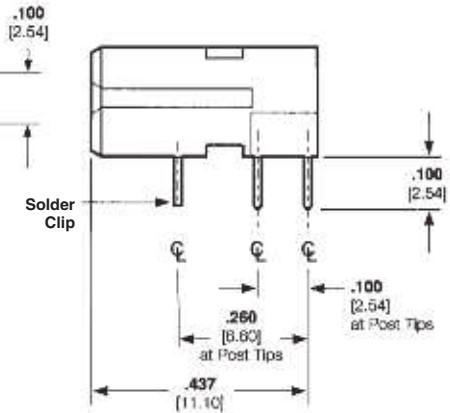
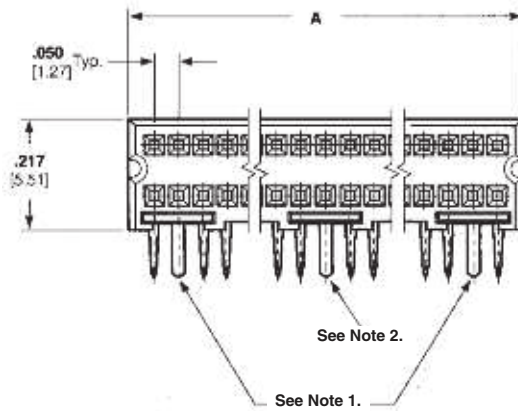

Related Product Data

Performance Characteristics — page 63

Mateable Connectors — pages 31, 34 & 35

PC Board Hole Layout — page 41

Technical Documents — page 64

Product Specification 108-1093

Application Specification 114-25031

| No. of Pos. | Dimension A | Part Numbers |
|-------------|---------------|--------------|
| 10 | .294 [7.47] | 5-103911-1 |
| 20 | .544 [13.82] | 5-103911-2 |
| 30 | .794 [20.17] | 5-103911-7 |
| 40 | 1.044 [26.52] | 5-103911-5 |
| 50 | 1.294 [32.87] | 5-103911-4 |
| 60 | 1.544 [39.22] | 5-103911-3 |
| 80 | 2.044 [51.92] | 5-103911-6 |
| 100 | 2.544 [64.62] | 5-103911-8 |

Notes:

1. Solder Clips located as shown for 20 through 100 position receptacles.
2. Solder Clips located as shown for 10, 60, 80 and 100 position receptacles.

Note: All part numbers are RoHS compliant.

Thru-Hole Receptacles, .050 x .100 [1.27 x 2.54] Centerline, Board-to-Board (Continued)

Double Row, Vertical

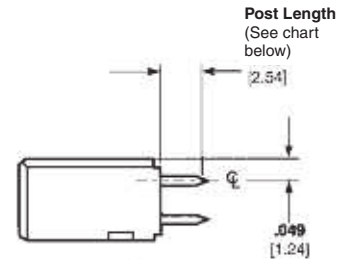
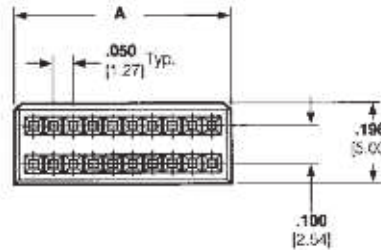
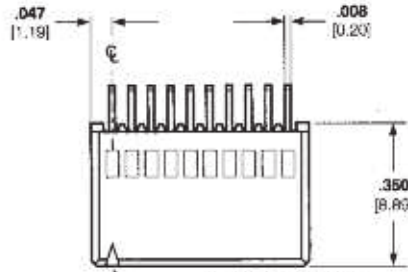
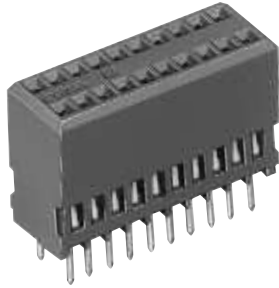

Material and Finish

Housing — Glass-filled thermoplastic, black, 94V-0 rated

Contacts — Copper alloy; duplex plated .000030 [0.00076] gold in mating area, .000150 [0.00381] tin on solder posts, with entire contact underplated .000050 [0.00127] nickel

Related Product Data

Performance Specifications — page 63

Mateable Connectors — pages 29, 30, 34, 35 & 44

Board-to-Board Spacing — page 63

PC Board Hole Layout — page 41

Technical Documents — page 64

Product Specification 108-1093

Application Specification

114-25031

| No. of Pos. | Dimension A | Part Numbers Post Length | |
|-------------|---------------|--------------------------|-------------|
| | | .100 [2.54] | .145 [3.68] |
| 10 | .294 [7.47] | 5-104078-3 | — |
| 20 | .544 [13.82] | 5-104078-1 | — |
| 24 | .644 [16.36] | 5-104078-9 | — |
| 30 | .794 [20.17] | 5-104078-4 | — |
| 34 | .894 [22.71] | 6-104078-0 | — |
| 40 | 1.044 [26.52] | 5-104078-2 | — |
| 50 | 1.294 [32.87] | 5-104078-5 | 5-104744-7 |
| 60 | 1.544 [39.22] | 5-104078-6 | — |
| 68 | 1.744 [44.30] | 6-104078-3 | — |
| 80 | 2.044 [51.92] | 5-104078-7 | 5-104744-4 |
| 100 | 2.544 [64.62] | 5-104078-8 | 5-104744-5 |

Note: All part numbers are RoHS compliant.

Recommended PC Board Hole Layouts, Thru-Hole Board-to-Board Connectors

Single Row, Right-Angle with Solder Clips

Note: Consult TE for customer drawings detailing tolerances.

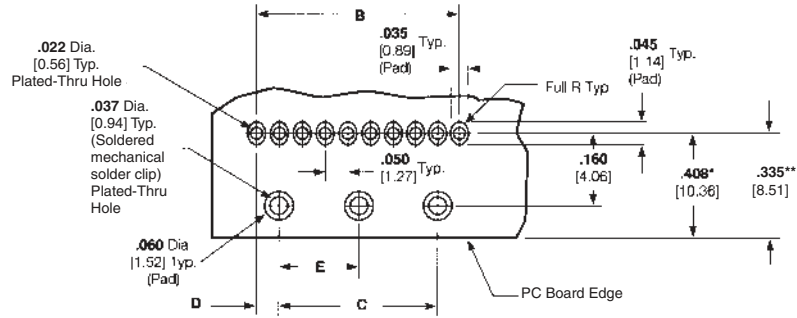

* This dimension is for Shrouded, Single Row Right-Angle Headers only.

** This dimension is for Single Row Right-Angle Receptacles only.

| No. of Pos. | Dimensions | | | |
|-------------|---------------|---------------|-------------|---------------|
| | B | C | D | E |
| 4 | .150 [3.81] | — | .075 [1.91] | — |
| 5 | .200 [5.08] | — | .100 [2.54] | — |
| 6 | .250 [6.35] | — | .125 [3.18] | — |
| 8 | .350 [8.89] | — | .175 [4.45] | — |
| 10 | .450 [11.43] | .350 [8.89] | .050 [1.27] | — |
| 12 | .550 [13.97] | .450 [11.43] | .050 [1.27] | — |
| 15 | .700 [17.78] | .600 [15.24] | .050 [1.27] | — |
| 20 | .950 [24.13] | .850 [21.59] | .050 [1.27] | — |
| 22 | 1.050 [26.67] | .950 [24.13] | .050 [1.27] | — |
| 25 | 1.200 [30.48] | 1.100 [27.94] | .050 [1.27] | — |
| 28 | 1.350 [34.29] | 1.250 [31.75] | .050 [1.27] | .625 [15.88] |
| 30 | 1.450 [36.83] | 1.350 [34.29] | .050 [1.27] | .675 [17.15] |
| 36 | 1.750 [44.45] | 1.650 [41.91] | .050 [1.27] | .825 [20.96] |
| 40 | 1.950 [49.53] | 1.850 [46.99] | .050 [1.27] | .925 [23.50] |
| 45 | 2.200 [55.88] | 2.100 [53.34] | .050 [1.27] | 1.050 [26.67] |
| 50 | 2.450 [62.23] | 2.350 [59.69] | .050 [1.27] | 1.175 [29.85] |

Double Row, Right-Angle with Solder Clips

Note: Consult TE for customer drawings detailing tolerances.

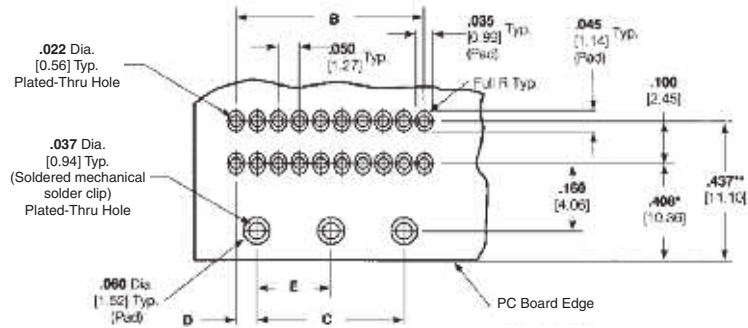

* This dimension is for Shrouded, Double Row Right-Angle Headers only.

** This dimension is for Double Row Right-Angle Receptacles only.

| No. of Pos. | Dimensions | | | |
|-------------|---------------|---------------|-------------|---------------|
| | B | C | D | E |
| 10 | .200 [5.08] | — | .100 [2.54] | — |
| 20 | .450 [11.43] | .350 [8.89] | .050 [1.27] | — |
| 24 | .550 [13.97] | .450 [11.43] | .050 [1.27] | — |
| 26 | .600 [15.24] | .500 [12.70] | .050 [1.27] | — |
| 30 | .700 [17.78] | .600 [15.24] | .050 [1.27] | — |
| 34 | .800 [20.32] | .700 [17.78] | .050 [1.27] | — |
| 40 | .950 [24.13] | .850 [21.59] | .050 [1.27] | — |
| 50 | 1.200 [30.48] | 1.100 [27.94] | .050 [1.27] | — |
| 60 | 1.450 [36.83] | 1.350 [34.29] | .050 [1.27] | .675 [17.15] |
| 68 | 1.650 [41.91] | 1.550 [39.37] | .050 [1.27] | .775 [19.69] |
| 72 | 1.750 [44.45] | 1.650 [41.91] | .050 [1.27] | .825 [20.96] |
| 80 | 1.950 [49.53] | 1.850 [46.99] | .050 [1.27] | .925 [23.50] |
| 100 | 2.450 [62.23] | 2.350 [59.69] | .050 [1.27] | 1.175 [29.85] |

Recommended PC Board Hole Layouts, Thru-Hole Board-to-Board Connectors (Continued)

Single Row Without Solder Clips

Note: Consult TE for customer drawings detailing tolerances.

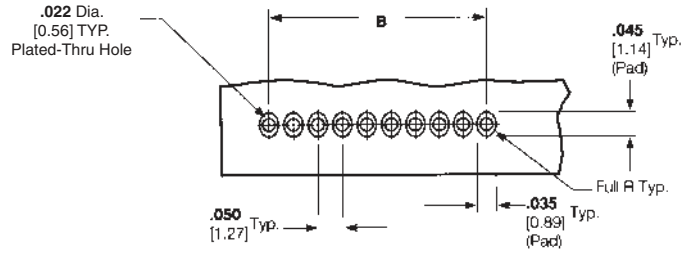

| No. of Pos. | Dimension B |
|-------------|--------------|
| 4 | .150 [3.81] |
| 5 | .200 [5.08] |
| 6 | .250 [6.35] |
| 8 | .350 [8.89] |
| 10 | .450 [11.43] |
| 12 | .550 [13.97] |
| 13 | .600 [15.24] |
| 15 | .700 [17.78] |

| No. of Pos. | Dimension B |
|-------------|---------------|
| 17 | .800 [20.32] |
| 20 | .950 [24.13] |
| 22 | 1.050 [26.67] |
| 25 | 1.200 [30.48] |
| 30 | 1.450 [36.83] |
| 31 | 1.500 [38.10] |
| 36 | 1.750 [44.45] |
| 40 | 1.950 [49.53] |
| 50 | 2.450 [62.23] |

Double Row Without Solder Clips

Note: Consult TE for customer drawings detailing tolerances.

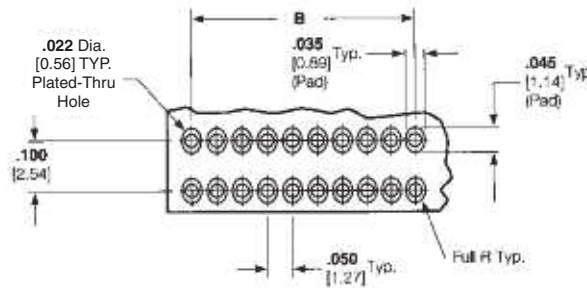

| No. of Pos. | Dimension B |
|-------------|--------------|
| 8 | .150 [3.81] |
| 10 | .200 [5.08] |
| 12 | .250 [6.35] |
| 14 | .300 [7.62] |
| 16 | .350 [8.89] |
| 20 | .450 [11.43] |
| 24 | .550 [13.97] |
| 26 | .600 [15.24] |
| 30 | .700 [17.78] |
| 34 | .800 [20.32] |

| No. of Pos. | Dimension B |
|-------------|---------------|
| 36 | .850 [21.59] |
| 40 | .950 [24.13] |
| 44 | 1.050 [26.67] |
| 50 | 1.200 [30.48] |
| 60 | 1.450 [36.83] |
| 68 | 1.650 [41.91] |
| 72 | 1.750 [44.45] |
| 80 | 1.950 [49.53] |
| 100 | 2.450 [62.23] |

PC Board Hole Layouts

3

Surface-Mount Connectors, .050 x .100 [1.27 x 2.54] Centerline, Board-to-Board

Product Facts

- Surface-mount option for parallel board-to-board applications; completely intermateable with AMPMODU System 50 thru-hole board-to-board and cable-to-board systems
- Double row, vertical, shrouded header and receptacle assemblies
- Available in select sizes from 10 through 100 positions
- High Density; contacts spaced on .050 x .100 [1.27 x 2.54] centers; compact footprint
- Compatible with standard surface-mount processes
- Stand-offs for free drainage of flux cleaning solutions; visible solder joints for easy inspection
- Simple, low insertion-force hold-down for process retention and long-term strain relief for solder joints
- Available in tape and reel packaging (with vacuum covers) for automatic placement.

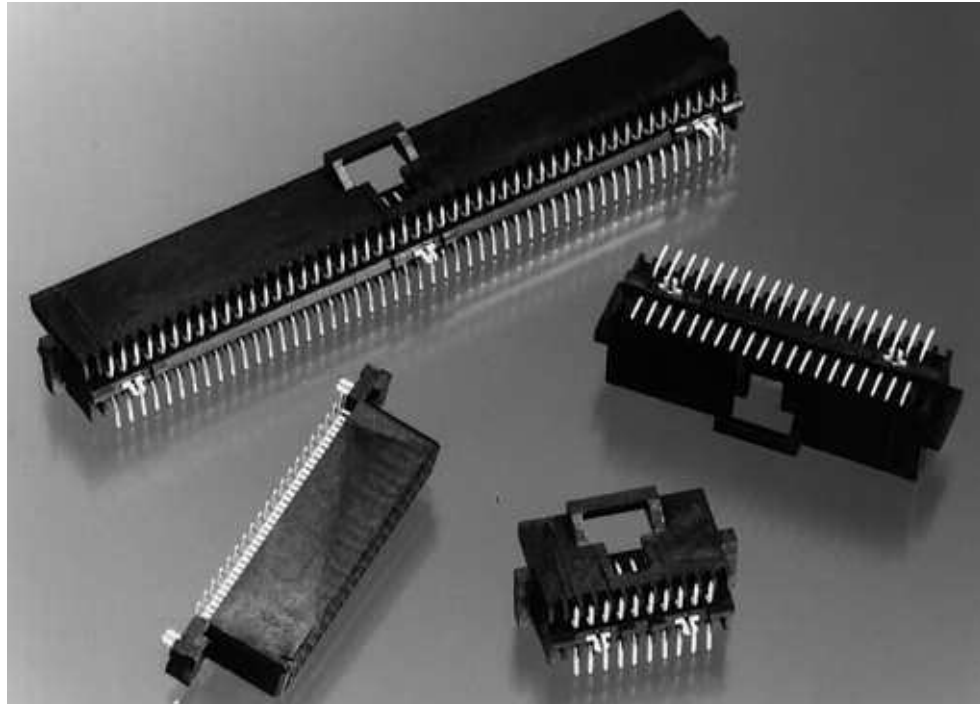

The high-density surface-mount connector is another mounting option in the AMPMODU System 50 connector family.

This surface-mount system is fully intermateable with the AMPMODU System 50 thru-hole and cable-to-board connectors.

Additionally, the design of the mating interface has not been changed, maintaining the same high reliability as the thru-hole product.

The surface-mount system includes double row, vertical, shrouded header and receptacle assemblies in select sizes from 10 through 100 positions. It meets the tight dimensional requirements of surface-mount technology. The simple, low insertion-force hold-down provides both processing retention and long-term strain relief for the solder joints in the headers and receptacles.

Surface-Mount Headers, .050 x .100 [1.27 x 2.54] Centerline, Board-to-Board

Double Row, Vertical

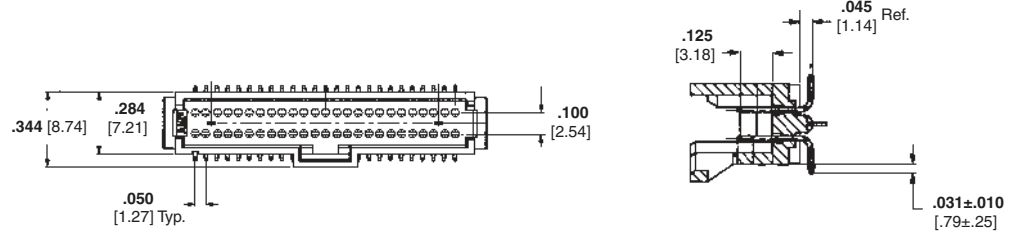
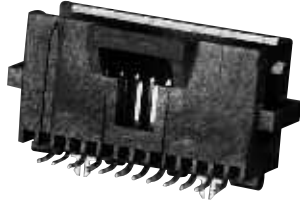

Material and Finish

Housing — Glass-filled thermoplastic, black, 94V-0 rated

Contacts — Copper alloy; duplex plated .000030 [0.00076] gold in mating area, .000150 [0.00381] tin on solder tail, with entire contact under-plated .000050 [0.00127] nickel

Holddown — Copper alloy, plated .000150 [0.00381] tin over .000050 [0.00127] nickel

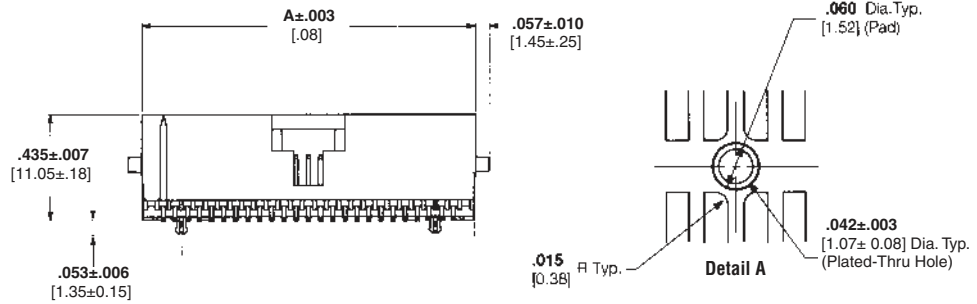

Related Product Data

Performance Characteristics — page 63

Mateable Connectors — pages 40, 45, 51, 52, & 56

Board-to-Board Spacing — page 63

Technical Documents — page 64

Product Specification 108-1093

Application Specification 114-25035

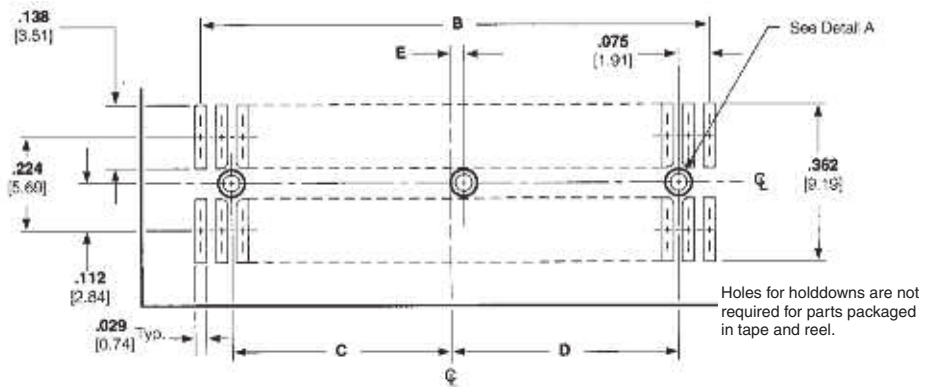

Recommended PC Board Layout

| No. of Pos. | Dimensions | | | | | Part Numbers | |
|-------------|---------------|---------------|---------------|---------------|-------------|--------------|---------------------|
| | A | B | C | D | E | Pkg in Tube | Pkg in Tape & Reel* |
| 10 | .380 [9.65] | .200 [5.08] | — | .025 [0.64] | — | 5-104549-1 | 5-147377-1 |
| 12 | .430 [10.92] | .250 [6.35] | — | — | — | 6-104549-1 | — |
| 20 | .630 [16.00] | .450 [11.43] | .150 [3.81] | .150 [3.81] | — | 5-104549-2 | 5-147377-2 |
| 24 | .730 [18.54] | .550 [13.97] | .200 [5.08] | .200 [5.08] | — | 5-104549-3 | 5-147377-9 |
| 30 | .880 [22.35] | .700 [17.78] | .275 [6.99] | .275 [6.99] | — | 5-104549-5 | 5-147377-3 |
| 40 | 1.130 [28.70] | .950 [24.13] | .400 [10.16] | .400 [10.16] | — | 5-104549-6 | 5-147377-4 |
| 50 | 1.380 [35.05] | 1.200 [30.48] | .525 [13.34] | .525 [13.34] | .025 [0.64] | 5-104549-7 | 5-147377-5 |
| 60 | 1.630 [41.40] | 1.450 [36.83] | .650 [16.51] | .650 [16.51] | .000 | 5-104549-8 | 5-147377-6 |
| 80 | 2.130 [54.10] | 1.950 [49.53] | .900 [22.86] | .900 [22.86] | .000 | 5-104549-9 | 5-147377-7 |
| 100 | 2.630 [66.80] | 2.450 [62.23] | 1.150 [29.21] | 1.150 [29.21] | .000 | 6-104549-0 | 5-147377-8 |

*Parts packaged in tape and reel are without hold downs and include a vacuum pick and place cover

Note: All part numbers are RoHS compliant.

Surface-Mount Receptacles, .050 x .100 [1.27 x 2.54] Centerline, Board-to-Board

Double Row, Vertical

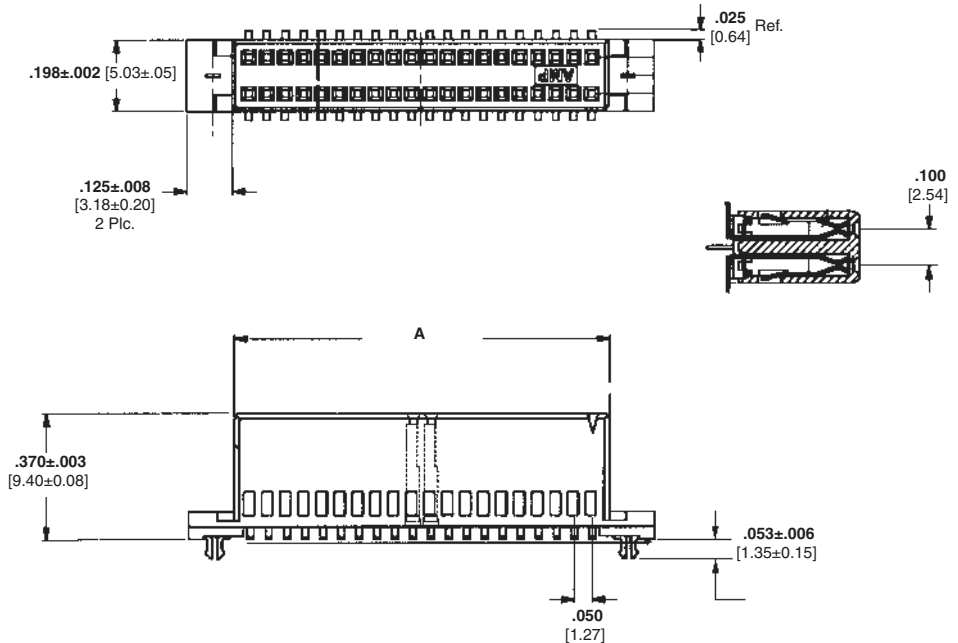

Material and Finish

Housing — Glass-filled thermoplastic, black, 94V-0 rated

Contacts — Phosphor bronze; duplex plated .000030 [0.00076] gold in mating area, .000150 [0.00381] tin on solder tail, with entire contact underplated .000050 [0.00127] nickel

Holddown — Copper alloy; duplex plated .000150 [0.00381] tin over .000050 [0.00127] nickel

Related Product Data

Performance Characteristics — page 63

Mateable Connectors — pages 29, 30, 34, 35 & 44

Board-to-Board Spacing — page 63

Technical Documents — page 64

Product Specification 108-1093

Application Specification
114-25035

Recommended PC Board Layout

| No. of Pos. | Dimensions | | | Part Numbers | |
|-------------|---------------|---------------|---------------|--------------|---------------------|
| | A | B | C | Pkg in Tube | Pkg in Tape & Reel* |
| 10 | .294 [7.47] | .200 [5.08] | .400 [10.16] | 5-104550-1 | 5-147378-1 |
| 20 | .544 [13.82] | .450 [11.43] | .650 [16.51] | 5-104550-2 | 5-147378-2 |
| 24 | .644 [16.36] | .550 [13.97] | .750 [19.05] | 5-104550-3 | 5-147378-9 |
| 30 | .794 [20.17] | .700 [17.78] | .900 [22.86] | 5-104550-4 | 5-147378-3 |
| 40 | 1.044 [26.52] | .950 [24.13] | 1.150 [29.21] | 5-104550-5 | 5-147378-4 |
| 50 | 1.294 [32.87] | 1.200 [30.48] | 1.400 [35.56] | 5-104550-6 | 5-147378-5 |
| 60 | 1.544 [39.22] | 1.450 [36.83] | 1.650 [41.91] | 5-104550-7 | 5-147378-6 |
| 80 | 2.044 [51.92] | 1.950 [49.53] | 2.150 [54.61] | 5-104550-8 | 5-147378-7 |
| 100 | 2.544 [64.62] | 2.450 [62.23] | 2.650 [67.31] | 5-104550-9 | 5-147378-8 |

*Parts packaged in tape and reel are without hold downs and include a vacuum pick and place cover

Note: All part numbers are RoHS compliant.

Cable-to-Board Connectors, .050 x .100 [1.27 x 2.54] Centerline FFC Cable

Product Facts

- Signal application only, 1.5 amperes maximum single circuit
- Single or double row connectors
- Terminates flexible flat conductor cable and flexible etched circuitry
- Shielded cable provides for customizing
- Center latch housing providing positive latching

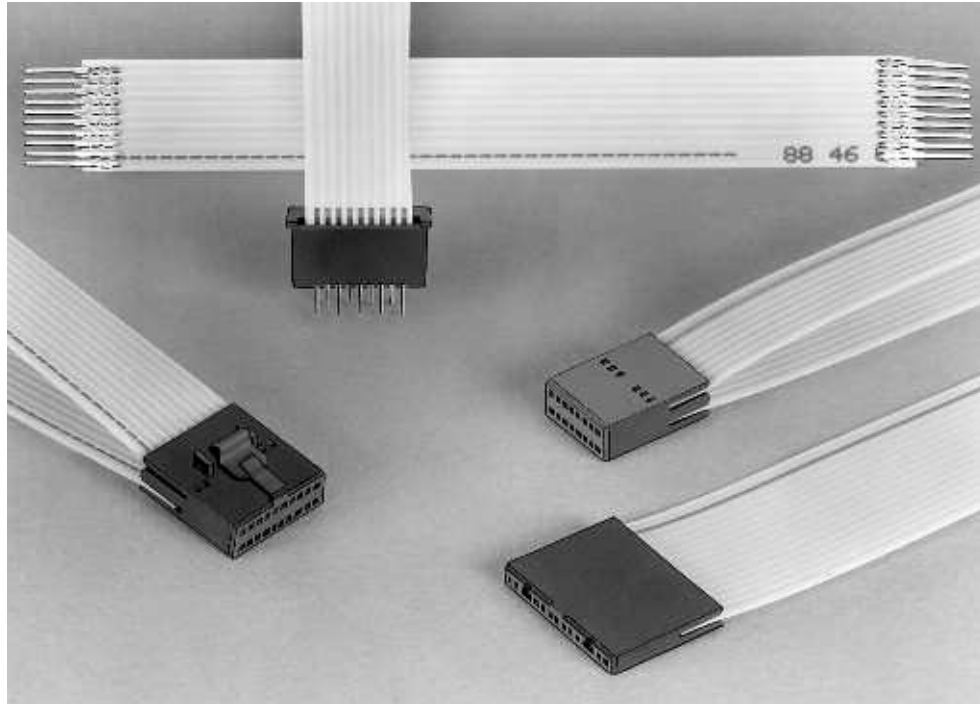

The cable-to-board .050 [1.27] center FFC receptacle connectors are part of the AMPMODU System 50 family for terminating flexible flat conductor cable and flexible etched circuitry.

The FFC receptacle uses a dual beam contact with 30 microinches of gold plating. The FFC receptacle connectors have an integral latch for positive locking to shrouded mating headers.

Flexible flat conductor cable is a planar parallel conductor cable. It can be used as a one-to-one connector or as a complex harness, allowing split-outs and special routing. The cable is comprised of .026 [0.66] wide x .003 [0.08] thick conductors made of copper per QQ-C-502 and insulated with a flame retardant polyester film.

The FFC contacts are available in receptacle and

solder tab. Receptacle contacts are made of phosphor bronze with a finish of plated gold duplex, while the solder tab contacts are finished in a bright tin-lead overall.

The complete product line provides solder tabs for board mounting at low cost and custom shielding of the cable.

Cable-to-Board Connectors, .050 x .100 [1.27 x 2.54] Centerline FFC Cable] (Continued)

Custom Designed Cable Assemblies

TE can supply customized flexible flat conductor cable assemblies using the components shown on pages 48 thru 54. Typical examples of these cable assemblies are shown to the right.

And, to meet the internal shielding requirements of today's complex electronic equipment, custom designed shielded FFC cable assemblies can be made to your specific specifications.

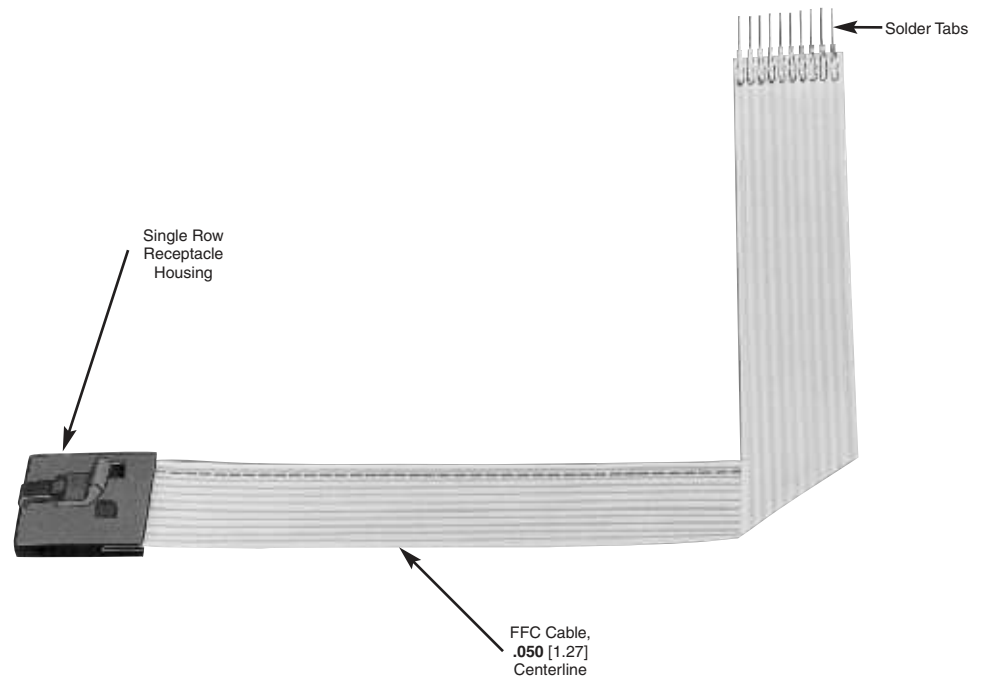
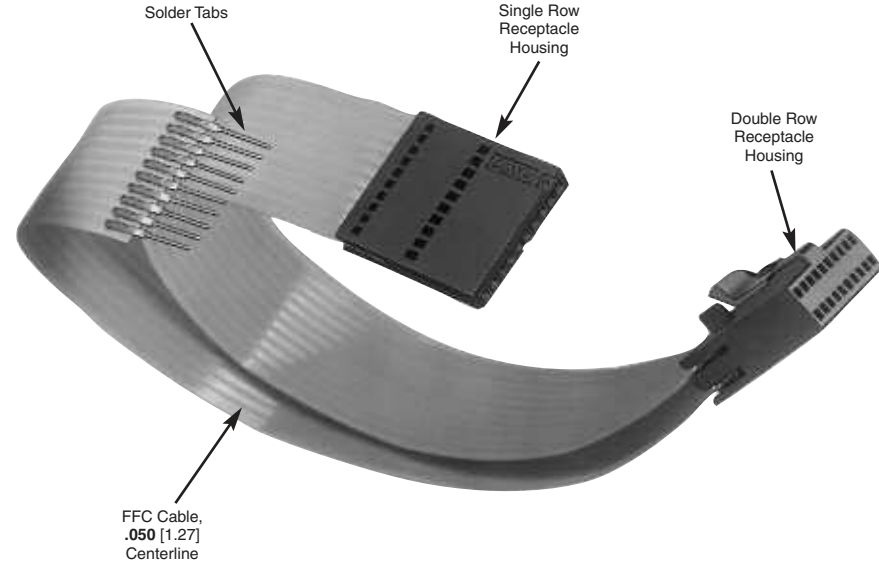

FFC Contacts, .050 x .100 [1.27 x 2.54] Centerline

Receptacle Strip

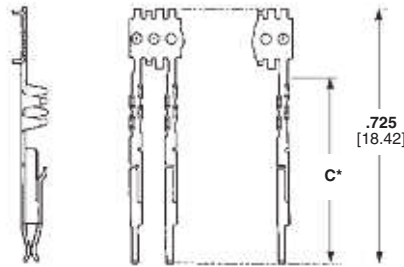

Solder Tab Strip

Receptacle

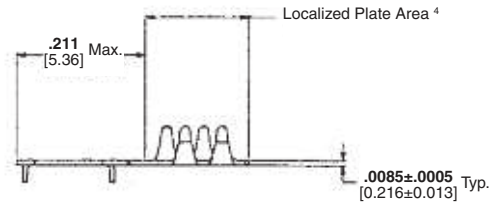
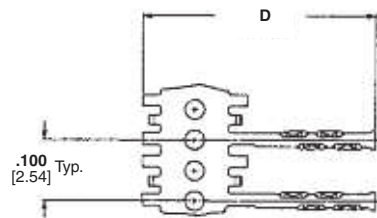
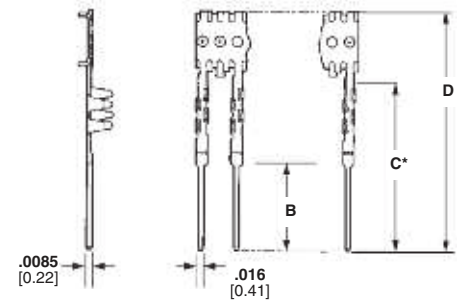
 Accepts .015 [0.38] Sq. Post
 .125-.350 [3.18-8.89] Long

Solder Tab

Material and Finish

Phosphor bronze; plated gold duplex or bright tin-lead overall (See chart.)

Related Product Data
Performance Characteristics — page 63

Housings — pages 49-52

Application Tooling — page 60-62

Technical Documents — page 64

Product Specification 108-16022

Application Specification
 114-16008

| Type | Config. | Contacts Part No./ Finish | Dimensions | | | Application Tooling Part Numbers | |
|----------------|---------|---------------------------------|----------------|-----------------|-----------------|-------------------------------------|----------------------------|
| | | | B | C* | D | Machine | Machine With Programmer |
| Receptacle | Strip | 1-487547-1 ¹ | — | .520 [13.21] | .725 [18.42] | | |
| | Strip | 487923-4 ² | .245 [6.22] | .480 [12.19] | .685 [17.40] | | |
| Solder Tab | Strip | 487923-5 ³ | .245 [6.22] | .480 [12.19] | .685 [17.40] | 224910-4 (120 V) | 318619-4 (120 V) |
| | Strip | 487940-4 ² | .110 [2.79] | .345 [8.76] | .550 [13.97] | 224910-6 (240 V) | 318619-6 (240 V) |
| Contact Splice | Strip | 487941-4 ⁴ | — | — | .385 [9.78] | | |
| Receptacle | Strip | 1-487547-2 ⁵ | — | .520 [13.21] | .725 [18.42] | | |

¹Duplex plated .000030 [0.00076] gold on mating area, .000100 [0.00254] min. bright tin in crimp area, with entire contact underplated .000050 [0.00127] min. nickel.

²Plated .000100 [0.00254] min. tin over .000050 [0.00127] min. nickel.

³Duplex plated .000015 [0.00038] gold on solder tab end, .000100 [0.00254] min. bright tin in crimp area, with entire contact underplated .000050 [0.00127] min. nickel.

⁴Plated .000150 [3.81µm] min. bright tin over .000050 [1.27µm] min. nickel.

⁵Duplex Plated .000150 [0.00038] gold on mating area, .000100 [0.00254] min bright tin in crimp area, with entire contact underplated .000050 [0.00127] min. nickel.

^{*}After cut-off from carrier strip.

Note: All part numbers are RoHS compliant.

Single Row Receptacle Housings, .050 x .100 [1.27 x 2.54] Centerline, Cable-to-Board



Plain Style Housings



Latch Style Housings

Material and Finish

Housing — Black thermoplastic, flame retardant, 94V-0 rated

Related Product Data

Performance Characteristics — page 63

Receptacle Contacts — page 48

Mateable Headers — pages 27, 28, 32 & 33

Technical Documents — page 64

Product Specification 108-16022

Application Specification 114-16008

Plain Style Housings

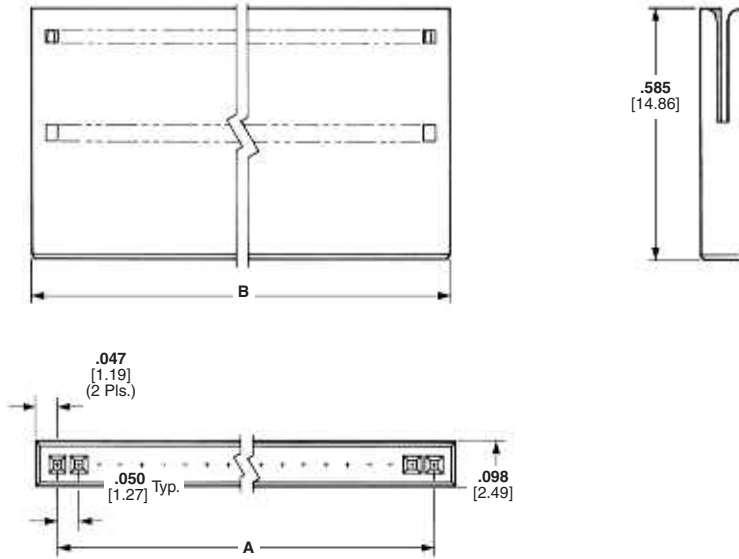

Latch Style Housings

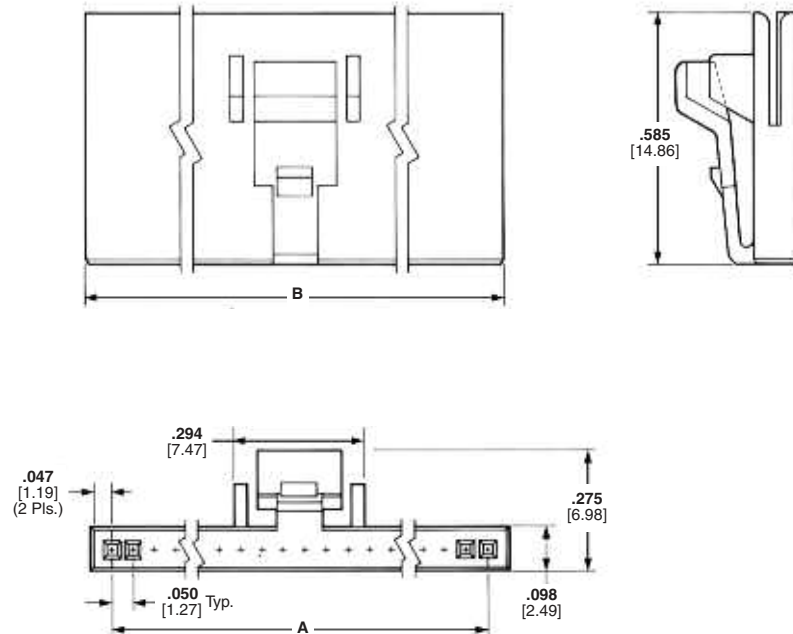

Single Row Receptacle Housings, .050 x .100 [1.27 x 2.54] Centerline, Cable-to-Board (Continued)

| No. of Pos. | Dimensions | | Part Numbers | |
|-------------|---------------|---------------|--------------------------|--------------------------------|
| | A | B | Plain Receptacle Housing | Latch Style Receptacle Housing |
| 4 | .150 [3.18] | .244 [6.20] | 487544-1 | 487545-1 |
| 5 | .200 [5.08] | .294 [7.47] | 487544-2 | 487545-2 |
| 6 | .250 [6.35] | .344 [8.74] | 487544-3 | 487545-3 |
| 7 | .300 [7.62] | .394 [10.01] | 487544-4 | 487545-4 |
| 8 | .350 [8.89] | .444 [11.28] | 487544-5 | 487545-5 |
| 10 | .450 [11.43] | .544 [13.82] | 487544-7 | 487545-7 |
| 12 | .550 [13.97] | .644 [16.36] | 487544-9 | 487545-9 |
| 13 | .600 [15.24] | .694 [17.63] | — | 1-487545-0 |
| 15 | .700 [17.78] | .794 [20.17] | 1-487544-2 | 1-487545-2 |
| 16 | .750 [19.05] | .844 [21.44] | 1-487544-3 | — |
| 17 | .800 [20.32] | .894 [22.71] | 1-487544-4 | 1-487545-4 |
| 20 | .950 [24.13] | 1.044 [26.52] | 1-487544-7 | 1-487545-7 |
| 22 | 1.050 [26.67] | 1.144 [29.06] | 1-487544-9 | 1-487545-9 |
| 25 | 1.200 [30.48] | 1.294 [32.87] | 2-487544-2 | 2-487545-2 |
| 26 | 1.250 [31.75] | 1.343 [34.11] | — | 2-487545-3 |
| 28 | 1.350 [34.29] | 1.443 [36.65] | — | 2-487545-5 |
| 30 | 1.450 [36.83] | 1.544 [39.22] | — | 2-487545-7 |
| 36 | 1.750 [44.45] | 1.844 [46.84] | 3-487544-3 | 3-487545-3 |
| 40 | 1.950 [49.53] | 2.044 [51.92] | — | 3-487545-7 |
| 45 | 2.200 [55.88] | 2.294 [58.27] | — | 4-487545-2 |
| 50 | 2.450 [62.23] | 2.544 [64.62] | 4-487544-7 | 4-487545-7 |

Note: Other sizes of receptacle housings (plain and latch style) can be made available, consult TE.

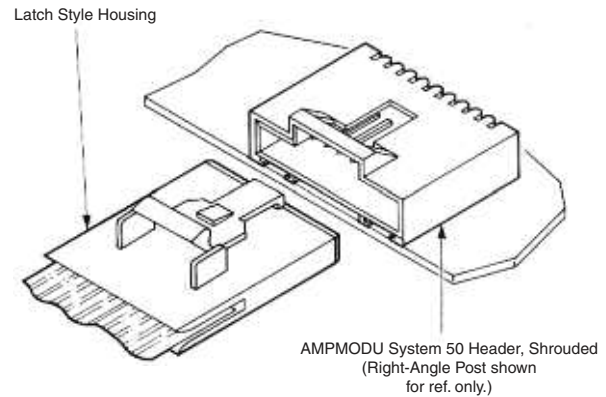
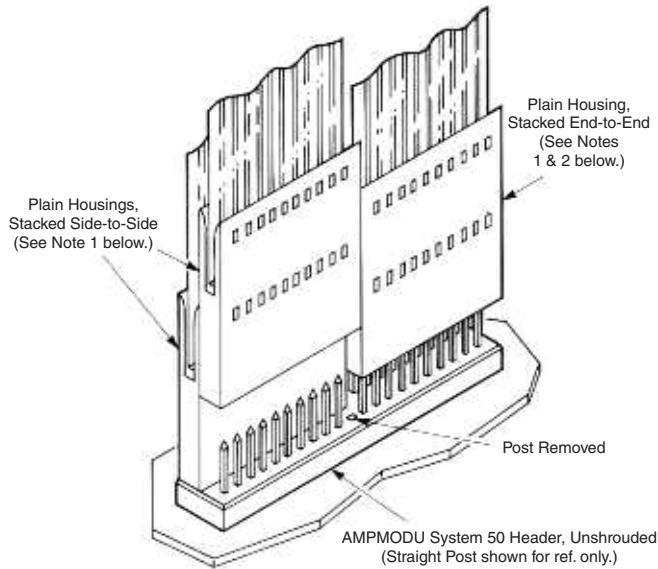

- Notes:**
1. Plain housings are side-to-side stackable on either straight or right-angle posted, unshrouded AMPMODU System 50 headers.
 2. For end-to-end stacking, the posts located between the adjoining housings must be removed to provide housing end clearance.

Typical Cable-to-Board Application of Plain Receptacle Housing

Typical Cable-to-Board Application of Latch Style Receptacle Housing

Note: All part numbers are RoHS compliant.

Double Row Receptacle Housings, .050 x .100 [1.27 x 2.54] Centerline, Cable-to-Board



Plain Style Housings



Latch Style Housings

Plain Style Housings

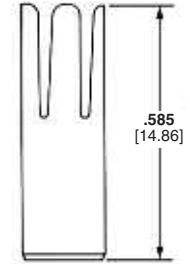
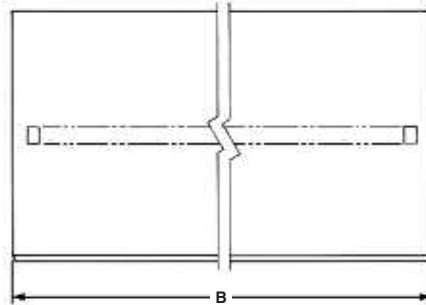

Plain

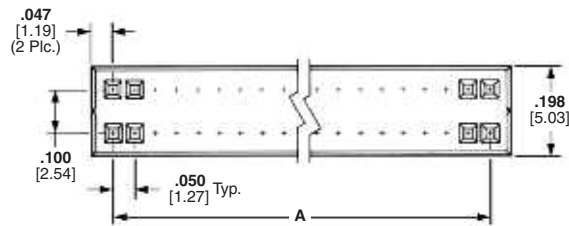

Material

Black thermoplastic, flame retardant, 94V-0 rated

Related Product Data

Performance Characteristics — page 63

Receptacle Contacts — page 48

Mateable Headers — pages 29, 30, 34, 35, & 44

Latch Style Housings

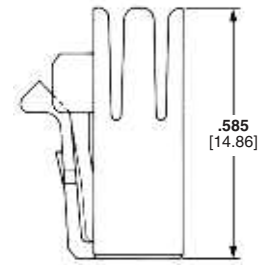
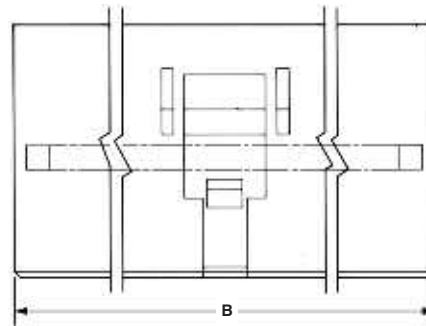

Latch

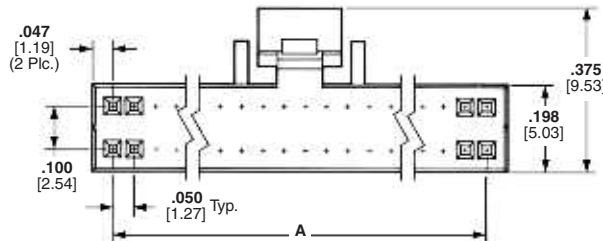

Technical Documents — page 64

Product Specification 108-16022

Application Specification 114-16008

Double Row Receptacle Housings, .050 x .100 [1.27 x 2.54] Centerline, Cable-to-Board (Continued)

| No. of Pos. | Dimensions | | Plain Housing Part Numbers | Latch Style Housing Part Numbers |
|-------------|---------------|---------------|----------------------------|----------------------------------|
| | A | B | | |
| 8 | .150 [3.81] | .247 [6.27] | 487938-8 | 487937-8 |
| 10 | .200 [5.08] | .297 [7.54] | 1-487938-0 | 1-487937-0 |
| 12 | .250 [6.35] | .374 [8.81] | 1-487938-2 | 1-487937-2 |
| 14 | .300 [7.62] | .397 [10.08] | 1-487938-4 | 1-487937-4 |
| 16 | .350 [8.89] | .447 [11.35] | 1-487938-6 | 1-487937-6 |
| 20 | .450 [11.43] | .547 [13.89] | 2-487938-0 | 2-487937-0 |
| 24 | .550 [13.97] | .647 [16.43] | 2-487938-4 | 2-487937-4 |
| 26 | .600 [15.24] | .697 [17.7] | 2-487938-6 | 2-487937-6 |
| 30 | .700 [17.78] | .797 [20.24] | 3-487938-0 | 3-487937-0 |
| 34 | .800 [20.32] | .897 [22.78] | 3-487938-4 | 3-487937-4 |
| 40 | .950 [24.13] | 1.047 [26.59] | 4-487938-0 | 4-487937-0 |
| 44 | 1.050 [26.67] | 1.147 [29.13] | 4-487938-4 | 4-487937-4 |
| 50 | 1.200 [30.48] | 1.297 [39.94] | 5-487938-0 | 5-487937-0 |
| 60 | 1.450 [36.83] | 1.547 [39.29] | — | 6-487937-0 |
| 72 | 1.750 [44.45] | 1.847 [46.91] | 7-487938-2 | 7-487937-2 |
| 80 | 1.950 [49.53] | 2.047 [51.99] | 8-487938-0 | 8-487937-0 |
| 100 | 2.450 [62.23] | 2.547 [64.69] | 487938-1 | 487937-1 |

Note: Other sizes of receptacle housings, up to 120 positions, can be made available, consult TE.

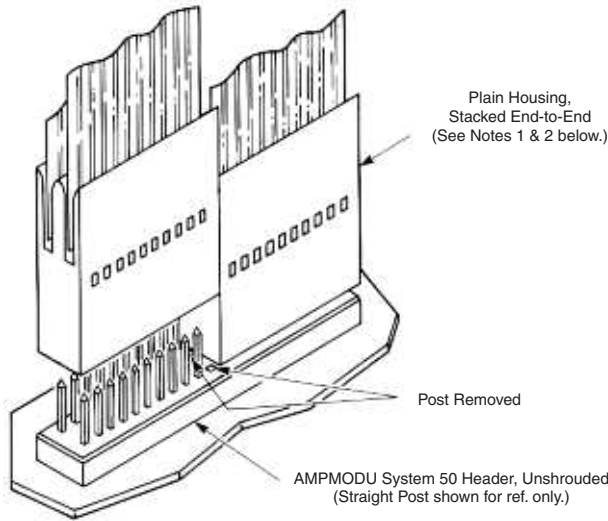

- Notes:**
1. Plain housings are end-to-end stackable on either straight or right-angle posted, unshrouded AMPMODU System 50 headers.
 2. For end-to-end stacking, the two posts located between the adjoining housings must be removed to provide housing end clearance.

Typical Cable-to-Board Application of Plain Receptacle Housing

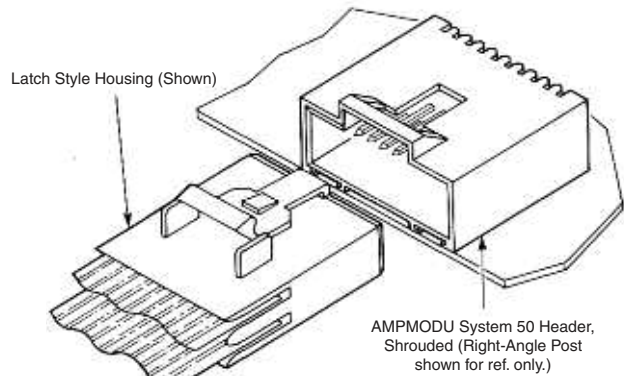

Typical Cable-to-Board Application of Latch Style Receptacle Housing

Note: All part numbers are RoHS compliant.

ZIF-Line Connectors, .050 x .100 [1.27 x 2.54] Centerline, Cable-to-Board

Vertical Cable Entry

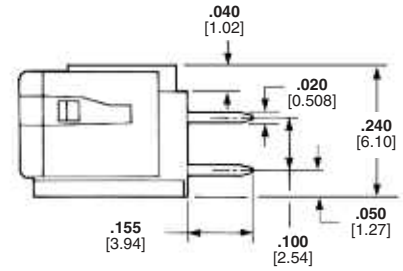
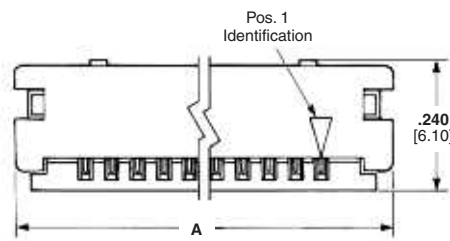

Material and Finish

Housing and Cover — Black thermoplastic, flame retardant, 94V-0 rated

Contacts — Phosphor bronze, plated .000150 [0.00381] min. bright tin over .000050 [0.00127] min. nickel on entire contact

Performance Characteristic

Contact Current Rating — 1 ampere†

†1 ampere rating is for single circuit. Multiple circuits, ambient temperature and conductor size affect current carrying capacity.

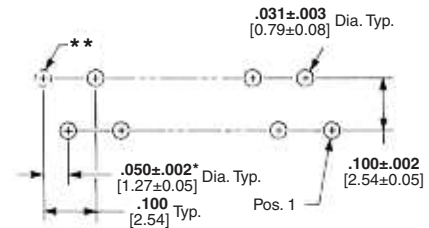
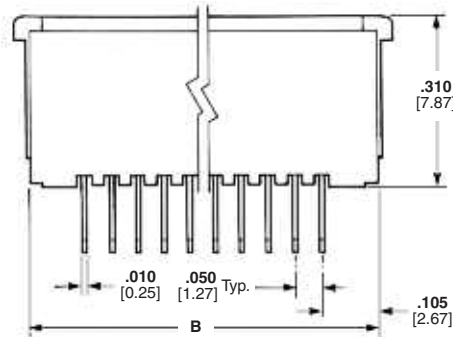

Recommended Mounting Hole Pattern

*±.002 [±0.05] tolerance not to accumulate within one mounting hole pattern.

**This mounting hole required for even-numbered connector sizes only.

Note: ZIF-Line connector illustrated above with cover in closed position.

Related Product Data

FFC Cable (with Tin-Plated Prepared Ends) — Consult TE.

Technical Documents — page 64

Product Specification 108-16025

Application Specification 114-16014

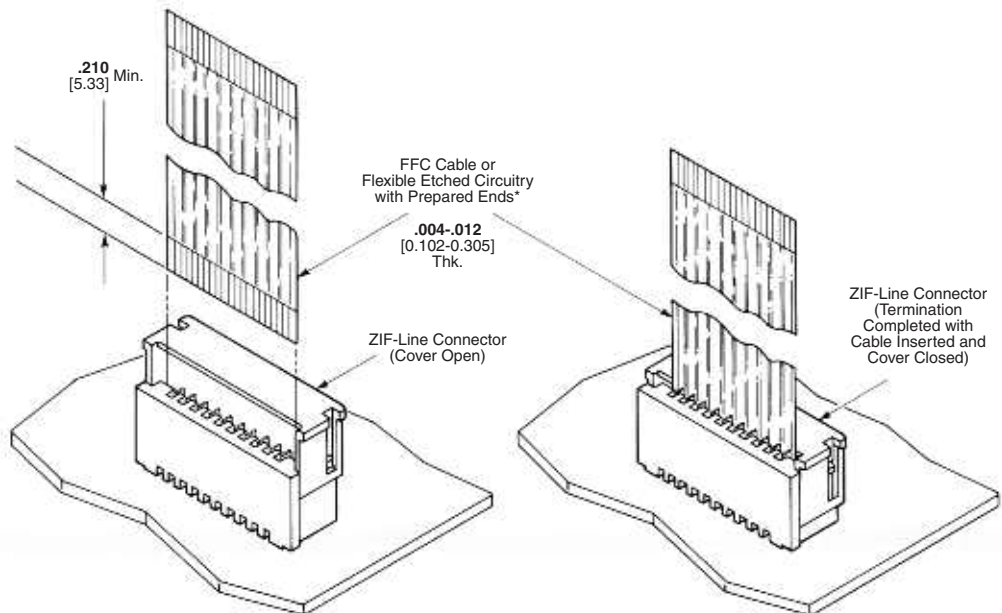

*FFC cable with tin-plated prepared ends can be made available, consult TE.

Note: Special preparation of cable is required, refer to TE Application Specification No. 114-16014.

Typical Flexible Flat Conductor Cable-to-Board Application

**ZIF-Line Connectors, .050 x .100 [1.27 x 2.54] Centerline,
Cable-to-Board (Continued)**

| No. of Pos. | Dimensions | | Connector Part Numbers |
|-------------|---------------|---------------|------------------------|
| | A | B | |
| 5 | .470 [11.94] | .410 [10.41] | 5-487576-0 |
| 6 | .520 [13.21] | .460 [11.68] | 5-487576-1 |
| 7 | .570 [14.48] | .510 [12.95] | 4-487576-8 |
| 8 | .620 [15.75] | .560 [14.22] | 4-487576-9 |
| 9 | .670 [17.02] | .610 [15.49] | 487576-1 |
| 10 | .720 [18.29] | .660 [16.76] | 487576-2 |
| 11 | .770 [19.56] | .710 [18.03] | 487576-3 |
| 12 | .820 [20.83] | .760 [19.30] | 487576-4 |
| 13 | .870 [22.10] | .810 [20.57] | 487576-5 |
| 14 | .920 [23.37] | .860 [21.84] | 487576-6 |
| 15 | .970 [24.64] | .910 [23.11] | 487576-7 |
| 16 | 1.020 [25.91] | .960 [24.38] | 487576-8 |
| 17 | 1.070 [27.18] | 1.010 [25.65] | 487576-9 |
| 18 | 1.120 [28.45] | 1.060 [26.92] | 1-487576-0 |
| 19 | 1.170 [29.72] | 1.110 [28.19] | 1-487576-1 |
| 20 | 1.220 [30.99] | 1.160 [29.46] | 1-487576-2 |
| 21 | 1.270 [32.26] | 1.210 [30.73] | 1-487576-3 |
| 22 | 1.320 [33.53] | 1.260 [32.00] | 1-487576-4 |
| 23 | 1.370 [34.80] | 1.310 [33.27] | 1-487576-5 |
| 24 | 1.420 [36.07] | 1.360 [34.54] | 1-487576-6 |
| 25 | 1.470 [37.34] | 1.410 [35.81] | 1-487576-7 |
| 26 | 1.520 [38.61] | 1.460 [37.08] | 1-487576-8 |
| 27 | 1.570 [39.88] | 1.510 [38.35] | 1-487576-9 |
| 28 | 1.620 [41.15] | 1.560 [39.62] | 2-487576-0 |
| 29 | 1.670 [42.42] | 1.610 [40.89] | 2-487576-1 |
| 30 | 1.720 [43.69] | 1.660 [42.16] | 2-487576-2 |

| No. of Pos. | Dimensions | | Connector Part Numbers |
|-------------|---------------|---------------|------------------------|
| | A | B | |
| 31 | 1.770 [44.96] | 1.710 [43.43] | 2-487576-3 |
| 32 | 1.820 [46.23] | 1.760 [44.70] | 2-487576-4 |
| 33 | 1.870 [47.50] | 1.810 [45.97] | 2-487576-5 |
| 34 | 1.920 [48.77] | 1.860 [47.24] | 2-487576-6 |
| 35 | 1.970 [50.04] | 1.910 [48.51] | 2-487576-7 |
| 36 | 2.020 [51.31] | 1.960 [49.78] | 2-487576-8 |
| 37 | 2.070 [52.58] | 2.010 [51.05] | 2-487576-9 |
| 38 | 2.120 [53.85] | 2.060 [52.32] | 3-487576-0 |
| 39 | 2.170 [55.12] | 2.110 [53.59] | 3-487576-1 |
| 40 | 2.220 [56.39] | 2.160 [54.86] | 3-487576-2 |
| 41 | 2.270 [57.66] | 2.210 [56.13] | 3-487576-3 |
| 42 | 2.320 [58.93] | 2.260 [57.40] | 3-487576-4 |
| 43 | 2.370 [60.20] | 2.310 [58.67] | 3-487576-5 |
| 44 | 2.420 [61.47] | 2.360 [59.94] | 3-487576-6 |
| 45 | 2.470 [62.74] | 2.410 [61.21] | 3-487576-7 |
| 46 | 2.520 [64.01] | 2.460 [62.48] | 3-487576-8 |
| 47 | 2.570 [65.28] | 2.510 [63.75] | 3-487576-9 |
| 48 | 2.620 [66.55] | 2.560 [65.02] | 4-487576-0 |
| 49 | 2.670 [67.82] | 2.610 [66.29] | 4-487576-1 |
| 50 | 2.720 [69.09] | 2.660 [67.56] | 4-487576-2 |
| 51 | 2.770 [70.36] | 2.710 [68.83] | 4-487576-3 |
| 52 | 2.820 [71.63] | 2.760 [70.10] | 4-487576-4 |
| 53 | 2.870 [72.90] | 2.810 [71.37] | 4-487576-5 |
| 54 | 2.920 [74.17] | 2.860 [72.64] | 4-487576-6 |
| 55 | 2.970 [75.44] | 2.910 [73.91] | 4-487576-7 |

Note: All part numbers are RoHS compliant.

Cable-to-Board Connectors, .050 x .100 [1.27 x 2.54] Centerline, Ribbon Cable, System 50

Product Facts

- Preassembled housing and cover
- One step termination
- End and daisy chain termination
- Positive end latching of connector to shrouded headers
- Terminates 30 AWG [0.05 mm²] solid or stranded and 32 AWG [0.03 mm²]* stranded .025 [0.64] centerline ribbon cable with PVC insulation
- 0.5 ampere current rating (limited by cable)

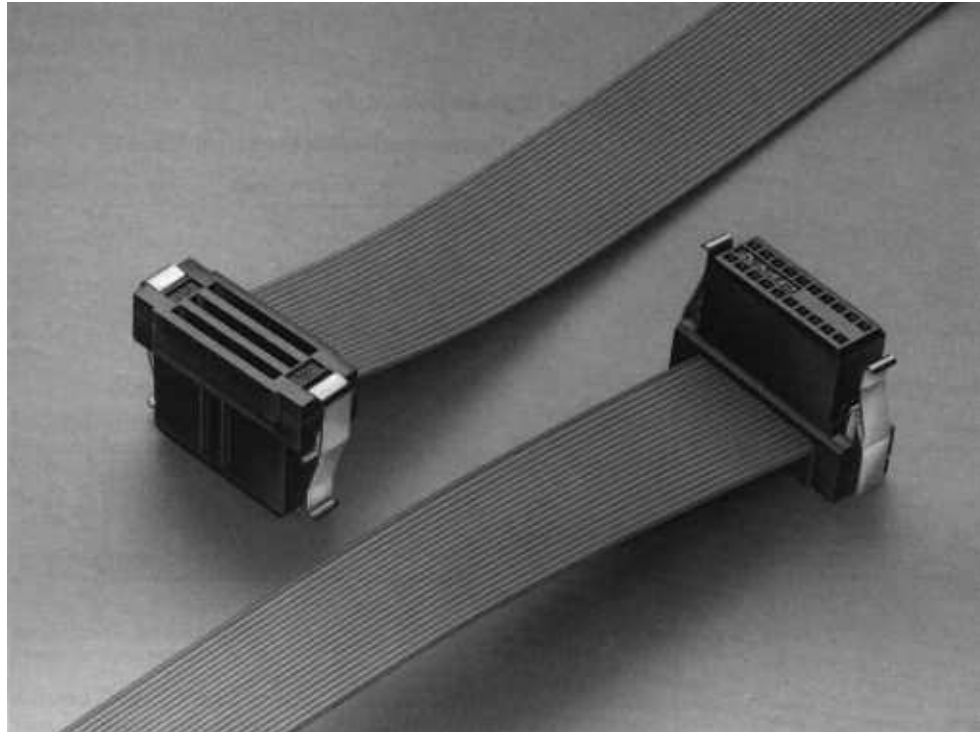

The AMP-LATCH System 50 Ribbon Cable connector is a receptacle connector that will terminate ribbon cable on .025 [0.64] centerlines. It is available in select sizes from 10 to 100 positions and will accommodate 30 AWG [0.05 mm²] solid or stranded and 32 AWG [0.03 mm²]

stranded conductors, with PVC cable insulation.

The housing and cover (black) have a 94V-0 rating. A copper alloy single mating beam contact provides the interconnect between the conductor and the .015 [0.38] square posts on the .050 x .100 [1.27 x 2.54] grid. The

contacts are plated with 30 gold duplex plating. The latching feature is located on the receptacle, not the header, and saves board space and eliminates future problems of "latch height compatibility."

Double Row Receptacles, .050 x .100 [1.27 x 2.54] Centerline, Cable-to-Board, Ribbon Cable, System 50

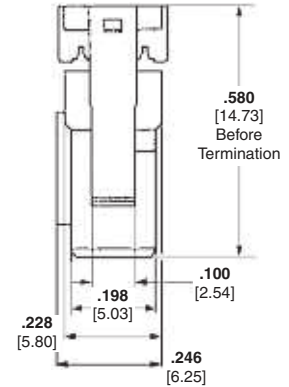
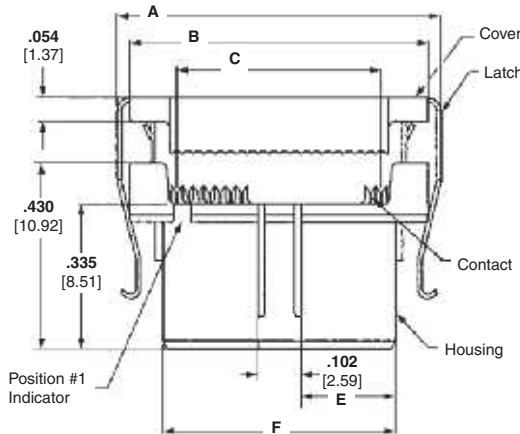
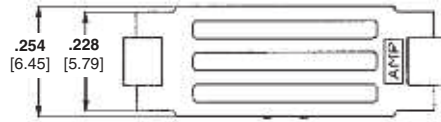

Material and Finish

Housing — Black thermoplastic, 94V-0 rated

Latches — Stainless steel

Contacts — Copper alloy, plated gold over nickel with tin in termination area

Related Product Data

Performance Characteristics — page 63

Mateable Headers — pages 29, 30, 34, 35 & 44

Application Tooling — page 60-62

Mates with Posts — .015 [0.38] square, .125 [3.18] long, on .050 x .100 [1.27 x 2.54] grid

Technical Documents — page 64

Product Specification 108-1109

Application Specification 114-25029

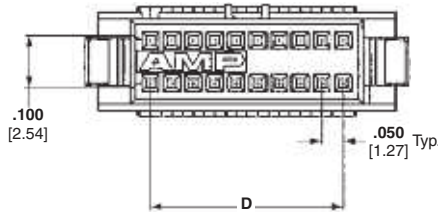

| No. of Pos. | Dimensions | | | | | | Part Numbers |
|-------------|---------------|---------------|---------------|---------------|---------------|---------------|--------------|
| | A | B | C | D | E | F | |
| 10 | .510 [12.95] | .445 [11.30] | .225 [5.72] | .200 [5.08] | .096 [2.44] | .294 [7.47] | 2-111196-5 |
| 14 | .610 [15.49] | .545 [13.84] | .325 [8.26] | .300 [7.62] | .146 [3.71] | .394 [10.01] | 2-111196-6 |
| 16 | .660 [16.76] | .595 [15.11] | .375 [9.52] | .350 [8.89] | .171 [4.34] | .444 [11.28] | 2-111196-7 |
| 20 | .760 [19.30] | .695 [17.65] | .475 [12.07] | .450 [11.43] | .221 [5.61] | .544 [13.82] | 1-111196-8 |
| 24 | .860 [20.32] | .795 [20.19] | .575 [14.61] | .550 [13.97] | .271 [6.88] | .644 [16.36] | 2-111196-8 |
| 26 | .910 [23.11] | .845 [21.46] | .625 [15.88] | .600 [15.24] | .296 [7.52] | .694 [17.63] | 2-111196-9 |
| 30 | 1.010 [25.65] | .945 [24.00] | .725 [18.42] | .700 [17.78] | .346 [8.79] | .794 [20.17] | 1-111196-9 |
| 34 | 1.110 [28.19] | 1.045 [26.54] | .825 [20.96] | .800 [20.32] | .396 [10.06] | .894 [22.71] | 3-111196-0 |
| 40 | 1.260 [32.00] | 1.195 [30.35] | .975 [24.81] | .950 [24.13] | .471 [11.96] | 1.044 [26.52] | 2-111196-0 |
| 44 | 1.360 [34.54] | 1.295 [32.89] | 1.075 [27.31] | 1.050 [26.67] | .521 [13.23] | 1.144 [29.06] | 3-111196-1 |
| 50 | 1.510 [38.35] | 1.445 [36.70] | 1.225 [31.12] | 1.200 [30.48] | .596 [15.14] | 1.294 [32.87] | 2-111196-1 |
| 60 | 1.760 [44.70] | 1.695 [43.05] | 1.475 [37.47] | 1.450 [36.83] | .721 [18.31] | 1.544 [39.22] | 2-111196-2 |
| 64 | 1.860 [47.24] | 1.795 [45.59] | 1.575 [40.00] | 1.550 [39.37] | .771 [19.58] | 1.644 [41.76] | 3-111196-2 |
| 68 | 1.960 [49.78] | 1.895 [48.13] | 1.675 [42.55] | 1.650 [41.91] | .821 [20.85] | 1.744 [44.30] | 3-111196-4 |
| 72 | 2.060 [52.32] | 1.995 [50.67] | 1.775 [45.08] | 1.750 [44.45] | .871 [22.12] | 1.844 [46.84] | 2-111196-3 |
| 80 | 2.260 [57.40] | 2.195 [55.75] | 1.975 [50.17] | 1.950 [49.53] | .971 [24.66] | 2.044 [51.92] | 3-111196-3 |
| 100 | 2.760 [70.10] | 2.695 [68.45] | 2.475 [62.87] | 2.450 [62.23] | 1.221 [31.01] | 2.544 [64.62] | 2-111196-4 |

Note: All part numbers are RoHS compliant.

Paddleboard Receptacles, .050 x .100 [1.27 x 2.54] Centerline, Cable-to-Board, Ribbon Cable, System 50

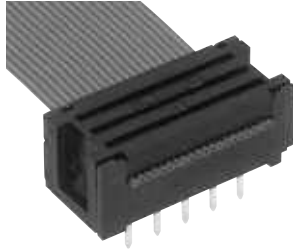

Material and Finish

Housing — Black LCP thermoplastic, 94V-0 rated

Cover — Black polyester, 94V-0 rated

Contacts — Copper alloy, plated .000100-.000200 [0.00245-0.00508] bright tin over .000050-.000100 [0.00127-0.00254] nickel

Related Product Data

Performance Characteristics — page 63

Application Tooling — pages 60-62

Technical Documents — page 64

Product Specification 108-1109

Application Specification 114-25040

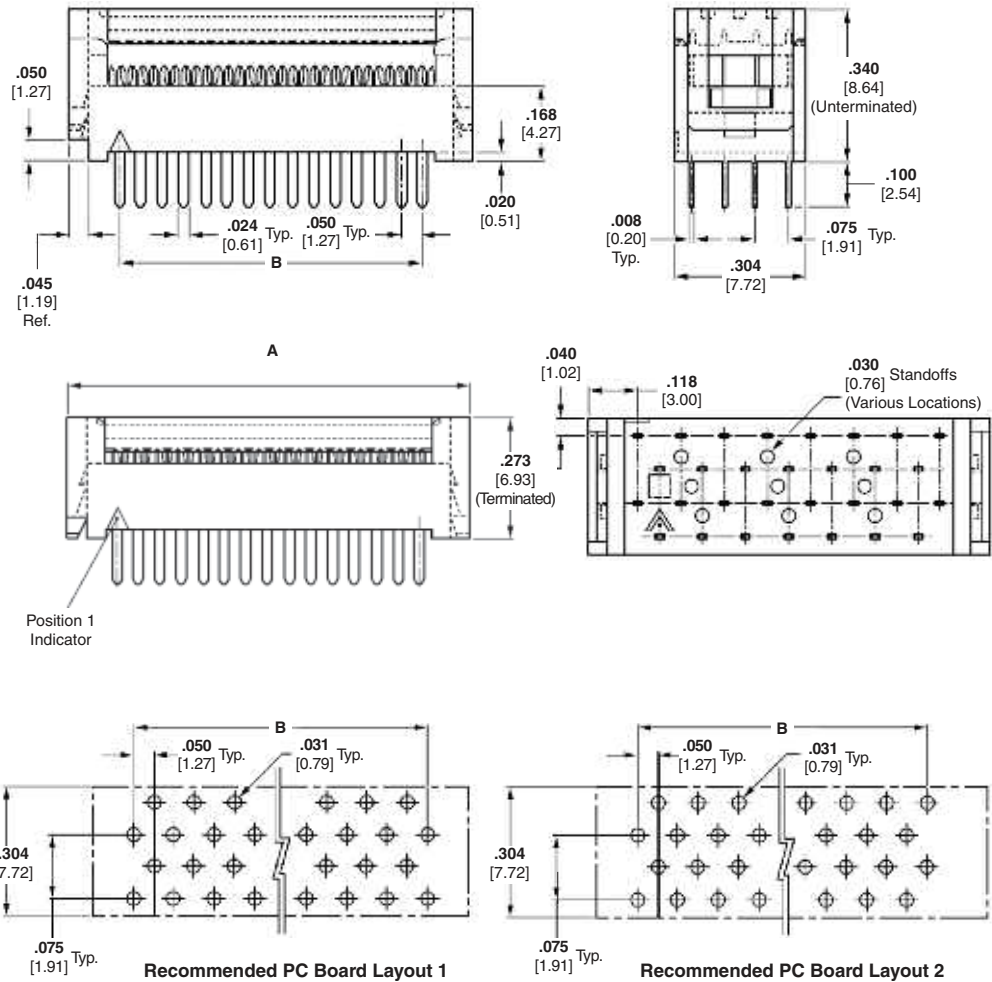

| No. of Pos. | PCB Hole Layout | Dimensions | | Part Numbers |
|-------------|-----------------|---------------|--------------|--------------|
| | | A | B | |
| 10 | 1 | .436 [11.07] | .200 [5.08] | 5111595-1 |
| 14 | 1 | .536 [13.61] | .300 [7.62] | 5111595-2 |
| 16 | 2 | .586 [14.88] | .350 [8.89] | 5111595-3 |
| 20 | 2 | .686 [17.42] | .450 [11.43] | 5111595-4 |
| 24 | 2 | .786 [19.96] | .550 [13.97] | 5111595-5 |
| 26 | 1 | .836 [21.23] | .600 [15.24] | 5111595-6 |
| 28 | 2 | .886 [22.50] | .650 [16.51] | 2-5111595-0 |
| 30 | 1 | .936 [23.77] | .700 [17.78] | 5111595-7 |
| 34 | 1 | 1.036 [26.31] | .800 [20.32] | 5111595-8 |
| 40 | 2 | 1.186 [30.12] | .950 [24.13] | 5111595-9 |

| No. of Pos. | PCB Hole Layout | Dimensions | | Part Numbers |
|-------------|-----------------|---------------|---------------|--------------|
| | | A | B | |
| 44 | 2 | 1.286 [32.66] | 1.050 [26.67] | 1-5111595-0 |
| 46 | 1 | 1.336 [33.93] | 1.100 [27.94] | 1-5111595-7 |
| 50 | 1 | 1.436 [36.47] | 1.200 [30.48] | 1-5111595-1 |
| 60 | 2 | 1.686 [42.82] | 1.450 [36.83] | 1-5111595-2 |
| 64 | 2 | 1.786 [45.36] | 1.550 [39.37] | 1-5111595-3 |
| 68 | 2 | 1.886 [47.90] | 1.650 [41.91] | 1-5111595-9 |
| 72 | 2 | 1.986 [50.44] | 1.750 [44.45] | 1-5111595-4 |
| 80 | 2 | 2.186 [55.52] | 1.950 [49.53] | 1-5111595-5 |
| 100 | 2 | 2.686 [68.22] | 2.450 [62.23] | 1-5111595-6 |

Note: All part numbers are RoHS compliant.

Flat Ribbon Cable, PVC Insulation

**30 AWG [0.05 mm²],
Solid Bare Copper**

Product Specifications

Voltage — 150 Volts

Impedance — 80 Ohms Nominal
(GND, SIG, GND, applies to 30AWG
Solid Bare Copper)

Capacitance — 19.2 pf/ft at
1 MHz nom.

Propagation Delay — 1.51 ns/ft nom.

Crosstalk —

10 ft sample 5 ns rise time:

Near End — 4.0% max.

Far End — 6.0% max.

UL Listing — STYLE 2678

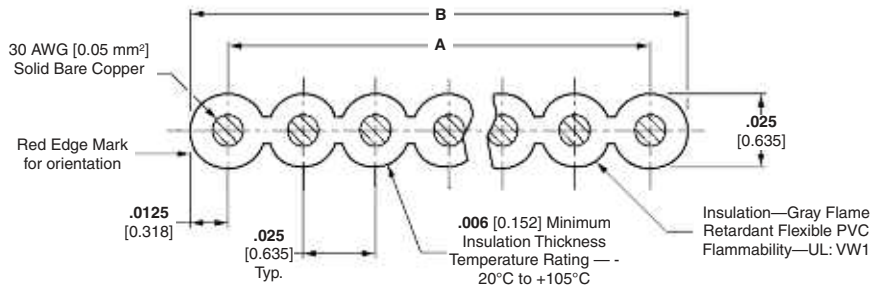

| No. of Conductors | Dimensions | | Part Numbers | |
|----------------------|---------------|---------------|-------------------|-------------------|
| | A | B | Length Per Reel* | |
| | | | 100 ft. [30.48 m] | 500 ft. [152.4 m] |
| 16 | .375 [9.52] | .400 [10.16] | 5-57013-1 | 5-57013-2 |
| 20 | .475 [12.07] | .500 [12.70] | 1-57013-3 | 57013-1 |
| 24 | .575 [14.61] | .600 [15.24] | 1-57013-4 | 57013-8 |
| 26 | .625 [15.88] | .650 [16.51] | 2-57013-5 | 2-57013-6 |
| 28 | .675 [17.14] | .700 [17.78] | 4-57013-6 | 4-57013-7 |
| 30 | .725 [18.42] | .750 [19.05] | 1-57013-5 | 57013-6 |
| 34 | .825 [20.95] | .850 [21.59] | 4-57013-9 | 5-57013-0 |
| 36 | .875 [22.23] | .900 [22.86] | 1-57013-6 | 57013-7 |
| 40 | .975 [24.77] | 1.000 [25.40] | 1-57013-7 | 57013-2 |
| 44 | 1.075 [27.31] | 1.100 [27.94] | 1-57013-8 | 57013-9 |
| 50 | 1.225 [27.94] | 1.250 [31.75] | 1-57013-9 | 1-57013-0 |
| 60 | 1.475 [37.47] | 1.500 [38.10] | 2-57013-0 | 57013-3 |
| 68 | 1.675 [42.55] | 1.700 [43.18] | 2-57013-1 | 1-57013-1 |
| 72 | 1.775 [45.09] | 1.800 [45.72] | 2-57013-2 | 1-57013-2 |
| 80 | 1.975 [50.17] | 2.000 [50.80] | 2-57013-3 | 57013-4 |
| 100 | 2.475 [62.87] | 2.500 [63.50] | 2-57013-4 | 57013-5 |

*Reel may contain separate lengths, 20 ft. [6.1 m] min. per length.

Recognized under the
Component Program of
Underwriters
Laboratories Inc.,
File No. E53793



Certified by Canadian
Standards Association,
(CSA File No. LL83498)



Electrical Characteristics of .025 [0.64] Centerline IDC Ribbon Cable

| Base Part No. | Insulation | AWG | Voltage | Impedance Single Ended G-S-G | Capacitance Nominal G-S-G | Inductance Nominal | Nominal Prop. Delay | NEXT 10 Ft 5ns Rise Time | FEXT 10 Ft 5ns Rise Time |
|---------------------|------------|-------------|---------|------------------------------|---------------------------|--------------------|---------------------|--------------------------|--------------------------|
| 57013 | PVC | 30 Solid | 150 Vac | 80 Ohms Nom | 19.2 pf/ft | .160 mh/ft | 1.51 ns/ft | 4.0% Max | 6.0% Max |
| 219054, 219137 | TPE | 30 Solid | 150 Vac | 90+/- 6 Ohms | 15.3 pf/ft | .124 mh/ft | 1.382 ns/ft | 2.39% Nom | 2.99% Nom |
| 57119, 57139, 57145 | FEP | 30 Solid | 300 Vac | 93 Ohms Nom | 13.6 pf/ft | .120 mn/ft | 1.34 ns/ft | 2.6% Nom | 2.8% Nom |
| 57131 | PVC | 30 Stranded | 150 VAC | 66 Ohms Nom | 23.0 pf/ft | .100 mh/ft | 1.55 ns/ft | 2.8% Max | 4.5% Max |
| 219055 | TPE | 30 Stranded | 150 VAC | 78 Ohms Nom | 19.4 pf/ft | .118 mh/ft | 1.510 ns/fr | 1.37% Nom | 2.37% Nom |
| 57288, 57289, 57290 | FEP | 30 Stranded | 300 Vac | 85 Ohms Nom | 15.4 pf/ft | .110 mh/ft | 1.36 ns/ft | 2.5% Nom | 2.8% Nom |
| 219253 | TPE | 31 Stranded | 150 Vac | 90+/- 6 Ohms | 15.4 pf/ft | .125 mh/ft | 1.527 ns/ft | 1.97% Nom | 2.51% Nom |
| 57038 | PVC | 32 Stranded | 150 Vac | 80 Ohms Nom | 19.2 pf/ft | .147 mh/ft | 1.51 ns/ft | 4.0% Max | 6.0% Max |
| 219138 | TPE | 32 Stranded | 150 Vac | 104 Ohms Nom | 12.8 pf/ft | .138 mh/ft | 1.664 ns/ft | 2.10% Nom | 2.57% Nom |
| 57118, 57138, 57144 | FEP | 32 Stranded | 300 Vac | 105 Ohms Nom | 13.0 pf/ft | .120 mh/ft | 1.36 ns/ft | 2.6% Nom | 2.8% Nom |

Note: All part numbers are RoHS compliant.

Centerline IDC Ribbon Cable, PVC Insulation

30 AWG 7/38 Stranded Tinned Copper

For use with:

AMP-LATCH System 50, AMPLIMITE .050 Series and AMPMODU System 50 Connectors

Compatible with:

AMP R-CAM Ribbon Cable Assembly Machine

Product Specifications

Voltage Rating — 150 Volts

Impedance — 66 ohms (GND, SIG, GND)

Capacitance — 23 pf/ft. at 1 KHz

Propagation Delay —

1.55 ns/ft. [5.6 ns/m]

Crosstalk —

10 Ft. sample 5 ns rise time

Near End — 2.8% max

Near End — 4.5% max

UL AWM Style 2678

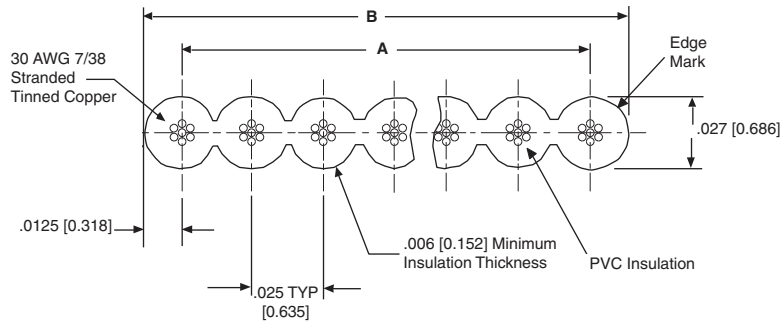

| No. of Conductors | Dimensions | | Part Numbers | |
|-------------------|---------------|---------------|------------------|-------------------|
| | A | B | Length Per Reel | |
| | | | 100 ft. [30.5 m] | 500 ft. [152.4 m] |
| 20 | .475 [12.07] | .500 [12.70] | 1-57131-3 | 57131-1 |
| 40 | .975 [24.77] | 1.000 [25.40] | 1-57131-7 | 57131-2 |
| 50 | 1.225 [31.12] | 1.250 [31.75] | 1-57131-9 | 1-57131-0 |
| 68 | 1.675 [42.55] | 1.700 [43.18] | 2-57131-1 | 1-57131-1 |
| 80 | 1.975 [50.17] | 2.000 [50.80] | 2-57131-3 | 57131-4 |
| 100 | 2.475 [62.87] | 2.500 [63.50] | 2-57131-4 | 57131-5 |

Flat Ribbon Cable

3

Note: All part numbers are RoHS compliant.

Application Tooling for Flexible Film Contacts

Hand Crimping Tool Assemblies (for repair purposes)



Part No. 90273-5—for .100 C Multi-Crimp Contacts (408-9564)

Extraction Tools for .100 C Contacts

Tool No. 91200-□*— for Receptacle Housings with **Side Locking Lance Slot** (408-7916)

Tool No. 91047-□*— for Receptacle and Pin Housings with **End Locking Lance Slot** (408-7384)

*Consult TE for specific dash nos.

For tooling information, contact the Technical Support Center:
1-800-522-6752.

Flexible Film Termination Machine (Terminates Continuous Strip Contacts Sequentially)

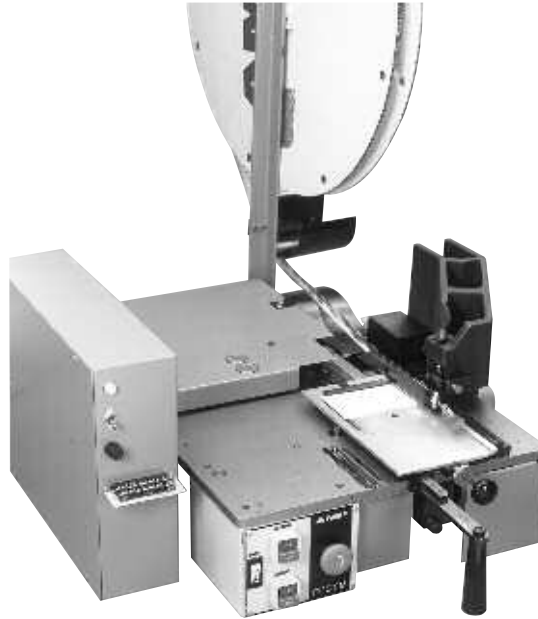

The flexible film semiautomatic bench machine for terminating .050 [1.27] and .100 [2.54] centerline flexible flat conductor cable (FFC), flexible etched circuitry (FEC), and flexible printed wiring (FPW) with AMP FFC reel-mounted contacts. For each cable or circuitry, the contacts are automatically applied one-at-a-time in a straight sequence. To skip positions, an optional programmer control box is available. Crimp height is easily adjustable in .0002 [.0051] increments. Termination rates up to 200 contacts per minute.

| Description | Machine Part Numbers | |
|---|----------------------|--------------------------|
| | Machine | Machine With Programmer* |
| .100 [2.54] C , Multi-Crimp, 120 V | 224910-1 | 318619-1 |
| .100 [2.54] C , Multi-Crimp, 240 V | 224910-2 | 318619-2 |
| .100 [2.54] C , ARINC, 120 V | 224910-3 | 318619-3 |
| .050 [1.27] C , Multi-Crimp, 120 V | 224910-4 | 318619-4 |
| .050 [1.27] C , Multi-Crimp, 240 V | 224910-6 | 318619-6 |

*The Programmer Kit (**Part No. 356484-1**) may be purchased with a new machine, or separately for adding onto an existing machine.

Technical Documents

Customer Manuals
409-5835 (Part Numbers 224910 and 318619)
409-5880 Programmer Kit (Part Number 356484-1)

Specifications

Width — 20.5 [520]
Depth — 27.5 [700]
Height — 18 [460] (with reel support)
Reel Size — 24 [610] (max.)
Weight — 100 lb. [45.4 kg]
Electrical Source —
120 VAC, 50/60 Hz, 7.0 A;
240 VAC, 50/60 Hz, 3.5 A

Note: All part numbers are RoHS compliant.

Application Tooling for Compliant Pin Connectors

ASG Servo Electric Presses for Compliant Pin Connectors

TE offers the ASG line of servo electric presses for the application of compliant pin products. Systems are available in a wide range of pressing forces, board size capabilities and automation levels to meet almost any applications requirements. Each system utilizes a servo electric motor with PC control. Coupled with force and distance monitoring and control, the entire line provides 100% quality assurance in real-time with SPC data collection capabilities. Automatic set up and a graphical operator interface help provide intuitive operation to help reduce common and costly operator errors.

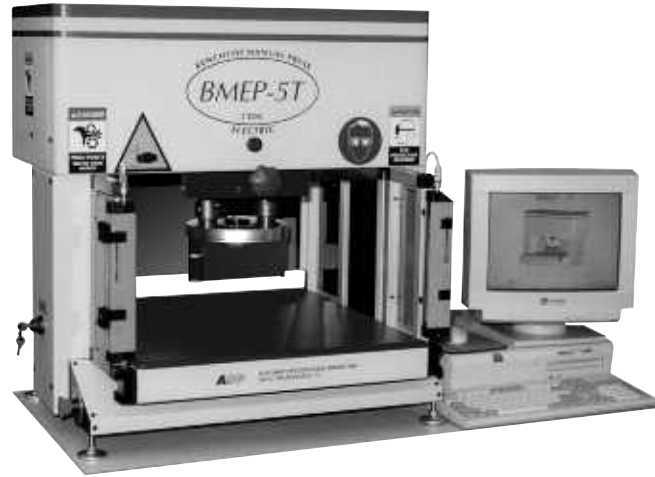

Press Force Monitoring for Scrap Avoidance

Every TE ASG servo press utilizes real-time force and distance monitoring and control. This allows the press to identify an error and react throughout the press stroke. Common problems such as PCB holes above/below specification and sometimes bent pins can be detected by monitoring both minimum

and maximum force parameters. Common operator error such as improperly placed connectors, missing\incorrect connector or tooling can also be found by monitoring premature or missing force parameters. In each case, the system can stop during the press cycle to avoid costly scrap and rework.

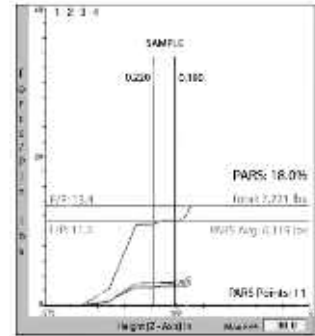

Product Line Overview



| | BMEP | MEP | AEP 6T | AEP 12T |
|-----------------------|-------------------------------|----------------------------------|------------------------------|---------------------------------------|
| System Type | Benchtop Semi-Automatic Press | Stand-Alone Semi-Automatic Press | Stand-Alone Automatic Press | Stand-Alone or Inline Automatic Press |
| Force Capability | Up to 5 Tons [44 kN] | Up to 12 Tons [107 kN] | Up to 6 Tons [53 kN] | Up to 12 Tons [107 kN] |
| Board Size Capability | Up to 18" x 24" [460x610 mm] | Up to 30" x 36" [760x915 mm] | Up to 30" x 36" [760x915 mm] | Up to 36" x 48" [915x1220 mm] |

Please contact the Tyco Tooling Assistance Center at 1-800-722-1111 for help with choosing the correct press and tooling to meet your application needs. See Catalog 1309329 for more information on this equipment.

Note: All part numbers are RoHS compliant.

Application Tooling for Ribbon Cable Connectors

These application tools are designed for one-step termination of ribbon cable connectors to planar, ground plane and shielded/jacketed ribbon cable on .025 [0.64] centers. A complete set of tooling consists of an Arbor Tool (manual, Part No. 91085-2 or pneumatic, Part No. 91112-3), a Base Assembly, Part No. 768338-4 and a Connector Specific Kit, Part No. 679167-1 (receptacle).



Pneumatic Auto-Cycle Tool Part No. 91112-3



Manual Arbor Tool Part No. 91085-2

Technical Documents

Instruction Sheets

408-7777 — Manual Arbor Frame Assembly

408-6732 — Pneumatic Auto-Cycle Assembly

408-9827 — Universal Base Assembly, Arbor Tool

408-9872 — Connector Specific Kit for Receptacle Connectors (.025 [0.64] Centerline Cable)

408-9928 — Connector Specific Kit for Paddleboard Connectors (.025 [0.64] Centerline Cable)

Note: Tooling is available for other manufacturers' manual arbor tools. For information contact the TE Technical Support Center: 1-800-522-6752

Note: All part numbers are RoHS compliant.

Performance Specifications

Board-to-Board Spacing for Thru-Hole and Surface-Mount Connector Combinations

Thru-Hole Receptacle-Thru-Hole Header

(Single and Double Row, Shrouded and Unshrouded)

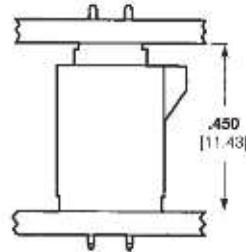

Thru-Hole Receptacle-Surface-Mount Header

(Double Row, Shrouded)

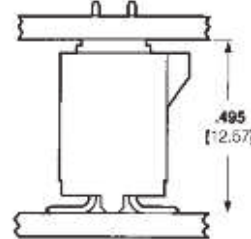

Surface-Mount Receptacle-Thru-Hole Header

(Double Row, Shrouded and Unshrouded)

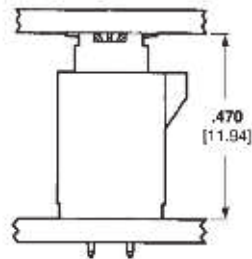

Surface-Mount Receptacle-Surface-Mount Header

(Double Row, Shrouded)

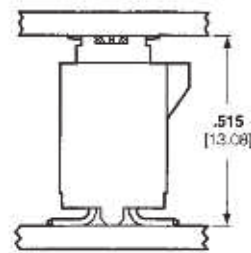

Need more information?

Call the Technical Support Center: **1-800-522-6752**. The Technical Support Center is staffed with specialists well versed in all TE products. The Center can provide you with:

- Technical Support
- Catalogs
- Technical Documents
- Product Samples
- TE Authorized Distributor Locations

Performance Specifications

| Description | Board-to-Board, Thru-Hole Headers and Receptacles | Board-to-Board, Surface-Mount, Headers and Receptacles | Cable-to-Board, .050 [1.27] Centerline FFC Cable Receptacles | Cable-to-Board, .025 [0.64] Centerline Ribbon Cable Receptacles |
|-------------------------------------|---|--|--|---|
| Size Range-Single Row Double Row | 4 thru 50 10 thru 100 | — 10 thru 100 | 4 thru 50 8 thru 100 | — 10 thru 100 |
| Current Rating (per contact) | 1.0 amperes | 1.0 amperes | 1.5 amperes | 0.5 amperes |
| Dielectric Withstanding Voltage | 500 VAC | 500 VAC | 300 VAC | 200 VAC |
| Insulation Resistance | 5,000 Megohms | 5,000 Megohms | 5,000 Megohms | 5,000 Megohms |
| Durability (tested to) | 200 Cycles | 200 Cycles | 200 Cycles | 150 Cycles |
| Mating Force (per contact) | 5 oz. [1.38 N] Max. | 5 oz. [1.38 N] Max. | 8 oz. [2.22 N] Max. | 4 oz. [1.11 N] Max. |
| Unmating Force (per contact) | 0.8 oz. [0.22 N] Min. | 0.8 oz. [0.22 N] Min. | 1.0 oz. [0.27 N] Min. | *0.5 oz. [0.13 N] Min. |
| Operating Temperature | -65°C to +105°C | -65°C to +105°C | -55°C to +105°C | -65°C to +105°C |

*With latches depressed.

Technical Documents

The following is a list of technical documents covering the application, performance and maintenance of AMPMODU System 50 connectors.

Product Specifications describe technical performance characteristics and verification tests. They are intended for the Design, Component and Quality Engineer.

- 108-1093—AMPMODU System 50 Interconnection System, Board-to-Board
- 108-1109—AMPLATCH System 50 Receptacle and Paddleboard Connector
- 108-16022—Connector System, .050 [1.27] Centerline FFC Cable
- 108-16025—Connector, ZIF-Line 50
- 108-16029—Shielded Flexible Flat Conductor Cable
- 108-40002—Flexible Flat Conductor Cable

Application Specifications describe requirements for using the product in its intended application and/or crimping information. They are intended for the Packaging and Design Engineer and the Machine Setup Person.

- 114-16008—Multiple Crimp Contact for .050 [1.27] Centerline FFC and FEC Cable
- 114-16014—AMP ZIF-Line 50 & 100 PCB Connectors
- 114-25029—AMPMODU System 50 Ribbon Cable Connectors
- 114-25031—AMPMODU System 50 Thru-Hole Connectors
- 114-25035—AMPMODU Surface-Mount Connectors
- 114-25040—AMPMODU System 50 Paddleboard Connectors



Instruction Sheets provide instructions for assembling or applying the product. They are intended for the Manufacturing Assembler or Operator.

- 408-6732—Pneumatic Arbor Tool, Part Number 91112-3 (Auto-Cycle)
- 408-7384—Extraction Tool, Part Number 91047
- 408-7763—Pneumatic Arbor Tool, Part Number 91112-2
- 408-7777—Manual Arbor Tool, Part Number 91085-2
- 408-7916—Extraction Tool, Part Number 91200
- 408-9827—Universal Base Assembly, Arbor Tool, Part Number 768338-1
- 408-9872—Connector Specific Kit, Part Number 679167-1, AMPMODU System 50 Receptacle Connectors (.025 [0.64] Centerline Cable)
- 408-9928—Connector Specific Kit, Part Number 679176-1, AMPMODU System 50 Paddleboard Connectors (.025 [0.64] Centerline Cable)
- 408-9564—Hand Crimping Tool Assembly, Part Number 90273-5
- 408-9719—FFC Contact Positioning Hand Tool Kit, Part Number 91292-1

Note: All part numbers are RoHS compliant.

AMPMODU 2mm Connectors (Board to Board)

Product Facts

- 2.0 x 2.0 [.08 x .08] centerline spacing
- Two-piece, double-row connector system
- Unshrouded header styles include; breakaway and surface-mount
- All headers with 0.5 [.02] square posted contacts
- Surface-mount connectors compatible with standard surface-mount processing (VPR, IR)
- Closed top-entry receptacle assemblies include; vertical mount and right-angle
- Receptacle contacts employ dual cantilever beams for two-point electrical stability
- Duplex (gold/tin-lead) plated posted contacts and receptacle contacts
- Thermoplastic housing material, UL 94V-0 rated
- Recognized under the Component Program of Underwriters Laboratories Inc., File No. E28476 
- Certified by Canadian Standards Association, File No. LR7189 
- Produced under a Quality Management System certified to ISO 9001

A copy of the certificate is available upon request.

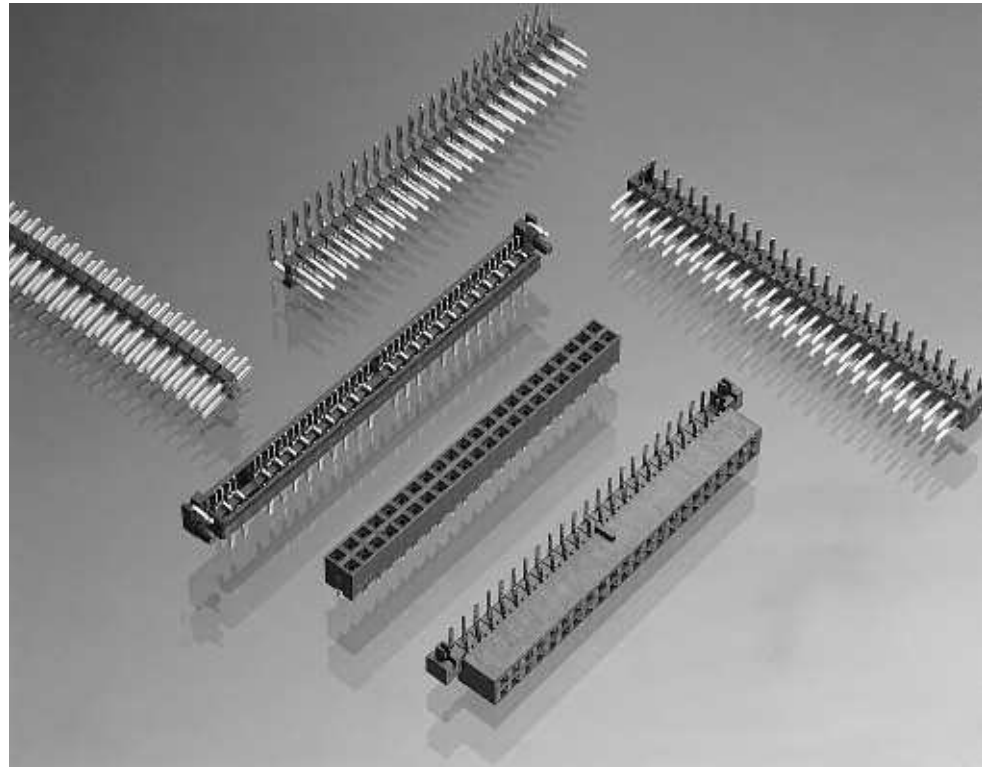

AMPMODU 2mm connectors reliably and economically meet the packaging and inter-connection requirements of today's miniature sophisticated electronics. They are ideal for mobile and portable personal computers and disk drive applications. In today's marketplace, 2mm is expanding over many other industry segments due to space constraints.

This versatile double-row connector system is comprised of various straight and right-angle posted headers for thru-hole and surface mounting and several closed top-entry receptacle assemblies for vertical and horizontal mounting. Headers and receptacle assemblies are available in selected sizes ranging from 4 through 80 positions.

Thru-hole breakaway headers feature brass straight or right-angle posts with a post length of 4.0 [.16] and a lead length of 2.6 [.10].

The receptacle assemblies employ phosphor bronze contacts with dual cantilever beams and built-in anti-overstress. This feature, coupled with duplex (gold/tin-lead) plating of the header posts and receptacle contacts, provide superior electrical performance as well as excellent solderability.

2mm Headers, Unshrouded, Double Row, Thru-Hole, Vertical Mount

0.5 [.02] Square Straight Posts

Material and Finish

Housing — Black thermoplastic, UL 94V-0 Rated

Posted Contacts — Copper alloy, duplex plated as follows:
0.00020 [.000008] min. gold on contact area, 0.00254 [.000100] min. tin on solder area, with entire contact underplated 0.00127 [.000050] min. nickel

Related Product Data

Mateable Receptacles — pages 80-84

Product Specification
108-57197

Packaging Method — Loose piece, bag

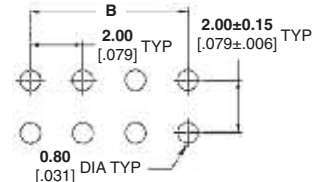
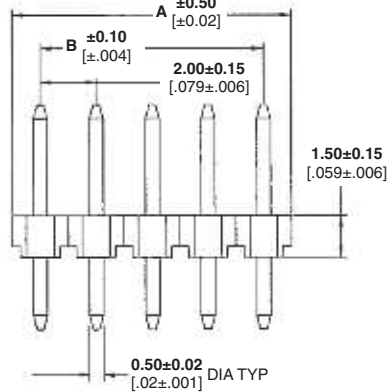
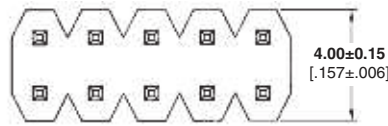

Recommended Solder Pad Layout

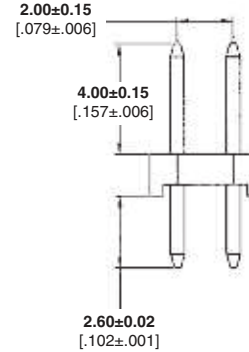

| Position | Dimensions | | Part Numbers | |
|----------|-------------|-------------|--------------|-------------|
| | A | B | Reflow | |
| | | | 240°C | 265°C |
| 4 | 4.0 [.16] | 2.0 [.08] | 1470213-4 | 1734508-4 |
| 6 | 6.0 [.24] | 4.0 [.16] | 1470213-6 | 1734508-6 |
| 8 | 8.0 [.32] | 6.0 [.24] | 1470213-8 | 1734508-8 |
| 10 | 10.0 [.39] | 8.0 [.32] | 1-1470213-0 | 1-1734508-0 |
| 12 | 12.0 [.47] | 10.0 [.39] | 1-1470213-2 | 1-1734508-2 |
| 14 | 14.0 [.55] | 12.0 [.47] | 1-1470213-4 | 1-1734508-4 |
| 16 | 16.0 [.63] | 14.0 [.55] | 1-1470213-6 | 1-1734508-6 |
| 18 | 18.0 [.71] | 16.0 [.63] | 1-1470213-8 | 1-1734508-8 |
| 20 | 20.0 [.79] | 18.0 [.71] | 2-1470213-0 | 2-1734508-0 |
| 22 | 22.0 [.87] | 20.0 [.79] | 2-1470213-2 | 2-1734508-2 |
| 24 | 24.0 [.94] | 22.0 [.87] | 2-1470213-4 | 2-1734508-4 |
| 26 | 26.0 [1.02] | 24.0 [.94] | 2-1470213-6 | 2-1734508-6 |
| 28 | 28.0 [1.10] | 26.0 [1.02] | 2-1470213-8 | 2-1734508-8 |
| 30 | 30.0 [1.18] | 28.0 [1.10] | 3-1470213-0 | 3-1734508-0 |
| 32 | 32.0 [1.26] | 30.0 [1.18] | 3-1470213-2 | 3-1734508-2 |
| 34 | 34.0 [1.34] | 32.0 [1.26] | 3-1470213-4 | 3-1734508-4 |
| 36 | 36.0 [1.42] | 34.0 [1.34] | 3-1470213-6 | 3-1734508-6 |
| 38 | 38.0 [1.50] | 36.0 [1.42] | 3-1470213-8 | 3-1734508-8 |
| 40 | 40.0 [1.57] | 38.0 [1.50] | 4-1470213-0 | 4-1734508-0 |
| 42 | 42.0 [1.65] | 40.0 [1.57] | 4-1470213-2 | 4-1734508-2 |
| 44 | 44.0 [1.73] | 42.0 [1.65] | 4-1470213-4 | 4-1734508-4 |
| 46 | 46.0 [1.81] | 44.0 [1.73] | 4-1470213-6 | 4-1734508-6 |
| 48 | 48.0 [1.89] | 46.0 [1.81] | 4-1470213-8 | 4-1734508-8 |
| 50 | 50.0 [1.97] | 48.0 [1.89] | 5-1470213-0 | 5-1734508-0 |
| 52 | 52.0 [2.05] | 50.0 [1.97] | 5-1470213-2 | 5-1734508-2 |
| 54 | 54.0 [2.13] | 52.0 [2.05] | 5-1470213-4 | 5-1734508-4 |
| 56 | 56.0 [2.20] | 54.0 [2.13] | 5-1470213-6 | 5-1734508-6 |
| 58 | 58.0 [2.28] | 56.0 [2.20] | 5-1470213-8 | 5-1734508-8 |
| 60 | 60.0 [2.36] | 58.0 [2.28] | 6-1470213-0 | 6-1734508-0 |
| 62 | 62.0 [2.44] | 60.0 [2.36] | 6-1470213-2 | 6-1734508-2 |
| 64 | 64.0 [2.52] | 62.0 [2.44] | 6-1470213-4 | 6-1734508-4 |
| 66 | 66.0 [2.60] | 64.0 [2.52] | 6-1470213-6 | 6-1734508-6 |
| 68 | 68.0 [2.68] | 66.0 [2.60] | 6-1470213-8 | 6-1734508-8 |
| 70 | 70.0 [2.76] | 68.0 [2.68] | 7-1470213-0 | 7-1734508-0 |
| 72 | 72.0 [2.83] | 70.0 [2.76] | 7-1470213-2 | 7-1734508-2 |
| 74 | 74.0 [2.91] | 72.0 [2.83] | 7-1470213-4 | 7-1734508-4 |
| 76 | 76.0 [2.99] | 74.0 [2.91] | 7-1470213-6 | 7-1734508-6 |
| 78 | 78.0 [3.07] | 76.0 [2.99] | 7-1470213-8 | 7-1734508-8 |
| 80 | 80.0 [3.15] | 78.0 [3.07] | 8-1470213-0 | 8-1734508-0 |

Note: All part numbers are RoHS compliant.

Breakaway Headers, Unshrouded, Double Row, Thru-Hole Mount

4

2mm Headers, Unshrouded, Double Row, Thru-Hole, Right-Angle Mount

0.5 [.02] Square Straight Posts

Material and Finish

Housing — Black thermoplastic, UL 94V-0 Rated, 265°C Process Capable

Posted Contacts — Copper alloy, duplex plated as follows:
0.00020 [.000008] min. gold on contact area, 0.00254 [.000100] min. tin on solder area, with entire contact underplated 0.00127 [.000050] min. nickel

Related Product Data

Mateable Receptacles — pages 80-84

Product Specification
108-57197

Packaging Method — Loose piece, bag

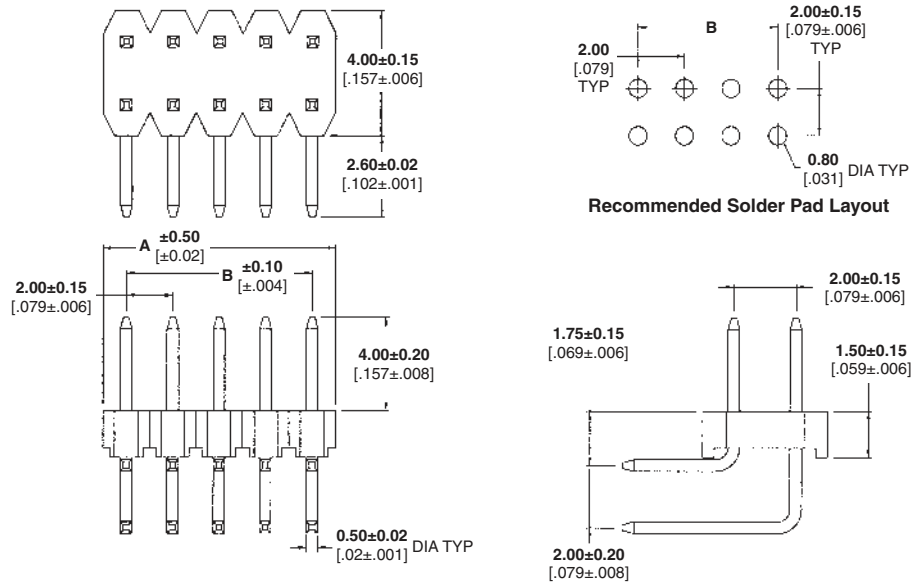

| Position | Dimensions | | Part Numbers |
|----------|-------------|-------------|--------------|
| | A | B | |
| 4 | 4.0 [0.16] | 2.0 [0.08] | 1734507-4 |
| 6 | 6.0 [0.24] | 4.0 [0.16] | 1734507-6 |
| 8 | 8.0 [0.31] | 6.0 [0.24] | 1734507-8 |
| 10 | 10.0 [0.39] | 8.0 [0.31] | 1-1734507-0 |
| 12 | 12.0 [0.47] | 10.0 [0.39] | 1-1734507-2 |
| 14 | 14.0 [0.55] | 12.0 [0.47] | 1-1734507-4 |
| 16 | 16.0 [0.63] | 14.0 [0.55] | 1-1734507-6 |
| 18 | 18.0 [0.71] | 16.0 [0.63] | 1-1734507-8 |
| 20 | 20.0 [0.79] | 18.0 [0.71] | 2-1734507-0 |
| 22 | 22.0 [0.87] | 20.0 [0.79] | 2-1734507-2 |
| 24 | 24.0 [0.94] | 22.0 [0.87] | 2-1734507-4 |
| 26 | 26.0 [1.02] | 24.0 [0.94] | 2-1734507-6 |
| 28 | 28.0 [1.10] | 26.0 [1.02] | 2-1734507-8 |
| 30 | 30.0 [1.18] | 28.0 [1.10] | 3-1734507-0 |
| 32 | 32.0 [1.26] | 30.0 [1.18] | 3-1734507-2 |
| 34 | 34.0 [1.34] | 32.0 [1.26] | 3-1734507-4 |
| 36 | 36.0 [1.42] | 34.0 [1.34] | 3-1734507-6 |
| 38 | 38.0 [1.50] | 36.0 [1.42] | 3-1734507-8 |
| 40 | 40.0 [1.57] | 38.0 [1.50] | 4-1734507-0 |
| 42 | 42.0 [1.65] | 40.0 [1.57] | 4-1734507-2 |
| 44 | 44.0 [1.73] | 42.0 [1.65] | 4-1734507-4 |
| 46 | 46.0 [1.81] | 44.0 [1.73] | 4-1734507-6 |
| 48 | 48.0 [1.89] | 46.0 [1.81] | 4-1734507-8 |
| 50 | 50.0 [1.97] | 48.0 [1.89] | 5-1734507-0 |
| 52 | 52.0 [2.05] | 50.0 [1.97] | 5-1734507-2 |
| 54 | 54.0 [2.13] | 52.0 [2.05] | 5-1734507-4 |
| 56 | 56.0 [2.20] | 54.0 [2.13] | 5-1734507-6 |
| 58 | 58.0 [2.28] | 56.0 [2.20] | 5-1734507-8 |
| 60 | 60.0 [2.36] | 58.0 [2.28] | 6-1734507-0 |
| 62 | 62.0 [2.44] | 60.0 [2.36] | 6-1734507-2 |
| 64 | 64.0 [2.52] | 62.0 [2.44] | 6-1734507-4 |
| 66 | 66.0 [2.60] | 64.0 [2.52] | 6-1734507-6 |
| 68 | 68.0 [2.68] | 66.0 [2.60] | 6-1734507-8 |
| 70 | 70.0 [2.76] | 68.0 [2.68] | 7-1734507-0 |
| 72 | 72.0 [2.83] | 70.0 [2.76] | 7-1734507-2 |
| 74 | 74.0 [2.91] | 72.0 [2.83] | 7-1734507-4 |
| 76 | 76.0 [2.99] | 74.0 [2.91] | 7-1734507-6 |
| 78 | 78.0 [3.07] | 76.0 [2.99] | 7-1734507-8 |
| 80 | 80.0 [3.15] | 78.0 [3.07] | 8-1734507-0 |

Note: All part numbers are RoHS compliant.

2mm Breakaway Headers, Unshrouded, Double Row, Thru-Hole, Right-Angle Mount

0.5 [.02] Square Right-Angle Posts

Material and Finish

Housing — Black thermoplastic, UL 94V-0 rated

Posted Contacts — Brass, duplex plated as follows:

A — 0.00020 [.000008] min. gold on contact area, 0.00100 [.000039] min. tin on solder area, with entire contact underplated 0.00130 [.000051] min. nickel

B — 0.00076 [.000030] min. gold on contact area, 0.00100 [.000039] min. tin on solder area, with entire contact underplated 0.00130 [.000051] min. nickel

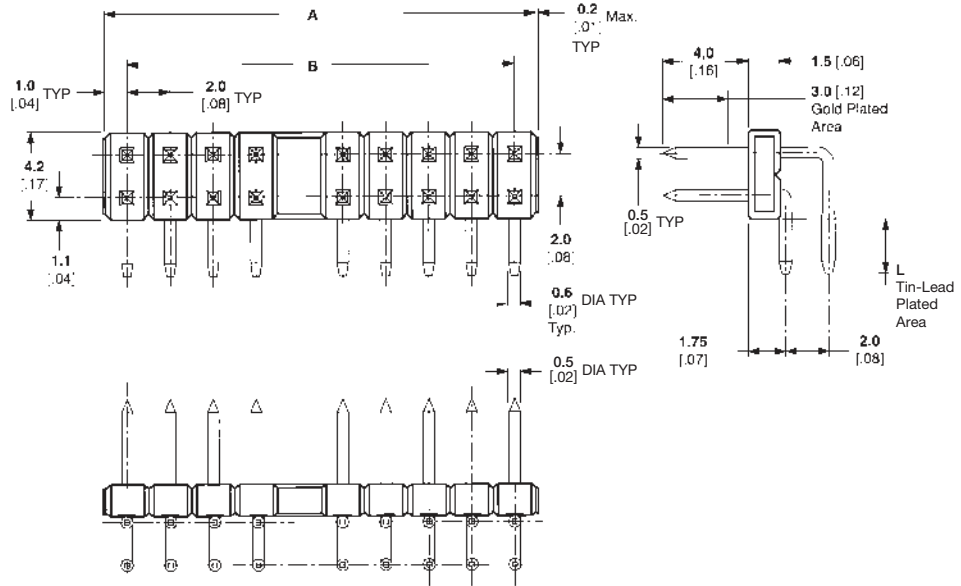

Related Product Data

Mateable Receptacles — pages 80-84

Product Specification 108-5296

Packaging Method — Loose piece, bag

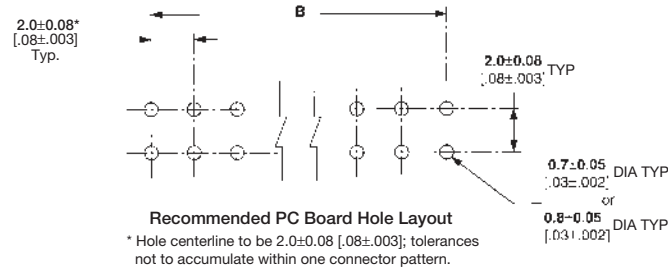

| No. of Positions | Dimensions | | Contact Plating Lead Length L = 2.6[.10]** | |
|------------------|-------------|-------------|---|-------------|
| | A | B | A | B |
| 4 | 4.0 [0.16] | 2.0 [0.08] | 5176837-1 | 2-5176837-5 |
| 6 | 6.0 [0.24] | 4.0 [0.16] | 5176837-2 | 2-5176837-6 |
| 8 | 8.0 [0.31] | 6.0 [0.24] | 5176837-3 | — |
| 10 | 10.0 [0.39] | 8.0 [0.31] | 5176837-4 | — |
| 12 | 12.0 [0.47] | 10.0 [0.39] | 5176837-5 | — |
| 14 | 14.0 [0.55] | 12.0 [0.47] | 5176837-6 | 3-5176837-0 |
| 16 | 16.0 [0.63] | 14.0 [0.55] | 5176837-7 | — |
| 18 | 18.0 [0.71] | 16.0 [0.63] | — | 3-5176837-2 |
| 20 | 20.0 [0.79] | 18.0 [0.71] | — | 3-5176837-3 |
| 22 | 22.0 [0.87] | 20.0 [0.79] | — | 3-5176837-4 |
| 26 | 26.0 [1.02] | 24.0 [0.94] | 1-5176837-2 | — |
| 30 | 30.0 [1.18] | 28.0 [1.10] | 1-5176837-4 | — |
| 32 | 32.0 [1.26] | 30.0 [1.18] | 1-5176837-5 | 3-5176837-9 |
| 34 | 34.0 [1.34] | 32.0 [1.26] | — | 4-5176837-0 |
| 36 | 36.0 [1.42] | 34.0 [1.34] | — | 4-5176837-1 |
| 38 | 38.0 [1.50] | 36.0 [1.42] | 1-5176837-8 | 4-5176837-2 |
| 40 | 40.0 [1.57] | 38.0 [1.50] | 1-5176837-9 | 5-5176837-2 |
| 42 | 42.0 [1.65] | 40.0 [1.57] | 2-5176837-0 | 4-5176837-4 |
| 44 | 44.0 [1.73] | 42.0 [1.65] | 2-5176837-1 | — |
| 46 | 46.0 [1.81] | 44.0 [1.73] | 2-5176837-2 | 4-5176837-6 |
| 48 | 48.0 [1.89] | 46.0 [1.81] | 2-5176837-3 | 4-5176837-7 |
| 50 | 50.0 [1.97] | 48.0 [1.89] | 2-5176837-4 | 4-5176837-8 |

4 Breakaway Headers, Unshrouded, Double Row, Thru-Hole Mount

2mm Breakaway Headers, Unshrouded, Double Row, Thru-Hole, Vertical Mount

0.5 [.02] Square Straight Posts

Material and Finish

Housing — Black thermoplastic, UL 94V-0 rated

Posted Contacts — Brass, duplex plated as follows:

Plating A — 0.00020 [.000008] min. gold on contact area, 0.00100 [.000039] min. tin on solder area, with entire contact underplated 0.00130 [.000051] min. nickel

Plating B — 0.00076 [.000030] min. gold on contact area, 0.00100 [.000039] min. tin on solder area, with entire contact underplated 0.00130 [.000051] min. nickel

Related Product Data

Mateable Receptacles — pages 80-84

Product Specification 108-5296

Packaging Method — Loose piece, bag

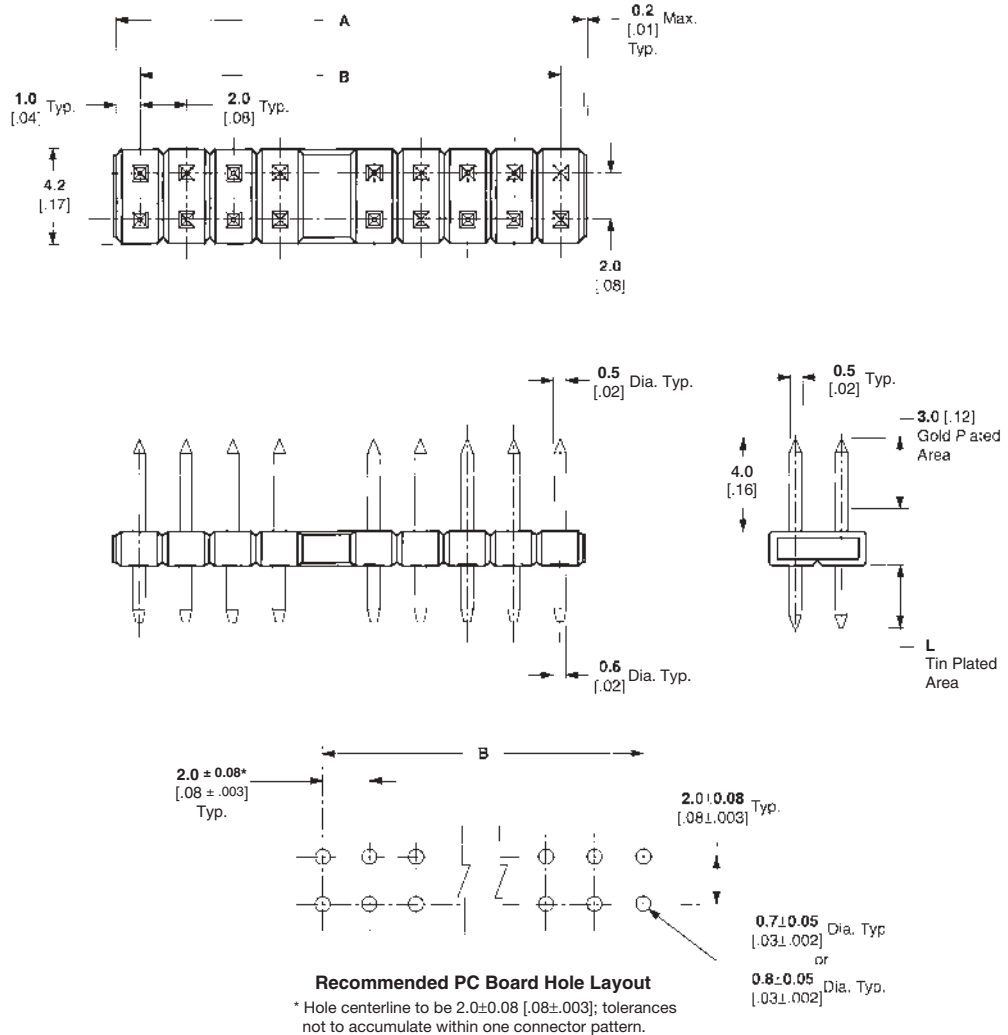

Breakaway Headers, Unshrouded, Double Row, Thru-Hole Mount

4

2mm Breakaway Headers, Unshrouded, Double Row, Thru-Hole, Vertical Mount (Continued)

0.5 [.02] Square Straight Posts

| No. of Positions | Dimensions | | Contact Plating | | | |
|------------------|-------------|-------------|---------------------------|-------------|---------------------------|-------------|
| | | | Lead Length L = 1.5 [.06] | | Lead Length L = 2.6 [.10] | |
| | A | B | Plating A | Plating B | Plating A | Plating B |
| 4 | 4.0 [0.16] | 2.0 [0.08] | 5178751-1 | 2-5178751-5 | 5176264-1 | 1-5176264-6 |
| 6 | 6.0 [0.24] | 4.0 [0.16] | — | 2-5178751-6 | 5176264-2 | 1-5176264-7 |
| 8 | 8.0 [0.31] | 6.0 [0.24] | — | 2-5178751-7 | 5176264-3 | 1-5176264-8 |
| 10 | 10.0 [0.39] | 8.0 [0.31] | 5178751-4 | 2-5178751-8 | 5176264-4 | 1-5176264-9 |
| 12 | 12.0 [0.47] | 10.0 [0.39] | — | 2-5178751-9 | 5176264-5 | 2-5176264-0 |
| 14 | 14.0 [0.55] | 12.0 [0.47] | 5178751-6 | 3-5178751-0 | 5176264-6 | 2-5176264-1 |
| 16 | 16.0 [0.63] | 14.0 [0.55] | — | 3-5178751-1 | 5176264-7 | 2-5176264-2 |
| 18 | 18.0 [0.71] | 16.0 [0.63] | 5178751-8 | 3-5178751-2 | 5176264-8 | 2-5176264-3 |
| 20 | 20.0 [0.79] | 18.0 [0.71] | 5178751-9 | 3-5178751-3 | 5176264-9 | 2-5176264-4 |
| 22 | 22.0 [0.87] | 20.0 [0.79] | 1-5178751-0 | 3-5178751-4 | 1-5176264-0 | 2-5176264-5 |
| 24 | 24.0 [0.94] | 22.0 [0.87] | 1-5178751-1 | 3-5178751-5 | 1-5176264-1 | 2-5176264-6 |
| 26 | 26.0 [1.02] | 24.0 [0.94] | 1-5178751-2 | 3-5178751-6 | — | — |
| 28 | 28.0 [1.10] | 26.0 [1.02] | — | 3-5178751-7 | 1-5176264-3 | — |
| 30 | 30.0 [1.18] | 28.0 [1.10] | 1-5178751-4 | 3-5178751-8 | 1-5176264-4 | 2-5176264-9 |
| 32 | 32.0 [1.26] | 30.0 [1.18] | 1-5178751-5 | 3-5178751-9 | 1-5176264-5 | — |
| 34 | 34.0 [1.34] | 32.0 [1.26] | 1-5178751-6 | 4-5178751-0 | — | 4-5176264-0 |
| 36 | 36.0 [1.42] | 34.0 [1.34] | 1-5178751-7 | 4-5178751-1 | 3-5176264-2 | 4-5176264-1 |
| 38 | 38.0 [1.50] | 36.0 [1.42] | 1-5178751-8 | 4-5178751-2 | 3-5176264-3 | — |
| 40 | 40.0 [1.57] | 38.0 [1.50] | 1-5178751-9 | 4-5178751-3 | 3-5176264-4 | — |
| 42 | 42.0 [1.65] | 40.0 [1.57] | 2-5178751-0 | 4-5178751-4 | — | — |
| 44 | 44.0 [1.73] | 42.0 [1.65] | 2-5178751-1 | 4-5178751-5 | 3-5176264-6 | 4-5176264-5 |
| 46 | 46.0 [1.81] | 44.0 [1.73] | 2-5178751-2 | 4-5178751-6 | — | 4-5176264-6 |
| 48 | 48.0 [1.89] | 46.0 [1.81] | 2-5178751-3 | 4-5178751-7 | — | 4-5176264-7 |
| 50 | 50.0 [1.97] | 48.0 [1.89] | 2-5178751-4 | 4-5178751-8 | 3-5176264-9 | 4-5176264-8 |

4 Breakaway Headers, Unshrouded, Double Row, Thru-Hole Mount

Note: All part numbers are RoHS compliant.

2mm Breakaway Headers, Unshrouded, Double Row, Surface Mount, Vertical Mount

0.5 [.02] Square Straight Posts

Material and Finish

Housing — Black polyphenylene sulfide, UL 94V-0 rated

Posted Contacts — Phosphor bronze, plated as follows, Duplex plated 0.00020 [.000008] min. gold on contact area, 0.00200 [.000079] min. tin on solder area, with entire contact underplated 0.00130 [.000051] min. nickel

Related Product Data

Mateable Receptacles — pages 80-84

Product Specification 108-51001

Packaging Method — Tape & Reel

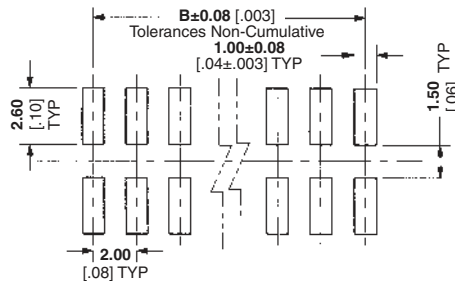
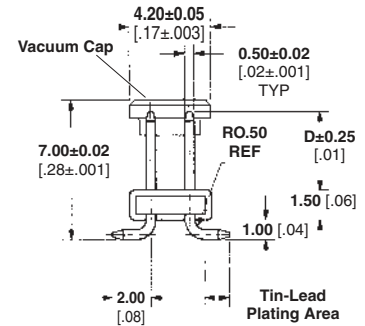
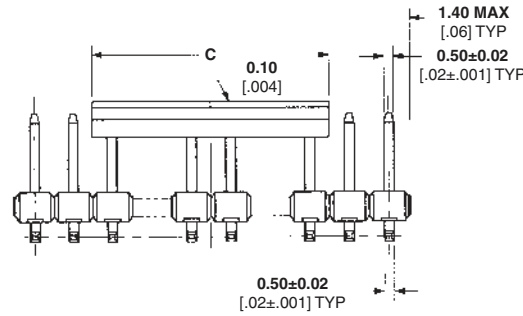
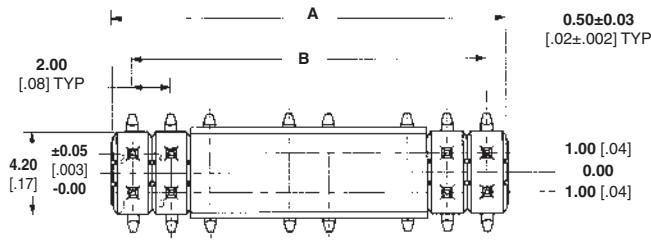

Recommended Solder Pad Layout

| No. of Positions | Dimensions | | | Part Numbers |
|------------------|-------------|-------------|------------|--------------|
| | A | B | C | |
| 4 | 4.0 [0.16] | 2.0 [0.08] | 4.0 [0.16] | 5084476-1 |
| 6 | 6.0 [0.24] | 4.0 [0.16] | 6.0 [0.24] | 5084476-2 |
| 12 | 12.0 [0.47] | 10.0 [0.39] | 5.0 [0.20] | 5084476-7 |
| 16 | 16.0 [0.63] | 14.0 [0.55] | 8.0 [0.31] | 5084476-3 |

Note: All part numbers are RoHS compliant.

2mm Breakaway Headers, Unshrouded, Double Row, Surface Mount, Vertical Mount (Continued)

0.5 [.02] Square Straight Posts

Material and Finish

Housing — Black polyphenylene sulfide, UL 94V-0 rated

Posted Contacts — Phosphor bronze, plated as follows, Duplex plated 0.0076 [.000030] min. gold on contact area, 0.00254-0.00406 [.000100-.000160] min. tin on solder area, with entire contact underplated 0.00127 [.000050] min. nickel

Related Product Data

Mateable Receptacles — pages 80-84

Product Specification 108-18544

Packaging Method — Tape & Reel

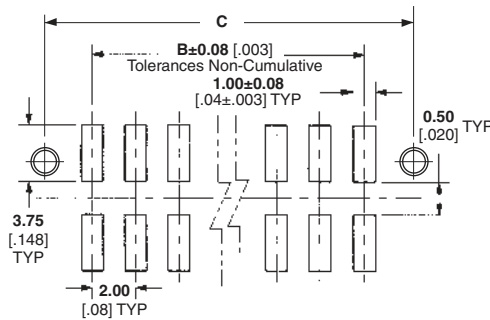
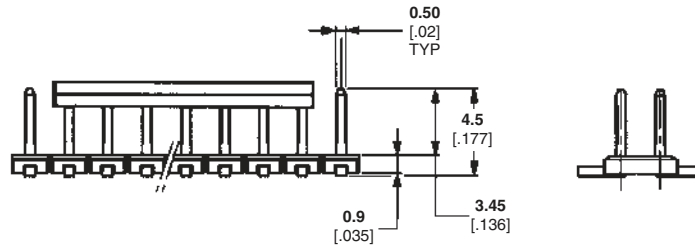
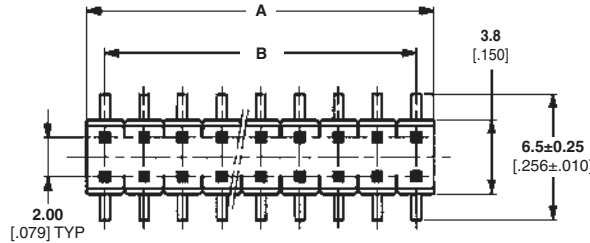

Recommended Solder Pad Layout

| No. of Positions | Dimensions | | | Part Numbers |
|------------------|-------------|-------------|--------------|--------------|
| | A | B | C | |
| 4 | 4.0 [0.16] | 2.0 [0.08] | 7.60 [0.30] | 966926-2 |
| 6 | 6.0 [0.24] | 4.0 [0.16] | 9.60 [0.38] | 966926-3 |
| 8 | 8.0 [0.31] | 6.0 [0.24] | 11.60 [0.46] | 966926-4 |
| 10 | 10.0 [0.39] | 8.0 [0.31] | 13.60 [0.53] | 966926-5 |
| 12 | 12.0 [0.47] | 10.0 [0.39] | 15.60 [0.61] | 966926-6 |
| 14 | 14.0 [0.55] | 12.0 [0.47] | 17.60 [0.69] | 966926-7 |
| 16 | 16.0 [0.63] | 14.0 [0.55] | 19.60 [0.77] | 966926-8 |
| 18 | 18.0 [0.71] | 16.0 [0.63] | 21.60 [0.85] | 966926-9 |
| 20 | 20.0 [0.79] | 18.0 [0.71] | 23.60 [0.93] | 1-966926-0 |
| 22 | 22.0 [0.87] | 20.0 [0.79] | 25.60 [1.01] | 1-966926-1 |
| 24 | 24.0 [0.94] | 22.0 [0.87] | 27.60 [1.09] | 1-966926-2 |

Note: All part numbers are RoHS compliant.

AMPMODU .025 Square Interconnection System

4

2mm Stacking Header, Unshrouded, Double Row, Thru-Hole, Vertical Mount

0.5 [.02] Square Straight Posts

12 Position
Part Number 1734770-1

Material and Finish

Housing — Black thermoplastic, UL 94 V-0 Rated

Posted Contacts — Copper alloy, duplex plated as follows:

Gold flash all over contact underplated 0.00127 [.000050] min. nickel

Related Product Data

Mateable Receptacles — pages 80-84

Product Specification 108-57331

Packaging Method — Loose piece, bag

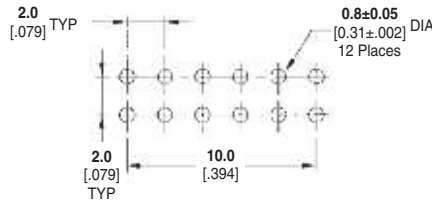
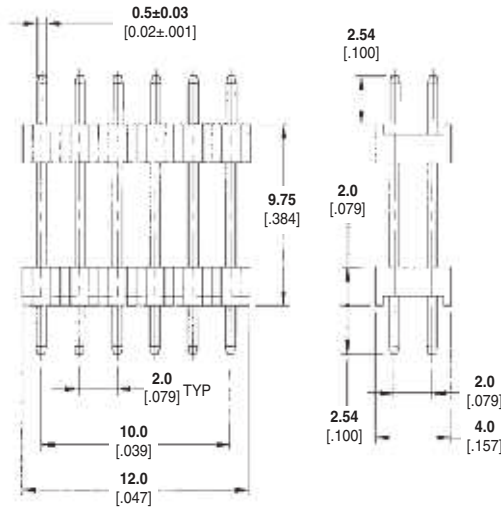

2.0 Pitch Vertical

4

Note: All part numbers are RoHS compliant.

2mm Headers, Shrouded, Double Row, Thru-Hole, Right-Angle Mount

0.5 [.02] Square Right-Angle Posts

**26 Position
Part Number 5084780-1**

Material and Finish

Housing — High temperature, black thermoplastic, UL 94 V-O Rated

Posted Contacts — Copper alloy, duplex plated as follows: 0.00038 [.00015] min. gold on contact area, 0.00254 [.000100] min. tin on solder area, with entire contact underplated 0.00127 [.000050] min. nickel

Related Product Data

Mateable Receptacles — pages 80 and 84

Product Specification
108-5296

Packaging Method — Tube

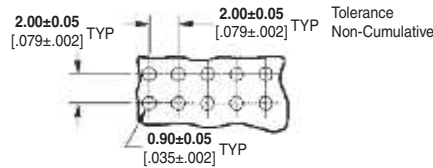
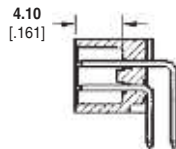
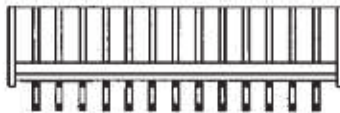
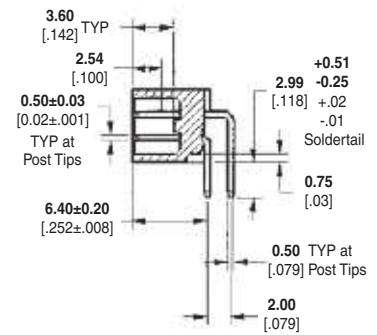
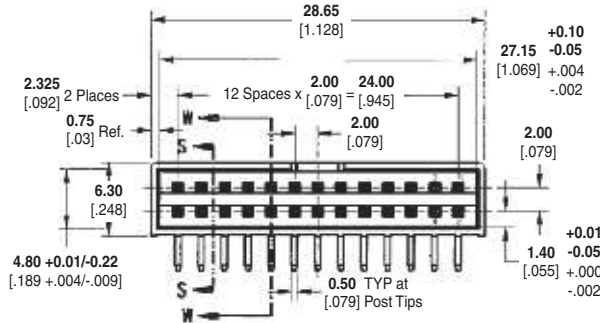
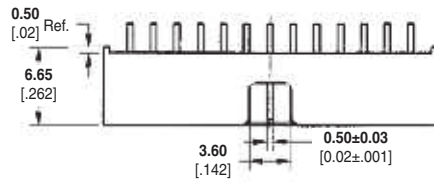

Recommended PCB Layout

Note: All part numbers are RoHS compliant.

2.0 Pitch Right-Angle

4

2mm Headers, Shrouded, Double Row, Thru-Hole, Right-Angle Mount

(Continued)

0.5 [0.02] Square Right-Angle Posts

Material and Finish

Housing — Natural color thermoplastic, UL 94 V-0 Rated

Posted Contacts — Brass, plated as follows:

0.00020 [0.00008] min. gold on contact area, with 0.00254 [0.00010] tin on soldertails, with entire contact underplated 0.00127 [0.00050] min. nickel

Related Product Data

Mateable Receptacles — pages 80 and 84

Product Specification 108-57197

Packaging Method — Tubes

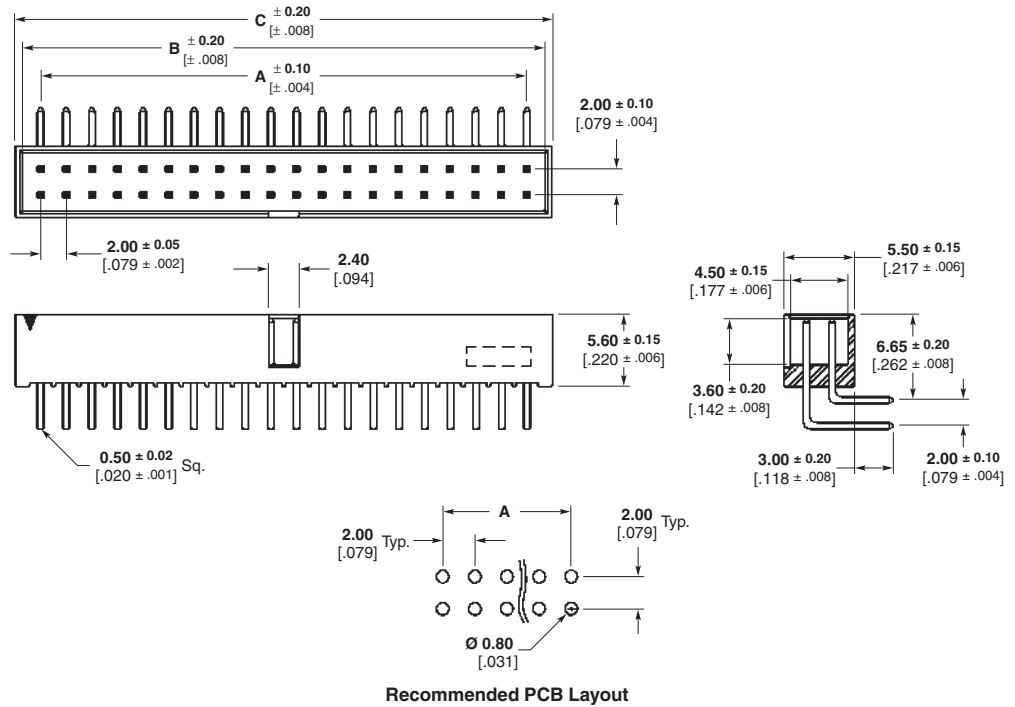

| No. of Positions | Dimensions | | | Part Numbers |
|------------------|-------------|--------------|--------------|--------------|
| | A | B | C | |
| 8 | 6.0 [0.24] | 8.85 [0.35] | 9.95 [0.39] | 1734493-8 |
| 10 | 8.0 [0.31] | 10.85 [0.43] | 11.95 [0.47] | 1-1734493-0 |
| 12 | 10.0 [0.39] | 12.85 [0.51] | 13.95 [0.55] | 1-1734493-2 |
| 14 | 12.0 [0.47] | 14.85 [0.58] | 15.95 [0.63] | 1-1734493-4 |
| 16 | 14.0 [0.55] | 16.85 [0.66] | 17.95 [0.71] | 1-1734493-6 |
| 18 | 16.0 [0.63] | 18.85 [0.74] | 19.95 [0.79] | 1-1734493-8 |
| 20 | 18.0 [0.71] | 20.85 [0.82] | 21.95 [0.86] | 2-1734493-0 |
| 22 | 20.0 [0.79] | 22.85 [0.90] | 23.95 [0.94] | 2-1734493-2 |
| 24 | 22.0 [0.87] | 24.85 [0.98] | 25.95 [1.02] | 2-1734493-4 |
| 26 | 24.0 [0.94] | 26.85 [1.06] | 27.95 [1.10] | 2-1734493-6 |
| 28 | 26.0 [1.02] | 28.85 [1.14] | 29.95 [1.18] | 2-1734493-8 |
| 30 | 28.0 [1.10] | 30.85 [1.21] | 31.95 [1.26] | 3-1734493-0 |
| 32 | 30.0 [1.18] | 32.85 [1.29] | 33.95 [1.34] | 3-1734493-2 |
| 34 | 32.0 [1.26] | 34.85 [1.37] | 35.95 [1.42] | 3-1734493-4 |
| 36 | 34.0 [1.34] | 36.85 [1.45] | 37.95 [1.49] | 3-1734493-6 |
| 38 | 36.0 [1.42] | 38.85 [1.53] | 39.95 [1.57] | 3-1734493-8 |
| 40 | 38.0 [1.50] | 40.85 [1.61] | 41.95 [1.65] | 4-1734493-0 |
| 42 | 40.0 [1.57] | 42.85 [1.69] | 43.95 [1.73] | 4-1734493-2 |
| 44 | 42.0 [1.65] | 44.85 [1.77] | 45.95 [1.81] | 4-1734493-4 |
| 46 | 44.0 [1.73] | 46.85 [1.84] | 47.95 [1.89] | 4-1734493-6 |
| 48 | 46.0 [1.81] | 48.85 [1.92] | 49.95 [1.97] | 4-1734493-8 |
| 50 | 48.0 [1.89] | 50.85 [2.00] | 51.95 [2.05] | 5-1734493-0 |
| 52 | 50.0 [1.97] | 52.85 [2.08] | 53.95 [2.12] | 5-1734493-2 |
| 54 | 52.0 [2.05] | 54.85 [2.16] | 55.95 [2.20] | 5-1734493-4 |
| 56 | 54.0 [2.13] | 56.85 [2.24] | 57.95 [2.28] | 5-1734493-6 |
| 58 | 56.0 [2.20] | 58.85 [2.32] | 59.95 [2.36] | 5-1734493-8 |
| 60 | 58.0 [2.28] | 60.85 [2.40] | 61.95 [2.44] | 6-1734493-0 |
| 62 | 60.0 [2.36] | 62.85 [2.47] | 63.95 [2.52] | 6-1734493-2 |
| 64 | 62.0 [2.44] | 64.85 [2.55] | 65.95 [2.60] | 6-1734493-4 |

Note: All part numbers are RoHS compliant.

2mm Headers, Shrouded, Double Row, Surface Mount, Vertical Mount

0.5 [.02] Square Posts

Material and Finish

Housing — Black color, PA9T (Nylon 9T), UL 94 V-0 Rated

Posted Contacts — Brass, plated as follows:

0.00076 [.000003] min. gold on contact area, with 0.00254 [.00010] matte tin on soldertails, with entire contact underplated 0.00127 [.000050] min. nickel

Related Product Data

Mateable Receptacles — pages 80, 81, and 84

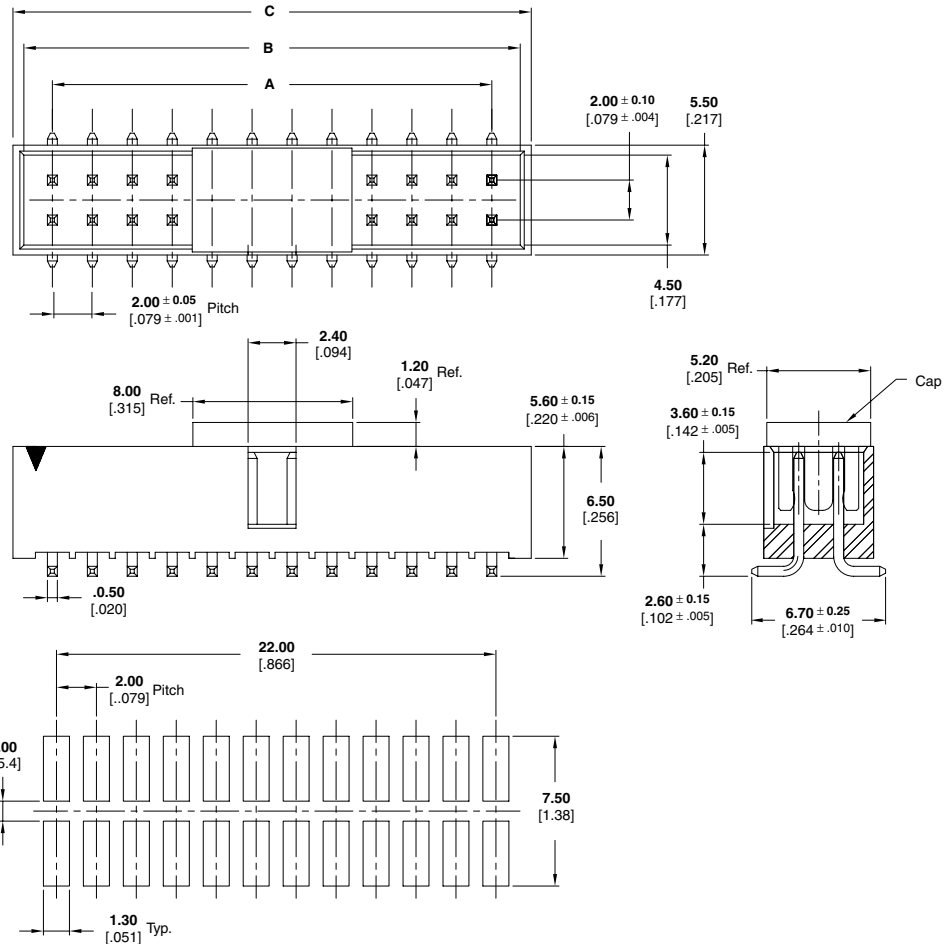

Recommended PCB Layout

| No. of Positions | Dimensions | | | Part Numbers |
|------------------|-------------|--------------|--------------|--------------|
| | A | B | C | |
| 8 | 6.0 [0.24] | 8.85 [0.35] | 9.95 [0.39] | 2041068-8 |
| 10 | 8.0 [0.31] | 10.85 [0.43] | 11.95 [0.47] | 1-2041068-0 |
| 12 | 10.0 [0.39] | 12.85 [0.51] | 13.95 [0.55] | 1-2041068-2 |
| 14 | 12.0 [0.47] | 14.85 [0.58] | 15.95 [0.63] | 1-2041068-4 |
| 16 | 14.0 [0.55] | 16.85 [0.66] | 17.95 [0.71] | 1-2041068-6 |
| 18 | 16.0 [0.63] | 18.85 [0.74] | 19.95 [0.79] | 1-2041068-8 |
| 20 | 18.0 [0.71] | 20.85 [0.82] | 21.95 [0.86] | 2-2041068-0 |
| 22 | 20.0 [0.79] | 22.85 [0.90] | 23.95 [0.94] | 2-2041068-2 |
| 24 | 22.0 [0.87] | 24.85 [0.98] | 25.95 [1.02] | 2-2041068-4 |
| 26 | 24.0 [0.94] | 26.85 [1.06] | 27.95 [1.10] | 2-2041068-6 |
| 28 | 26.0 [1.02] | 28.85 [1.14] | 29.95 [1.18] | 2-2041068-8 |
| 30 | 28.0 [1.10] | 30.85 [1.21] | 31.95 [1.26] | 3-2041068-0 |
| 32 | 30.0 [1.18] | 32.85 [1.29] | 33.95 [1.34] | 3-2041068-2 |
| 34 | 32.0 [1.26] | 34.85 [1.37] | 35.95 [1.42] | 3-2041068-4 |
| 36 | 34.0 [1.34] | 36.85 [1.45] | 37.95 [1.49] | 3-2041068-6 |
| 38 | 36.0 [1.42] | 38.85 [1.53] | 39.95 [1.57] | 3-2041068-8 |
| 40 | 38.0 [1.50] | 40.85 [1.61] | 41.95 [1.65] | 4-2041068-0 |
| 42 | 40.0 [1.57] | 42.85 [1.69] | 43.95 [1.73] | 4-2041068-2 |
| 44 | 42.0 [1.65] | 44.85 [1.77] | 45.95 [1.81] | 4-2041068-4 |
| 46 | 44.0 [1.73] | 46.85 [1.84] | 47.95 [1.89] | 4-2041068-6 |
| 48 | 46.0 [1.81] | 48.85 [1.92] | 49.95 [1.97] | 4-2041068-8 |
| 50 | 48.0 [1.89] | 50.85 [2.00] | 51.95 [2.05] | 5-2041068-0 |

Note: All part numbers are RoHS compliant.

2.0 Pitch Vertical

4

2mm Headers, Shrouded, Double Row, Surface Mount, Vertical Mount

(Continued)

0.5 [.02] Square Straight Posts

Material and Finish

Housing — Black high temperature thermoplastic, UL 94 V-O Rated

Posted Contacts — Phosphor Bronze, duplex plated as follows:

0.00076[0.000030] min. gold on contact area, 0.00381[.000150] min. tin on solder area, with entire contact underplated 0.00127[.000050] min. nickel

Product Specification

108-57328

Packaging Method — Tape and reel

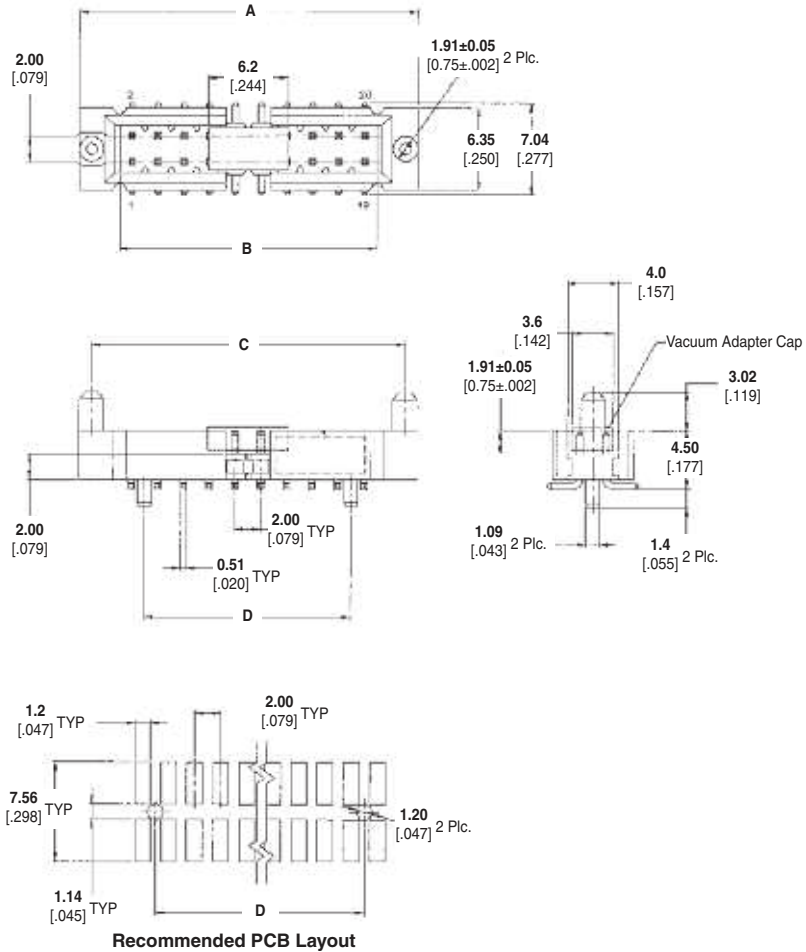

| No. of Positions | Dimensions | | | | Part Numbers |
|------------------|-------------|-------------|-------------|-------------|--------------|
| | A | B | C | D | |
| 20 | 26.2 [1.03] | 20.0 [0.79] | 24.3 [0.96] | 16.0 [.63] | 2-1734569-0 |
| 30 | 36.2 [1.43] | 30.0 [1.18] | 34.3 [1.35] | 26.0 [1.02] | 3-1734569-0 |

Note: All part numbers are RoHS compliant.

2mm Headers, Shrouded, Double Row, Thru-Hole, Vertical Mount

0.5 [.02] Square Straight Posts with Cable Shroud

Material and Finish

Housing — Black thermoplastic, UL 94 V-0 Rated

Posted Contacts — Brass, duplex plated as follows:
0.00254 [.000100] min. tin on contact area, with entire contact underplated
0.00127 [.000050] min. nickel

Related Product Data

Mateable Receptacles —
See Drawings 1470106 Contacts and 1470107 Housing

Product Specification
108-57217

Packaging Method — Loose piece, bag

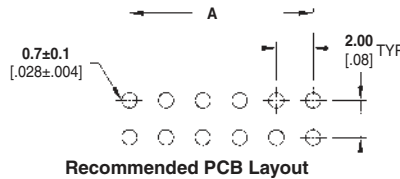
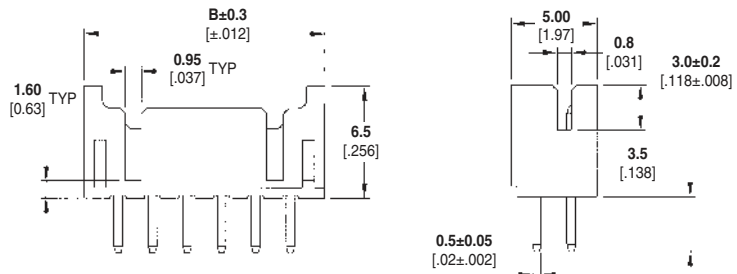
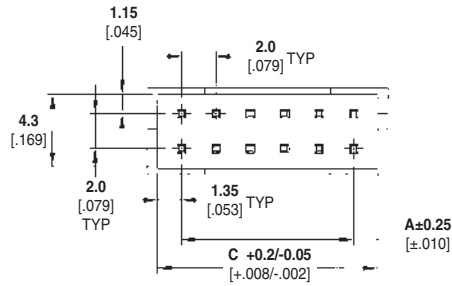

| No. of Position | Dimensions | | | Part Numbers |
|-----------------|-------------|-------------|--------------|--------------|
| | A | B | C | |
| 6 | 4.0 [0.16] | 8.0 [0.31] | 6.74 [0.26] | 1470109-6 |
| 8 | 6.0 [0.24] | 10.0 [0.39] | 8.74 [0.34] | 1470109-8 |
| 10 | 8.0 [0.31] | 12.0 [0.47] | 10.74 [0.42] | 1-1470109-0 |
| 12 | 10.0 [0.39] | 14.0 [0.55] | 12.74 [0.50] | 1-1470109-2 |
| 14 | 12.0 [0.47] | 16.0 [0.63] | 14.74 [0.58] | 1-1470109-4 |
| 16 | 14.0 [0.55] | 18.0 [0.71] | 16.74 [0.66] | 1-1470109-6 |
| 18 | 16.0 [0.63] | 20.0 [0.79] | 18.74 [0.74] | 1-1470109-8 |
| 20 | 18.0 [0.71] | 22.0 [0.87] | 20.74 [0.82] | 2-1470109-0 |
| 22 | 20.0 [0.79] | 24.0 [0.94] | 22.74 [0.89] | 2-1470109-2 |
| 24 | 22.0 [0.87] | 26.0 [1.02] | 24.74 [0.97] | 2-1470109-4 |
| 26 | 24.0 [0.94] | 28.0 [1.10] | 26.74 [1.05] | 2-1470109-6 |
| 28 | 26.0 [1.02] | 30.0 [1.18] | 28.74 [1.13] | 2-1470109-8 |
| 30 | 28.0 [1.10] | 32.0 [1.26] | 30.74 [1.21] | 3-1470109-0 |
| 32 | 30.0 [1.18] | 34.0 [1.34] | 32.74 [1.29] | 3-1470109-2 |

Note: All part numbers are RoHS compliant.

2mm Headers, Shrouded, Double Row, Thru-Hole, Right-Angle Mount

0.5 [.02] Square Right-Angle Posts with Cable Shroud

Material and Finish

Housing — Black thermoplastic, UL 94 V-0 Rated

Posted Contacts — Brass, duplex plated as follows:

0.00254 [.000100] min. tin on contact area, with entire contact underplated
0.00127 [.000050] min. nickel

Related Product Data

Mateable Receptacles — See Drawings 1470106 Contacts and 1470107 Housing

Product Specification
108-57217

Packaging Method — Loose piece, bag

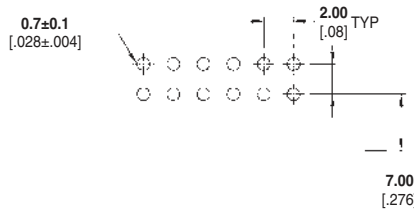
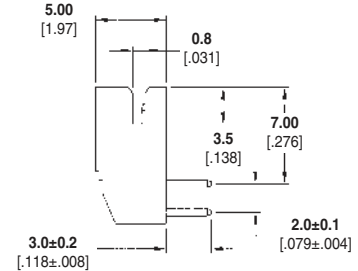
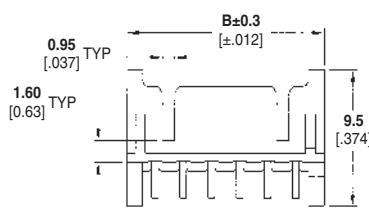
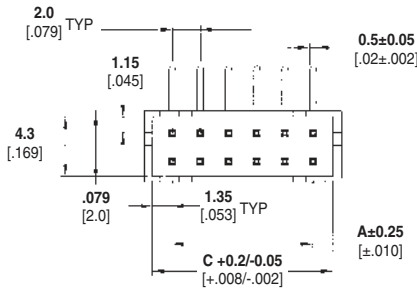

Recommended PCB Layout

| No. of Position | Dimensions | | | Part Numbers |
|-----------------|-------------|--------------|--------------|--------------|
| | A | B | C | |
| 6 | 4.0 [0.16] | 8.00 [0.31] | 6.74 [0.26] | 1470108-6 |
| 8 | 6.0 [0.24] | 10.00 [0.39] | 8.74 [0.34] | 1470108-8 |
| 10 | 8.0 [0.32] | 12.00 [0.47] | 10.74 [0.42] | 1-1470108-0 |
| 12 | 10.0 [0.39] | 14.00 [0.55] | 12.74 [0.50] | 1-1470108-2 |
| 14 | 12.0 [0.47] | 16.00 [0.63] | 14.74 [0.58] | 1-1470108-4 |
| 16 | 18.0 [0.71] | 18.00 [0.71] | 16.74 [0.66] | 1-1470108-6 |
| 18 | 14.0 [0.55] | 20.00 [0.79] | 18.74 [0.74] | 1-1470108-8 |
| 20 | 16.0 [0.63] | 22.00 [0.87] | 20.74 [0.82] | 2-1470108-0 |
| 22 | 22.0 [0.87] | 24.00 [0.94] | 22.74 [0.89] | 2-1470108-2 |
| 24 | 20.0 [0.79] | 26.00 [1.02] | 24.74 [0.97] | 2-1470108-4 |
| 26 | 24.0 [0.94] | 28.00 [1.10] | 26.74 [1.05] | 2-1470108-6 |
| 28 | 28.0 [1.10] | 30.00 [1.18] | 28.74 [1.13] | 2-1470108-8 |
| 30 | 26.0 [1.02] | 32.00 [1.26] | 30.74 [1.21] | 3-1470108-0 |
| 32 | 30.0 [1.18] | 34.00 [1.34] | 32.74 [1.29] | 3-1470108-2 |

Note: All part numbers are RoHS compliant.

2mm Centerline Receptacles, Double Row, Thru-Hole, Vertical Mount

Receptacle, Thru-Hole, Vertical

Material and Finish

Housing — Black thermoplastic, UL 94 V-0 Rated, 245°C Reflow

Contacts — Copper alloy, plated as follows:

A — 0.00020 [.000008] min. gold on contact area, 0.00203 [.000080] min. tin on solder area, with entire contact underplated 0.00127 [.000050] min. nickel

B — 0.00076 [.000030] min. gold on contact area, 0.00203 [.000080] min. tin on solder area, with entire contact underplated 0.00127 [.000050] min. nickel

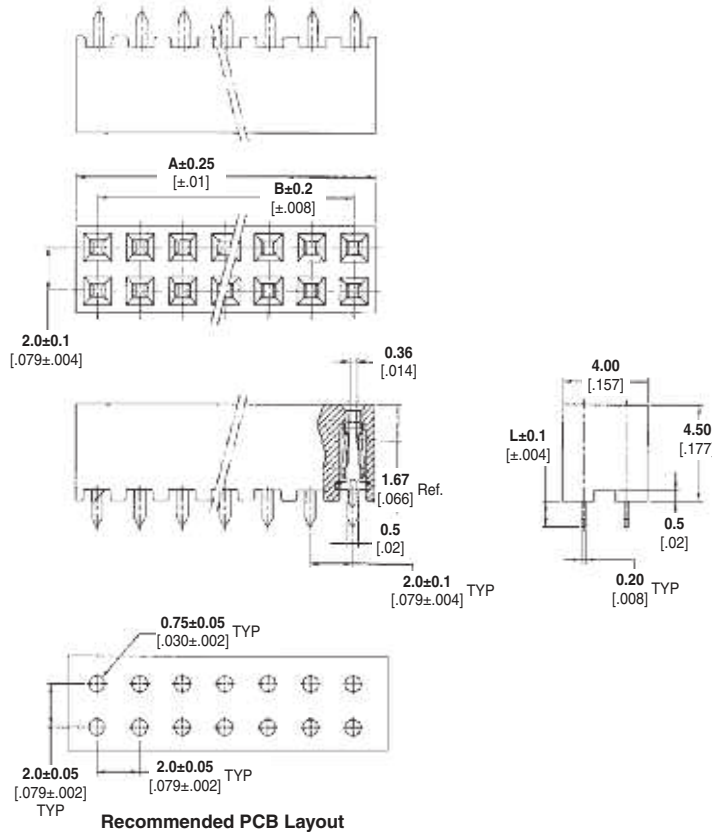

Related Product Data

Mateable Headers — pages 66-76, 78, 79

Product Specification 108-57197

Packaging Method — Tray

2.0 Mount Type w/PickUp

4

| No. of Positions | Dimensions | | Part Numbers | | | |
|------------------|--------------|--------------|---------------------------------------|---------------------------------------|---------------------------------------|---------------------------------------|
| | | | Plating A | | Plating B | |
| | | | Dim. L 1.2+/-0.1 (.047+/-0.004) | Dim. L 2.6+/-0.1 (.102+/-0.004) | Dim. L 1.2+/-0.1 (.047+/-0.004) | Dim. L 2.6+/-0.1 (.102+/-0.004) |
| 4 | 4.0 [.157] | 2.0 [.079] | 1470209-1 | 2-1470209-5 | 5-1470209-1 | 7-1470209-5 |
| 6 | 6.0 [.236] | 4.0 [.157] | 1470209-2 | 2-1470209-6 | 5-1470209-2 | 7-1470209-6 |
| 8 | 8.0 [.315] | 6.0 [.236] | 1470209-3 | 2-1470209-7 | 5-1470209-3 | 7-1470209-7 |
| 10 | 10.0 [.394] | 8.0 [.315] | 1470209-4 | 2-1470209-8 | 5-1470209-4 | 7-1470209-8 |
| 12 | 12.0 [.472] | 10.0 [.394] | 1470209-5 | 2-1470209-9 | 5-1470209-5 | 7-1470209-9 |
| 14 | 14.0 [.551] | 12.0 [.472] | 1470209-6 | 3-1470209-0 | 5-1470209-6 | 8-1470209-0 |
| 16 | 16.0 [.630] | 14.0 [.551] | 1470209-7 | 3-1470209-1 | 5-1470209-7 | 8-1470209-1 |
| 18 | 18.0 [.709] | 16.0 [.630] | 1470209-8 | 3-1470209-2 | 5-1470209-8 | 8-1470209-2 |
| 20 | 20.0 [.787] | 18.0 [.709] | 1470209-9 | 3-1470209-3 | 5-1470209-9 | 8-1470209-3 |
| 22 | 22.0 [.866] | 20.0 [.787] | 1-1470209-0 | 3-1470209-4 | 6-1470209-0 | 8-1470209-4 |
| 24 | 24.0 [.945] | 22.0 [.866] | 1-1470209-1 | 3-1470209-5 | 6-1470209-1 | 8-1470209-5 |
| 26 | 26.0 [1.024] | 24.0 [.945] | 1-1470209-2 | 3-1470209-6 | 6-1470209-2 | 8-1470209-6 |
| 28 | 28.0 [1.102] | 26.0 [1.024] | 1-1470209-3 | 3-1470209-7 | 6-1470209-3 | 8-1470209-7 |
| 30 | 30.0 [1.181] | 28.0 [1.102] | 1-1470209-4 | 3-1470209-8 | 6-1470209-4 | 8-1470209-8 |
| 32 | 32.0 [1.260] | 30.0 [1.181] | 1-1470209-5 | 3-1470209-9 | 6-1470209-5 | 8-1470209-9 |
| 34 | 34.0 [1.339] | 32.0 [1.260] | 1-1470209-6 | 4-1470209-0 | 6-1470209-6 | 9-1470209-0 |
| 36 | 36.0 [1.417] | 34.0 [1.339] | 1-1470209-7 | 4-1470209-1 | 6-1470209-7 | 9-1470209-1 |
| 38 | 38.0 [1.496] | 36.0 [1.417] | 1-1470209-8 | 4-1470209-2 | 6-1470209-8 | 9-1470209-2 |
| 40 | 40.0 [1.575] | 38.0 [1.496] | 1-1470209-9 | 4-1470209-3 | 6-1470209-9 | 9-1470209-3 |
| 42 | 42.0 [1.654] | 40.0 [1.575] | 2-1470209-0 | 4-1470209-4 | 7-1470209-0 | 9-1470209-4 |
| 44 | 44.0 [1.732] | 42.0 [1.654] | 2-1470209-1 | 4-1470209-5 | 7-1470209-1 | 9-1470209-5 |
| 46 | 46.0 [1.811] | 44.0 [1.732] | 2-1470209-2 | 4-1470209-6 | 7-1470209-2 | 9-1470209-6 |
| 48 | 48.0 [1.890] | 46.0 [1.811] | 2-1470209-3 | 4-1470209-7 | 7-1470209-3 | 9-1470209-7 |
| 50 | 50.0 [1.969] | 48.0 [1.890] | 2-1470209-4 | 4-1470209-8 | 7-1470209-4 | 9-1470209-8 |

Note: All part numbers are RoHS compliant.

2mm Centerline Receptacles, Double Row, Thru-Hole, Vertical Mount (Continued)

Receptacle, Thru-Hole, Vertical

Material and Finish

Housing — Black thermoplastic, UL 94 V-O Rated, 265°C Process Capable

Contacts — Copper alloy, plated as follows:

A — 0.00020 [.000008] min. gold on contact area, 0.00203 [.000080] min. tin on solder area, with entire contact underplated 0.00127 [.000050] min. nickel

B — 0.00076 [.000030] min. gold on contact area, 0.00203 [.000080] min. tin on solder area, with entire contact underplated 0.00127 [.000050] min. nickel

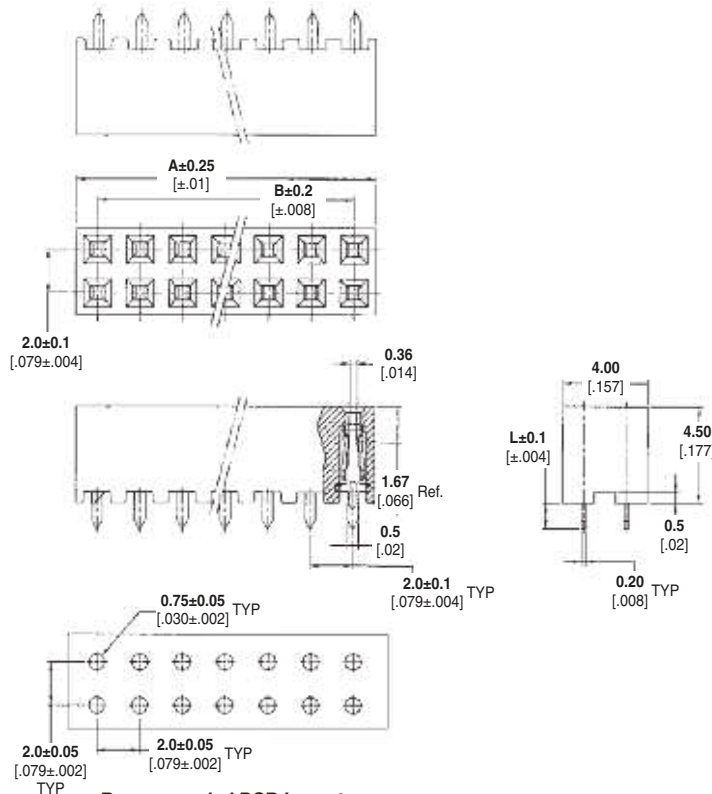

Related Product Data

Mateable Headers — pages 66-76, 78, 79

Product Specification 108-57197

Packaging Method — Tray

| No. of Positions | Dimensions | | Part Numbers | | | |
|------------------|--------------|--------------|---------------------------------------|---------------------------------------|---------------------------------------|---------------------------------------|
| | | | Plating A | | Plating B | |
| | | | Dim. L 1.2+/-0.1 (.047+/- .004) | Dim. L 2.6+/-0.1 (.102+/- .004) | Dim. L 1.2+/-0.1 (.047+/- .004) | Dim. L 2.6+/-0.1 (.102+/- .004) |
| 4 | 4.0 [.157] | 2.0 [.079] | 1734506-1 | 2-1734506-5 | 5-1734506-1 | 7-1734506-5 |
| 6 | 6.0 [.236] | 4.0 [.157] | 1734506-2 | 2-1734506-6 | 5-1734506-2 | 7-1734506-6 |
| 8 | 8.0 [.315] | 6.0 [.236] | 1734506-3 | 2-1734506-7 | 5-1734506-3 | 7-1734506-7 |
| 10 | 10.0 [.394] | 8.0 [.315] | 1734506-4 | 2-1734506-8 | 5-1734506-4 | 7-1734506-8 |
| 12 | 12.0 [.472] | 10.0 [.394] | 1734506-5 | 2-1734506-9 | 5-1734506-5 | 7-1734506-9 |
| 14 | 14.0 [.551] | 12.0 [.472] | 1734506-6 | 3-1734506-0 | 5-1734506-6 | 8-1734506-0 |
| 16 | 16.0 [.630] | 14.0 [.551] | 1734506-7 | 3-1734506-1 | 5-1734506-7 | 8-1734506-1 |
| 18 | 18.0 [.709] | 16.0 [.630] | 1734506-8 | 3-1734506-2 | 5-1734506-8 | 8-1734506-2 |
| 20 | 20.0 [.787] | 18.0 [.709] | 1734506-9 | 3-1734506-3 | 5-1734506-9 | 8-1734506-3 |
| 22 | 22.0 [.866] | 20.0 [.787] | 1-1734506-0 | 3-1734506-4 | 6-1734506-0 | 8-1734506-4 |
| 24 | 24.0 [.945] | 22.0 [.866] | 1-1734506-1 | 3-1734506-5 | 6-1734506-1 | 8-1734506-5 |
| 26 | 26.0 [1.024] | 24.0 [.945] | 1-1734506-2 | 3-1734506-6 | 6-1734506-2 | 8-1734506-6 |
| 28 | 28.0 [1.102] | 26.0 [1.024] | 1-1734506-3 | 3-1734506-7 | 6-1734506-3 | 8-1734506-7 |
| 30 | 30.0 [1.181] | 28.0 [1.102] | 1-1734506-4 | 3-1734506-8 | 6-1734506-4 | 8-1734506-8 |
| 32 | 32.0 [1.260] | 30.0 [1.181] | 1-1734506-5 | 3-1734506-9 | 6-1734506-5 | 8-1734506-9 |
| 34 | 34.0 [1.339] | 32.0 [1.260] | 1-1734506-6 | 4-1734506-0 | 6-1734506-6 | 9-1734506-0 |
| 36 | 36.0 [1.417] | 34.0 [1.339] | 1-1734506-7 | 4-1734506-1 | 6-1734506-7 | 9-1734506-1 |
| 38 | 38.0 [1.496] | 36.0 [1.417] | 1-1734506-8 | 4-1734506-2 | 6-1734506-8 | 9-1734506-2 |
| 40 | 40.0 [1.575] | 38.0 [1.496] | 1-1734506-9 | 4-1734506-3 | 6-1734506-9 | 9-1734506-3 |
| 42 | 42.0 [1.654] | 40.0 [1.575] | 2-1734506-0 | 4-1734506-4 | 7-1734506-0 | 9-1734506-4 |
| 44 | 44.0 [1.732] | 42.0 [1.654] | 2-1734506-1 | 4-1734506-5 | 7-1734506-1 | 9-1734506-5 |
| 46 | 46.0 [1.811] | 44.0 [1.732] | 2-1734506-2 | 4-1734506-6 | 7-1734506-2 | 9-1734506-6 |
| 48 | 48.0 [1.890] | 46.0 [1.811] | 2-1734506-3 | 4-1734506-7 | 7-1734506-3 | 9-1734506-7 |
| 50 | 50.0 [1.969] | 48.0 [1.890] | 2-1734506-4 | 4-1734506-8 | 7-1734506-4 | 9-1734506-8 |
| 40* | 40.0 [1.575] | 38.0 [1.496] | — | 4-1734506-9 | — | 9-1734506-9 |

*Keying position 6.

Note: All part numbers are RoHS compliant.

2mm Receptacle, Double Row, Surface Mount, Right-Angle Mount

Receptacle, Surface Mount, Right-Angle

Material and Finish

Housing — Black Thermoplastic, UL 94V-0 Rated

Contact — Phosphor Bronze

Contact Finish — 0.00020 [.000008]

Min. Gold Plated on Contact Area, 0.00229 [.000090] Min. Tin Plated on Solder Tail, 0.00127 [.000050] Min. Nickel Underplated Over All

Related Product Data

Mateable Headers — pages 66-73

Product Specification
108-57197

Packaging Method — Tape and reel

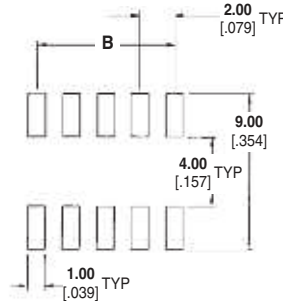
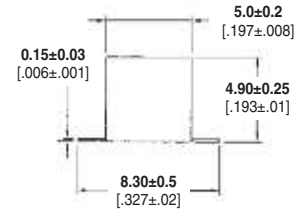
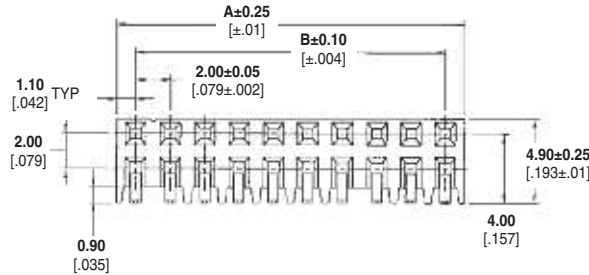
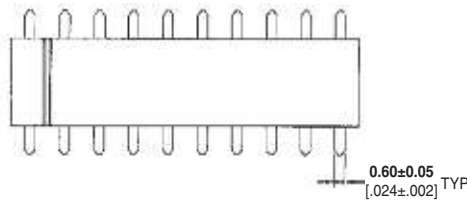

Recommended PCB Layout

| Position | Dimensions | | Part Numbers |
|----------|---------------|--------------|--------------|
| | A | B | |
| 6 | 6.20 [.244] | 4.0 [.157] | 1734606-6 |
| 8 | 8.20 [.323] | 6.0 [.236] | 1734606-8 |
| 10 | 10.20 [.402] | 8.0 [.315] | 1-1734606-0 |
| 12 | 12.20 [.480] | 10.0 [.394] | 1-1734606-2 |
| 14 | 14.20 [.559] | 12.0 [.472] | 1-1734606-4 |
| 16 | 16.20 [.638] | 14.0 [.551] | 1-1734606-6 |
| 18 | 18.20 [.717] | 16.0 [.630] | 1-1734606-8 |
| 20 | 20.20 [.795] | 18.0 [.709] | 2-1734606-0 |
| 22 | 22.20 [.874] | 20.0 [.787] | 2-1734606-2 |
| 24 | 24.20 [.953] | 22.0 [.866] | 2-1734606-4 |
| 26 | 26.20 [1.031] | 24.0 [.945] | 2-1734606-6 |
| 28 | 28.20 [1.110] | 26.0 [1.024] | 2-1734606-8 |
| 30 | 30.20 [1.189] | 28.0 [1.102] | 3-1734606-0 |
| 32 | 32.20 [1.268] | 30.0 [1.181] | 3-1734606-2 |
| 34 | 34.20 [1.346] | 32.0 [1.260] | 3-1734606-4 |
| 36 | 36.20 [1.425] | 34.0 [1.339] | 3-1734606-6 |
| 38 | 38.20 [1.504] | 36.0 [1.417] | 3-1734606-8 |
| 40 | 40.20 [1.583] | 38.0 [1.496] | 4-1734606-0 |
| 42 | 42.20 [1.661] | 40.0 [1.575] | 4-1734606-2 |
| 44 | 44.20 [1.740] | 42.0 [1.654] | 4-1734606-4 |
| 46 | 46.20 [1.819] | 44.0 [1.732] | 4-1734606-6 |
| 48 | 48.20 [1.898] | 46.0 [1.811] | 4-1734606-8 |
| 50 | 50.20 [1.976] | 48.0 [1.890] | 5-1734606-0 |

Note: All part numbers are RoHS compliant.

2mm Receptacle, Double Row, Thru-Hole, Right-Angle Mount

Receptacle, Thru-Hole, Right-Angle

Material and Finish

Housing — Black Thermoplastic, UL 94V-0 Rated

Contact — Phosphor Bronze

Contact Finish — 0.00020 [.000008]

Min. Gold Plated on Contact Area, 0.00254 [.000100] Min. Tin Plated on Solder Tail, 0.00127 [.000050] Min. Nickel Underplated Over All

Related Product Data

Mateable Headers — pages 66-73

Product Specification

108-57197

Packaging Method — Tube

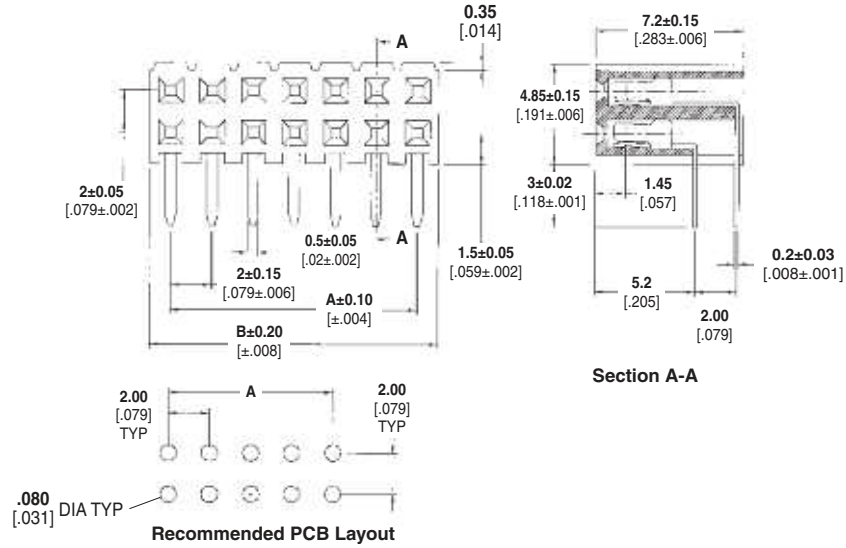

| Position | Dimensions | | Part Numbers |
|----------|--------------|---------------|--------------|
| | A | B | |
| 8 | 6.0 [.236] | 8.50 [.335] | 1734531-8 |
| 10 | 8.0 [.315] | 10.50 [.413] | 1-1734531-0 |
| 12 | 10.0 [.394] | 12.50 [.492] | 1-1734531-2 |
| 14 | 12.0 [.472] | 14.50 [.571] | 1-1734531-4 |
| 16 | 14.0 [.551] | 16.50 [.650] | 1-1734531-6 |
| 18 | 16.0 [.630] | 18.50 [.728] | 1-1734531-8 |
| 20 | 18.0 [.709] | 20.50 [.807] | 2-1734531-0 |
| 22 | 20.0 [.787] | 22.50 [.886] | 2-1734531-2 |
| 24 | 22.0 [.866] | 24.50 [.965] | 2-1734531-4 |
| 26 | 24.0 [.945] | 26.50 [1.043] | 2-1734531-6 |
| 28 | 26.0 [1.024] | 28.50 [1.122] | 2-1734531-8 |
| 30 | 28.0 [1.102] | 30.50 [1.201] | 3-1734531-0 |
| 32 | 30.0 [1.181] | 32.50 [1.280] | 3-1734531-2 |
| 34 | 32.0 [1.260] | 34.50 [1.358] | 3-1734531-4 |
| 36 | 34.0 [1.339] | 36.50 [1.437] | 3-1734531-6 |
| 38 | 36.0 [1.417] | 38.50 [1.516] | 3-1734531-8 |
| 40 | 38.0 [1.496] | 40.50 [1.594] | 4-1734531-0 |
| 42 | 40.0 [1.575] | 42.50 [1.673] | 4-1734531-2 |
| 44 | 42.0 [1.654] | 44.50 [1.752] | 4-1734531-4 |
| 46 | 44.0 [1.732] | 46.50 [1.831] | 4-1734531-6 |
| 48 | 46.0 [1.811] | 48.50 [1.909] | 4-1734531-8 |
| 50 | 48.0 [1.890] | 50.50 [1.988] | 5-1734531-0 |
| 52 | 50.0 [1.969] | 52.50 [2.067] | 5-1734531-2 |
| 54 | 52.0 [2.047] | 54.50 [2.146] | 5-1734531-4 |
| 56 | 54.0 [2.123] | 56.50 [2.224] | 5-1734531-6 |
| 58 | 56.0 [2.205] | 58.50 [2.303] | 5-1734531-8 |
| 60 | 58.0 [2.283] | 60.50 [2.381] | 6-1734531-0 |
| 62 | 60.0 [2.362] | 62.50 [2.461] | 6-1734531-2 |
| 64 | 62.0 [2.441] | 64.50 [2.539] | 6-1734531-4 |
| 66 | 64.0 [2.520] | 66.50 [2.618] | 6-1734531-6 |
| 68 | 66.0 [2.598] | 68.50 [2.697] | 6-1734531-8 |
| 70 | 68.0 [2.677] | 70.50 [2.776] | 7-1734531-0 |
| 72 | 70.0 [2.756] | 72.50 [2.854] | 7-1734531-2 |
| 74 | 72.0 [2.834] | 74.50 [2.933] | 7-1734531-4 |
| 76 | 74.0 [2.913] | 76.50 [3.012] | 7-1734531-6 |
| 78 | 76.0 [2.992] | 78.50 [3.091] | 7-1734531-8 |
| 80 | 78.0 [3.071] | 80.50 [3.169] | 8-1734531-0 |

Note: All part numbers are RoHS compliant.

2mm Receptacle, Double Row, Surface Mount, Vertical Mount

Receptacle, Top Entry, Surface Mount

Material and Finish

Housing—Black Thermoplastic, UL 94V-0 Rated
Contact—Copper Alloy, plated 0.00076 [.000030] Min. Gold Plated on Contact Area, 0.00254 [.000100] Tin Plated on Solder Tail, Underplated 0.00127 [.000050] Nickel
Cap—Thermoplastic

Related Product Data

Mateable Headers—pages 66-75, 78, 79

Product Specification
108-57227

Packaging Method—Tape and reel

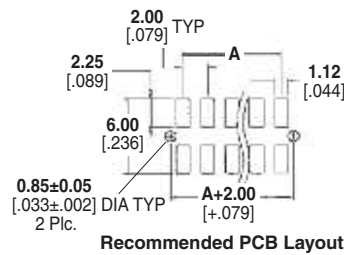
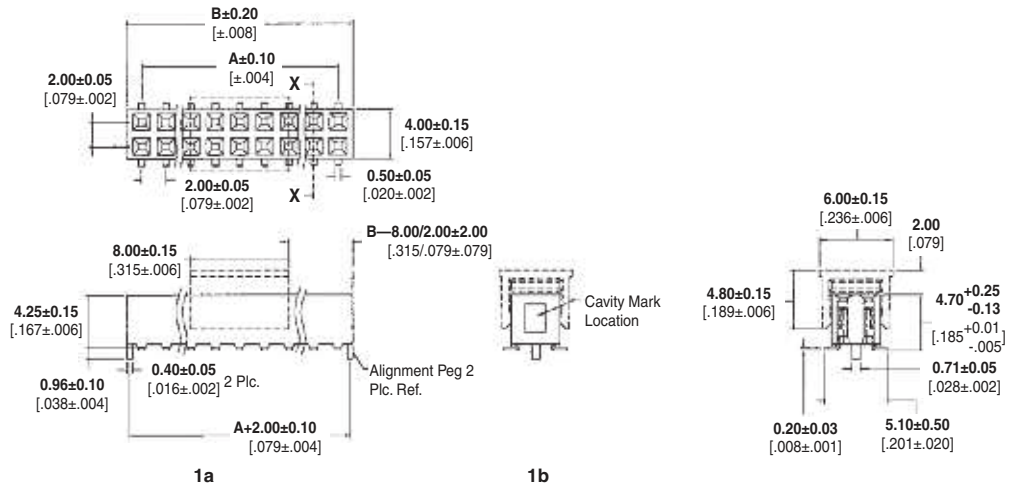

Recommended PCB Layout

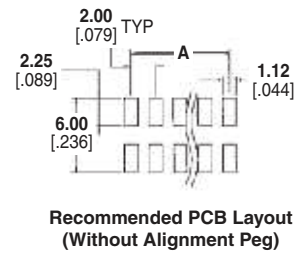

Recommended PCB Layout (Without Alignment Peg)

| Position | Dimensions | | 245C Reflow Part Numbers | | 265C Reflow Part Numbers | |
|----------|--------------|---------------|--------------------------|-----------------------|--------------------------|-----------------------|
| | A | B | with Alignment Peg* | without Alignment Peg | with Alignment Peg* | without Alignment Peg |
| 8 | 6.0 [.236] | 8.40 [.331] | 1734516-8 | 5-1734516-8 | 2041069-8 | 5-2041069-8 |
| 10 | 8.0 [.315] | 10.40 [.409] | 1-1734516-0 | 6-1734516-0 | 1-2041069-0 | 6-2041069-0 |
| 12 | 10.0 [.394] | 12.40 [.488] | 1-1734516-2 | 6-1734516-2 | 1-2041069-2 | 6-2041069-2 |
| 14 | 12.0 [.472] | 14.40 [.567] | 1-1734516-4 | 6-1734516-4 | 1-2041069-4 | 6-2041069-4 |
| 16 | 14.0 [.551] | 16.40 [.646] | 1-1734516-6 | 6-1734516-6 | 1-2041069-6 | 6-2041069-6 |
| 18 | 16.0 [.630] | 18.40 [.724] | 1-1734516-8 | 6-1734516-8 | 1-2041069-8 | 6-2041069-8 |
| 20 | 18.0 [.709] | 20.40 [.803] | 2-1734516-0 | 7-1734516-0 | 2-2041069-0 | 7-2041069-0 |
| 22 | 20.0 [.787] | 22.40 [.881] | 2-1734516-2 | 7-1734516-2 | 2-2041069-2 | 7-2041069-2 |
| 24 | 22.0 [.866] | 24.40 [.961] | 2-1734516-4 | 7-1734516-4 | 2-2041069-4 | 7-2041069-4 |
| 26 | 24.0 [.945] | 26.40 [1.039] | 2-1734516-6 | 7-1734516-6 | 2-2041069-6 | 7-2041069-6 |
| 28 | 26.0 [1.024] | 28.40 [1.118] | 2-1734516-8 | 7-1734516-8 | 2-2041069-8 | 7-2041069-8 |
| 30 | 28.0 [1.102] | 30.40 [1.197] | 3-1734516-0 | 8-1734516-0 | 3-2041069-0 | 8-2041069-0 |
| 32 | 30.0 [1.181] | 32.40 [1.276] | 3-1734516-2 | 8-1734516-2 | 3-2041069-2 | 8-2041069-2 |
| 34 | 32.0 [1.260] | 34.40 [1.354] | 3-1734516-4 | 8-1734516-4 | 3-2041069-4 | 8-2041069-4 |
| 36 | 34.0 [1.339] | 36.40 [1.433] | 3-1734516-6 | 8-1734516-6 | 3-2041069-6 | 8-2041069-6 |
| 38 | 36.0 [1.417] | 38.40 [1.512] | 3-1734516-8 | 8-1734516-8 | 3-2041069-8 | 8-2041069-7 |
| 40 | 38.0 [1.496] | 40.40 [1.591] | 4-1734516-0 | 9-1734516-0 | 4-2041069-0 | 9-2041069-0 |

*See views 1a and 1b

Note: All part numbers are RoHS compliant.

AMPMODU .025 [0.64] Square Interconnection System

AMPMODU Headers and Receptacles, .100 [2.54] Centerline

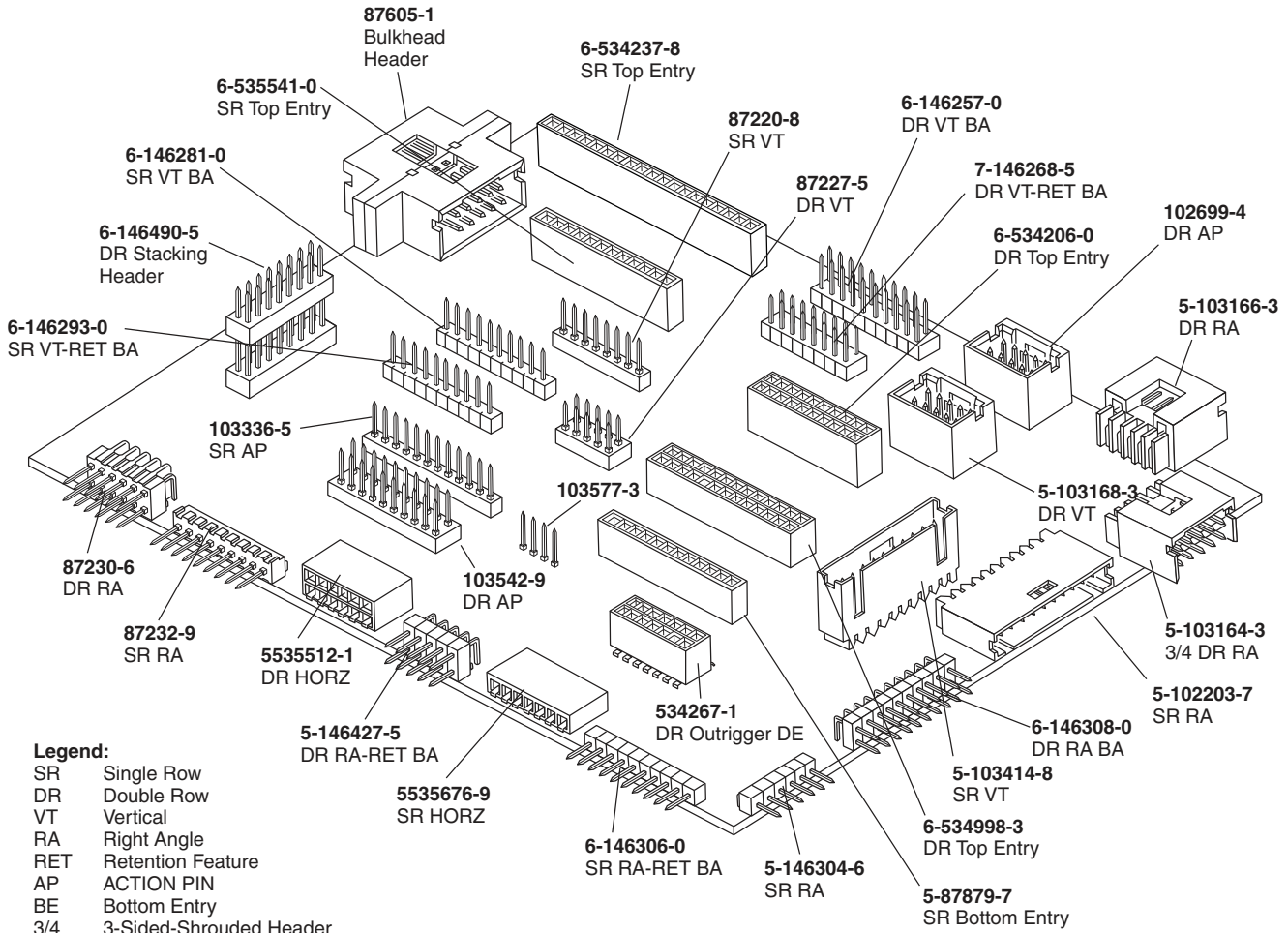

Legend:

- SR Single Row
- DR Double Row
- VT Vertical
- RA Right Angle
- RET Retention Feature
- AP ACTION PIN
- BE Bottom Entry
- 3/4 3-Sided-Shrouded Header
- BA Breakaway
- TR Triple Row
- SMT Surface Mount
- HORZ Horizontal
- DE Dual Entry

For drawings, technical data or samples, contact your TE sales engineer or call the TE Product Information Center: 1-800-522-6752

Note: All part numbers are RoHS compliant.

AMPMODU .025 [0.64] Square Interconnection System (Continued)

AMPMODU Headers and Receptacles, .100 [2.54] Centerline

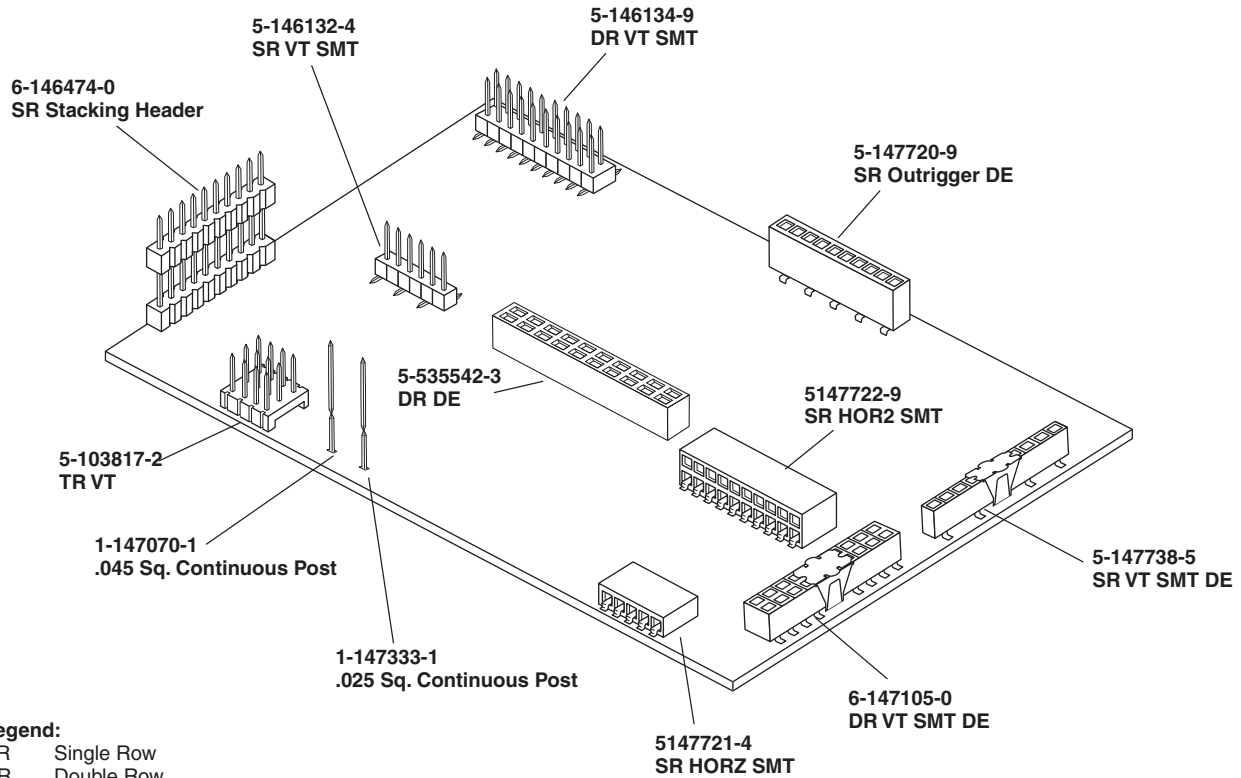

Legend:

- SR Single Row
- DR Double Row
- VT Vertical
- RA Right Angle
- RET Retention Feature
- AP ACTION PIN
- BE Bottom Entry
- 3/4 3-Sided-Shrouded Header
- BA Breakaway
- TR Triple Row
- SMT Surface Mount
- HORZ Horizontal
- DE Dual Entry

For drawings, technical data or samples, contact your TE sales engineer or call the TE Product Information Center: 1-800-522-6752

Note: All part numbers are RoHS compliant.

AMPMODU .025 [0.64] Square Interconnection System

The AMPMODU interconnection system provides interconnections with a unique modular concept, utilizing precision formed receptacle contacts and mating posts.

Mating of the post and receptacle contacts of this system is very tolerant. This is made possible by a post with a burr-free lead-in and a receptacle contact featuring double cantilever beams and anti-overstress stops.

AMPMODU receptacle contacts and posts categorically fall into three general classifications of products, which include: board mounted posts and receptacle assemblies, post headers and wire-applied contact housings for crimp snap-in pin and receptacle contacts.

Board mounted receptacle assemblies are available in various geometries, offering packaging interconnections that include perpendicular, parallel and stacking capabilities.

Crimp snap-in pins for 26-22 AWG [0.12-0.4 mm²] wire and crimp snap-in receptacles for 32-20 AWG [0.03-0.6 mm²] wire provide excellent discrete wire terminations. Housings for these contacts provide ease of handling terminations in high density applications.

Machine applied terminations, through matched application equipment, are geared for virtually any production volume requirement, for the lowest possible applied cost.

AMPMODU mating posts are supplied typically as headers. They are available in various populations to meet the interconnection and packaging requirements of most systems. However, in instances where packaging configurations do not lend themselves to the economies of headers, TE can provide application equipment for the discrete location of individual posts.

Looking at the electronic industry's standard "levels of packaging," the AMPMODU .025 [0.64] square interconnection system is primarily used in levels three and four.

In level three it is used as a connection between two or more printed circuits. A mother/daughter board connection is typical. In level four it is used as a

connection between two subassemblies, such as a power supply and an associated subassembly.

It is also important to note this product can serve as an interconnection in more than one level, depending on the application.

The .025 [0.64] square interconnection system offers the most complete line of post/receptacle packaging products available today. This system, rated at 3 amperes per contact, has been used by almost every industry and marketplace over the last decade and is one of the oldest, most versatile and reliable interconnection systems employing .025 [0.64] square packaging technology.

Terms Explained

Receptacle Contacts

The AMPMODU receptacle cross-section is primarily rectangular, with rounded corners. Two integral cantilever beams contact the mating square or round male posts. Deflection of these spring members is limited by anti-overstress stops, and excessive permanent deformation is prevented. This feature allows a wide range for tolerance of misalignment of mating contacts.

The configuration of the receptacle completely encloses the spring members preventing damage during handling and assembly and makes the system compatible with automatic application techniques.

Note: Application of a contact lubricant is part of the manufacturing process of all AMPMODU tin-plated crimp products. However, it is not part of the manufacturing process of products that customers will solder, then clean. For these products, TE recommends that customers use contact lubricant. See the TE web page for further information.

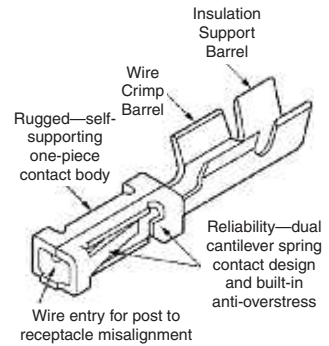

Offers standard, intermediate and high pressure contact forces

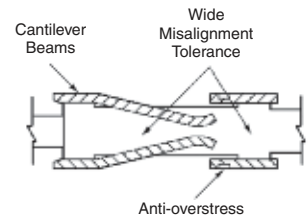

Receptacle-Closed Entry Housing Design

The closed entry housing style better eliminates the chance of a mating post stubbing on the edges of the receptacle contact.

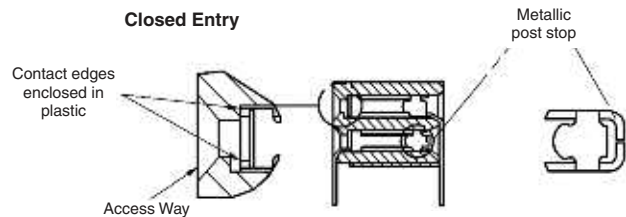
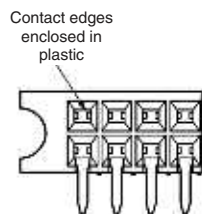

Wire-to-Board, .100 [2.54] Centerline Products

Wire Sizes

| Wire Size | | Product Family |
|-----------|--------------------|--|
| AWG | [mm ²] | |
| 20 | 0.5-0.6 | Locking Clip, Mod. IV, IV.v, V, MT, Short Point |
| 22-30 | 0.3-0.05 | Locking Clip, Mod. IV, IV.v, V, MTE, MT, Short Point |
| 32 | 0.03 | Mod. IV, IV.v, V, Short Point |

Contact Platings

| Platings | Product Family |
|----------------------------------|--|
| .000015 [0.00038] Gold | Mod. IV, IV.v, V, MTE, MT, Short Point |
| .000030 [0.00076] Gold | Locking Clip, Mod. IV, IV.v, V, MTE, MT, Short Point |
| .000050 [0.00127] Gold | Locking Clip, Mod. IV, IV.v, V, MT |
| Tin | Locking Clip, Mod. IV, IV.v, V, MTE, MT, Short Point |

Mating Post Lengths

| Post Lengths | Product Family |
|------------------------------|---|
| .210-.283 [5.33-7.19] | Mod. IV (.600 [15.24] Profile Height) |
| .205-.283 [5.21-7.19] | Mod. IV.v (.600 [15.24] Profile Height) |
| .185-.283 [4.70-7.19] | Mod. V (.600 [15.24] Profile Height) |
| .256-.323 [6.50-8.20] | Mod. IV (.645 [16.38] Profile Height) |
| .251-.323 [6.38-8.20] | Mod. IV.v (.645 [16.38] Profile Height) |
| .231-.323 [5.87-8.20] | Mod. V (.645 [16.38] Profile Height) |
| .222-.273 [5.64-6.93] | MT Assembly with Standard Pressure Contacts |
| .200-.273 [5.08-6.93] | MT Assembly with High Pressure Contacts |
| .200-.250 [5.08-6.35] | MTE Assembly |
| .169-.259 [4.29-6.58] | Short Point Connector Assembly |
| .273-.350 [6.93-8.89] | Locking Clip (Connector Assembly) |
| .200-.277 [5.08-7.04] | Locking Clip (Single Contact) |

Application Tooling

| Application Tooling Description | Product Family | | | | | |
|---|------------------|----|--------------|-----|-------------|---------|
| | Mod. IV, IV.v, V | MT | Locking Clip | MTE | Short Point | Level V |
| Manual Hand Tools (Wire Crimp) | • | | • | • | • | |
| Manual Hand Tools (IDC) | | • | | • | | • |
| AMP-O-MATIC Stripper/Crimper Machines with Applicator | • | | • | | • | |
| CHAMPOMATOR Model 2.5 Machine | | • | | | | • |
| CHAMPOMATOR Model 3A Machine | | • | | | | |
| AMP-O-LECTRIC Machines with Applicator | • | | • | | • | |
| Pneumatic Hand Tools | • | • | • | • | • | • |
| IDC Electric Power Unit | | | | • | | |
| Tube-Fed Ribbon Cable Machine | | | | • | | |
| AMPOMATOR CLS Machines | • | | • | | • | |
| Discrete Wire Machine | | • | | | | • |
| Manual Arbor Tool | | • | | | | • |
| Pneumatic Arbor Tool | | • | | | | • |

Board-to-Board Solutions Guide, .100 [2.54] Centerline Products

| Problem or Concern | TE's Potential Solution | Single-Row Vertical Headers and Receptacles (Page Ref.) | Single-Row Right-Angle Headers, Horizontal Receptacles (Page Ref.) | Double-Row Vertical Headers and Receptacles (Page Ref.) | Double-Row Right-Angle Headers, Horizontal Receptacles (Page Ref.) | |
|---|--|---|--|---|--|--|
| Headers Float Off Board Soldering Operation | HEADERS Retention Feature: Unshrouded Shrouded | 102 — | 103 — | 198 104, 199 | 199 105, 200 | |
| Header Contacts Damaged During Manufacturing Operation or In-Field Use | Shrouded HEADERS : Standard Profile | 115 | 116 | 117-121 | 122-128 | |
| Board/Backplane Requires High Temperature Surface-Mount Compatibility | Press-Fit ACTION PIN POST | | | | | |
| | HEADERS : Unshrouded Shrouded | 146 — | — — | 147 148, 149, 199 | — — | |
| | Machine Applied Posts | 163, 164 | | | | |
| Application Requires Board Guidance, Polarization and/or Blind-Mate Capability | Surface-Mount Compatible Thru-Hole: HEADERS : Unshrouded Shrouded (Low Profile) RECEPTACLES | 102* — — | 103* — — | 104* 130*, 137* 196* | 105* 138* 195* | |
| | Surface-Mount: HEADERS RECEPTACLES | 109* 187, 188 | — 172 | 110 189-192 | — 173 | |
| | Two-Piece Family: w/Guide Posts: HEADERS RECEPTACLES | — — | — — | 198, 199 196* | 200 195* | |
| Reduction in Parallel Board-to-Board Stack Height Necessary (Refer to Parallel Stack Guide on Page 62.) | Mod IV Low Profile RECEPTACLES : TOP ENTRY : Thru-Hole Surface-Mount BOTTOM ENTRY : Thru-Hole Surface-Mount DUAL ENTRY : Thru-Hole Surface Mount | 178 — — 177 — 181 187, 188 | — — — — — — | 179, 180* — — — 182-184 189-192 | — — — — — — | |
| | Soldering Problems with Thru-Hole Bottom Entry Receptacles (Must Mask Post Holes in Board During Soldering Operation) | RECEPTACLES : Bottom Entry Outrigger (Separate Holes for Receptacle Leads and Mating Leads) | 181 | — | 182 | — |
| | Application Requires Connectors to be End-to-End Stackable on .100 [2.54] Grid | End-to-End Stackable: HEADERS (Unshrouded): Thru-Hole Thru-Hole* Surface-Mount RECEPTACLES : Thru-Hole Surface Mount | 93, 102 102* 109* 175, 177, 178, 181 188 | 94, 95, 103* 103* — 169* 172 | 96, 97, 104* 104* 110* 176, 179, 180*, 182*, 183, 184 191, 192 | 98, 99, 105 108* — 170 173 |

*High temperature compatible version, refer to page ref. listed.

Wire-to-Board Solutions Guide, .100 [2.54] Centerline Products

| Customer Requirement | TE's Potential Solution | Catalog Page(s) |
|---|---|--------------------|
| Application Requires Guidance, Polarization | Mod IV Polarized Housing | 220 |
| | MTE Latched Receptacle and Header | 230, 231, 244-250 |
| | MT with Polarizing Covers | 256-258 |
| Wire-to-Wire Application | Short Point Polarized Housing | 224 |
| | Mod IV Receptacle Contacts and Pins | 211-213 |
| Wire-to-Wire Application (Latched) | MTE Latched Receptacle and Shrouded Pin Assembly | 230, 231, 236, 237 |
| Wire-to-Wire Application (Through Panel) | MTE Panel Mount | 242 |
| High Vibration and Shock Applications | Locking Clip Contacts and Housings | 207-209 |
| Printed Circuit Board Polarization | MTE Header with PC Board Orientation Peg | 248, 249 |
| Board Requires Surface Mount Capability | MTE Surface Mount Headers | 251, 252 |
| | MTE High Temperature Compatible Headers | 249, 250 |
| Need to mate to AMP-LATCH Eject Headers | Mod IV Ejection Housing | 220 |
| Need to Minimize Strain to Cable | MT with Eject Covers | 256-259 |
| | Mod IV Housing with Strain Relief | 218, 219 |
| Application Requires Self-Retaining Contacts | Locking Clip Contacts | 207, 298 |
| Header Secured to Board During/Prior to Soldering | MTE Headers with Post Retention or Holddowns | 244-250 |
| Mate to Unshrouded Header with Retention Requirements | Mod IV plain Housing with Mod V Contacts | 213, 214, 216 |
| | MTE with High Pressure Contacts | 234, 235 |
| Multiple Cables to be Common to One Header | MTE Coupling Shroud, Double- or Single-Row | 240, 241 |
| Right-Angle Cable Dress | MT with Hermaphroditic Covers | 229, 256, 257, 259 |
| Application Requires Crimp Contacts and MTE Housings | Short Point Contacts | 222 |
| Housings and End-to-End and Side-to-Side Stackable | Short Point Double-Row Housing, MTE Plain Housing | 223, 228, 229 |
| Connector Must Mate to Post Lengths of .169 [4.29] Min. | Short Point Contacts | 222 |

Mating Post Selection Guide

The following selection guide is provided to help in choosing a mating product after a receptacle, header or post has been selected.

In some instances references are given on the catalog page to specific mating connectors. In other instances the reader is referred here to the selection guide for mating product recommendations.

If your application requirement is not answered here, consult TE for further recommendations.

Posts Without Shoulders

For drawn wire products (ie, AMPMODU Breakaway and Low Profile Headers) and for products having the shoulder of the post below the housing or pc board surface (ie, AMPMODU MTE and Single Row Shrouded Headers) the effective mating length starts at the housing or pc board surface.

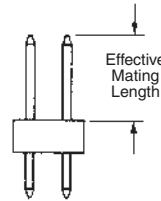

Posts With Shoulders

For product having the shoulder of the post extending above the housing or pc board surface (ie, Standard AMPMODU Shrouded and Unshrouded Headers) the effective mating length starts at the top of the shoulder.

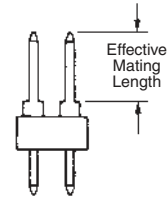

| Receptacle Type | Recommended Effective Mating Posts Lengths | |
|--|---|-------------|
| | Minimum | Maximum |
| AMPMODU Mod II Horizontal Board Mount Receptacle, Single and Double Row, Short Point-of-Contact—pages 169, 170, 172, 173 | .230 [5.84] | .280 [7.11] |
| AMPMODU Mod II Vertical Board Mount Receptacle, Single Row, Standard Profile, Top Entry—page 175 | .183 [4.65] | .330 [8.38] |
| AMPMODU Mod II Vertical Board Mount Receptacle, Standard Profile, Double Row, Top Entry, 100 x .100 mt.—page 176 | .183 [4.65] | .330 [8.38] |
| AMPMODU Mod IV Vertical Board Mount Receptacle, Low Profile, Single Row, Top Entry, Single Tine—page 178 | .183 [4.65] | .255 [6.48] |
| AMPMODU Mod IV Vertical Board Mount Receptacle, Low Profile, Single Row, Bottom Entry—page 177 | .280 [7.11] | * |
| AMPMODU Mod IV Vertical Board Mount Receptacle, Low Profile, Double Row, Top Entry—pages 179, 180 | .183 [4.65] | .255 [6.48] |
| AMPMODU Surface-Mount Receptacle, Vertical Board Mount, Single Row, Dual Entry—page 187, 188 | Top Entry .183 [4.65] Bottom Entry .204 [5.18] | * * |
| AMPMODU Mod IV Vertical Board Mount Receptacle, Low Profile, Double Row, Dual Entry—page 182 | Top Entry .183 [4.65] Bottom Entry .204 [5.18] | * * |
| AMPMODU Surface-Mount Receptacle, Vertical Board Mount, Double Row, Dual Entry—page 189-192 | Top Entry .183 [4.65] Bottom Entry .204 [5.18] | * * |
| AMPMODU .600 [15.24] Mod IV Housing with Standard Pressure Contacts—pages 211-220 | .210 [5.33] | .283 [7.19] |
| AMPMODU .600 [15.24] Mod IV Housing with Intermediate Pressure Contacts—pages 211-220 | .205 [5.21] | .283 [7.19] |
| AMPMODU .600 [15.24] Mod IV Housing with High Pressure Contacts—pages 211-220 | .185 [4.70] | .283 [7.19] |
| AMPMODU Mod IV Vertical Board Mount Receptacle, Low Profile, Single Row, Dual Entry—page 181 | Top Entry .183 [4.65] Bottom Entry .204 [5.18] | * * |

| Receptacle Type | Recommended Effective Mating Posts Lengths | |
|--|--|-------------------------|
| | Minimum | Maximum |
| Short Point Housing with Contacts—pages 222-224 | .169 [4.29] | .259 [6.58] |
| AMPMODU MTE Unloaded Housing with Short Point Contacts—pages 222, 229, 231, 233 | .169 [4.29] | .259 [6.58] |
| AMPMODU MTE IDC Assemblies | .200 [5.08] | .250 [6.35] |
| AMPMODU MT IDC Assembly with Standard Pressure Contacts—page 256 | .222 [5.64] | .273 [6.93] |
| AMPMODU MT IDC Assembly with High Pressure Contacts—page 257 | .200 [5.08] | .273 [6.93] |
| Locking Clip Housing with Contacts—pages 207-209 | .273 [6.93] | .350 [8.89] |
| Locking Clip Contact without Housing—page 207 | .200 [5.08] | .277 [7.04] |
| Flexible Flat Conductor Cable Receptacle with Round Wire Crimp High Pressure Contact—Catalog 82007 | Single Row | .267 [6.78] .323 [8.20] |
| | Double Row | .282 [7.16] .323 [8.20] |
| Flexible Flat Conductor Cable Receptacle with Multiple Wire Crimp High Pressure Contact—Catalog 82007 | Single Row | .210 [5.33] .323 [8.20] |
| | Double Row | .225 [5.72] .323 [8.20] |
| Flexible Flat Conductor Cable Receptacle with Round Wire Crimp Standard Pressure Contact—Catalog 82007 | Single Row | .267 [6.78] .323 [8.20] |
| | Double Row | .282 [7.16] .323 [8.20] |
| Flexible Flat Conductor Cable Receptacle with Multiple Crimp Standard Pressure Contact—Catalog 82007 | Single Row | .220 [5.59] .323 [8.20] |
| | Double Row | .235 [5.97] .323 [8.20] |

*Maximum post length is determined by customer's application; (i.e., available space beyond rear of horizontal receptacle assembly, or above bottom entry vertical receptacle assembly or below vertical receptacle assemblies used in pass through applications).

Parallel Stacking Guide for Board-to-Board Applications

| See Figure Below | Dimension Between PC Boards | Product Family Headers (See Note 1.) | Single-Row (Page Ref.) | Double-Row (Page Ref.) | Product Family Receptacles | Single-Row (Page Ref.) | Double-Row (Page Ref.) |
|------------------|-----------------------------|--|------------------------|------------------------|---|------------------------|----------------------------|
| | .060 [1.52] | Bandolier Posts | 163 | NA | Dual Entry, Mod IV | 177, 181, 187, 188 | 182-184, 189-192 |
| 1 | .090 [2.29] | Breakaway** (Unshrouded) | 102** | 104** | Dual Entry, Mod IV | 177, 181, 187, 188 | 182-184, 189-192 |
| | .153 [3.89] | Surface Mount** Breakaway (Unshrouded) | NA | 110 | Dual Entry, Mod IV | 177, 181, 187, 188 | 182-184, 189-192 |
| | .265 [6.73] | Bandolier Posts | 163 | 137** | Top Entry, Mod IV | 178, 181, 187, 188 | 179, 180, 182-184, 189-192 |
| 2 | .355 [9.02] | Breakaway** (Unshrouded) | 102** | 104** | Top Entry, Mod IV | 178, 181, 187, 188 | 179, 180, 182-184, 189-192 |
| | .385 [9.78] | Low Profile Shrouded | NA | 135, 137** | Top Entry, Mod IV | NA | 179, 180 |
| 3 | .418 [10.6] | Surface Mount** Breakaway (Unshrouded) | 109 | 110 | Surface Mount**, Mod IV, Top Entry | 187, 188 | 189-192 |
| 2* | .430 [10.92] | Breakaway** (Unshrouded) | 102** | 104** | Top Entry, Mod II | 175 | 176 |
| 4* | .440 [11.18] | Shrouded, Mod II | 115, 116 | 117, 119 | Top Entry, Mod II or Mod IV | 175, 178 | 176, 179, 180 |
| | .528 [13.41] | Stacking Shroud (See Note 2.) | NA | 156 (Hood) | Inner Board Receptacle (See Note 2.) | NA | 157 |
| | .547 [13.89] | Stacking Shroud (See Note 2.) | NA | 160 | Outer Board Receptacle (See Note 2.) | NA | 158 |
| 4 | .550 [13.97] | Two-Piece Header Connector System | NA | 198, 199 | Two-Piece Receptacle** Connector System | NA | 196** |
| | .748 [19.00] | Stacking Shroud (See Note 2.) | NA | 156 (Hood) | Inner Board Receptacle (See Note 2.) | NA | 157 |
| | .768 [19.51] | Stacking Shroud (See Note 2.) | NA | 161 | Outer Board Receptacle (See Note 2.) | NA | 158 |
| | Various | Stacking Unshrouded | 112 | 113 | Mod II/IV Receptacles, Top/Bottom Entry | Various | Various |

**High temperature version available, see page ref. listed.

Notes: 1. Headers listed are standard thru-hole versions. Many headers are available with retention feature and ACTION PIN posts. See product specification pages in individual sections for option availability.

2. These headers and receptacles are Related Board-to-Board products. They are not part of the AMPMODU .025 [0.64] Square Product Family.

Board-to-Board Stacking Heights (By Receptacle/Header Combination)

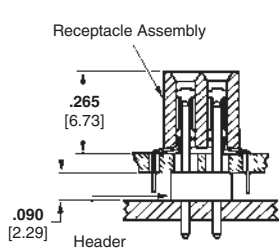

Figure 1
Double-Row, Mod IV, Bottom Entry, Breakaway Header

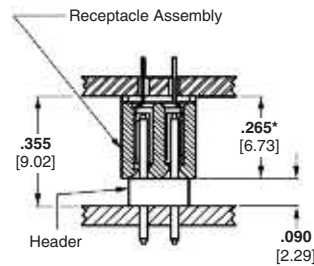

Figure 2
Double-Row, Mod IV, Top Entry, Breakaway Header
*Mod II Receptacle Height is .340 [8.64] for a total stack height of .430 [10.92]

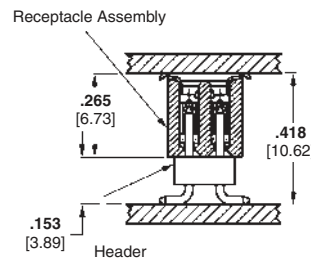

Figure 3
Double-Row, Mod IV, Surface-Mount, Top Entry, Receptacle and Surface-Mount Breakaway Header

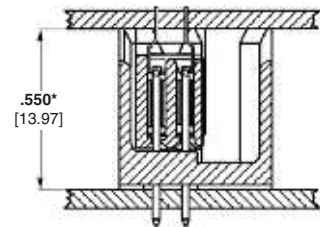
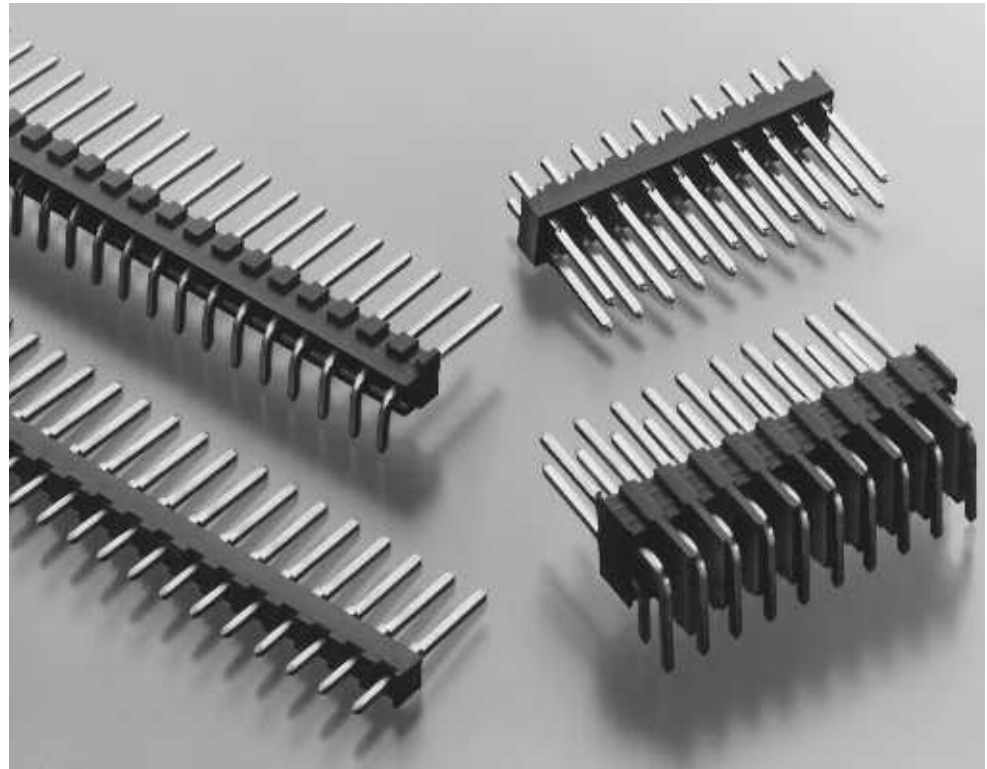

Figure 4
Double-Row, Two-Piece Receptacle and Two-Piece Shrouded Header
*Mod II Shrouded Header Height is .440 [11.18] for a total stack height of .440 [11.18]

Standard Headers—Unshrouded

Product Facts

- Variety of popular sizes available
- Substantial time/labor savings—install all posts at one time
- Vertical and right-angle versions available in single- and double-row configurations
- Triple-row version available in vertical configuration with .230 [5.84] mating length
- Copper alloy posts
- Choice of select gold or tin plated posts
- Mating length for single and double row is .318 [8.08] (.278 [7.06] effective mating length—see page 90)
- Flame retardant, black thermoplastic housings; 94V-0 rated
- Recognized under the Component Program of Underwriters Laboratories Inc., File No. E28476
- Certified by Canadian Standards Association, File No. LR 7189



Performance Characteristics

Electrical

Insulation Resistance — 5,000 megohms minimum initial

Dielectric Withstanding Voltage — 750 V rms at sea level

Environmental

Operating Temperature — -65°C to +105°C (black thermoplastic housings)

Current — 3 amperes maximum per contact (dependent upon mating connector)

Standard Headers—Unshrouded, Single Row, .100 [2.54] Centerline

.025 [0.64] Square Straight Post

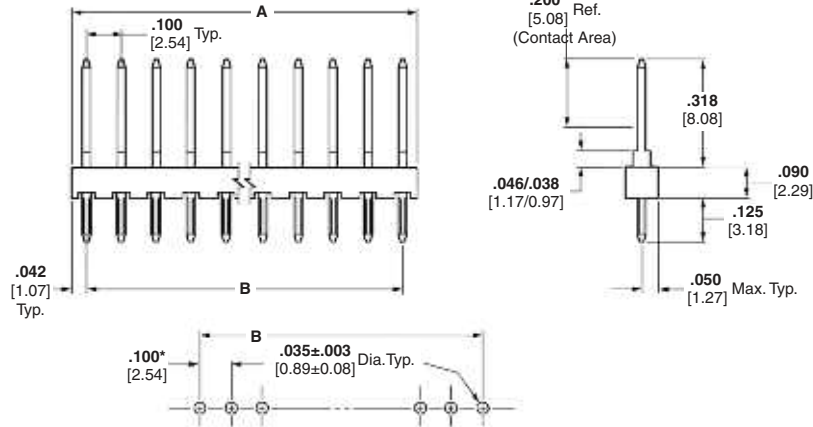

**Recommended PC Board Hole Layout
(for .055 [1.40] min. thick PC board)**

*±.003 [±0.08] tolerances not to accumulate within one connector pattern.

Material and Finish

Housing — Black thermoplastic, 94V-0 rated

Posts — Copper alloy, plated as follows:

Plating A — Selectively plated .000030 [0.00076] gold on contact area, with gold flash over .000050 [0.00127] nickel on entire post

Plating B — Selectively plated .000015 [0.00038] gold on contact area, with gold flash over .000050 [0.00127] nickel on entire post

Tin/Nickel — Plating option available; minimum order quantities may apply. Consult TE.

Related Product Data

Mateable Connectors — Refer to the Mating Post Selection Guide — page 90

Technical Documents — page 276

See mating connector for applicable product and application specifications.

| No. of Pos. | Dimensions | | Post Plating/Part Nos. | |
|-------------|----------------|---------------|------------------------|-----------|
| | A | B | Plating A | Plating B |
| 1 | .084 [2.13] | — | 87220-1 | 87224-1 |
| 2 | .184 [4.67] | .100 [2.54] | 87220-2 | 87224-2 |
| 3 | .284 [7.21] | .200 [5.08] | 87220-3 | 87224-3 |
| 4 | .384 [9.75] | .300 [7.62] | 87220-4 | 87224-4 |
| 5 | .484 [12.29] | .400 [10.16] | 87220-5 | 87224-5 |
| 6 | .584 [14.83] | .500 [12.70] | 87220-6 | 87224-6 |
| 7 | .684 [17.37] | .600 [15.24] | 87220-7 | 87224-7 |
| 8 | .784 [19.91] | .700 [17.78] | 87220-8 | 87224-8 |
| 9 | .884 [22.45] | .800 [20.32] | 87220-9 | 87224-9 |
| 10 | .984 [24.99] | .900 [22.86] | 1-87220-0 | 1-87224-0 |
| 11 | 1.084 [27.53] | 1.000 [25.40] | 1-87220-1 | 1-87224-1 |
| 12 | 1.184 [30.07] | 1.100 [27.94] | 1-87220-2 | 1-87224-2 |
| 13 | 1.284 [32.61] | 1.200 [30.48] | 1-87220-3 | 1-87224-3 |
| 14 | 1.384 [35.15] | 1.300 [33.02] | 1-87220-4 | 1-87224-4 |
| 15 | 1.484 [37.69] | 1.400 [35.56] | 1-87220-5 | 1-87224-5 |
| 16 | 1.584 [40.23] | 1.500 [38.10] | 1-87220-6 | 1-87224-6 |
| 17 | 1.684 [42.77] | 1.600 [40.64] | 1-87220-7 | 1-87224-7 |
| 18 | 1.784 [45.31] | 1.700 [43.18] | 1-87220-8 | 1-87224-8 |
| 19 | 1.884 [47.85] | 1.800 [45.72] | 1-87220-9 | 1-87224-9 |
| 20 | 1.984 [50.39] | 1.900 [48.26] | 2-87220-0 | 2-87224-0 |
| 21 | 2.084 [52.93] | 2.000 [50.80] | 2-87220-1 | 2-87224-1 |
| 22 | 2.184 [55.47] | 2.100 [53.34] | 2-87220-2 | 2-87224-2 |
| 23 | 2.284 [58.01] | 2.200 [55.88] | 2-87220-3 | 2-87224-3 |
| 24 | 2.384 [60.55] | 2.300 [58.42] | 2-87220-4 | 2-87224-4 |
| 25 | 2.484 [63.09] | 2.400 [60.96] | 2-87220-5 | 2-87224-5 |
| 26 | 2.584 [65.63] | 2.500 [63.50] | 2-87220-6 | 2-87224-6 |
| 27 | 2.684 [68.17] | 2.600 [66.04] | 2-87220-7 | 2-87224-7 |
| 28 | 2.784 [70.71] | 2.700 [68.58] | 2-87220-8 | 2-87224-8 |
| 29 | 2.884 [73.25] | 2.800 [71.12] | 2-87220-9 | 2-87224-9 |
| 30 | 2.984 [75.79] | 2.900 [73.66] | 3-87220-0 | 3-87224-0 |
| 31 | 3.084 [78.33] | 3.000 [76.20] | 3-87220-1 | 3-87224-1 |
| 32 | 3.184 [80.87] | 3.100 [78.74] | 3-87220-2 | 3-87224-2 |
| 33 | 3.284 [83.41] | 3.200 [81.28] | 3-87220-3 | 3-87224-3 |
| 34 | 3.384 [85.95] | 3.300 [83.82] | 3-87220-4 | 3-87224-4 |
| 35 | 3.484 [88.49] | 3.400 [86.36] | 3-87220-5 | 3-87224-5 |
| 36 | 3.584 [91.03] | 3.500 [88.90] | 3-87220-6 | 3-87224-6 |
| 37 | 3.684 [93.57] | 3.600 [91.44] | 3-87220-7 | 3-87224-7 |
| 38 | 3.784 [96.11] | 3.700 [93.98] | 3-87220-8 | 3-87224-8 |
| 39 | 3.884 [98.65] | 3.800 [96.52] | 3-87220-9 | 3-87224-9 |
| 40 | 3.984 [101.19] | 3.900 [99.06] | 4-87220-0 | 4-87224-0 |

Note: All part numbers are RoHS compliant.

Standard Headers—Unshrouded, Single Row, .100 [2.54] Centerline (Continued)

.025 [0.64] Square Right-Angle Post

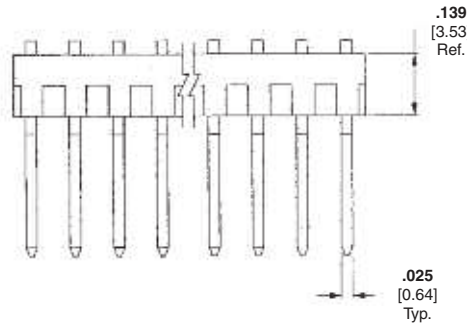

Material and Finish

Housing — Black thermoplastic, 94V-0 rated

Posts — Copper alloy, plated as follows:

Plating A — Selectively plated .000030 [0.00076] gold on contact area, with gold flash over .000050 [0.00127] nickel on entire post

Plating B — Selectively plated .000015 [0.00038] gold on contact area, with gold flash over .000050 [0.00127] nickel on entire post

Tin/Nickel — Plating option available; minimum order quantities may apply. Consult TE.

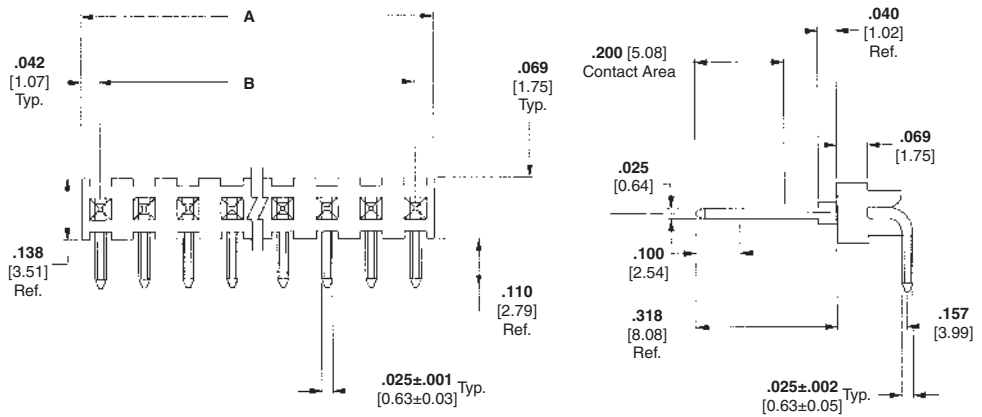

Related Product Data

Mateable Connectors — Refer to the Mating Post Selection Guide — page 90



Recommended PC Board Hole Layout
(for .055 [1.40] min. thick PC board)

*±.003 [±0.08] tolerances not to accumulate within one connector pattern.

Technical Documents — page 276

See mating connector for applicable product and application specifications.

| No. of Pos. | Dimensions | | Post Plating/Part Nos. | |
|-------------|---------------|---------------|------------------------|-----------|
| | A | B | Plating A | Plating B |
| 1 | .084 [2.13] | — | 87232-1 | 87233-1 |
| 2 | .184 [4.67] | .100 [2.54] | 87232-2 | 87233-2 |
| 3 | .284 [7.21] | .200 [5.08] | 87232-3 | 87233-3 |
| 4 | .384 [9.75] | .300 [7.62] | 87232-4 | 87233-4 |
| 5 | .484 [12.29] | .400 [10.16] | 87232-5 | 87233-5 |
| 6 | .584 [14.83] | .500 [12.70] | 87232-6 | 87233-6 |
| 7 | .684 [17.37] | .600 [15.24] | 87232-7 | 87233-7 |
| 8 | .784 [19.91] | .700 [17.78] | 87232-8 | 87233-8 |
| 9 | .884 [22.45] | .800 [20.32] | 87232-9 | 87233-9 |
| 10 | .984 [24.99] | .900 [22.86] | 1-87232-0 | 1-87233-0 |
| 11 | 1.084 [27.53] | 1.000 [25.40] | 1-87232-1 | 1-87233-1 |
| 12 | 1.184 [30.07] | 1.100 [27.94] | 1-87232-2 | 1-87233-2 |
| 13 | 1.284 [32.61] | 1.200 [30.48] | 1-87232-3 | 1-87233-3 |
| 14 | 1.384 [35.15] | 1.300 [33.02] | 1-87232-4 | 1-87233-4 |
| 15 | 1.484 [37.69] | 1.400 [35.56] | 1-87232-5 | 1-87233-5 |
| 16 | 1.584 [40.23] | 1.500 [38.10] | 1-87232-6 | 1-87233-6 |
| 17 | 1.684 [42.77] | 1.600 [40.64] | 1-87232-7 | 1-87233-7 |
| 18 | 1.784 [45.31] | 1.700 [43.18] | 1-87232-8 | 1-87233-8 |
| 19 | 1.884 [47.85] | 1.800 [45.72] | 1-87232-9 | 1-87233-9 |
| 20 | 1.984 [50.39] | 1.900 [48.26] | 2-87232-0 | 2-87233-0 |

Note: All part numbers are RoHS compliant.

Standard Headers—Unshrouded, Single Row, .100 [2.54] Centerline (Continued)

| No. of Pos. | Dimensions | | Post Plating/Part Nos. | |
|-------------|-----------------------|----------------------|------------------------|-----------|
| | A | B | Plating A | Plating B |
| 21 | 2.084 [52.93] | 2.000 [50.80] | 2-87232-1 | 2-87233-1 |
| 22 | 2.184 [55.47] | 2.100 [53.34] | 2-87232-2 | 2-87233-2 |
| 23 | 2.284 [58.01] | 2.200 [55.88] | 2-87232-3 | 2-87233-3 |
| 24 | 2.384 [60.55] | 2.300 [58.42] | 2-87232-4 | 2-87233-4 |
| 25 | 2.484 [63.09] | 2.400 [60.96] | 2-87232-5 | 2-87233-5 |
| 26 | 2.584 [65.63] | 2.500 [63.50] | 2-87232-6 | 2-87233-6 |
| 27 | 2.684 [68.17] | 2.600 [66.04] | 2-87232-7 | 2-87233-7 |
| 28 | 2.784 [70.71] | 2.700 [68.58] | 2-87232-8 | 2-87233-8 |
| 29 | 2.884 [73.25] | 2.800 [71.12] | 2-87232-9 | 2-87233-9 |
| 30 | 2.984 [75.79] | 2.900 [73.66] | 3-87232-0 | 3-87233-0 |
| 31 | 3.084 [78.33] | 3.000 [76.20] | 3-87232-1 | 3-87233-1 |
| 32 | 3.184 [80.87] | 3.100 [78.74] | 3-87232-2 | 3-87233-2 |
| 33 | 3.284 [83.41] | 3.200 [81.28] | 3-87232-3 | 3-87233-3 |
| 34 | 3.385 [85.95] | 3.300 [83.82] | 3-87232-4 | 3-87233-4 |
| 35 | 3.484 [88.49] | 3.400 [86.36] | 3-87232-5 | 3-87233-5 |
| 36 | 3.584 [91.03] | 3.500 [88.90] | 3-87232-6 | 3-87233-6 |
| 37 | 3.684 [93.57] | 3.600 [91.44] | 3-87232-7 | 3-87233-7 |
| 38 | 3.784 [96.11] | 3.700 [93.98] | 3-87232-8 | 3-87233-8 |
| 39 | 3.884 [98.65] | 3.800 [96.52] | 3-87232-9 | 3-87233-9 |
| 40 | 3.984 [101.19] | 3.900 [99.06] | 4-87232-0 | 4-87233-0 |

Note: All part numbers are RoHS compliant.

Standard Headers—Unshrouded, Double-Row, .100 x .100 [2.54 x 2.54] Centerline

.025 [0.64] Square Straight Post

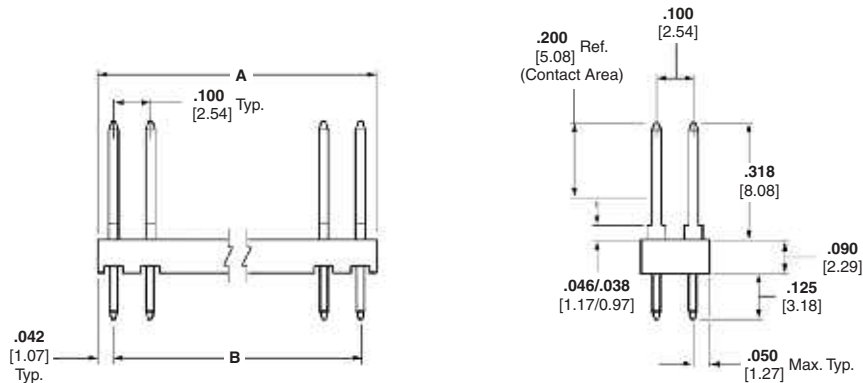

Material and Finish

Housing — Black thermoplastic, 94V-0 rated

Posts — Copper alloy, plated as follows:

Plating A — Selectively plated .000030 [0.00076] gold on contact area, with gold flash over .000050 [0.00127] nickel on entire post

Plating B — Selectively plated .000015 [0.00038] gold on contact area, with gold flash over .000050 [0.00127] nickel on entire post

Tin/Nickel — Plating option available; minimum order quantities may apply. Consult TE.

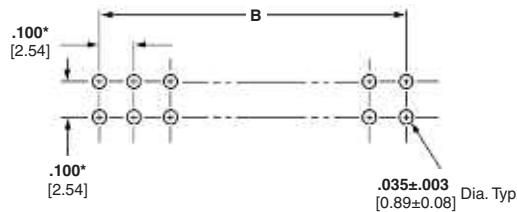

Recommended PC Board Hole Layout (for .055 [1.40] min. thick PC board)

*±.003 [±0.08] tolerances not to accumulate within one connector pattern.

Related Product Data

Mateable Connectors — Refer to the Mating Post Selection Guide — page 90

Accessories

Barrier Insert — page 204

Technical Documents — page 276

See mating connector for applicable product and application specifications.

| No. of Pos. | Dimensions | | Post Plating/Part Nos. | |
|-------------|---------------|---------------|------------------------|-----------|
| | A | B | Plating A | Plating B |
| 2 | .084 [2.13] | — | 1-87215-0 | 87227-1 |
| 4 | .184 [4.67] | .100 [2.54] | 1-87215-1 | 87227-2 |
| 6 | .284 [7.21] | .200 [5.08] | 1-87215-2 | 87227-3 |
| 8 | .384 [9.75] | .300 [7.62] | 87215-1 | 87227-4 |
| 10 | .484 [12.29] | .400 [10.16] | 87215-2 | 87227-5 |
| 12 | .584 [14.83] | .500 [12.70] | 87215-3 | 87227-6 |
| 14 | .684 [17.37] | .600 [15.24] | 87215-4 | 87227-7 |
| 16 | .784 [19.91] | .700 [17.78] | 87215-5 | 87227-8 |
| 18 | .884 [22.45] | .800 [20.32] | 87215-6 | 87227-9 |
| 20 | .984 [24.99] | .900 [22.86] | 87215-7 | 1-87227-0 |
| 22 | 1.084 [27.53] | 1.000 [25.40] | 1-87215-3 | 1-87227-1 |
| 24 | 1.184 [30.07] | 1.100 [27.94] | 87215-8 | 1-87227-2 |
| 26 | 1.284 [32.61] | 1.200 [30.48] | 87215-9 | 1-87227-3 |
| 28 | 1.384 [35.15] | 1.300 [33.02] | 1-87215-4 | 1-87227-4 |
| 30 | 1.484 [37.69] | 1.400 [35.56] | 1-87215-5 | 1-87227-5 |
| 32 | 1.584 [40.23] | 1.500 [38.10] | 1-87215-6 | 1-87227-6 |
| 34 | 1.684 [42.77] | 1.600 [40.64] | 1-87215-7 | 1-87227-7 |
| 36 | 1.784 [45.31] | 1.700 [43.18] | 1-87215-8 | 1-87227-8 |
| 38 | 1.884 [47.85] | 1.800 [45.72] | 1-87215-9 | 1-87227-9 |
| 40 | 1.984 [50.39] | 1.900 [48.26] | 2-87215-0 | 2-87227-0 |

Note: All part numbers are RoHS compliant.

**Standard Headers—Unshrouded, Double-Row,
.100 x .100 [2.54 x 2.54] Centerline** (Continued)

| No. of Pos. | Dimensions | | Post Plating/Part Nos. | |
|-------------|-----------------------|----------------------|------------------------|-----------|
| | A | B | Plating A | Plating B |
| 42 | 2.084 [52.93] | 2.000 [50.80] | 2-87215-1 | 2-87227-1 |
| 44 | 2.184 [55.47] | 2.100 [53.34] | 2-87215-2 | 2-87227-2 |
| 46 | 2.284 [58.01] | 2.200 [55.88] | 2-87215-3 | 2-87227-3 |
| 48 | 2.384 [60.55] | 2.300 [58.42] | 2-87215-4 | 2-87227-4 |
| 50 | 2.484 [63.09] | 2.400 [60.96] | 2-87215-5 | 2-87227-5 |
| 52 | 2.584 [65.63] | 2.500 [63.50] | 2-87215-6 | 2-87227-6 |
| 54 | 2.684 [68.17] | 2.600 [66.04] | 2-87215-7 | 2-87227-7 |
| 56 | 2.784 [70.71] | 2.700 [68.58] | 2-87215-8 | 2-87227-8 |
| 58 | 2.884 [73.25] | 2.800 [71.12] | 2-87215-9 | 2-87227-9 |
| 60 | 2.984 [75.79] | 2.900 [73.66] | 3-87215-0 | 3-87227-0 |
| 62 | 3.084 [78.33] | 3.000 [76.20] | 3-87215-1 | 3-87227-1 |
| 64 | 3.184 [80.87] | 3.100 [78.74] | 3-87215-2 | 3-87227-2 |
| 66 | 3.284 [83.41] | 3.200 [81.28] | 3-87215-3 | 3-87227-3 |
| 68 | 3.384 [85.95] | 3.300 [83.82] | 3-87215-4 | 3-87227-4 |
| 70 | 3.484 [88.49] | 3.400 [86.36] | 3-87215-5 | 3-87227-5 |
| 72 | 3.584 [91.03] | 3.500 [88.90] | 3-87215-6 | 3-87227-6 |
| 74 | 3.684 [93.57] | 3.600 [91.44] | 3-87215-7 | 3-87227-7 |
| 76 | 3.784 [96.11] | 3.700 [93.98] | 3-87215-8 | 3-87227-8 |
| 78 | 3.884 [98.65] | 3.800 [96.52] | 3-87215-9 | 3-87227-9 |
| 80 | 3.984 [101.19] | 3.900 [99.06] | 4-87215-0 | 4-87227-0 |

Note: All part numbers are RoHS compliant.

Standard Headers—Unshrouded, Double-Row, .100 x .100 [2.54 x 2.54] Centerline (Continued)

.025 [0.64] Square Right-Angle Post



Material and Finish

Housing — Black thermoplastic, 94V-0 rated

Posts — Copper alloy, plated as follows:

Plating A — Selectively plated .000030 [0.00076] gold on contact area, with gold flash over .000050 [0.00127] nickel on entire post

Plating B — Selectively plated .000015 [0.00038] gold on contact area, with gold flash over .000050 [0.00127] nickel on entire post

Tin/Nickel — Plating option available; minimum order quantities may apply. Consult TE.

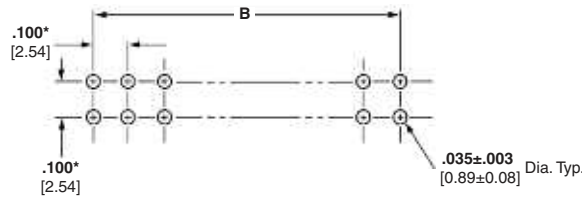
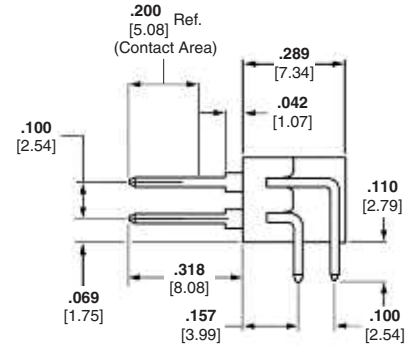
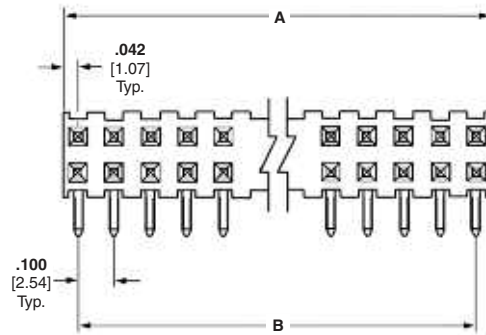

Recommended PC Board Hole Layout (for .055 [1.40] min. thick PC board)

*±.003 [±0.08] tolerances not to accumulate within one connector pattern.

Related Product Data

Mateable Connectors — Refer to the Mating Post Selection Guide — page 90

Technical Documents — page 276

See mating connector for applicable product and application specifications.

| No. of Pos. | Dimensions | | Post Plating/Part Nos. | |
|-------------|---------------|---------------|------------------------|-----------|
| | A | B | Plating A | Plating B |
| 2 | .084 [2.13] | — | 1-86479-3 | 87230-1 |
| 4 | .184 [4.67] | .100 [2.54] | 1-86479-4 | 87230-2 |
| 6 | .284 [7.21] | .200 [5.08] | 1-86479-5 | 87230-3 |
| 8 | .384 [9.75] | .300 [7.62] | 1-86479-6 | 87230-4 |
| 10 | .484 [12.29] | .400 [10.16] | 86479-3 | 87230-5 |
| 12 | .584 [14.83] | .500 [12.70] | 86479-4 | 87230-6 |
| 14 | .684 [17.37] | .600 [15.24] | 86479-5 | 87230-7 |
| 16 | .784 [19.91] | .700 [17.78] | 86479-2 | 87230-8 |
| 18 | .884 [22.45] | .800 [20.32] | 86479-6 | 87230-9 |
| 20 | .984 [24.99] | .900 [22.86] | 86479-1 | 1-87230-0 |
| 22 | 1.084 [27.53] | 1.000 [25.40] | 1-86479-7 | 1-87230-1 |
| 24 | 1.184 [30.07] | 1.100 [27.94] | 86479-7 | 1-87230-2 |
| 26 | 1.284 [32.61] | 1.200 [30.48] | 1-86479-0 | 1-87230-3 |
| 28 | 1.384 [35.15] | 1.300 [33.02] | 1-86479-8 | 1-87230-4 |
| 30 | 1.484 [37.69] | 1.400 [35.56] | 1-86479-9 | 1-87230-5 |
| 32 | 1.584 [40.23] | 1.500 [38.10] | 2-86479-0 | 1-87230-6 |
| 34 | 1.684 [42.77] | 1.600 [40.64] | 2-86479-1 | 1-87230-7 |
| 36 | 1.784 [45.31] | 1.700 [43.18] | 2-86479-2 | 1-87230-8 |
| 38 | 1.884 [47.85] | 1.800 [45.72] | 2-86479-3 | 1-87230-9 |
| 40 | 1.984 [50.39] | 1.900 [48.26] | 2-86479-4 | 2-87230-0 |

Note: All part numbers are RoHS compliant.

**Standard Headers—Unshrouded, Double-Row,
.100 x .100 [2.54 x 2.54] Centerline** (Continued)

| No. of Pos. | Dimensions | | Post Plating/Part Nos. | |
|-------------|----------------|---------------|------------------------|-----------|
| | A | B | Plating A | Plating B |
| 42 | 2.084 [52.93] | 2.000 [50.80] | 2-86479-5 | 2-87230-1 |
| 44 | 2.184 [55.47] | 2.100 [53.34] | 2-86479-6 | 2-87230-2 |
| 46 | 2.284 [58.01] | 2.200 [55.88] | 2-86479-7 | 2-87230-3 |
| 48 | 2.384 [60.55] | 2.300 [58.42] | 2-86479-8 | 2-87230-4 |
| 50 | 2.484 [63.09] | 2.400 [60.96] | 2-86479-9 | 2-87230-5 |
| 52 | 2.584 [65.63] | 2.500 [63.50] | 3-86479-0 | 2-87230-6 |
| 54 | 2.684 [68.17] | 2.600 [66.04] | 3-86479-1 | 2-87230-7 |
| 56 | 2.784 [70.71] | 2.700 [68.58] | 3-86479-2 | 2-87230-8 |
| 58 | 2.884 [73.25] | 2.800 [71.12] | 3-86479-3 | 2-87230-9 |
| 60 | 2.984 [75.79] | 2.900 [73.66] | 3-86479-4 | 3-87230-0 |
| 62 | 3.084 [78.33] | 3.000 [76.20] | 3-86479-5 | 3-87230-1 |
| 64 | 3.184 [80.87] | 3.100 [78.74] | 3-86479-6 | 3-87230-2 |
| 66 | 3.284 [83.41] | 3.200 [81.28] | 3-86479-7 | 3-87230-3 |
| 68 | 3.384 [85.95] | 3.300 [83.82] | 3-86479-8 | 3-87230-4 |
| 70 | 3.484 [88.49] | 3.400 [86.36] | 3-86479-9 | 3-87230-5 |
| 72 | 3.584 [91.03] | 3.500 [88.90] | 4-86479-0 | 3-87230-6 |
| 74 | 3.684 [93.57] | 3.600 [91.44] | 4-86479-1 | 3-87230-7 |
| 76 | 3.784 [96.11] | 3.700 [93.98] | 4-86479-2 | 3-87230-8 |
| 78 | 3.884 [98.65] | 3.800 [96.52] | 4-86479-3 | 3-87230-9 |
| 80 | 3.984 [101.19] | 3.900 [99.06] | 4-86479-4 | 4-87230-0 |

Note: All part numbers are RoHS compliant.

Standard Headers—Unshrouded, Triple-Row, .100 [2.54] Centerline

.025 [0.64] Square Straight Post

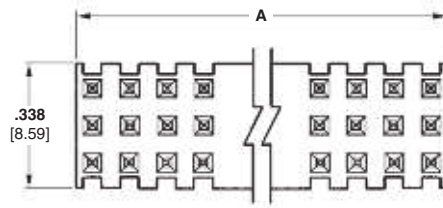

Material and Finish

Housing — Black thermoplastic, 94V-0 rated

Posts — Phosphor bronze, duplex plated 000030 [0.00076] gold on contact area, .000100-.000200 [0.00254-0.00508] tin on solder area, with entire post underplated .000050 [0.00127] nickel

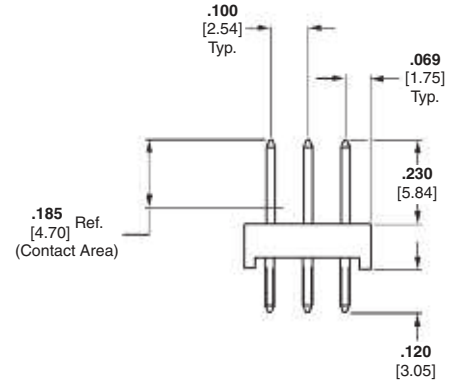
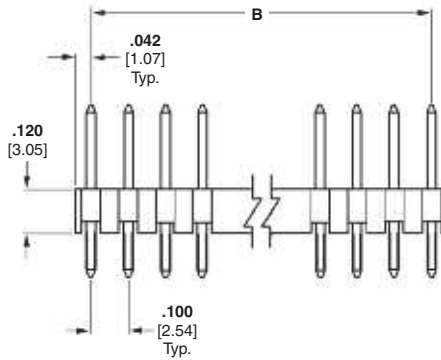

Technical Documents — page 276

See mating connector for applicable product and application specifications.

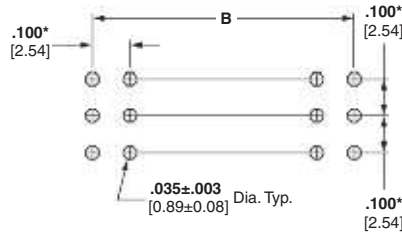

Recommended PC Board Hole Layout (for .055 [1.40] min. thick PC board)

*±.003 [±0.08] tolerances not to accumulate within one connector pattern.

Unshrouded Headers



5

| No. of Pos. | Dimensions | | Part Nos. |
|-------------|----------------|---------------|------------|
| | A | B | |
| 9 | .284 [7.21] | .200 [5.08] | 5-103817-1 |
| 12 | .384 [9.75] | .300 [7.62] | 5-103817-2 |
| 15 | .484 [12.29] | .400 [10.16] | 5-103817-3 |
| 18 | .584 [14.83] | .500 [12.70] | 5-103817-4 |
| 21 | .684 [17.37] | .600 [15.24] | 5-103817-5 |
| 24 | .784 [19.91] | .700 [17.78] | 5-103817-6 |
| 27 | .884 [22.45] | .800 [20.32] | 5-103817-7 |
| 30 | .984 [24.99] | .900 [22.86] | 5-103817-8 |
| 33 | 1.084 [27.53] | 1.000 [25.40] | 5-103817-9 |
| 42 | 1.384 [35.15] | 1.300 [33.02] | 6-103817-2 |
| 45 | 1.484 [37.69] | 1.400 [35.56] | 6-103817-3 |
| 60 | 1.984 [50.39] | 1.900 [48.26] | 6-103817-8 |
| 69 | 2.284 [58.01] | 2.200 [55.88] | 7-103817-1 |
| 72 | 2.384 [60.55] | 2.300 [58.42] | 7-103817-2 |
| 96 | 3.184 [80.87] | 3.100 [78.74] | 8-103817-0 |
| 120 | 3.984 [101.19] | 3.900 [99.06] | 8-103817-8 |

Note: All part numbers are RoHS compliant.

Breakaway and Retention Headers—Unshrouded

Product Facts

- Design and inventory versatility—headers can be broken into any size needed
- Variety of popular sizes available
- Substantial time/labor savings can install all posts at one time
- Vertical and right-angle versions available in single- and double-row configurations
- Phosphor bronze posts
- Choice of gold duplex or tin plated posts
- Post lengths include .230 [5.84] and .318 [8.08] for connector mating
- Board retention feature available
- Black, glass-filled thermoplastic housings; high temperature compatible
- Recognized under the Component Program of Underwriters Laboratories Inc., File No. E28476 
- Certified by Canadian Standards Association, File No. LR 7189 



Performance Characteristics

Electrical

Insulation Resistance — 5,000 megohms minimum initial

Dielectric Withstanding Voltage — 750 V rms at sea level

Environmental

Operating Temperature — -65°C to +105°C (black thermoplastic housings)

Current — 3 amperes maximum per contact (dependent upon mating receptacle)

Breakaway Headers—Unshrouded, Single-Row, .100 [2.54] Centerline

.025 [0.64] Square Straight Posts



Material and Finish

Housing — Black thermoplastic, 94V-0 rated, high temperature compatible

Posts — Phosphor bronze, plated as follows:

Plating A — Duplex plated .000030 [0.00076] gold on contact area, .000100-.000200 [0.00254-0.00508] tin on solder tail, with entire post underplated .000050 [0.00127] nickel

Plating B — Duplex plated .000015 [0.00038] gold on contact area, .000100-.000200 [0.00254-0.00508] tin on solder tail, with entire post underplated .000050 [0.00127] nickel

Plating C — .000100-.000200 [0.00254-0.00508] tin over .000050 [0.00127] nickel

Performance Characteristics (Board Retention Tails)

Insertion Force — 12 lb [53.4N] max.

Retention Force — .25 lb [1.11N] min.

Related Product Data

Mateable Connectors — Refer to the Mating Post Selection Guide — page 90

Technical Documents — page 276

See mating connector for applicable product and application specifications.

Headers with Solder Tails

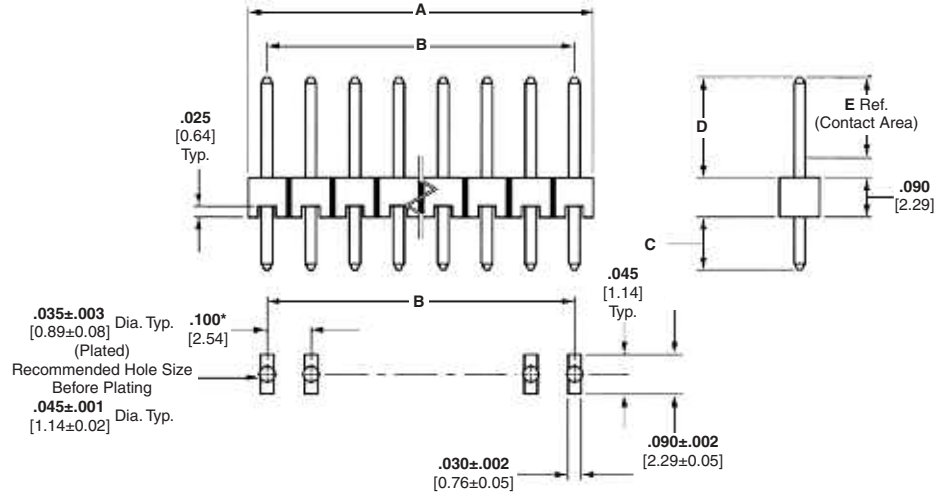

Recommended PC Board Mounting Pattern (for .062 [1.57] thick PC board; .008 [2.03] thick stencil)

*±.003 [±0.08] tolerances not to accumulate within one connector pattern.

Headers with Board Retention Tails

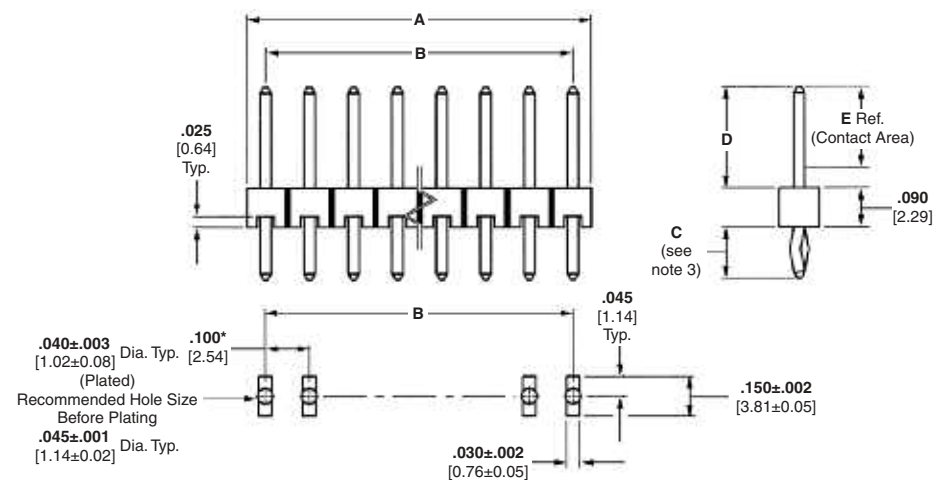

Recommended PC Board Mounting Pattern (for .062 [1.57] thick PC board; .008 [2.03] thick stencil)

*±.003 [±0.08] tolerances not to accumulate within one connector pattern.

| Header Style | No. of Pos. | Dimensions | | C = .090 [2.29] D = .230 [5.84] E = .185 [4.70] | | | C = .120 [3.05] D = .230 [5.84] E = .185 [4.70] | | | C = .125 [3.18] D = .318 [8.08] E = .200 [5.08] | | |
|---|-------------|----------------|---------------|---|------------|------------|---|------------|------------|---|------------|------------|
| | | A | B | Post Plating/Part Nos. | | | Post Plating/Part Nos. | | | Post Plating/Part Nos. | | |
| | | | | Plating A | Plating B | Plating C | Plating A | Plating B | Plating C | Plating A | Plating B | Plating C |
| With Solder Tails (See Notes 1 and 2.) | 1 | .084 [2.13] | — | 5-146285-1 | 5-146284-1 | 5-146282-1 | 5-146281-1 | 5-146280-1 | 5-146278-1 | 5-146277-1 | 5-146276-1 | 5-146274-1 |
| | 40 | 3.984 [101.19] | 3.900 [99.06] | 9-146285-0 | 9-146284-0 | 9-146282-0 | 9-146281-0 | 9-146280-0 | 9-146278-0 | 9-146277-0 | 9-146276-0 | 9-146274-0 |
| With Board Retention Tails (See Notes 2 and 3.) | 3 | .284 [7.21] | .200 [5.08] | 5-146297-3 | 5-146296-3 | 5-146294-3 | 5-146293-3 | 5-146292-3 | 5-146290-3 | 5-146289-3 | 5-146288-3 | 5-146286-3 |
| | 40 | 3.984 [101.19] | 3.900 [99.06] | 9-146297-0 | 9-146296-0 | 9-146294-0 | 9-146293-0 | 9-146292-0 | 9-146290-0 | 9-146289-0 | 9-146288-0 | 9-146286-0 |

- Notes:** 1. Headers without retention tails may be broken to the desired number of positions using **Tool Kit No. 314818-1 (not shown)**.
 2. Headers are also available in sizes 2 thru 39 positions (with Solder Tails) and 4 thru 39 positions (with Board Retention Tails). When ordering, add the prefix and/or suffix (dash) numbers plus 5- -0 to the base part number that corresponds with the desired size. For example, the complete part number for an 8-position header with solder tails (C dimension .090 [2.29], post plating A) would be 5-146285-8. The complete part number for a 26-position header with board retention tails (C dimension .120 [3.05], post plating B) would be 7-146292-6. This part numbering system applies only to this page.
 3. For C dimensions .120 [3.05] and .125 [3.18], board retention using kinked tails are for headers 6 positions and smaller; headers 7 positions and larger use swaged tails. Headers with a C dimension of .090 [2.29] have swaged tails for all sizes.

Note: All part numbers are RoHS compliant.

Breakaway Headers—Unshrouded, Single-Row, .100 [2.54] Centerline (Continued)

.025 [0.64] Square Right-Angle Posts



Material and Finish

Housing — Black thermoplastic, 94V-0 rated, high temperature compatible

Posts — Phosphor bronze, duplex plated .000030 [0.00076] gold on contact area, .000100-.000200 [0.00254-0.00508] matte tin on solder tail, with entire post underplated .000050 [0.00127] nickel

Performance Characteristics (Board Retention Tails)

Insertion Force — 12 lb [53.4N] max.

Retention Force — .25 lb [1.11N] min.

Related Product Data

Mateable Connectors — Refer to the Mating Post Selection Guide — page 90

Technical Documents — page 276

See mating connector for applicable product and application specifications.

Headers with Solder Tails

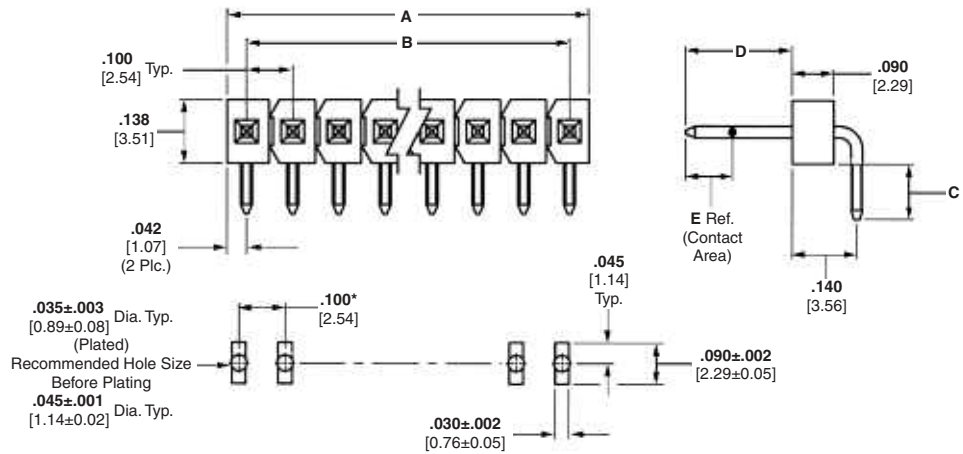

Recommended PC Board Mounting Pattern
(for .062 [1.57] thick PC board; .008 [.203] thick stencil)
*±.003 [±0.08] tolerances not to accumulate within one connector pattern.

Headers with Board Retention Tails

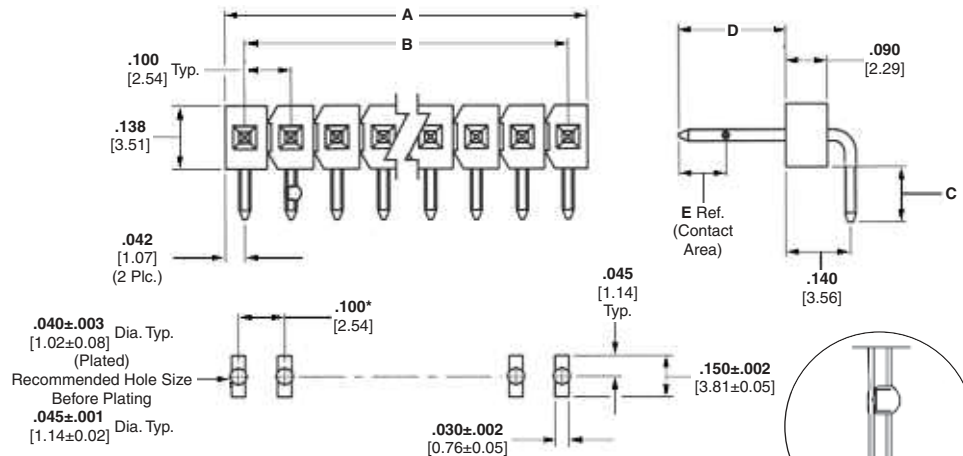

Recommended PC Board Mounting Pattern
(for .062 [1.57] thick PC board; .008 [.203] thick stencil)
*±.003 [±0.08] tolerances not to accumulate within one connector pattern.

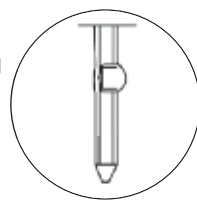

Board Retention Tail using Swaged Tails (All Header Sizes)

| Header Style | No. of Pos. | Dimensions | | Part Nos. | |
|--|-------------|----------------|---------------|---|---|
| | | A | B | C = .120 [3.05] D = .230 [5.84] E = .185 [4.70] | C = .110 [2.79] D = .318 [8.08] E = .200 [5.08] |
| With Solder Tails (See Notes 1 and 2.) | 1 | .084 [2.13] | — | 5-146304-1 | 5-146305-1 |
| | 40 | 3.984 [101.19] | 3.900 [99.06] | 9-146304-0 | 9-146305-0 |
| With Board Retention Tails (See Note 2.) | 3 | .084 [2.13] | — | 5-146306-3 | 5-146307-3 |
| | 40 | 3.984 [101.19] | 3.900 [99.06] | 9-146306-0 | 9-146307-0 |

Notes: 1. Headers without retention tails may be broken to the desired number of positions using **Tool Kit No. 314818-1 (not shown)**.
2. Headers are also available in sizes 2 thru 39 positions (with Solder Tails) and 4 thru 39 positions (with Board Retention Tails).
When ordering, add the prefix and/or suffix (dash) numbers plus 5- -0 to the base part number that corresponds with the number of positions. For example, the complete part number for an 8-position header with solder tails (C dimension .120 [3.05]) would be 5-146304-8. The complete part number for a 26-position header with board retention tails (C dimension .120 [3.05]) would be 7-146306-6. This part numbering system applies only to this page.

Note: All part numbers are RoHS compliant.

Breakaway Headers—Unshrouded, Double-Row, .100 x .100 [2.54 x 2.54] Centerline

.025 [0.64] Square Straight Posts



Material and Finish

Housing — Black thermoplastic, 94V-0 rated, high temperature compatible

Posts — Phosphor bronze, plated as follows:

Plating A — Duplex plated .000030 [0.00076] gold on contact area, .000100-.000200 [0.00254-0.00508] tin on solder tail, with entire post underplated .000050 [0.00127] nickel

Plating B — Duplex plated .000015 [0.00038] gold on contact area, .000100-.000200 [0.00254-0.00508] tin on solder tail, with entire post underplated .000050 [0.00127] nickel

Plating C — .000100-.000200 [0.00254-0.00508] tin over .000050 [0.00127] nickel

Performance Characteristics (Board Retention Tails)

Insertion Force — 12 lb [53.4N] max.
Retention Force — .25 lb [1.11N] min.

Related Product Data

Mateable Connectors — Refer to the Mating Post Selection Guide — page 90

Technical Documents — page 276

See mating connector for applicable product and application specifications.

Headers with Solder Tails

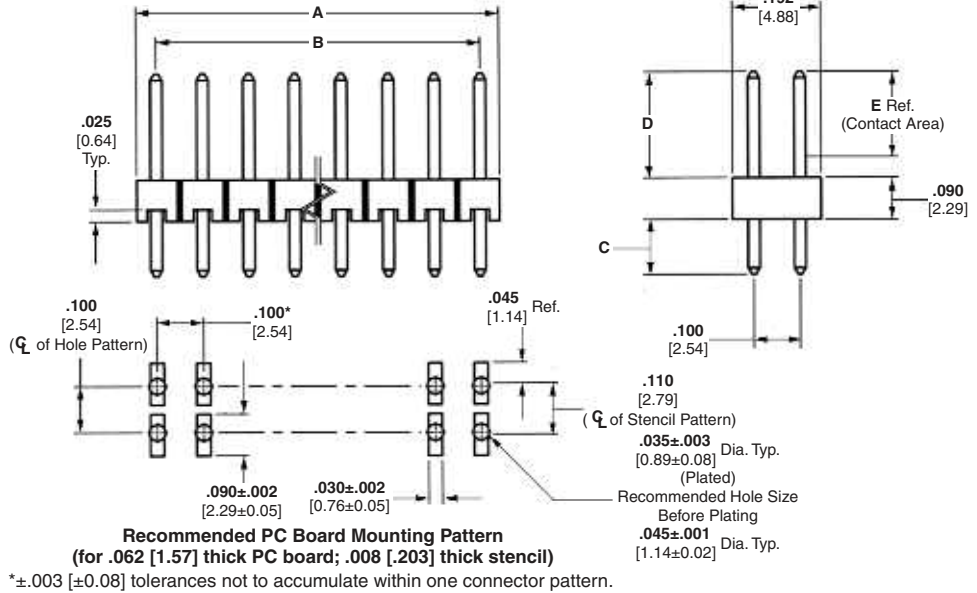

Headers with Board Retention Tails

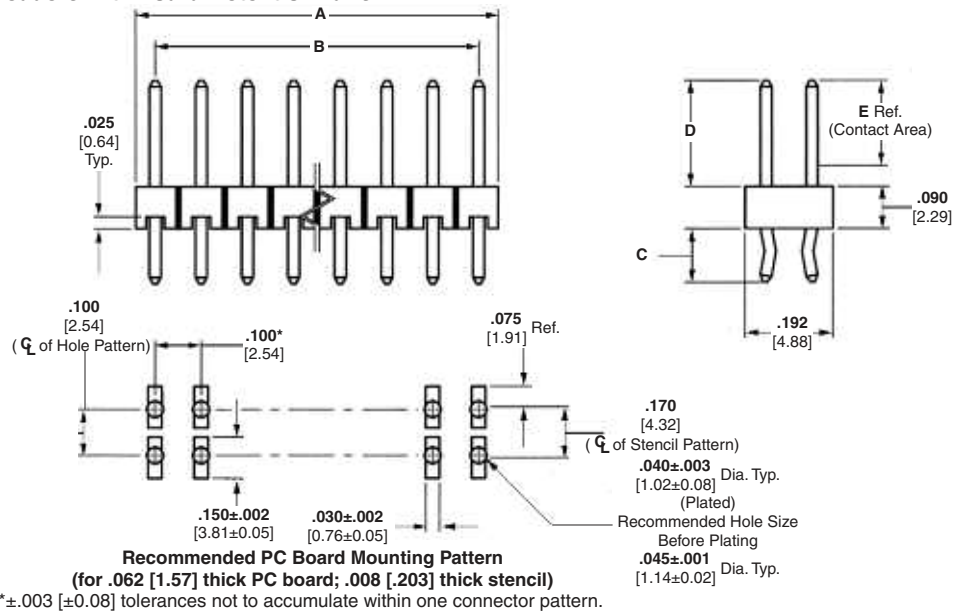

| Header Style | No. of Pos. | Dimensions | | C = .090 [2.29] D = .230 [5.84] E = .185 [4.70] | | | C = .120 [3.05] D = .230 [5.84] E = .185 [4.70] | | | C = .125 [3.18] D = .318 [8.08] E = .200 [5.08] | | |
|--|-------------|----------------|---------------|---|------------|------------|---|------------|------------|---|------------|------------|
| | | A | B | Post Plating/Part Nos. | | | Post Plating/Part Nos. | | | Post Plating/Part Nos. | | |
| | | | | Plating A | Plating B | Plating C | Plating A | Plating B | Plating C | Plating A | Plating B | Plating C |
| With Solder Tails (See Notes 1 and 2.) | 2 | .084 [2.13] | — | 5-146261-1 | 5-146260-1 | 5-146258-1 | 5-146257-1 | 5-146256-1 | 5-146254-1 | 5-146253-1 | 5-146252-1 | 5-146250-1 |
| | 80 | 3.984 [101.19] | 3.900 [99.06] | 9-146261-0 | 9-146260-0 | 9-146258-0 | 9-146257-0 | 9-146256-0 | 9-146254-0 | 9-146253-0 | 9-146252-0 | 9-146250-0 |
| With Board Retention Tails (See Note 2.) | 2 | .084 [2.13] | — | 5-146273-1 | 5-146272-1 | 5-146270-1 | 5-146269-1 | 5-146268-1 | 5-146266-1 | 5-146265-1 | 5-146264-1 | 5-146262-1 |
| | 80 | 3.984 [101.19] | 3.900 [99.06] | 9-146273-0 | 9-146272-0 | 9-146270-0 | 9-146269-0 | 9-146268-0 | 9-146266-0 | 9-146265-0 | 9-146264-0 | 9-146262-0 |

Notes: 1. Headers without retention tails may be broken to the desired number of positions using **Tool Kit No. 314818-1 (not shown)**.
 2. Headers are also available in sizes 4 thru 78 positions. When ordering, add the prefix and/or suffix (dash) numbers plus 5-0 to the base part number that corresponds with the number of positions per row. For example, the complete part number for a 16-position header with solder tails (C dimension .090 [2.29], post plating A) would be 5-146261-8. The complete part number for a 40-position header with board retention tails (C dimension .120 [3.05], post plating B) would be 7-146268-0. This part numbering system applies only to this page.

Note: All part numbers are RoHS compliant.

Breakaway and Retention Headers-Unshrouded

5

Breakaway Headers—Unshrouded, Double-Row, .100 x .100 [2.54 x 2.54] Centerline (Continued)

.025 [0.64] Square Right-Angle Posts



Material and Finish

Housing — Black thermoplastic, 94V-0 rated, high temperature compatible

Posts — Phosphor bronze, duplex plated .000030 [0.00076] gold on contact area, .000100-.000200 [0.00254-0.00508] tin on solder tail, with entire post underplated .000050 [0.00127] nickel

Performance Characteristics (Board Retention Tails)

Insertion Force — 12 lb [53.4N] max.

Retention Force — .25 lb [1.11N] min.

Related Product Data

Mateable Connectors — Refer to the Mating Post Selection Guide — page 90

Technical Documents — page 276

See mating connector for applicable product and application specifications.

Headers with Solder Tails

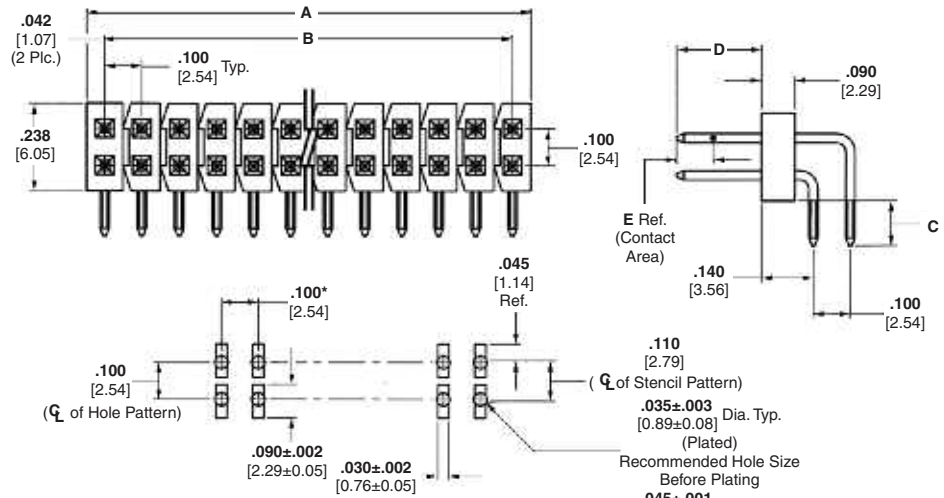

Recommended PC Board Mounting Pattern (for .062 [1.57] thick PC board; .008 [.203] thick stencil)

*±.003 [±0.08] tolerances not to accumulate within one connector pattern.

Headers with Board Retention Tails

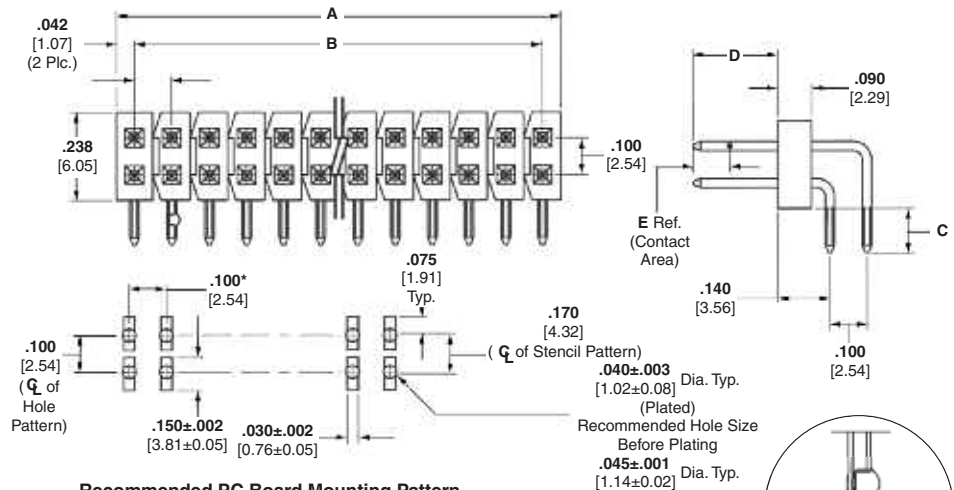

Recommended PC Board Mounting Pattern (for .062 [1.57] thick PC board; .008 [.203] thick stencil)

*±.003 [±0.08] tolerances not to accumulate within one connector pattern.

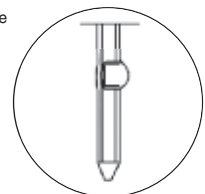

Board Retention using Swaged Tails (All Header Sizes)

| Header Style | No. of Pos. | Dimensions | | C = .120 [3.05] D = .230 [5.84] E = .185 [4.70] Part Nos. | | C = .110 [2.79] D = .318 [8.08] E = .200 [5.08] Part Nos. | |
|--|-------------|----------------|---------------|--|------------|--|--|
| | | A | B | | | | |
| With Solder Tails (See Notes 1 and 2.) | 2 | .084 [2.13] | — | 5-146308-1 | 5-146309-1 | | |
| | 80 | 3.984 [101.19] | 3.900 [99.06] | 9-146308-0 | 9-146309-0 | | |
| With Board Retention Tails (See Note 2.) | 2 | .084 [2.13] | — | 5-146310-1 | 5-146311-1 | | |
| | 80 | 3.984 [101.19] | 3.900 [99.06] | 9-146310-0 | 9-146311-0 | | |

Notes: 1. Headers without retention tails may be broken to the desired number of positions using **Tool Kit No. 314818-1 (not shown)**.
2. Headers are also available in sizes 4 thru 78 positions. When ordering, add the prefix and/or suffix (dash) numbers plus 5-0 to the base part number that corresponds with the number of positions per row. For example, the complete part number for a 16-position header with solder tails (C dimension .120 [3.05]) would be 5-146308-8. The complete part number for a 40-position header with board retention tails (C dimension .120 [3.05]) would be 7-146310-0. This part numbering system applies only to this page.

Note: All part numbers are RoHS compliant.

AMPMODU Reeled Breakaway Headers

Features of Breakaway Headers

- Design and inventory versatility — headers can easily be made into a variety of sizes
- High Temperature Compatible
- Reduced part number base
- Reduced inventory burden

Applications

- Desktops & workstations
- Set-top boxes
- Televisions
- Automotive instrument panels & radios
- Medical and test equipment

Benefits

- Off the shelf availability
- Various header length capability using the same reel
- Reduction of inventory costs
- Economy version of the standard breakaway headers

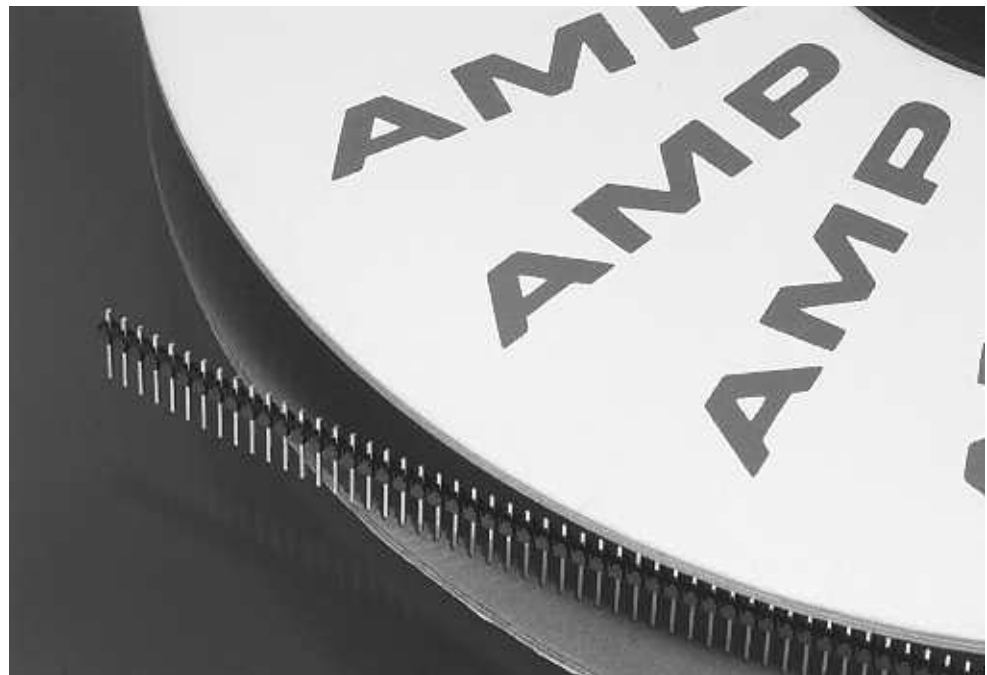

TE now offers AMPMODU reeled breakaway headers, which are used for board-to-board interconnections, on a continuous reel. The reeled breakaway headers are an economy version of the standard breakaway headers, and continue to provide the same high quality standards that TE is known for in the connector industry.

Reeled breakaway headers provide the flexibility to cut the headers to many different lengths, while only having to stock one part number. As a result, the amount of part numbers that need to be purchased and stored can be greatly reduced.

Reeled breakaway headers can be purchased in single and double rows with tin, 5 Au, 15 Au, and 30 Au duplex plating. The lower applied cost also offers .230" and .318" mating lengths. (See standard breakaway-to-reeled header conversion chart for vertical headers on the reverse side of this sheet)

Potential industries include: computer peripherals, telecommunications equipment, consumer, automotive, medical and test equipment.

Tooling available from:
Robo-Pak, Inc.
814 Lakeshore Drive
East Bethel, MN 55902

A pin retention and pin removal tooling option is also available in addition to cutting.

AMPMODU Reeled Breakaway Headers (Continued)

Single Row

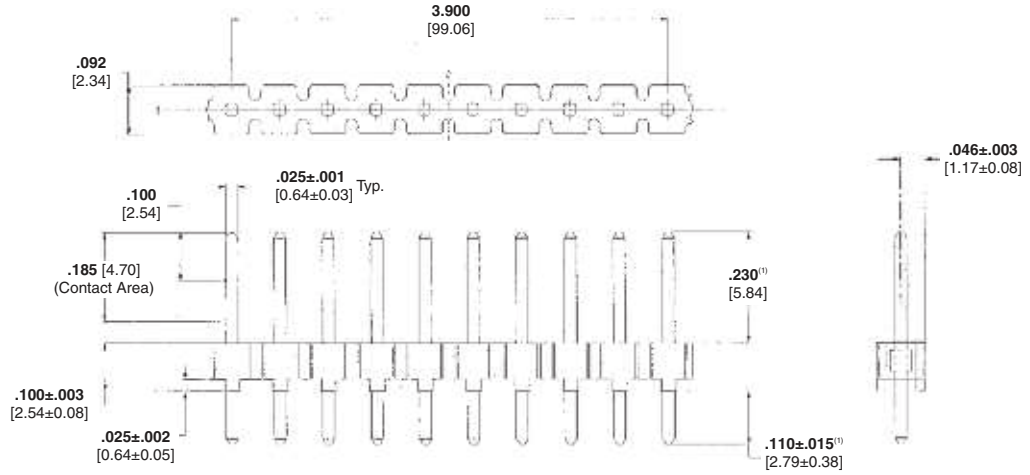

Double Row

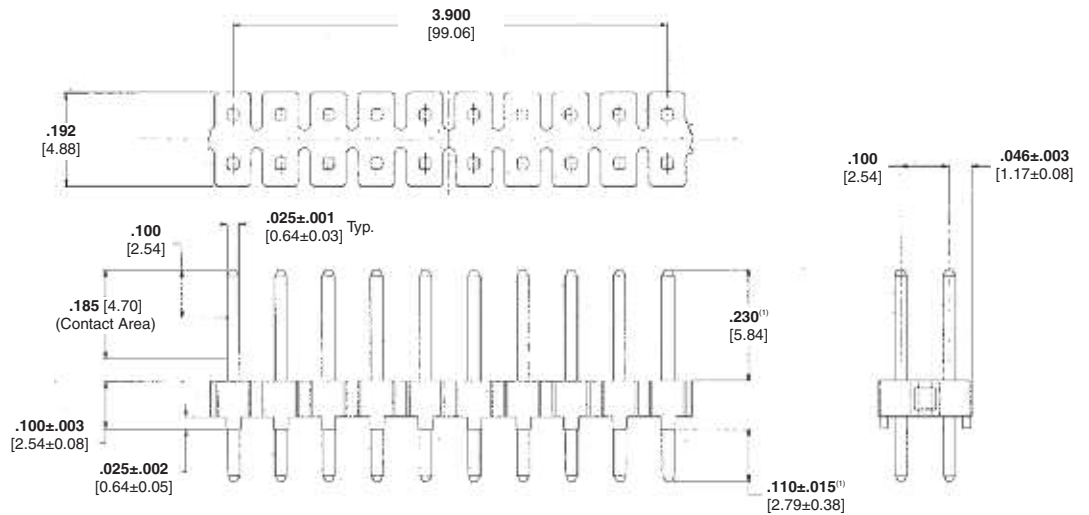

(1) See table for other mate and tail lengths.

| Standard Breakaway-to-Reeled Header Conversion Chart (Vertical) | | | | | | | | |
|---|--------------------------|--------------------------|--------------------------|--------------------------|--------------------------|--------------------------|--------------------------|--------------------------|
| Plating Options | Double Row Headers | | | | Single Row Headers | | | |
| | Existing TE P/N | Make From Reeled P/N | Existing TE P/N | Make From Reeled P/N | Existing TE P/N | Make From Reeled P/N | Existing TE P/N | Make From Reeled P/N |
| | Mate: .318 Tail: .125 | Mate: .318 Tail: .115 | Mate: .230 Tail: .120 | Mate: .230 Tail: .110 | Mate: .318 Tail: .125 | Mate: .318 Tail: .115 | Mate: .230 Tail: .120 | Mate: .230 Tail: .110 |
| Tin | 103322 | 5-146853-1 | 103328 | 5-146851-1 | 103321 | 5-146852-1 | 103327 | 5-146850-1 |
| | 146250 | | 146254 | | 146274 | | 146278 | |
| 15 Au Duplex | 102973 | 5-146861-1 | 103186 | 5-146859-1 | 102972 | 5-146860-1 | 103185 | 5-146858-1 |
| | 146252 | | 146256 | | 146276 | | 146280 | |
| 30 Au Duplex | 102977 | 5-146871-1 | 103240 | 5-146869-1 | 102976 | 5-146870-1 | 103239 | 5-146868-1 |
| | 146253 | | 146257 | | 146277 | | 146281 | |

Note: Reeled Headers are a functional substitute for standard breakaways, however there are visual differences (i.e. housing appearance and bow due to reeling requirement).

Note: All part numbers are RoHS compliant.

Breakaway Surface Mount Headers, .100 x .100 [2.54 x 2.54] Centerline

Product Facts

- Surface Mount Leads
- Contact Material: phosphor bronze
- High temperature, black thermoplastic housings, 94V-0 rated, capable of withstanding IR or vapor-phase reflow
- Recognized under the Component Program of Underwriters Laboratories Inc.  File No. E28476
- Certified by Canadian Standards Association,  File No. LR 7189
- Choice of gold duplex or tin plated posts
- Posts coplanar within .006 [0.15]
- Tape and reel packaging available in addition to single tube packaging. Contact TE.
- Pick-and-place cap available for vacuum placement. Contact TE.

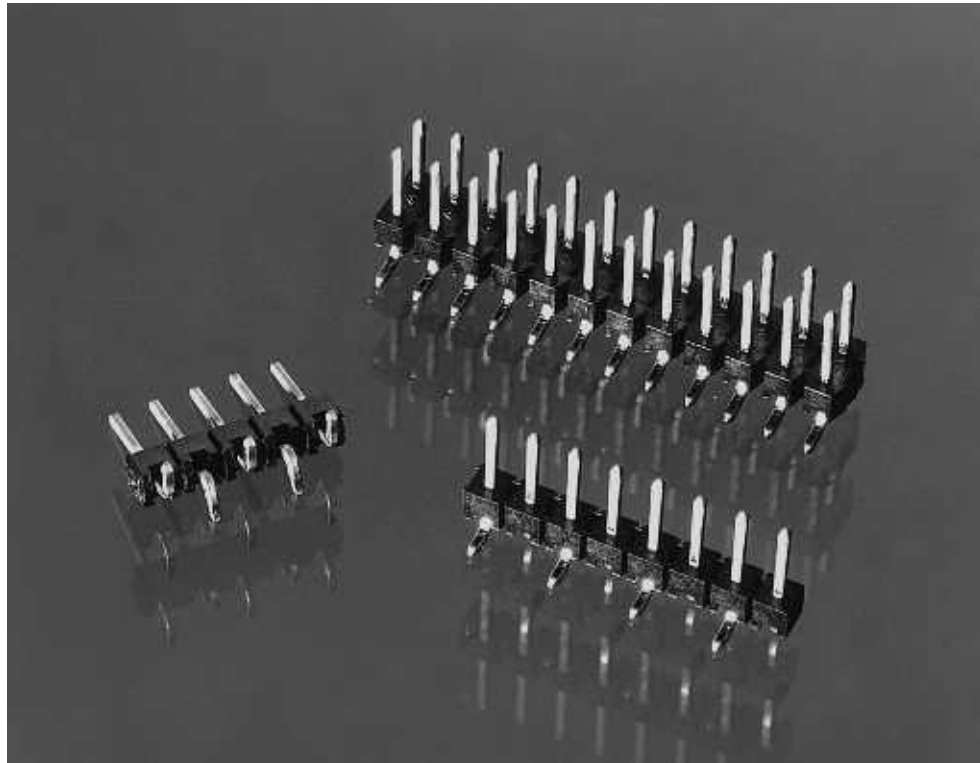

An extension of the AMPMODU Breakaway Header product family are the surface mount, vertical breakaway headers. The AMPMODU Surface Mount breakaway headers (Unshrouded) are available

in single- and double-row vertical configurations with mating lengths of .230 [5.84] and .320 [8.13]. Posts are offered with a choice of either .000030 [.0007] gold duplex or tin plating.

Current packaging is in a single tube but tape and reel is available for automatic pick-and-place. We also can provide a pick-and-place cap for vacuum placement if required.

Surface Mount Breakaway Headers

5

Breakaway Surface Mount Headers—Unshrouded Single-Row, .100 [2.54] Centerline

.025 [0.64] Square Straight Post



Material and Finish

Housing — Black thermoplastic, 94V-0 rated

Posts — Phosphor bronze, plated as follows:

Plating A — Duplex plated .000030 [0.00076] gold on contact area, .000100-.000200 [0.00254-0.00508] tin on solder area, with entire post underplated .000050 [0.00127] nickel

Plating B — .000100-.000200 [0.00254-0.00508] tin over .000050 [0.00127] nickel entire post

Related Product Data

Mateable Receptacle — Refer to Mating Post Selection Guide — page 90

Technical Documents — page 276

See mating connector for applicable product and application specifications.

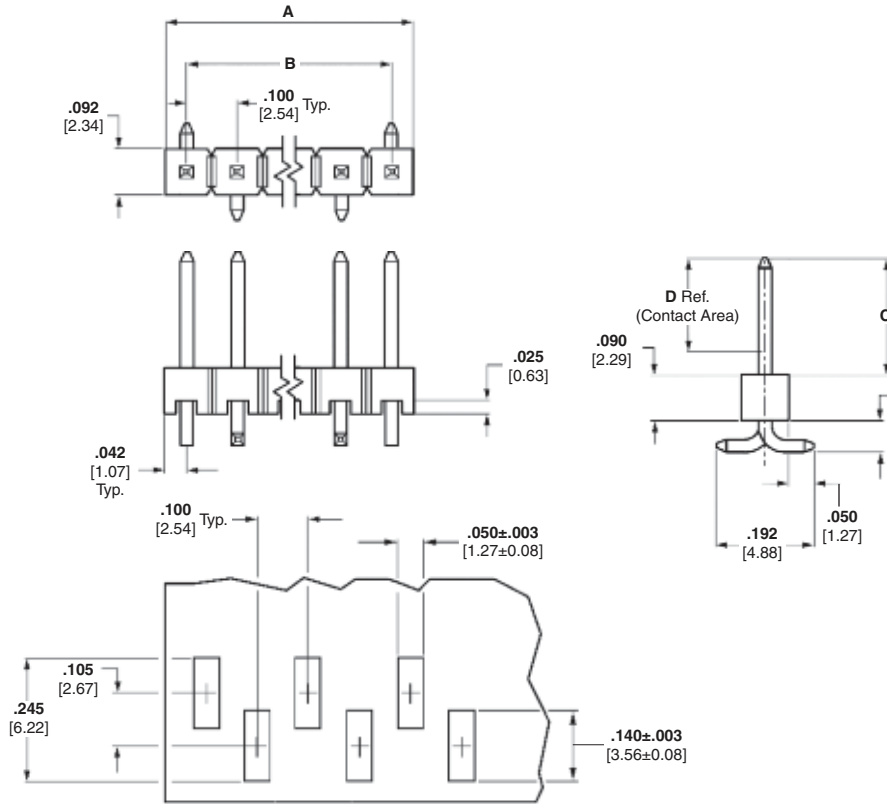

Recommended Etched Circuit Layout
(Using .008 [0.20] thick stencil)

Surface Mount Breakaway Headers

5

| No. of Pos. | Dimensions | | C = .230 [5.84] D = .185 [4.70] | | C = .320 [8.13] D = .200 [5.08] | |
|-------------|---------------|---------------|------------------------------------|------------|------------------------------------|------------|
| | A | B | Post Plating/Part Nos. | | Post Plating/Part Nos. | |
| | | | Plating A | Plating B | Plating A | Plating B |
| 3 | .284 [7.21] | .200 [5.08] | 5-146128-1 | 5-146132-1 | 5-146129-1 | 5-146133-1 |
| 4 | .384 [9.75] | .300 [7.62] | 5-146128-2 | 5-146132-2 | 5-146129-2 | 5-146133-2 |
| 5 | .484 [12.29] | .400 [10.16] | 5-146128-3 | 5-146132-3 | 5-146129-3 | 5-146133-3 |
| 6 | .584 [14.83] | .500 [12.70] | 5-146128-4 | 5-146132-4 | 5-146129-4 | 5-146133-4 |
| 7 | .684 [17.37] | .600 [15.24] | 5-146128-5 | 5-146132-5 | 5-146129-5 | 5-146133-5 |
| 8 | .784 [19.91] | .700 [17.78] | 5-146128-6 | 5-146132-6 | 5-146129-6 | 5-146133-6 |
| 9 | .884 [22.45] | .800 [20.32] | 5-146128-7 | 5-146132-7 | 5-146129-7 | 5-146133-7 |
| 10 | .984 [24.99] | .900 [22.86] | 5-146128-8 | 5-146132-8 | 5-146129-8 | 5-146133-8 |
| 11 | 1.084 [27.53] | 1.000 [25.40] | 5-146128-9 | 5-146132-9 | 5-146129-9 | 5-146133-9 |
| 12 | 1.184 [30.07] | 1.100 [27.94] | 6-146128-0 | 6-146132-0 | 6-146129-0 | 6-146133-0 |
| 13 | 1.284 [32.61] | 1.200 [30.48] | 6-146128-1 | 6-146132-1 | 6-146129-1 | 6-146133-1 |
| 14 | 1.384 [35.15] | 1.300 [33.02] | 6-146128-2 | 6-146132-2 | 6-146129-2 | 6-146133-2 |
| 15 | 1.484 [37.69] | 1.400 [35.56] | 6-146128-3 | 6-146132-3 | 6-146129-3 | 6-146133-3 |

Note: All part numbers are RoHS compliant.

Breakaway Surface Mount Headers—Unshrouded Double-Row, .100 x .100 [2.54 x 2.54] Centerline

.025 [0.64] Square Straight Post



Material and Finish

Housing — Black thermoplastic, 94V-0 rated

Posts — Phosphor bronze, plated as follows:

Plating A — Duplex plated .000030 [0.00076] gold on contact area, .000100-.000200 [0.00254-0.00508] tin on solder area, with entire post underplated .000050 [0.00127] nickel

Plating B — .000100-.000200 [0.00254-0.00508] tin over .000050 [0.00127] nickel entire post

Related Product Data

Mateable Receptacles — Refer to Mating Post Selection Guide — page 90

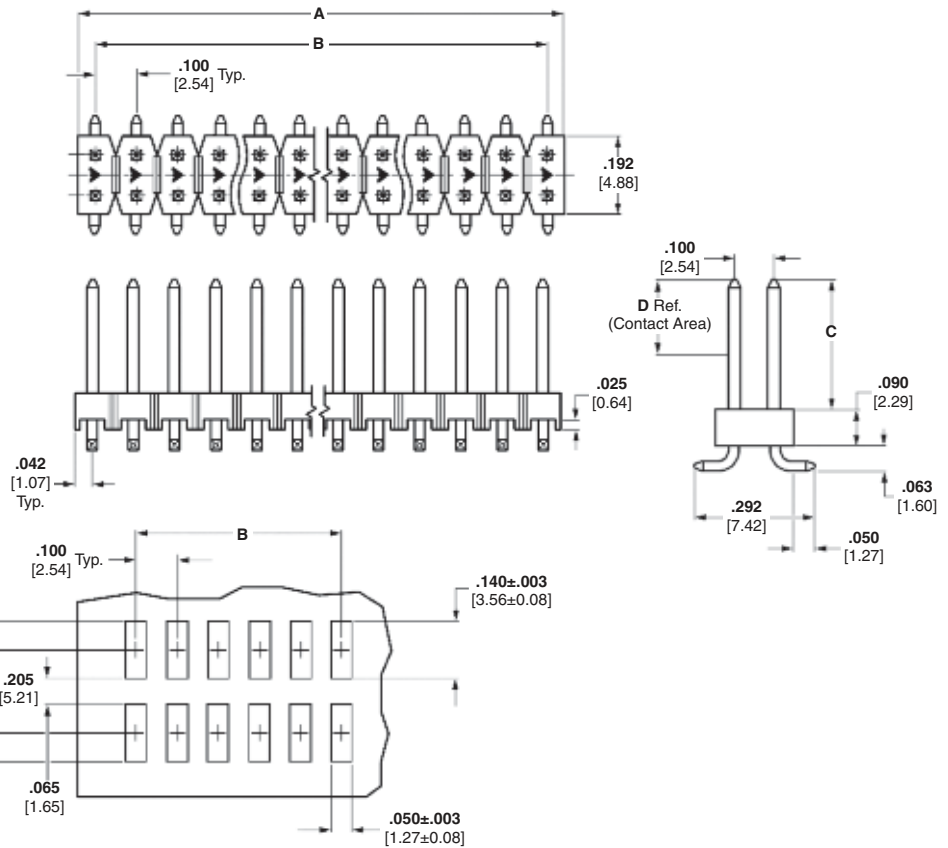

Recommended Etched Circuit Layout (Using .008 [0.20] thick stencil)

| No. of Pos. | Dimensions | | C = .230 [5.84] D = .185 [4.70] | | C = .320 [8.13] D = .200 [5.08] | |
|-------------|---------------|---------------|------------------------------------|------------|------------------------------------|------------|
| | A | B | Post Plating/Part Nos. | | Post Plating/Part Nos. | |
| | | | Plating A | Plating B | Plating A | Plating B |
| 4 | .184 [4.67] | .100 [2.54] | 5-146130-1 | 5-146134-1 | 5-146131-1 | 5-146135-1 |
| 6 | .284 [7.21] | .200 [5.08] | 5-146130-2 | 5-146134-2 | 5-146131-2 | 5-146135-6 |
| 8 | .384 [9.75] | .300 [7.62] | 5-146130-3 | 5-146134-3 | 5-146131-3 | 5-146135-3 |
| 10 | .484 [12.29] | .400 [10.16] | 5-146130-4 | 1-146134-7 | 5-146131-4 | 5-146135-4 |
| 12 | .584 [14.83] | .500 [12.70] | 5-146130-5 | 5-146134-5 | 5-146131-5 | 5-146135-5 |
| 14 | .684 [17.37] | .600 [15.24] | 5-146130-6 | 5-146134-6 | 5-146131-6 | 5-146135-6 |
| 16 | .784 [19.91] | .700 [17.78] | 5-146130-7 | 1-146134-9 | 5-146131-7 | 5-146135-7 |
| 18 | .884 [22.45] | .800 [20.32] | 5-146130-8 | 5-146134-8 | 5-146131-8 | 5-146135-8 |
| 20 | .984 [24.99] | .900 [22.86] | 5-146130-9 | 5-146134-9 | 5-146131-9 | 5-146135-9 |
| 22 | 1.084 [27.53] | 1.000 [25.40] | 6-146130-0 | 6-146134-0 | 6-146131-0 | 6-146135-0 |
| 24 | 1.184 [30.07] | 1.100 [27.94] | 6-146130-1 | 6-146134-1 | 6-146131-1 | 6-146135-1 |
| 26 | 1.284 [32.61] | 1.200 [30.48] | 6-146130-2 | 6-146134-2 | 6-146131-2 | 6-146135-2 |
| 28 | 1.384 [35.15] | 1.300 [33.02] | 6-146130-3 | 6-146134-3 | 6-146131-3 | 6-146135-3 |
| 30 | 1.484 [37.69] | 1.400 [35.56] | 6-146130-4 | 2-146134-1 | 6-146131-4 | 6-146135-4 |

Note: All part numbers are RoHS compliant.

Unshrouded Stacking Headers—Breakaway .100 x .100 [2.54 x 2.54] Centerline

Product Facts

- Available in single and double row
- Parallel PC board stacking with numerous stack heights available
- Drawn wire posts allow 4 side mateability
- May eliminate the need for additional board spacers
- Can be used in conjunction with bottom entry receptacles
- Gold or tin plated
- Up to 1.430 [36.32] overall post length
- Retention and surface mount features available upon request
- Other header sizes can be made upon request
- Tape and reel packaging available. Contact TE.
- Pick-and-place cap available for vacuum placement. Contact TE.

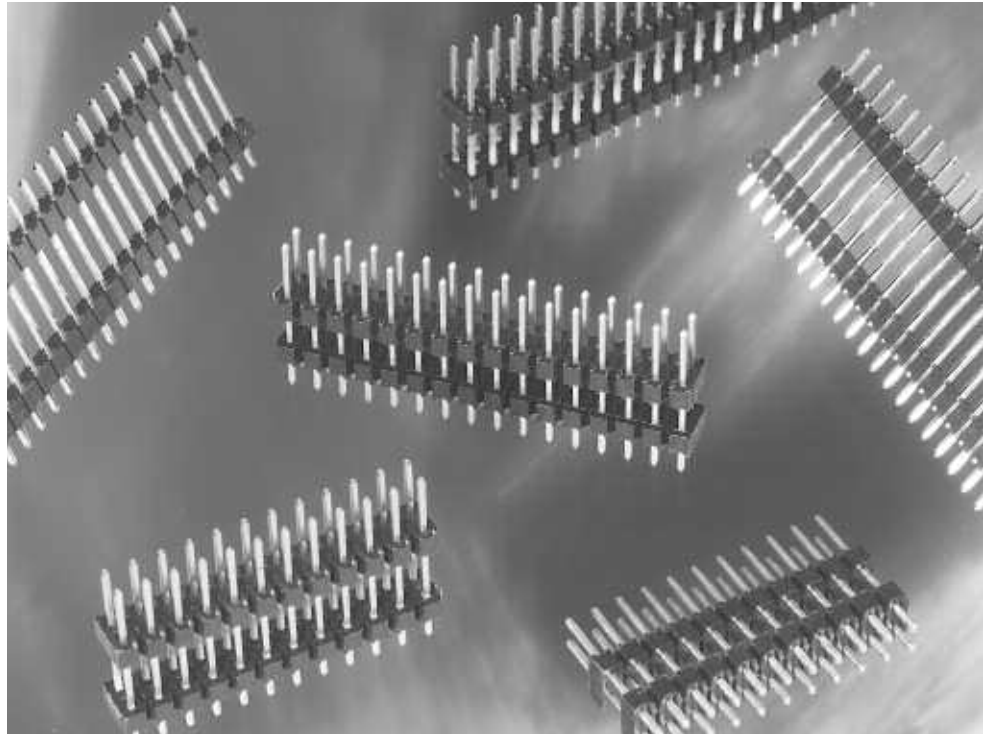

Unshrouded Stacking Headers — Breakaway, Single-Row, .100 [2.54] Centerline

.025 [0.64] Square Straight Posts

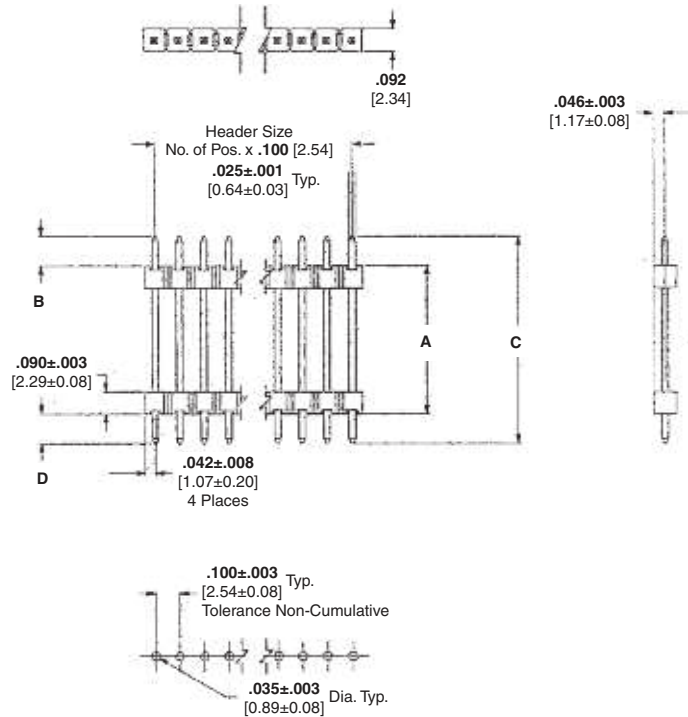

Recommended PC Board Hole Layout

Material and Finish

Housing — Black thermoplastic, 94V-0 rated

Posts — Phosphor bronze, plated as follows:

Plating — As noted in chart:

Tin — .000100-.000200 [0.00254-0.00508] tin over .000050 [0.00127] nickel entire post

15Au — .000015 [0.00038] gold over .000050 [0.00127] nickel entire post

Related Product Data

Mateable Receptacles — Refer to the Mating Post Selection Guide — page 88

Technical Documents — page 276

See mating connector for applicable product and application specifications.

Retention and surface mount features available upon request. Other header sizes can be made upon request.

***Note:** Headers are available in sizes 1 thru 40. When ordering, add the prefix and/or suffix (dash) numbers plus 5- -0 to the base part number that corresponds with the number of positions per row. For example, the complete part number for an 8-position header is 5-146455-8. The complete part number for a 16-position of the same series would be 6-146455-6.

| Base Number (see note) | A Stack Height | B Tail Length | C Post Length | D Mating Length | B End Plating | D End Plating |
|------------------------|----------------|---------------|---------------|-----------------|---------------|---------------|
| 146455 | .200 [5.08] | .130 [3.30] | .440 [11.17] | .110 [2.79] | TIN | TIN |
| 146456 | .250 [6.35] | .080 [2.03] | .440 [11.17] | .110 [2.79] | TIN | TIN |
| 146457 | .250 [6.35] | .114 [2.89] | .474 [12.03] | .110 [2.79] | TIN | TIN |
| 146458 | .300 [7.62] | .123 [3.12] | .533 [13.53] | .110 [2.79] | TIN | TIN |
| 146459 | .400 [10.16] | .107 [2.71] | .617 [15.67] | .110 [2.79] | TIN | TIN |
| 146460 | .450 [11.43] | .057 [1.45] | .617 [15.67] | .110 [2.79] | TIN | TIN |
| 146461 | .500 [12.70] | .129 [3.27] | .739 [18.77] | .110 [2.79] | TIN | TIN |
| 146462 | .300 [7.62] | .109 [2.77] | .739 [18.77] | .330 [8.38] | TIN | 15 AU |
| 146463 | .600 [15.24] | .107 [2.71] | .817 [20.75] | .110 [2.79] | TIN | TIN |
| 146464 | .400 [10.16] | .087 [2.20] | .817 [20.75] | .330 [8.38] | TIN | 15 AU |
| 146465 | .700 [17.78] | .120 [3.05] | .930 [23.62] | .110 [2.79] | TIN | TIN |
| 146466 | .500 [12.70] | .100 [2.54] | .930 [23.62] | .330 [8.38] | TIN | 15 AU |
| 146467 | .270 [6.86] | .330 [8.38] | .930 [23.62] | .330 [8.38] | 15 AU | 15 AU |
| 146468 | .800 [20.32] | .120 [3.05] | 1.030 [26.16] | .110 [2.79] | TIN | TIN |
| 146469 | .600 [15.24] | .100 [2.54] | 1.030 [26.16] | .330 [8.38] | TIN | 15 AU |
| 146470 | .370 [9.39] | .330 [8.38] | 1.030 [26.16] | .330 [8.38] | 15 AU | 15 AU |
| 146471 | .900 [22.86] | .120 [3.05] | 1.130 [28.70] | .110 [2.79] | TIN | TIN |
| 146472 | .700 [17.78] | .100 [2.54] | 1.130 [28.70] | .330 [8.38] | TIN | 15 AU |
| 146473 | .470 [11.39] | .330 [8.38] | 1.130 [28.70] | .330 [8.38] | 15 AU | 15 AU |
| 146474 | 1.000 [25.40] | .120 [3.05] | 1.230 [31.24] | .110 [2.79] | TIN | TIN |
| 146475 | .800 [20.32] | .100 [2.54] | 1.230 [31.24] | .330 [8.38] | TIN | 15 AU |
| 146476 | .570 [14.47] | .330 [8.38] | 1.230 [31.24] | .330 [8.38] | 15 AU | 15 AU |
| 146477 | 1.100 [27.94] | .120 [3.05] | 1.330 [33.78] | .110 [2.79] | TIN | TIN |
| 146478 | .900 [22.68] | .100 [2.54] | 1.330 [33.78] | .330 [8.38] | TIN | 15 AU |
| 146479 | .670 [17.01] | .330 [8.38] | 1.330 [33.78] | .330 [8.38] | 15 AU | 15 AU |
| 146480 | 1.200 [30.48] | .120 [3.05] | 1.430 [36.32] | .110 [2.79] | TIN | TIN |
| 146481 | 1.000 [25.40] | .100 [2.54] | 1.430 [36.32] | .330 [8.38] | TIN | 15 AU |
| 146482 | .770 [19.55] | .330 [8.38] | 1.430 [36.32] | .330 [8.38] | 15 AU | 15 AU |

Note: All part numbers are RoHS compliant.

Unshrouded Stacking Headers — Breakaway, Double-Row, .100 x .100 [2.54 x 2.54] Centerline

.025 [0.64] Square Straight Posts

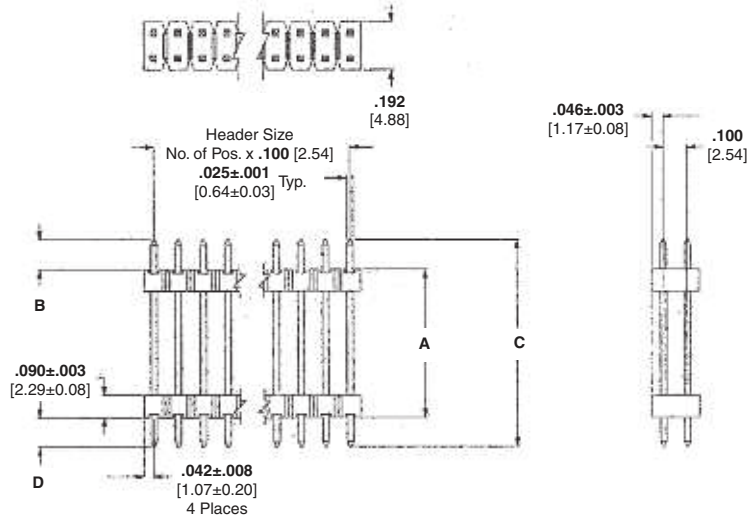

Material and Finish

Housing — Black thermoplastic, 94V-0 rated

Posts — Phosphor bronze, plated as follows:

Plating — As noted in chart:

Tin — .000100-.000200 [0.00254-0.00508] tin over .000050 [0.00127] nickel entire post

15Au — .000015 [0.00038] gold over .000050 [0.00127] nickel entire post

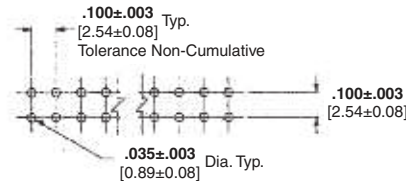

Related Product Data

Mateable Connectors — Refer to the Mating Post Selection Guide — page 90

Technical Documents — page 276

See mating connector for applicable product and application specifications.

Retention and surface mount features available upon request. Other header sizes can be made upon request.

Recommended PC Board Hole Layout

| Base Number (see note) | A Stack Height | B Tail Length | C Post Length | D Mating Length | B End Plating | D End Plating |
|------------------------|----------------|---------------|---------------|-----------------|---------------|---------------|
| 146483 | .200 [5.08] | .130 [3.30] | .440 [11.17] | .110 [2.79] | TIN | TIN |
| 146484 | .250 [6.35] | .080 [2.03] | .440 [11.17] | .110 [2.79] | TIN | TIN |
| 146485 | .250 [6.35] | .114 [2.89] | .474 [12.03] | .110 [2.79] | TIN | TIN |
| 146486 | .300 [7.62] | .123 [3.12] | .533 [13.53] | .110 [2.79] | TIN | TIN |
| 146487 | .400 [10.16] | .107 [2.71] | .617 [15.67] | .110 [2.79] | TIN | TIN |
| 146488 | .450 [11.43] | .057 [1.45] | .617 [15.67] | .110 [2.79] | TIN | TIN |
| 146489 | .500 [12.70] | .129 [3.27] | .739 [18.77] | .110 [2.79] | TIN | TIN |
| 146490 | .300 [7.62] | .109 [2.77] | .739 [18.77] | .330 [8.38] | TIN | 15 AU |
| 146491 | .600 [15.24] | .107 [2.71] | .817 [20.75] | .110 [2.79] | TIN | TIN |
| 146492 | .400 [10.16] | .087 [2.20] | .817 [20.75] | .330 [8.38] | TIN | 15 AU |
| 146493 | .700 [17.78] | .120 [3.05] | .930 [23.62] | .110 [2.79] | TIN | TIN |
| 146494 | .500 [12.70] | .100 [2.54] | .930 [23.62] | .330 [8.38] | TIN | 15 AU |
| 146495 | .270 [6.86] | .330 [8.38] | .930 [23.62] | .330 [8.38] | 15 AU | 15 AU |
| 146496 | .800 [20.32] | .120 [3.05] | 1.030 [26.16] | .110 [2.79] | TIN | TIN |
| 146497 | .600 [15.24] | .100 [2.54] | 1.030 [26.16] | .330 [8.38] | TIN | 15 AU |
| 146498 | .370 [9.39] | .330 [8.38] | 1.030 [26.16] | .330 [8.38] | 15 AU | 15 AU |
| 146499 | .900 [22.86] | .120 [3.05] | 1.130 [28.70] | .110 [2.79] | TIN | TIN |
| 146500 | .700 [17.78] | .100 [2.54] | 1.130 [28.70] | .330 [8.38] | TIN | 15 AU |
| 146501 | .470 [11.93] | .330 [8.38] | 1.130 [28.70] | .330 [8.38] | 15 AU | 15 AU |
| 146502 | 1.000 [25.40] | .120 [3.05] | 1.230 [31.24] | .110 [2.79] | TIN | TIN |
| 146503 | .800 [20.32] | .100 [2.54] | 1.230 [31.24] | .330 [8.38] | TIN | 15 AU |
| 146504 | .570 [14.74] | .330 [8.38] | 1.230 [31.24] | .330 [8.38] | 15 AU | 15 AU |
| 146505 | 1.100 [27.94] | .120 [3.05] | 1.330 [33.78] | .110 [2.79] | TIN | TIN |
| 146506 | .900 [22.86] | .100 [2.54] | 1.330 [33.78] | .330 [8.38] | TIN | 15 AU |
| 146507 | .670 [17.01] | .330 [8.38] | 1.330 [33.78] | .330 [8.38] | 15 AU | 15 AU |
| 146508 | 1.200 [30.48] | .120 [3.05] | 1.430 [36.32] | .110 [2.79] | TIN | TIN |
| 146509 | 1.000 [25.40] | .100 [2.54] | 1.430 [36.32] | .330 [8.38] | TIN | 15 AU |
| 146510 | .770 [19.55] | .330 [8.38] | 1.430 [36.32] | .330 [8.38] | 15 AU | 15 AU |

***Note:** Headers are available in sizes 2 thru 80. When ordering, add the prefix and/or suffix (dash) numbers plus 5- -0 to the base part number that corresponds with the number of positions per row. For example, the complete part number for a 16-position header is 5-146283-8. The complete part number for a 32-position of the same series would be 6-146283-6.

Note: All part numbers are RoHS compliant.

Standard Profile Headers—Shrouded

Product Facts

- Available in several styles—right-angle with three- and four-sided pin protection, and straight post with pin protection and mounting ears
- Post retention feature available
- Can be used for feed-to and feed-thru applications
- Housings are black thermoplastic, flame retardant 94V-0 rated
- Contacts are copper alloy
- Available in gold duplex, gold over nickel and tin over nickel platings
- Headers with .066 [1.68] and .150 [3.81] end dimensions are available in select sizes up to 60 positions
- Can be select loaded, consult TE
- Recognized under the Component Program of Underwriters Laboratories Inc. File No. E28476
- Certified by Canadian Standards Association, File No. LR 7189

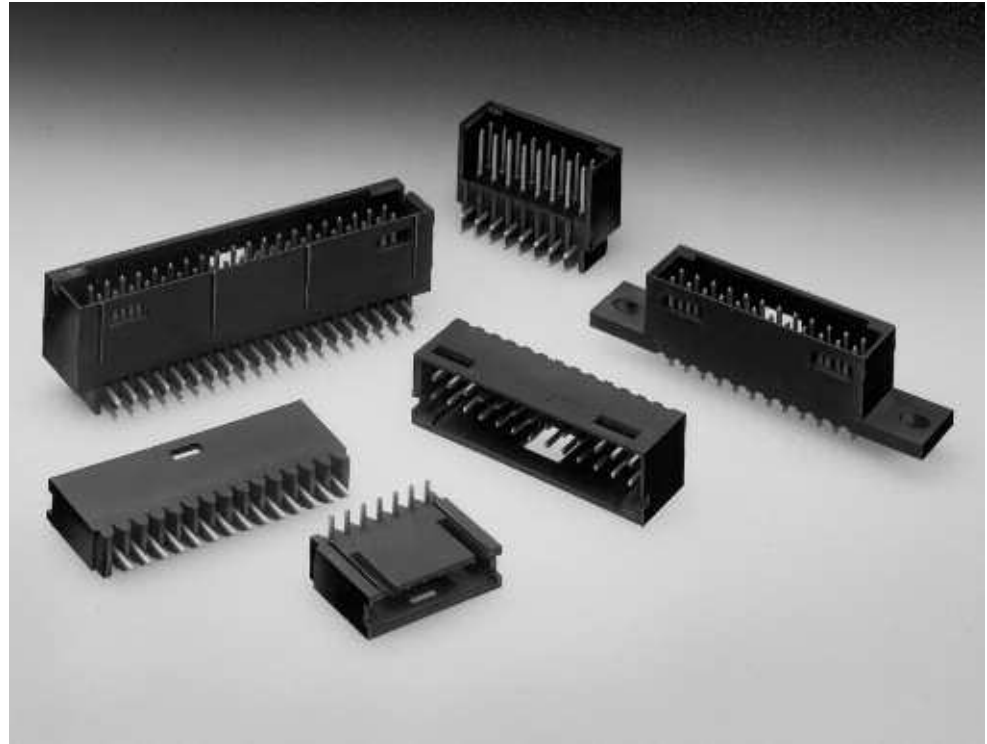

Performance Characteristics

Electrical

Insulation Resistance — 5,000 megohms minimum initial

Dielectric Withstanding Voltage — 750 RMS at sea level

Environmental

Operating Temperature — -65°C to +105°C (black thermoplastic housings)

Current — 3 amperes maximum per contact

Standard Profile Headers—Shrouded, Single-Row, .100 [2.54] Centerline

.025 [0.64] Square Straight Post (with Standoffs)



Material and Finish

Housing — Black thermoplastic, 94V-0 rated

Posts — Phosphor bronze, plated as follows:

Plating A — Duplex plated .000030 [0.00076] gold on contact area, .000100-.000200 [0.00254-0.00508] tin on solder area, with entire post under-plated .000050 [0.00127] nickel

Plating B — Duplex plated .000015 [0.00038] gold on contact area, .000100-.000200 [0.00254-0.00508] tin on solder area, with entire post under-plated .000050 [0.00127] nickel

Plating C — .000100-.000200 [0.00254-0.00508] tin over .000050 [0.00127] nickel on entire post

Related Product Data

Mateable Connectors —

AMPMODU Wire-Applied

Receptacles — page 215

AMPMODU MTE Receptacles — pages 228, 229, 234

Technical Documents — page 276

See mating connector for applicable product and application specifications.

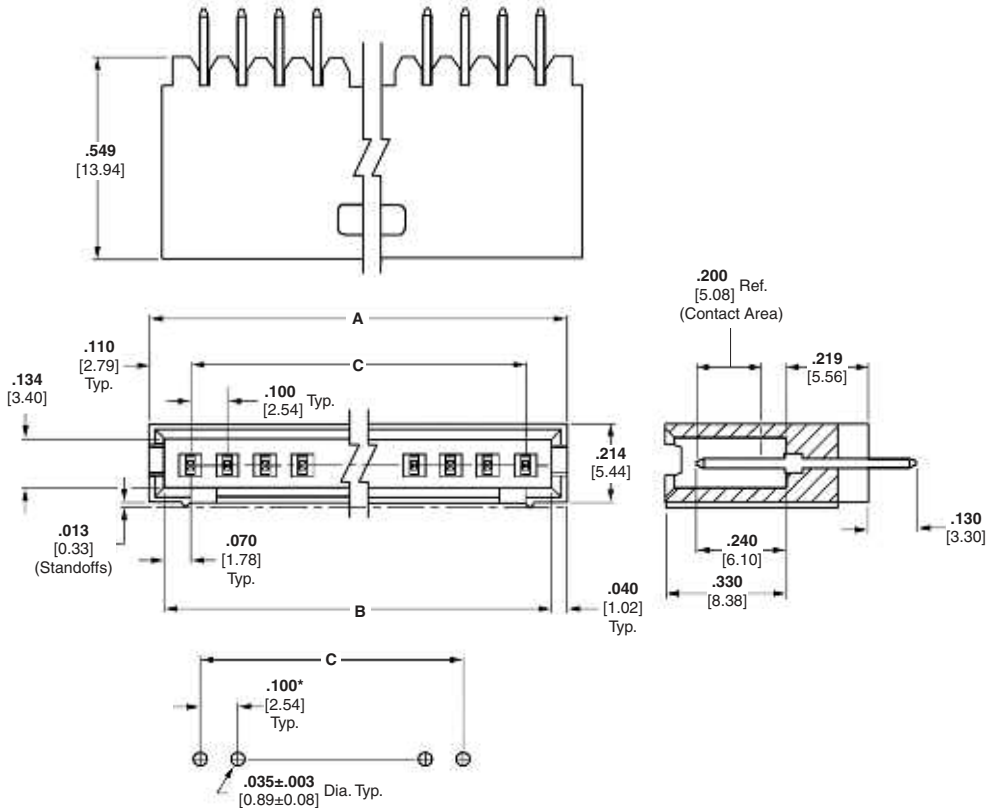

Recommended PC Board Hole Layout (for .055 [1.40] min. thick PC board)

*±.003 [±0.08] tolerances not to accumulate within one connector pattern.

| No. of Pos. | Dimensions | | | Post Plating/Part Nos. | | |
|-------------|---------------|---------------|---------------|------------------------|------------|------------|
| | A | B | C | Plating A | Plating B | Plating C |
| 3 | .420 [10.67] | .340 [8.64] | .200 [5.08] | 5-103414-1 | 8-102202-4 | 5-103080-1 |
| 4 | .520 [13.21] | .440 [11.18] | .300 [7.62] | 5-103414-2 | 5-102202-1 | 5-103080-2 |
| 5 | .620 [15.75] | .540 [13.72] | .400 [10.16] | 5-103414-3 | 5-102202-2 | 5-103080-3 |
| 6 | .720 [18.29] | .640 [16.26] | .500 [12.70] | 5-103414-4 | 5-102202-3 | 5-103080-4 |
| 7 | .820 [20.83] | .740 [18.80] | .600 [15.24] | 5-103414-5 | 5-102202-4 | 5-103080-5 |
| 8 | .920 [23.37] | .840 [21.34] | .700 [17.78] | 5-103414-6 | 5-102202-5 | 5-103080-6 |
| 9 | 1.020 [25.91] | .940 [23.88] | .800 [20.32] | 5-103414-7 | 5-102202-6 | 5-103080-7 |
| 10 | 1.120 [28.45] | 1.040 [26.42] | .900 [22.86] | 5-103414-8 | 5-102202-7 | 5-103080-8 |
| 11 | 1.220 [30.99] | 1.140 [28.96] | 1.000 [25.40] | 5-103414-9 | 5-102202-8 | 5-103080-9 |
| 12 | 1.320 [33.53] | 1.240 [31.50] | 1.100 [27.94] | 6-103414-0 | 5-102202-9 | 6-103080-0 |
| 13 | 1.420 [36.07] | 1.340 [34.04] | 1.200 [30.48] | 6-103414-1 | 6-102202-0 | 6-103080-1 |
| 14 | 1.520 [38.61] | 1.440 [36.58] | 1.300 [33.02] | 6-103414-2 | 6-102202-1 | 6-103080-2 |
| 15 | 1.620 [41.15] | 1.540 [39.12] | 1.400 [35.56] | 6-103414-3 | 6-102202-2 | 6-103080-3 |
| 16 | 1.720 [43.69] | 1.640 [41.66] | 1.500 [38.10] | 6-103414-4 | 6-102202-3 | 6-103080-4 |
| 17 | 1.820 [46.23] | 1.740 [44.20] | 1.600 [40.64] | 6-103414-5 | 6-102202-4 | 6-103080-5 |
| 18 | 1.920 [48.77] | 1.840 [46.74] | 1.700 [43.18] | 6-103414-6 | 6-102202-5 | 6-103080-6 |
| 19 | 2.020 [51.31] | 1.940 [49.28] | 1.800 [45.72] | 6-103414-7 | 6-102202-6 | 6-103080-7 |
| 20 | 2.120 [53.85] | 2.040 [51.82] | 1.900 [48.26] | 6-103414-8 | 6-102202-7 | 6-103080-8 |
| 21 | 2.220 [56.39] | 2.140 [54.36] | 2.000 [50.80] | 6-103414-9 | 6-102202-8 | 6-103080-9 |
| 22 | 2.320 [58.93] | 2.240 [56.90] | 2.100 [53.34] | 7-103414-0 | 6-102202-9 | 7-103080-0 |
| 23 | 2.420 [61.47] | 2.340 [59.44] | 2.200 [55.88] | 7-103414-1 | 7-102202-0 | 7-103080-1 |
| 24 | 2.520 [64.01] | 2.440 [61.98] | 2.300 [58.42] | 7-103414-2 | 7-102202-1 | 7-103080-2 |
| 25 | 2.620 [66.55] | 2.540 [64.52] | 2.400 [60.96] | 7-103414-3 | 7-102202-2 | 7-103080-3 |

Note: All part numbers are RoHS compliant.

Standard Profile Headers—Shrouded, Single-Row, .100 [2.54] Centerline (Continued)

.025 [0.64] Square Right-Angle Post (with Standoffs)

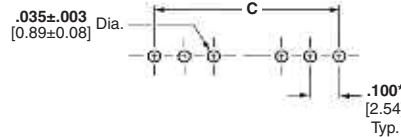
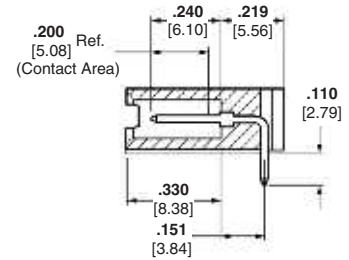
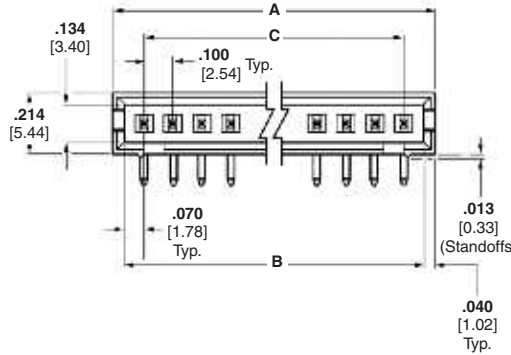
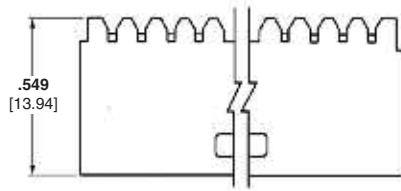

Recommended PC Board Hole Layout (for .055 [1.40] min. thick PC board)

*±.003 [±0.08] tolerances not to accumulate within one connector pattern.

Material and Finish

Housing — Black thermoplastic, 94V-0 rated

Posts — Phosphor bronze, plated as follows:

Plating A — Duplex plated .000030 [0.00076] gold on contact area, .000100-.000200 [0.00254-0.00508] tin on solder area, with entire post underplated .000050 [0.00127] nickel

Plating B — Duplex plated .000015 [0.00038] gold on contact area, .000100-.000200 [0.00254-0.00508] tin on solder area, with entire post underplated .000050 [0.00127] nickel

Plating C — .000100-.000200 [0.00254-0.00508] tin over .000050 [0.00127] nickel on entire post

Related Product Data

Mateable Connectors — AMPMODU Wire-Applied Receptacles — page 215

AMPMODU MTE Receptacles — pages 228, 229, 234

Technical Documents — page 276

See mating connector for applicable product and application specifications.

| No. of Pos. | Dimensions | | | Post Plating/Part Nos. | | |
|-------------|---------------|---------------|---------------|------------------------|------------|------------|
| | A | B | C | Plating A | Plating B | Plating C |
| 3 | .420 [10.67] | .340 [8.64] | .200 [5.08] | 5-103361-1 | 8-102203-4 | 5-102523-1 |
| 4 | .520 [13.21] | .440 [11.18] | .300 [7.62] | 5-103361-2 | 5-102203-1 | 5-102523-2 |
| 5 | .620 [15.75] | .540 [13.72] | .400 [10.16] | 5-103361-3 | 5-102203-2 | 5-102523-3 |
| 6 | .720 [18.29] | .640 [16.26] | .500 [12.70] | 5-103361-4 | 5-102203-3 | 5-102523-4 |
| 7 | .820 [20.83] | .740 [18.80] | .600 [15.24] | 5-103361-5 | 5-102203-4 | 5-102523-5 |
| 8 | .920 [23.37] | .840 [21.34] | .700 [17.78] | 5-103361-6 | 5-102203-5 | 5-102523-6 |
| 9 | 1.020 [25.91] | .940 [23.88] | .800 [20.32] | 5-103361-7 | 5-102203-6 | 5-102523-7 |
| 10 | 1.120 [28.45] | 1.040 [26.42] | .900 [22.86] | 5-103361-8 | 5-102203-7 | 5-102523-8 |
| 11 | 1.220 [30.99] | 1.140 [28.96] | 1.000 [25.40] | 5-103361-9 | 5-102203-8 | 5-102523-9 |
| 12 | 1.320 [33.53] | 1.240 [31.50] | 1.100 [27.94] | 6-103361-0 | 5-102203-9 | 6-102523-0 |
| 13 | 1.420 [36.07] | 1.340 [34.04] | 1.200 [30.48] | 6-103361-1 | 6-102203-0 | 6-102523-1 |
| 14 | 1.520 [38.61] | 1.440 [36.58] | 1.300 [33.02] | 6-103361-2 | 6-102203-1 | 6-102523-2 |
| 15 | 1.620 [41.15] | 1.540 [39.12] | 1.400 [35.56] | 6-103361-3 | 6-102203-2 | 6-102523-3 |
| 16 | 1.720 [43.69] | 1.640 [41.66] | 1.500 [38.10] | 6-103361-4 | 6-102203-3 | 6-102523-4 |
| 17 | 1.820 [46.23] | 1.740 [44.20] | 1.600 [40.64] | 6-103361-5 | 6-102203-4 | 6-102523-5 |
| 18 | 1.920 [48.77] | 1.840 [46.74] | 1.700 [43.18] | 6-103361-6 | 6-102203-5 | 6-102523-6 |
| 19 | 2.020 [51.31] | 1.940 [49.28] | 1.800 [45.72] | 6-103361-7 | 6-102203-6 | 6-102523-7 |
| 20 | 2.120 [53.85] | 2.040 [51.82] | 1.900 [48.26] | 6-103361-8 | 6-102203-7 | 6-102523-8 |
| 21 | 2.220 [56.39] | 2.140 [54.36] | 2.000 [50.80] | 6-103361-9 | 6-102203-8 | 6-102523-9 |
| 22 | 2.320 [58.93] | 2.240 [56.90] | 2.100 [53.34] | 7-103361-0 | 6-102203-9 | 7-102523-0 |
| 23 | 2.420 [61.47] | 2.340 [59.44] | 2.200 [55.88] | 7-103361-1 | 7-102203-0 | 7-102523-1 |
| 24 | 2.520 [64.01] | 2.440 [61.98] | 2.300 [58.42] | 7-103361-2 | 7-102203-1 | 7-102523-2 |
| 25 | 2.620 [66.55] | 2.540 [64.52] | 2.400 [60.96] | 7-103361-3 | 7-102203-2 | 7-102523-3 |

Note: All part numbers are RoHS compliant.

Standard Profile Headers—Shrouded, with .066 [1.68] End Dimension, Double-Row, .100 x .100 [2.54 x 2.54] Centerline

.025 [0.64] Square Straight Post (with Detent Windows)

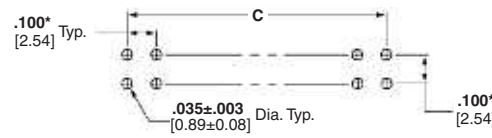
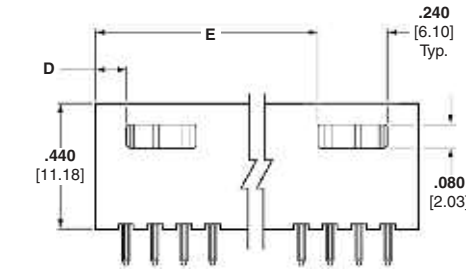
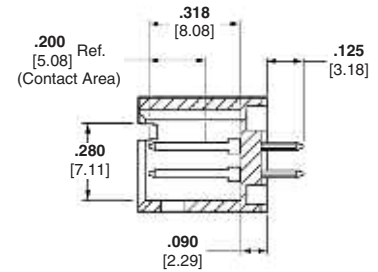
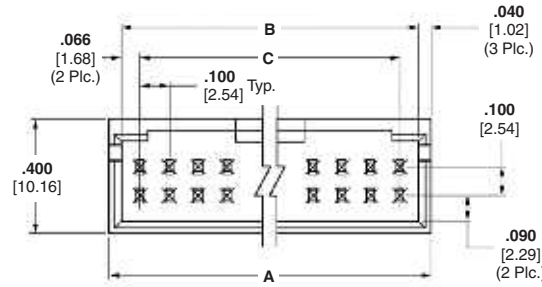

Recommended PC Board Hole Layout
(for .055 [1.40] min. thick PC board)

*±.003 [±0.08] tolerances not to accumulate within one connector pattern.

Material and Finish

- Housing** — Black thermoplastic, 94V-0 rated
- Posts** — Phosphor bronze, plated as follows:
 - Plating A** — Duplex plated .000030 [0.00076] gold on contact area, .000100-.000200 [0.00254-0.00508] tin on solder area, with entire post underplated .000050 [0.00127] nickel
 - Plating B** — Duplex plated .000015 [0.00038] gold on contact area, .000100-.000200 [0.00254-0.00508] tin on solder area, with entire post underplated .000050 [0.00127] nickel
 - Plating C** — .000100-.000200 [0.00254-0.00508] tin over .000050 [0.00127] nickel on entire post

Related Product Data

- Mateable Connectors** —
- AMPMODU Board Mount Receptacles** — pages 176, 179, 180
- AMPMODU Wire-Applied Receptacles** — pages 216-219
- AMPMODU MTE Receptacles** — pages 228, 229, 234
- AMPMODU MT Receptacles** — pages 256, 257

Accessories

Barrier Insert — page 204

Technical Documents

See mating connector for applicable product and application specifications.

| No. of Pos. | Dimensions | | | | | Post Plating/Part Nos. | | |
|-------------|---------------|---------------|---------------|--------------|---------------|------------------------|------------|-----------|
| | A | B | C | D | E | Plating A | Plating B | Plating C |
| 6 | .412 [10.46] | .332 [8.43] | .200 [5.08] | .106 [2.69] | — | 5-103168-1 | 5-102618-1 | 8-87589-6 |
| 8 | .512 [13.00] | .432 [10.97] | .300 [7.62] | .106 [2.69] | — | 5-103168-2 | 5-102618-2 | 8-87589-5 |
| 10 | .612 [15.54] | .532 [13.51] | .400 [10.16] | .206 [5.23] | — | 5-103168-3 | 5-102618-3 | 5-87589-1 |
| 12 | .712 [18.08] | .632 [16.05] | .500 [12.70] | .206 [5.23] | — | 5-103168-4 | 5-102618-4 | 5-87589-2 |
| 14 | .812 [20.62] | .732 [18.59] | .600 [15.24] | .306 [7.77] | — | 5-103168-5 | 5-102618-5 | 5-87589-3 |
| 16 | .912 [23.16] | .832 [21.13] | .700 [17.78] | .306 [7.77] | — | 5-103168-6 | 5-102618-6 | 5-87589-4 |
| 18 | 1.012 [25.70] | .932 [23.67] | .800 [20.32] | .406 [10.31] | — | 5-103168-7 | 5-102618-7 | 5-87589-5 |
| 20 | 1.112 [28.24] | 1.032 [26.21] | .900 [22.86] | .106 [2.69] | .806 [20.47] | 5-103168-8 | 5-102618-8 | 5-87589-6 |
| 22 | 1.212 [30.78] | 1.132 [28.75] | 1.000 [25.40] | .106 [2.69] | .906 [23.01] | 5-103168-9 | 5-102618-9 | 5-87589-7 |
| 24 | 1.312 [33.32] | 1.232 [31.29] | 1.100 [27.94] | .106 [2.69] | 1.006 [25.55] | 6-103168-0 | 6-102618-0 | 5-87589-8 |
| 26 | 1.412 [35.86] | 1.332 [33.83] | 1.200 [30.48] | .106 [2.69] | 1.106 [28.09] | 6-103168-1 | 6-102618-1 | 5-87589-9 |
| 28 | 1.512 [38.40] | 1.432 [36.37] | 1.300 [33.02] | .106 [2.69] | 1.206 [30.63] | 6-103168-2 | 6-102618-2 | 6-87589-0 |
| 30 | 1.612 [40.94] | 1.532 [38.91] | 1.400 [35.56] | .106 [2.69] | 1.306 [33.17] | 6-103168-3 | 6-102618-3 | 6-87589-1 |

Note: All part numbers are RoHS compliant.

**Standard Profile Headers—Shrouded, with .066 [1.68]
End Dimension, Double-Row, .100 x .100 [2.54 x 2.54] Centerline** (Continued)

| No. of Positions | Dimensions | | | | | Post Plating/Part Nos. | | |
|------------------|---------------|---------------|---------------|-------------|---------------|------------------------|------------|-----------|
| | A | B | C | D | E | Plating A | Plating B | Plating C |
| 32 | 1.712 [43.48] | 1.632 [41.45] | 1.500 [38.10] | .106 [2.69] | 1.406 [35.71] | 6-103168-4 | 6-102618-4 | 6-87589-2 |
| 34 | 1.812 [46.02] | 1.732 [43.99] | 1.600 [40.64] | .106 [2.69] | 1.506 [38.25] | 6-103168-5 | 6-102618-5 | 6-87589-3 |
| 36 | 1.912 [48.56] | 1.832 [46.53] | 1.700 [43.18] | .106 [2.69] | 1.606 [40.79] | 6-103168-6 | 6-102618-6 | 6-87589-4 |
| 38 | 2.012 [51.10] | 1.932 [49.07] | 1.800 [45.72] | .106 [2.69] | 1.706 [43.33] | 6-103168-7 | 6-102618-7 | 6-87589-5 |
| 40 | 2.112 [53.64] | 2.032 [51.61] | 1.900 [48.26] | .106 [2.69] | 1.806 [45.87] | 6-103168-8 | 6-102618-8 | 6-87589-6 |
| 42 | 2.212 [56.18] | 2.132 [54.15] | 2.000 [50.80] | .106 [2.69] | 1.906 [48.41] | 6-103168-9 | 6-102618-9 | 6-87589-7 |
| 44 | 2.312 [58.72] | 2.232 [56.69] | 2.100 [53.34] | .106 [2.69] | 2.006 [50.95] | 7-103168-0 | 7-102618-0 | 6-87589-8 |
| 46 | 2.412 [61.26] | 2.332 [59.23] | 2.200 [55.88] | .106 [2.69] | 2.106 [53.49] | 7-103168-1 | 7-102618-1 | 6-87589-9 |
| 48 | 2.512 [63.80] | 2.432 [61.77] | 2.300 [58.42] | .106 [2.69] | 2.206 [56.03] | 7-103168-2 | 7-102618-2 | 7-87589-0 |
| 50 | 2.612 [66.34] | 2.532 [64.31] | 2.400 [60.96] | .106 [2.69] | 2.306 [58.57] | 7-103168-3 | 7-102618-3 | 7-87589-1 |
| 52 | 2.712 [68.88] | 2.632 [66.85] | 2.500 [63.50] | .106 [2.69] | 2.406 [61.11] | 7-103168-4 | 7-102618-4 | 7-87589-2 |
| 54 | 2.812 [71.42] | 2.732 [69.39] | 2.600 [66.04] | .106 [2.69] | 2.506 [63.65] | 7-103168-5 | 7-102618-5 | 7-87589-3 |
| 56 | 2.912 [73.96] | 2.832 [71.93] | 2.700 [68.58] | .106 [2.69] | 2.606 [66.19] | 7-103168-6 | 7-102618-6 | 7-87589-4 |
| 58 | 3.012 [76.50] | 2.932 [74.47] | 2.800 [71.12] | .106 [2.69] | 2.706 [68.73] | 7-103168-7 | 7-102618-7 | 7-87589-5 |
| 60 | 3.112 [79.04] | 3.032 [77.01] | 2.900 [73.66] | .106 [2.69] | 2.806 [71.27] | 7-103168-8 | 7-102618-8 | 7-87589-6 |
| 62 | 3.212 [81.58] | 3.132 [79.55] | 3.000 [76.20] | .106 [2.69] | 2.906 [73.81] | 7-103168-9 | 7-102618-9 | 7-87589-7 |
| 64 | 3.312 [84.12] | 3.232 [82.09] | 3.100 [78.74] | .106 [2.69] | 3.006 [76.35] | 8-103168-0 | 8-102618-0 | 7-87589-8 |
| 66 | 3.412 [86.66] | 3.332 [84.63] | 3.200 [81.28] | .106 [2.69] | 3.106 [78.89] | 8-103168-1 | 8-102618-1 | 7-87589-9 |
| 68 | 3.512 [89.20] | 3.432 [87.17] | 3.300 [83.82] | .106 [2.69] | 3.206 [81.43] | 8-103168-2 | 8-102618-2 | 8-87589-0 |
| 70 | 3.612 [91.74] | 3.532 [89.71] | 3.400 [86.36] | .106 [2.69] | 3.306 [83.97] | 8-103168-3 | 8-102618-3 | 8-87589-1 |
| 72 | 3.712 [94.28] | 3.632 [92.25] | 3.500 [88.90] | .106 [2.69] | 3.406 [86.51] | 8-103168-4 | 8-102618-4 | 8-87589-2 |
| 74 | 3.812 [96.82] | 3.732 [94.79] | 3.600 [91.44] | .106 [2.69] | 3.506 [89.05] | 8-103168-5 | 8-102618-5 | 8-87589-3 |

Standard Profile Headers,
Shrouded

5

Standard Profile Headers—Shrouded, with .150 [3.81] End Dimension, Double-Row, .100 x .100 [2.54 x 2.54] Centerline

.025 [0.64] Square Straight Post (with Detent Windows)

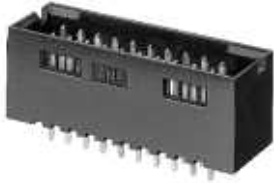

Material and Finish

Housing — Black thermoplastic, 94V-0 rated

Posts — Phosphor bronze, plated as follows:

Plating A — Duplex plated .000030 [0.00076] gold on contact area, .000100-.000200 [0.00254-0.00508] tin on solder area, with entire post underplated .000050 [0.00127] nickel

Plating B — Duplex plated .000015 [0.00038] gold on contact area, .000100-.000200 [0.00254-0.00508] tin on solder area, with entire post underplated .000050 [0.00127] nickel

Plating C — .000100-.000200 [0.00254-0.00508] tin over .000050 [0.00127] nickel on entire post

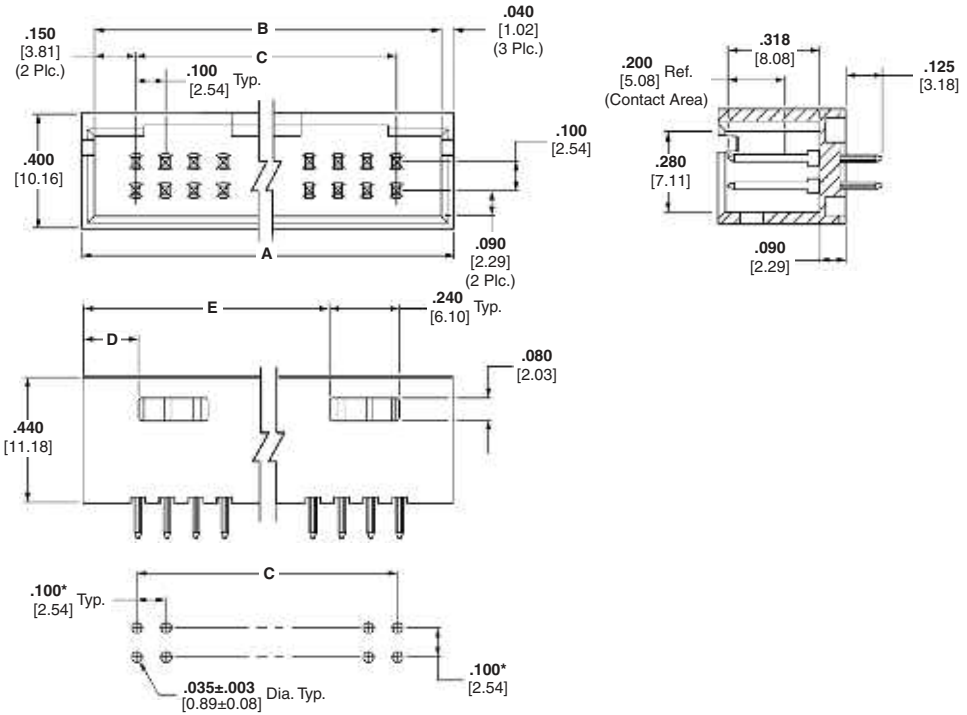

Recommended PC Board Hole Layout (for .055 [1.40] min. thick PC board)

*±.003 [±0.08] tolerances not to accumulate within one connector pattern.

Related Product Data

Mateable Connectors

AMPMODU MTE Receptacles — pages 232, 233, 235 (used with coupling shroud on page 241)

AMPMODU Wire-Applied Receptacles — pages 216-219

Accessories

Barrier Insert — page 204

Technical Documents — page 276

See mating connector for applicable product and application specifications.

| No. of Pos. | Dimensions | | | | | Post Plating/Part Nos. | | |
|-------------|---------------|---------------|---------------|--------------|---------------|------------------------|------------|-----------|
| | A | B | C | D | E | Plating A | Plating B | Plating C |
| 6 | .580 [14.73] | .500 [12.70] | .200 [5.08] | .190 [4.83] | — | 5-103169-1 | 5-102619-1 | 8-87587-3 |
| 8 | .680 [17.27] | .600 [15.24] | .300 [7.62] | .190 [4.83] | — | 5-103169-2 | 5-102619-2 | 8-87587-4 |
| 10 | .780 [19.81] | .700 [17.78] | .400 [10.16] | .290 [7.37] | — | 5-103169-3 | 5-102619-3 | 5-87587-1 |
| 12 | .880 [22.35] | .800 [20.32] | .500 [12.70] | .290 [7.37] | — | 5-103169-4 | 5-102619-4 | 5-87587-2 |
| 14 | .980 [24.89] | .900 [22.86] | .600 [15.24] | .390 [9.91] | — | 5-103169-5 | 5-102619-5 | 5-87587-3 |
| 16 | 1.080 [27.43] | 1.000 [25.40] | .700 [17.78] | .390 [9.91] | — | 5-103169-6 | 5-102619-6 | 5-87587-4 |
| 18 | 1.180 [29.97] | 1.100 [27.94] | .800 [20.32] | .490 [12.45] | — | 5-103169-7 | 5-102619-7 | 5-87587-5 |
| 20 | 1.280 [32.51] | 1.200 [30.48] | .900 [22.86] | .190 [4.83] | .890 [22.61] | 5-103169-8 | 5-102619-8 | 5-87587-6 |
| 22 | 1.380 [35.05] | 1.300 [33.02] | 1.000 [25.40] | .190 [4.83] | .990 [25.15] | 5-103169-9 | 5-102619-9 | 5-87587-7 |
| 24 | 1.480 [37.59] | 1.400 [35.56] | 1.100 [27.94] | .190 [4.83] | 1.090 [27.69] | 6-103169-0 | 6-102619-0 | 5-87587-8 |
| 26 | 1.580 [40.13] | 1.500 [38.10] | 1.200 [30.48] | .190 [4.83] | 1.190 [30.23] | 6-103169-1 | 6-102619-1 | 5-87587-9 |
| 28 | 1.680 [42.67] | 1.600 [40.64] | 1.300 [33.02] | .190 [4.83] | 1.290 [32.77] | 6-103169-2 | 6-102619-2 | 6-87587-0 |
| 30 | 1.780 [45.21] | 1.700 [43.18] | 1.400 [35.56] | .190 [4.83] | 1.390 [35.31] | 6-103169-3 | 6-102619-3 | 6-87587-1 |

Note: All part numbers are RoHS compliant.

Standard Profile Headers—Shrouded, with .150 [3.81] End Dimension, Double-Row, .100 x .100 [2.54 x 2.54] Centerline (Continued)

| No. of Pos. | Dimensions | | | | | Post Plating/Part Nos. | | |
|-------------|---------------|---------------|---------------|-------------|---------------|------------------------|------------|-----------|
| | A | B | C | D | E | Plating A | Plating B | Plating C |
| 32 | 1.880 [47.75] | 1.800 [45.72] | 1.500 [38.10] | .190 [4.83] | 1.490 [37.85] | 6-103169-4 | 6-102619-4 | 6-87587-2 |
| 34 | 1.980 [50.29] | 1.900 [48.26] | 1.600 [40.64] | .190 [4.83] | 1.590 [40.39] | 6-103169-5 | 6-102619-5 | 6-87587-3 |
| 36 | 2.080 [52.83] | 2.000 [50.80] | 1.700 [43.18] | .190 [4.83] | 1.690 [42.93] | 6-103169-6 | 6-102619-6 | 6-87587-4 |
| 38 | 2.180 [55.37] | 2.100 [53.34] | 1.800 [45.72] | .190 [4.83] | 1.790 [45.47] | 6-103169-7 | 6-102619-7 | 6-87587-5 |
| 40 | 2.280 [57.91] | 2.200 [55.88] | 1.900 [48.26] | .190 [4.83] | 1.890 [48.01] | 6-103169-8 | 6-102619-8 | 6-87587-6 |
| 42 | 2.380 [60.45] | 2.300 [58.42] | 2.000 [50.80] | .190 [4.83] | 1.990 [50.55] | 6-103169-9 | 6-102619-9 | 6-87587-7 |
| 44 | 2.480 [62.99] | 2.400 [60.96] | 2.100 [53.34] | .190 [4.83] | 2.090 [53.09] | 7-103169-0 | 7-102619-0 | 6-87587-8 |
| 46 | 2.580 [65.53] | 2.500 [63.50] | 2.200 [55.88] | .190 [4.83] | 2.190 [55.63] | 7-103169-1 | 7-102619-1 | 6-87587-9 |
| 48 | 2.680 [68.07] | 2.600 [66.04] | 2.300 [58.42] | .190 [4.83] | 2.290 [58.17] | 7-103169-2 | 7-102619-2 | 7-87587-0 |
| 50 | 2.780 [70.61] | 2.700 [68.58] | 2.400 [60.96] | .190 [4.83] | 2.390 [60.71] | 7-103169-3 | 7-102619-3 | 7-87587-1 |
| 52 | 2.880 [73.15] | 2.800 [71.12] | 2.500 [63.50] | .190 [4.83] | 2.490 [63.25] | 7-103169-4 | 7-102619-4 | 7-87587-2 |
| 54 | 2.980 [75.69] | 2.900 [73.66] | 2.600 [66.04] | .190 [4.83] | 2.590 [65.79] | 7-103169-5 | 7-102619-5 | 7-87587-3 |
| 56 | 3.080 [78.23] | 3.000 [76.20] | 2.700 [68.58] | .190 [4.83] | 2.690 [68.33] | 7-103169-6 | 7-102619-6 | 7-87587-4 |
| 58 | 3.180 [80.77] | 3.100 [78.74] | 2.800 [71.12] | .190 [4.83] | 2.790 [70.87] | 7-103169-7 | 7-102619-7 | 7-87587-5 |
| 60 | 3.280 [83.31] | 3.200 [81.28] | 2.900 [73.66] | .190 [4.83] | 2.890 [73.41] | 7-103169-8 | 7-102619-8 | 7-87587-6 |
| 62 | 3.380 [85.85] | 3.300 [83.82] | 3.000 [76.20] | .190 [4.83] | 2.990 [75.95] | 7-103169-9 | 7-102619-9 | 7-87587-7 |
| 64 | 3.480 [88.39] | 3.400 [86.36] | 3.100 [78.74] | .190 [4.83] | 3.090 [78.49] | 8-103169-0 | 8-102619-0 | 7-87587-8 |
| 66 | 3.580 [90.93] | 3.500 [88.90] | 3.200 [81.28] | .190 [4.83] | 3.190 [81.03] | 8-103169-1 | 8-102619-1 | 7-87587-9 |
| 68 | 3.680 [93.47] | 3.600 [91.44] | 3.300 [83.82] | .190 [4.83] | 3.290 [83.57] | 8-103169-2 | 8-102619-2 | 8-87587-0 |
| 70 | 3.780 [96.01] | 3.700 [93.98] | 3.400 [86.36] | .190 [4.83] | 3.390 [86.11] | 8-103169-3 | 8-102619-3 | 8-87587-1 |
| 72 | 3.880 [98.55] | 3.800 [96.52] | 3.500 [88.90] | .190 [4.83] | 3.490 [88.65] | 8-103169-4 | 8-102619-4 | 8-87587-2 |

Standard Profile Headers,
Shrouded

5

Note: All part numbers are RoHS compliant.

Standard Profile Headers—Shrouded, with .150 [3.81] End Dimension, Double-Row, .100 x .100 [2.54 x 2.54] Centerline (Continued)

.025 [0.64] Square Straight Post (with Plastic Holddowns)

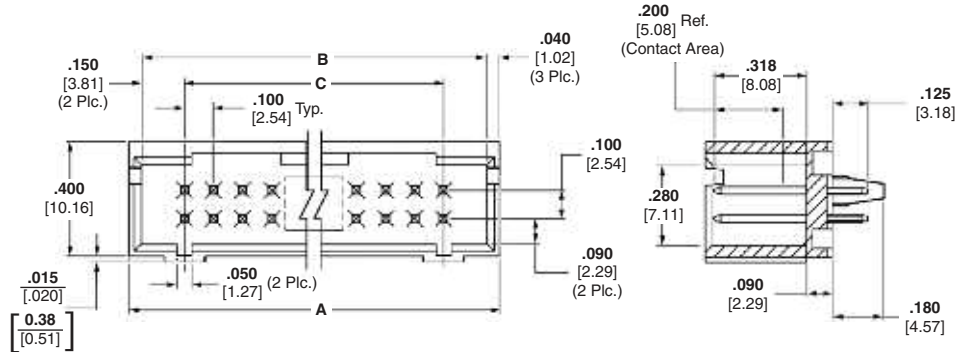

Material and Finish

Housing — Black thermoplastic, 94V-0 rated

Posts — Phosphor bronze, duplex plated .000015 [0.00038] gold on contact area, .000100-.000200 [0.00254-0.00508] tin on solder area, with entire post underplated .000050 [0.00127] nickel

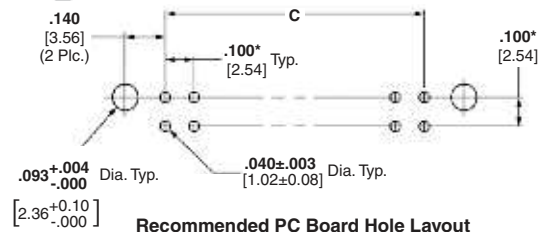
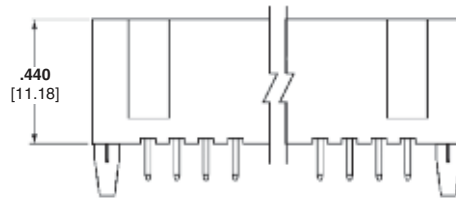

Recommended PC Board Hole Layout (for .055 [1.40] min. thick PC board)

*±.003 [±0.08] tolerances not to accumulate within one connector pattern.

Related Product Data

Mateable Connectors

AMPMODU MTE Receptacles — pages 232, 233, 235 (used with coupling shroud on page 241)

AMPMODU Wire-Applied Receptacles — pages 216-219

Accessories

Barrier Insert — page 204

Technical Documents — page 276

See mating connector for applicable product and application specifications.

| No. of Pos. | Dimensions | | | Part Nos. Plating A |
|-------------|---------------|---------------|---------------|---------------------|
| | A | B | C | |
| 6 | .580 [14.73] | .500 [12.70] | .200 [5.08] | 5-104317-1 |
| 10 | .780 [19.81] | .700 [17.78] | .400 [10.16] | 5-104317-2 |
| 12 | .880 [22.35] | .800 [20.32] | .500 [12.70] | 5-104317-3 |
| 14 | .980 [24.89] | .900 [22.86] | .600 [15.24] | 5-104317-4 |
| 16 | 1.080 [27.43] | 1.000 [25.40] | .700 [17.78] | 6-104317-6 |
| 18 | 1.180 [29.97] | 1.100 [27.94] | .800 [20.32] | 5-104317-5 |
| 20 | 1.280 [32.51] | 1.200 [30.48] | .900 [22.86] | 5-104317-6 |
| 22 | 1.380 [35.05] | 1.300 [33.02] | 1.000 [25.40] | 5-104317-7 |
| 24 | 1.480 [37.59] | 1.400 [35.56] | 1.100 [27.94] | 5-104317-8 |
| 26 | 1.580 [40.13] | 1.500 [38.10] | 1.200 [30.48] | 5-104317-9 |
| 30 | 1.780 [45.21] | 1.700 [43.18] | 1.400 [35.56] | 6-104317-0 |
| 32 | 1.880 [47.75] | 1.800 [45.72] | 1.500 [38.10] | 6-104317-1 |
| 34 | 1.980 [50.29] | 1.900 [48.26] | 1.600 [40.64] | 6-104317-8 |
| 36 | 2.080 [52.83] | 2.000 [50.80] | 1.700 [43.18] | 6-104317-7 |
| 40 | 2.280 [57.91] | 2.200 [55.88] | 1.900 [48.26] | 6-104317-2 |
| 42 | 2.380 [60.45] | 2.300 [58.42] | 2.000 [50.80] | 6-104317-5 |
| 48 | 2.680 [68.07] | 2.600 [66.04] | 2.300 [58.42] | 6-104317-3 |
| 50 | 2.780 [70.61] | 2.700 [68.58] | 2.400 [60.96] | 6-104317-4 |

Note: All part numbers are RoHS compliant.

Standard Profile Headers—Shrouded, with .066 [1.68] End Dimension, Double-Row, .100 x .100 [2.54 x 2.54] Centerline

.025 [0.64] Square Right-Angle Post (with Detent Windows)

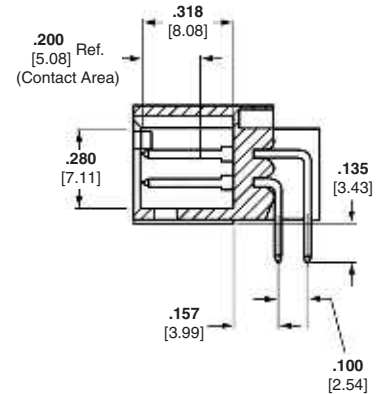
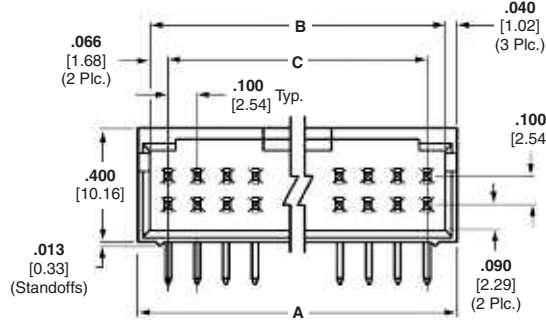

Material and Finish

Housing — Black thermoplastic, 94V-0 rated

Posts — Phosphor bronze, plated as follows:

Plating A — Duplex plated .000030 [0.00076] gold on contact area, .000100-.000200 [0.00254-0.00508] tin on solder area, with entire post underplated .000050 [0.00127] nickel

Plating B — Duplex plated .000015 [0.00038] gold on contact area, .000100-.000200 [0.00254-0.00508] tin on solder area, with entire post underplated .000050 [0.00127] nickel

Plating C — .000100-.000200 [0.00254-0.00508] tin over .000050 [0.00127] nickel on entire post

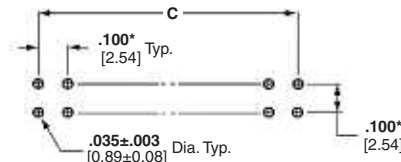
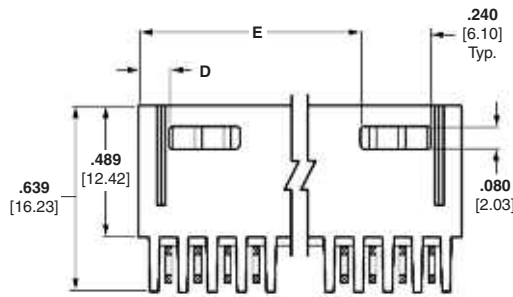

Recommended PC Board Hole Layout (for .055 [1.40] min. thick PC board)

*±.003 [±0.08] tolerances not to accumulate within one connector pattern.

Related Product Data

Mateable Connectors

AMPMODU Board Mount Receptacles — pages 176, 179, 180

AMPMODU Wire-Applied Receptacles — pages 216-219

AMPMODU MTE Receptacles — pages 228, 229, 234

AMPMODU MT Receptacles — pages 256, 257

Technical Documents — page 276

See mating connector for applicable product and application specifications.

| No. of Pos. | Dimensions | | | | | Post Plating/Part Nos. | | |
|-------------|---------------|---------------|---------------|--------------|---------------|------------------------|------------|-----------|
| | A | B | C | D | E | Plating A | Plating B | Plating C |
| 6 | .412 [10.46] | .332 [8.43] | .200 [5.08] | .106 [2.69] | — | 5-103166-1 | 5-102617-1 | 8-87579-5 |
| 8 | .512 [13.00] | .432 [10.97] | .300 [7.62] | .106 [2.69] | — | 5-103166-2 | 5-102617-2 | 5-87579-1 |
| 10 | .612 [15.54] | .532 [13.51] | .400 [10.16] | .206 [5.23] | — | 5-103166-3 | 5-102617-3 | 5-87579-2 |
| 12 | .712 [18.08] | .632 [16.05] | .500 [12.70] | .206 [5.23] | — | 5-103166-4 | 5-102617-4 | 5-87579-3 |
| 14 | .812 [20.62] | .732 [18.59] | .600 [15.24] | .306 [7.77] | — | 5-103166-5 | 5-102617-5 | 5-87579-4 |
| 16 | .912 [23.16] | .832 [21.13] | .700 [17.78] | .306 [7.77] | — | 5-103166-6 | 5-102617-6 | 5-87579-5 |
| 18 | 1.012 [25.70] | .932 [23.67] | .800 [20.32] | .406 [10.31] | — | 5-103166-7 | 5-102617-7 | 5-87579-6 |
| 20 | 1.112 [28.24] | 1.032 [26.21] | .900 [22.86] | .106 [2.69] | .806 [20.47] | 5-103166-8 | 5-102617-8 | 5-87579-7 |
| 22 | 1.212 [30.78] | 1.132 [28.75] | 1.000 [25.40] | .106 [2.69] | .906 [23.01] | 5-103166-9 | 5-102617-9 | 5-87579-8 |
| 24 | 1.312 [33.32] | 1.232 [31.29] | 1.100 [27.94] | .106 [2.69] | 1.006 [25.55] | 6-103166-0 | 6-102617-0 | 5-87579-9 |
| 26 | 1.412 [35.86] | 1.332 [33.83] | 1.200 [30.48] | .106 [2.69] | 1.106 [28.09] | 6-103166-1 | 6-102617-1 | 6-87579-0 |
| 28 | 1.512 [38.40] | 1.432 [36.37] | 1.300 [33.02] | .106 [2.69] | 1.206 [30.63] | 6-103166-2 | 6-102617-2 | 6-87579-1 |
| 30 | 1.612 [40.94] | 1.532 [38.91] | 1.400 [35.56] | .106 [2.69] | 1.306 [33.17] | 6-103166-3 | 6-102617-3 | 6-87579-2 |

Note: All part numbers are RoHS compliant.

Standard Profile Headers—Shrouded, with .066 [1.68] End Dimension, Double-Row, .100 x .100 [2.54 x 2.54] Centerline (Continued)

| No. of Pos. | Dimensions | | | | | Post Plating/Part Nos. | | |
|-------------|---------------|---------------|---------------|-------------|---------------|------------------------|------------|-----------|
| | A | B | C | D | E | Plating A | Plating B | Plating C |
| 32 | 1.712 [43.48] | 1.632 [41.45] | 1.500 [38.10] | .106 [2.69] | 1.406 [35.71] | 6-103166-4 | 6-102617-4 | 6-87579-3 |
| 34 | 1.812 [46.02] | 1.732 [43.99] | 1.600 [40.64] | .106 [2.69] | 1.506 [38.25] | 6-103166-5 | 6-102617-5 | 6-87579-4 |
| 36 | 1.912 [48.56] | 1.832 [46.53] | 1.700 [43.18] | .106 [2.69] | 1.606 [40.79] | 6-103166-6 | 6-102617-6 | 6-87579-5 |
| 38 | 2.012 [51.10] | 1.932 [49.07] | 1.800 [45.72] | .106 [2.69] | 1.706 [43.33] | 6-103166-7 | 6-102617-7 | 6-87579-6 |
| 40 | 2.112 [53.64] | 2.032 [51.61] | 1.900 [48.26] | .106 [2.69] | 1.806 [45.87] | 6-103166-8 | 6-102617-8 | 6-87579-7 |
| 42 | 2.212 [56.18] | 2.132 [54.15] | 2.000 [50.80] | .106 [2.69] | 1.906 [48.41] | 6-103166-9 | 6-102617-9 | 6-87579-8 |
| 44 | 2.312 [58.72] | 2.232 [56.69] | 2.100 [53.34] | .106 [2.69] | 2.006 [50.95] | 7-103166-0 | 7-102617-0 | 6-87579-9 |
| 46 | 2.412 [61.26] | 2.332 [59.23] | 2.200 [55.88] | .106 [2.69] | 2.106 [53.49] | 7-103166-1 | 7-102617-1 | 7-87579-0 |
| 48 | 2.512 [63.80] | 2.432 [61.77] | 2.300 [58.42] | .106 [2.69] | 2.206 [56.03] | 7-103166-2 | 7-102617-2 | 7-87579-1 |
| 50 | 2.612 [66.34] | 2.532 [64.31] | 2.400 [60.96] | .106 [2.69] | 2.306 [58.57] | 7-103166-3 | 7-102617-3 | 7-87579-2 |
| 52 | 2.712 [68.88] | 2.632 [66.85] | 2.500 [63.50] | .106 [2.69] | 2.406 [61.11] | 7-103166-4 | 7-102617-4 | 7-87579-3 |
| 54 | 2.812 [71.42] | 2.732 [69.39] | 2.600 [66.04] | .106 [2.69] | 2.506 [63.65] | 7-103166-5 | 7-102617-5 | 7-87579-4 |
| 56 | 2.912 [73.96] | 2.832 [71.93] | 2.700 [68.58] | .106 [2.69] | 2.606 [66.19] | 7-103166-6 | 7-102617-6 | 7-87579-5 |
| 58 | 3.012 [76.50] | 2.932 [74.47] | 2.800 [71.12] | .106 [2.69] | 2.706 [68.73] | 7-103166-7 | 7-102617-7 | 7-87579-6 |
| 60 | 3.112 [79.04] | 3.032 [77.01] | 2.900 [73.66] | .106 [2.69] | 2.806 [71.27] | 7-103166-8 | 7-102617-8 | 7-87579-7 |
| 62 | 3.212 [81.58] | 3.132 [79.55] | 3.000 [76.20] | .106 [2.69] | 2.906 [73.81] | 7-103166-9 | 7-102617-9 | 7-87579-8 |
| 64 | 3.312 [84.12] | 3.232 [82.09] | 3.100 [78.74] | .106 [2.69] | 3.006 [76.35] | 8-103166-0 | 8-102617-0 | 7-87579-9 |
| 66 | 3.412 [86.66] | 3.332 [84.63] | 3.200 [81.28] | .106 [2.69] | 3.106 [78.89] | 8-103166-1 | 8-102617-1 | 8-87579-0 |
| 68 | 3.512 [89.20] | 3.432 [87.17] | 3.300 [83.82] | .106 [2.69] | 3.206 [81.43] | 8-103166-2 | 8-102617-2 | 8-87579-1 |
| 70 | 3.612 [91.74] | 3.532 [89.71] | 3.400 [86.36] | .106 [2.69] | 3.306 [83.97] | 8-103166-3 | 8-102617-3 | 8-87579-2 |
| 72 | 3.712 [94.28] | 3.632 [92.25] | 3.500 [88.90] | .106 [2.69] | 3.406 [86.51] | 8-103166-4 | 8-102617-4 | 8-87579-3 |
| 74 | 3.812 [96.82] | 3.732 [94.79] | 3.600 [91.44] | .106 [2.69] | 3.506 [89.05] | 8-103166-5 | 8-102617-5 | 8-87579-4 |

Standard Profile Headers, Shrouded

5

Note: All part numbers are RoHS compliant.

Standard Profile Headers—Shrouded, with .150 [3.81] End Dimension, Double-Row, .100 x .100 [2.54 x 2.54] Centerline

.025 [0.64] Square Right-Angle Post (with Detent Windows)

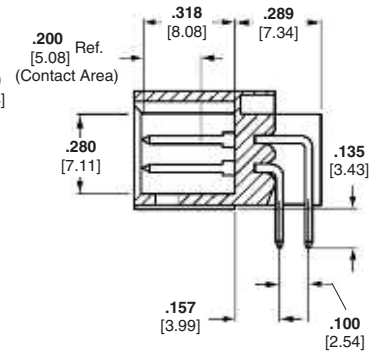
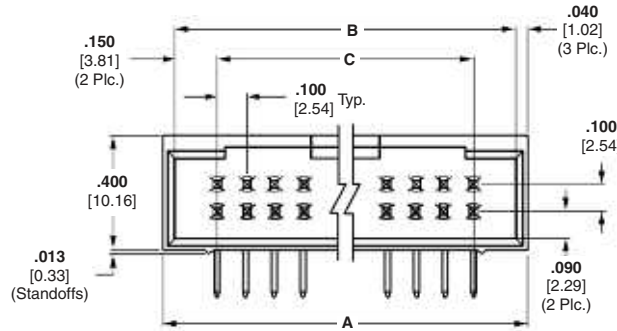

Material and Finish

Housing — Black thermoplastic, 94V-0 rated

Posts — Phosphor bronze, plated as follows:

Plating A — Duplex plated .000030 [0.00076] gold on contact area, .000100-.000200 [0.00254-0.00508] tin on solder area, with entire post underplated .000050 [0.00127] nickel

Plating B — Duplex plated .000015 [0.00038] gold on contact area, .000100-.000200 [0.00254-0.00508] tin on solder area, with entire post underplated .000050 [0.00127] nickel

Plating C — .000100-.000200 [0.00254-0.00508] tin over .000050 [0.00127] nickel on entire post

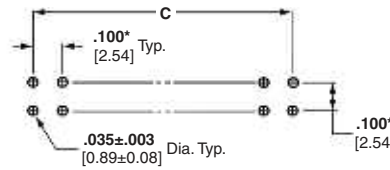
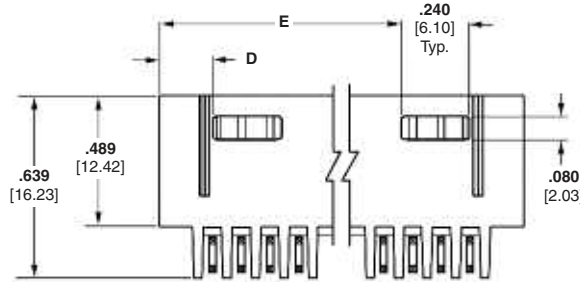

Recommended PC Board Hole Layout (for .055 [1.40] min. thick PC board)

*±.003 [±0.08] tolerances not to accumulate within one connector pattern.

Related Product Data

Mateable Connectors

AMPMODU MTE Receptacles — pages 232, 233, 235 (used with coupling shroud on page 241)

AMPMODU Wire-Applied Receptacles — pages 216-219

Technical Documents — page 276

See mating connector for applicable product and application specifications.

| No. of Pos. | Dimensions | | | | | Post Plating/Part Nos. | | |
|-------------|---------------|---------------|---------------|--------------|---------------|------------------------|------------|-----------|
| | A | B | C | D | E | Plating A | Plating B | Plating C |
| 8 | .680 [17.27] | .600 [15.24] | .300 [7.62] | .190 [4.83] | — | 5-103167-1 | 5-102570-2 | 5-87577-1 |
| 10 | .780 [19.81] | .700 [17.78] | .400 [10.16] | .290 [7.37] | — | 5-103167-2 | 5-102570-3 | 5-87577-2 |
| 12 | .880 [22.35] | .800 [20.32] | .500 [12.70] | .290 [7.37] | — | 5-103167-3 | 5-102570-4 | 5-87577-3 |
| 14 | .980 [24.89] | .900 [22.86] | .600 [15.24] | .390 [9.91] | — | 5-103167-4 | 5-102570-5 | 5-87577-4 |
| 16 | 1.080 [27.43] | 1.000 [25.40] | .700 [17.78] | .390 [9.91] | — | 5-103167-5 | 5-102570-6 | 5-87577-5 |
| 18 | 1.180 [29.97] | 1.100 [27.94] | .800 [20.32] | .490 [12.45] | — | 5-103167-6 | 5-102570-7 | 5-87577-6 |
| 20 | 1.280 [32.51] | 1.200 [30.48] | .900 [22.86] | .190 [4.83] | .890 [22.61] | 5-103167-7 | 5-102570-8 | 5-87577-7 |
| 22 | 1.380 [35.05] | 1.300 [33.02] | 1.000 [25.40] | .190 [4.83] | .990 [25.15] | 5-103167-8 | 5-102570-9 | 5-87577-8 |
| 24 | 1.480 [37.59] | 1.400 [35.56] | 1.100 [27.94] | .190 [4.83] | 1.090 [27.69] | 5-103167-9 | 6-102570-0 | 5-87577-9 |
| 26 | 1.580 [40.13] | 1.500 [38.10] | 1.200 [30.48] | .190 [4.83] | 1.190 [30.23] | 6-103167-0 | 6-102570-1 | 6-87577-0 |
| 28 | 1.680 [42.67] | 1.600 [40.64] | 1.300 [33.02] | .190 [4.83] | 1.290 [32.77] | 6-103167-1 | 6-102570-2 | 6-87577-1 |
| 30 | 1.780 [45.21] | 1.700 [43.18] | 1.400 [35.56] | .190 [4.83] | 1.390 [35.31] | 6-103167-2 | 6-102570-3 | 6-87577-2 |

Note: All part numbers are RoHS compliant.

Standard Profile Headers—Shrouded, with .150 [3.81] End Dimension, Double-Row, .100 x .100 [2.54 x 2.54] Centerline (Continued)

| No. of Pos. | Dimensions | | | | | Post Plating/Part Nos. | | |
|-------------|---------------|---------------|---------------|-------------|---------------|------------------------|------------|-----------|
| | A | B | C | D | E | Plating A | Plating B | Plating C |
| 32 | 1.880 [47.75] | 1.800 [45.72] | 1.500 [38.10] | .190 [4.83] | 1.490 [37.85] | 6-103167-3 | 6-102570-4 | 6-87577-3 |
| 34 | 1.980 [50.29] | 1.900 [48.26] | 1.600 [40.64] | .190 [4.83] | 1.590 [40.39] | 6-103167-4 | 6-102570-5 | 6-87577-4 |
| 36 | 2.080 [52.83] | 2.000 [50.80] | 1.700 [43.18] | .190 [4.83] | 1.690 [42.93] | 6-103167-5 | 6-102570-6 | 6-87577-5 |
| 38 | 2.180 [55.37] | 2.100 [53.34] | 1.800 [45.72] | .190 [4.83] | 1.790 [45.47] | 6-103167-6 | 6-102570-7 | 6-87577-6 |
| 40 | 2.280 [57.91] | 2.200 [55.88] | 1.900 [48.26] | .190 [4.83] | 1.890 [48.01] | 6-103167-7 | 5-102570-1 | 6-87577-7 |
| 42 | 2.380 [60.45] | 2.300 [58.42] | 2.000 [50.80] | .190 [4.83] | 1.990 [50.55] | 6-103167-8 | 6-102570-8 | 6-87577-8 |
| 44 | 2.480 [62.99] | 2.400 [60.96] | 2.100 [53.34] | .190 [4.83] | 2.090 [53.09] | 6-103167-9 | 6-102570-9 | 6-87577-9 |
| 46 | 2.580 [65.53] | 2.500 [63.50] | 2.200 [55.88] | .190 [4.83] | 2.190 [55.63] | 7-103167-0 | 7-102570-0 | 7-87577-0 |
| 48 | 2.680 [68.07] | 2.600 [66.04] | 2.300 [58.42] | .190 [4.83] | 2.290 [58.17] | 7-103167-1 | 7-102570-1 | 7-87577-1 |
| 50 | 2.780 [70.61] | 2.700 [68.58] | 2.400 [60.96] | .190 [4.83] | 2.390 [60.71] | 7-103167-2 | 7-102570-2 | 7-87577-2 |
| 52 | 2.880 [73.15] | 2.800 [71.12] | 2.500 [63.50] | .190 [4.83] | 2.490 [63.25] | 7-103167-3 | 7-102570-3 | 7-87577-3 |
| 54 | 2.980 [75.69] | 2.900 [73.66] | 2.600 [66.04] | .190 [4.83] | 2.590 [65.79] | 7-103167-4 | 7-102570-4 | 7-87577-4 |
| 56 | 3.080 [78.23] | 3.000 [76.20] | 2.700 [68.58] | .190 [4.83] | 2.690 [68.33] | 7-103167-5 | 7-102570-5 | 7-87577-5 |
| 58 | 3.180 [80.77] | 3.100 [78.74] | 2.800 [71.12] | .190 [4.83] | 2.790 [70.87] | 7-103167-6 | 7-102570-6 | 7-87577-6 |
| 60 | 3.280 [83.31] | 3.200 [81.28] | 2.900 [73.66] | .190 [4.83] | 2.890 [73.41] | 7-103167-7 | 7-102570-7 | 7-87577-7 |
| 62 | 3.380 [85.85] | 3.300 [83.82] | 3.000 [76.20] | .190 [4.83] | 2.990 [75.95] | 7-103167-8 | 7-102570-8 | 7-87577-8 |
| 64 | 3.480 [88.39] | 3.400 [86.36] | 3.100 [78.74] | .190 [4.83] | 3.090 [78.49] | 7-103167-9 | 7-102570-9 | 7-87577-9 |
| 66 | 3.580 [90.93] | 3.500 [88.90] | 3.200 [81.28] | .190 [4.83] | 3.190 [81.03] | 8-103167-0 | 8-102570-0 | 8-87577-0 |
| 68 | 3.680 [93.47] | 3.600 [91.44] | 3.300 [83.82] | .190 [4.83] | 3.290 [83.57] | 8-103167-1 | 8-102570-1 | 8-87577-1 |
| 70 | 3.780 [96.01] | 3.700 [93.98] | 3.400 [86.36] | .190 [4.83] | 3.390 [86.11] | 8-103167-2 | 8-102570-2 | 8-87577-2 |
| 72 | 3.880 [98.55] | 3.800 [96.52] | 3.500 [88.90] | .190 [4.83] | 3.490 [88.65] | 8-103167-3 | 8-102570-3 | 8-87577-3 |

Standard Profile Headers, Shrouded

5

Note: All part numbers are RoHS compliant.

Standard Profile Headers—Shrouded, with .066 [1.68] End Dimension, Double-Row, .100 x .100 [2.54 x 2.54] Centerline

.025 [0.64] Square Right-Angle Post (with Pin Protection on 3 Sides)

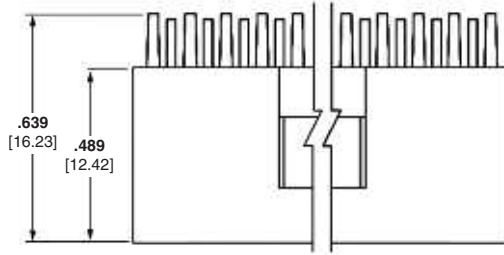

Material and Finish

Housing — Black thermoplastic, 94V-0 rated

Posts — Phosphor bronze, plated as follows:

Plating A — Duplex plated .000030 [0.00076] gold on contact area, .000100-.000200 [0.00254-0.00508] tin on solder area, with entire post underplated .000050 [0.00127] nickel

Plating B — Duplex plated .000015 [0.00038] gold on contact area, .000100-.000200 [0.00254-0.00508] tin on solder area, with entire post underplated .000050 [0.00127] nickel

Plating C — .000100-.000200 [0.00254-0.00508] tin over .000050 [0.00127] nickel on entire post

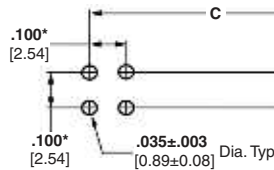
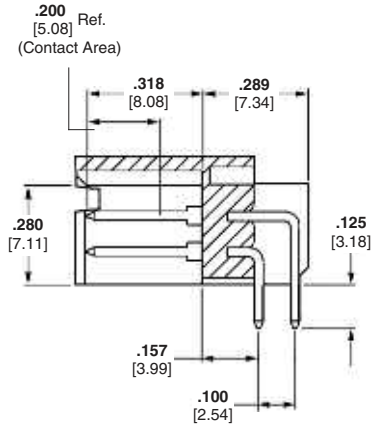
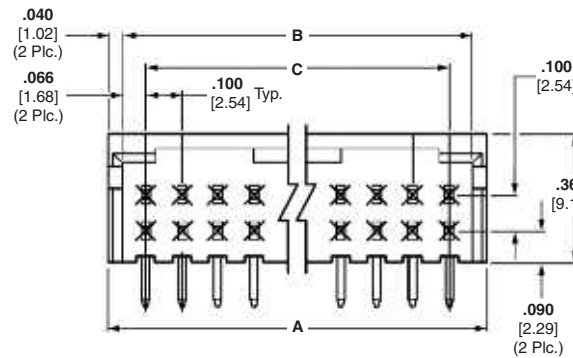

Recommended PC Board Hole Layout (for .055 [1.40] min. thick PC board)

*±.003 [±0.08] tolerances not to accumulate within one connector pattern.

Related Product Data

Mateable Connectors

AMPMODU Board Mount

Receptacles — pages 176, 179, 180

AMPMODU Wire-Applied Receptacles — pages 216, 217

AMPMODU MTE Receptacles — pages 228, 229, 234

AMPMODU MT Receptacles — pages 256, 257

Technical Documents — page 276

See mating connector for applicable product and application specifications.

| No. of Pos. | Dimensions | | | Post Plating/Part Nos. | | |
|-------------|---------------|---------------|---------------|------------------------|------------|-----------|
| | A | B | C | Plating A | Plating B | Plating C |
| 6 | .412 [10.46] | .332 [8.43] | .200 [5.08] | 5-103164-1 | 5-102055-2 | 8-87572-5 |
| 8 | .512 [13.00] | .432 [10.97] | .300 [7.62] | 5-103164-2 | 5-102055-3 | 5-87572-1 |
| 10 | .612 [15.54] | .532 [13.51] | .400 [10.16] | 5-103164-3 | 5-102055-4 | 5-87572-2 |
| 12 | .712 [18.08] | .632 [16.05] | .500 [12.70] | 5-103164-4 | 5-102055-5 | 5-87572-3 |
| 14 | .812 [20.62] | .732 [18.59] | .600 [15.24] | 5-103164-5 | 5-102055-6 | 5-87572-4 |
| 16 | .912 [23.16] | .832 [21.13] | .700 [17.78] | 5-103164-6 | 5-102055-7 | 5-87572-5 |
| 18 | 1.012 [25.70] | .932 [23.67] | .800 [20.32] | 5-103164-7 | 5-102055-8 | 5-87572-6 |
| 20 | 1.112 [28.24] | 1.032 [26.21] | .900 [22.86] | 5-103164-8 | 5-102055-1 | 5-87572-7 |
| 24 | 1.312 [33.32] | 1.232 [31.29] | 1.100 [27.94] | 6-103164-0 | 6-102055-0 | — |
| 26 | 1.412 [35.86] | 1.332 [33.83] | 1.200 [30.48] | 6-103164-1 | — | 6-87572-0 |
| 30 | 1.612 [40.94] | 1.532 [38.91] | 1.400 [35.56] | 6-103164-3 | 6-102055-3 | — |
| 34 | 1.812 [46.02] | 1.732 [43.99] | 1.600 [40.64] | 6-103164-5 | 6-102055-5 | 6-87572-4 |
| 40 | 2.112 [53.64] | 2.032 [51.61] | 1.900 [48.26] | 6-103164-8 | 6-102055-8 | 6-87572-7 |
| 50 | 2.612 [66.34] | 2.532 [64.31] | 2.400 [60.96] | 7-103164-3 | 7-102055-3 | 7-87572-2 |
| 52 | 2.712 [68.88] | 2.632 [66.85] | 2.500 [63.50] | 7-103164-4 | — | — |
| 54 | 2.812 [71.42] | 2.732 [69.36] | 2.600 [66.04] | — | 7-102055-5 | — |
| 60 | 3.112 [79.04] | 3.032 [77.01] | 2.900 [73.66] | 7-103164-8 | 7-102055-8 | 7-87572-7 |

Note: All part numbers are RoHS compliant.

Standard Profile Headers—Shrouded, with .150 [3.81] End Dimension, Double-Row, .100 x .100 [2.54 x 2.54] Centerline

.025 [0.64] Square Right-Angle Post (with Pin Protection on 3 Sides)

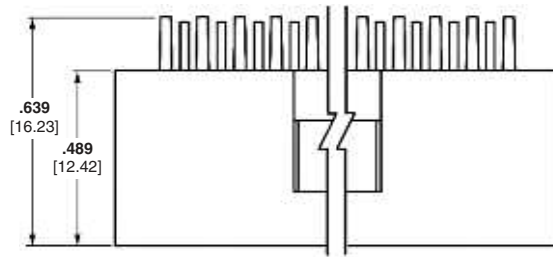

Material and Finish

Housing — Black thermoplastic, 94V-0 rated

Posts — Phosphor bronze, plated as follows:

Plating A — Duplex plated .000030 [0.00076] gold on contact area, .000100-.000200 [0.00254-0.00508] tin on solder area, with entire post underplated .000050 [0.00127] nickel

Plating B — Duplex plated .000015 [0.00038] gold on contact area, .000100-.000200 [0.00254-0.00508] tin on solder area, with entire post underplated .000050 [0.00127] nickel

Plating C — .000100-.000200 [0.00254-0.00508] tin over .000050 [0.00127] nickel on entire post

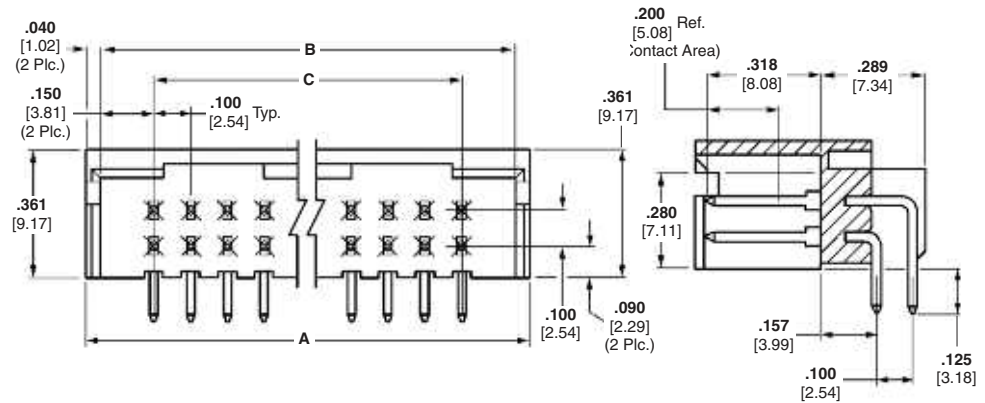

Related Product Data

Mateable Connectors

AMPMODU Wire-Applied

Receptacles — pages 216, 217

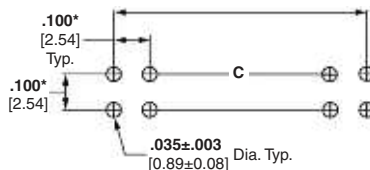

Recommended PC Board Hole Layout (for .055 [1.40] min. thick PC board)

*±.003 [±0.08] tolerances not to accumulate within one connector pattern.

Technical Documents — page 276

See mating connector for applicable product and application specifications.

| No. of Pos. | Dimensions | | | Post Plating/Part Nos. | | |
|-------------|---------------|---------------|---------------|------------------------|------------|-----------|
| | A | B | C | Plating A | Plating B | Plating C |
| 10 | .780 [19.81] | .700 [17.78] | .400 [10.16] | 5-103165-1 | 5-102620-1 | 5-87568-1 |
| 12 | .880 [22.35] | .800 [20.32] | .500 [12.70] | 5-103165-2 | 5-102620-2 | 5-87568-2 |
| 14 | .980 [24.89] | .900 [22.86] | .600 [15.24] | 5-103165-3 | 5-102620-3 | 5-87568-3 |
| 16 | 1.080 [27.43] | 1.000 [25.40] | .700 [17.78] | 5-103165-4 | 5-102620-4 | 5-87568-4 |
| 18 | 1.180 [29.97] | 1.100 [27.94] | .800 [20.32] | 5-103165-5 | 5-102620-5 | 5-87568-5 |
| 20 | 1.280 [32.51] | 1.200 [30.48] | .900 [22.86] | 5-103165-6 | 5-102620-6 | 5-87568-6 |
| 24 | 1.480 [37.59] | 1.400 [35.56] | 1.100 [27.94] | 5-103165-8 | 5-102620-8 | — |
| 26 | 1.580 [40.13] | 1.500 [38.10] | 1.200 [30.48] | 5-103165-9 | 5-102620-9 | 5-87568-9 |
| 30 | 1.780 [45.21] | 1.700 [43.18] | 1.400 [35.56] | 6-103165-1 | 6-102620-1 | — |
| 34 | 1.980 [50.29] | 1.900 [48.26] | 1.600 [40.64] | 6-103165-3 | 6-102620-3 | 6-87568-3 |
| 40 | 2.280 [57.91] | 2.200 [55.88] | 1.900 [48.26] | 6-103165-6 | 6-102620-6 | 6-87568-6 |
| 50 | 2.780 [70.61] | 2.700 [68.58] | 2.400 [60.96] | 7-103165-1 | 7-102620-1 | 7-87568-1 |
| 60 | 3.280 [83.31] | 3.200 [81.28] | 2.900 [73.66] | 7-103165-6 | 7-102620-6 | 7-87568-6 |

Note: All part numbers are RoHS compliant.

Standard Profile Headers—Shrouded, with .150 [3.81] End Dimension, Double-Row, .100 x .100 [2.54 x 2.54] Centerline

.025 [0.64] Square Right-Angle Post (with Plastic Holddowns)



Material and Finish

Housing — Black thermoplastic, 94V-0 rated

Posts — Phosphor bronze, duplex plated .000015 [0.00038] gold on contact area, .000100-.000200 [0.00254-0.00508] tin on solder area, with entire post underplated .000050 [0.00127] nickel

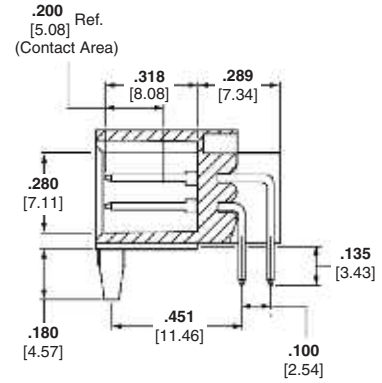
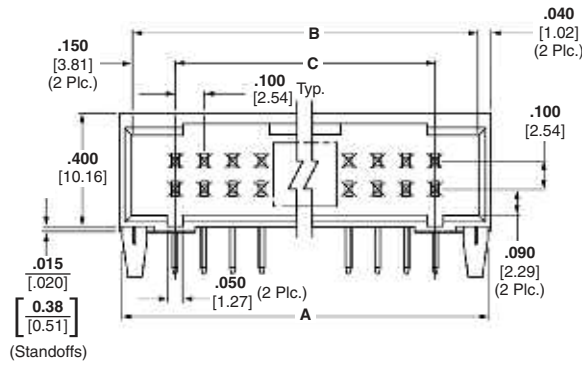
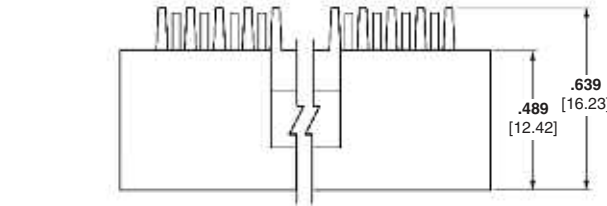

Related Product Data

Mateable Connectors

AMPMODU MTE Receptacles — pages 232, 233, 235 (used with coupling shroud on page 241)

AMPMODU Wire-Applied Receptacles — pages 216-219

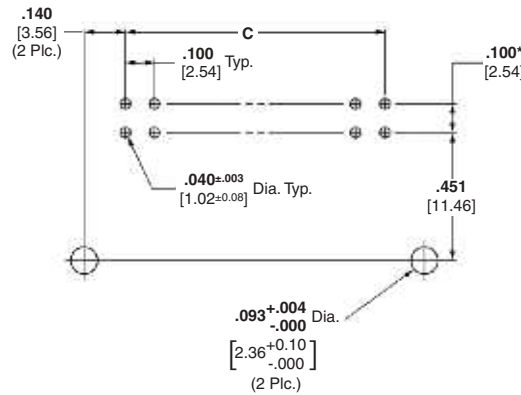

Recommended PC Board Hole Layout (for .055 [1.40] min. thick PC board)

*±.003 [±0.08] tolerances not to accumulate within one connector pattern.

Technical Documents — page 276

See mating connector for applicable product and application specifications.

Standard Profile Headers, Shrouded

5

| No. of Pos. | Dimensions | | | Part Nos. |
|-------------|---------------|---------------|---------------|------------|
| | A | B | C | |
| 10 | .780 [19.81] | .700 [17.78] | .400 [10.16] | 5-104319-7 |
| 12 | .880 [22.35] | .800 [20.32] | .500 [12.70] | 5-104319-8 |
| 14 | .980 [24.89] | .900 [22.86] | .600 [15.24] | 5-104319-5 |
| 16 | 1.080 [27.43] | 1.000 [25.40] | .700 [17.78] | 5-104319-1 |
| 20 | 1.280 [32.51] | 1.200 [30.48] | .900 [20.86] | 5-104319-2 |
| 30 | 1.780 [45.21] | 1.700 [43.18] | 1.400 [35.56] | 5-104319-3 |
| 34 | 1.980 [50.29] | 1.900 [48.26] | 1.600 [40.64] | 5-104319-6 |
| 40 | 2.280 [57.91] | 2.200 [55.88] | 1.900 [48.26] | 5-104319-4 |
| 48 | 2.680 [68.07] | 2.600 [66.04] | 2.300 [58.42] | 5-104319-9 |

Note: All part numbers are RoHS compliant.

Standard Profile Headers—Shrouded, with .150 [3.81] End Dimension, Double-Row, .100 x .100 [2.54 x 2.54] Centerline (Continued)

.025 [0.64] Square Straight Post (with Detent Windows and Mounting Ears)



Material and Finish

Housing — Black thermoplastic, 94V-0 rated

Posts — Copper alloy, plated .000030 [0.00076] gold over .000050 [0.00127] nickel on entire post

Related Product Data

Mateable Connectors

AMPMODU Wire-Applied Receptacles — pages 216-219

AMPMODU MTE Receptacles — pages 232, 233, 235 (used with coupling shroud on page 241)

Accessories

Barrier Insert — page 204

Technical Documents — page 276

See mating connector for applicable product and application specifications.

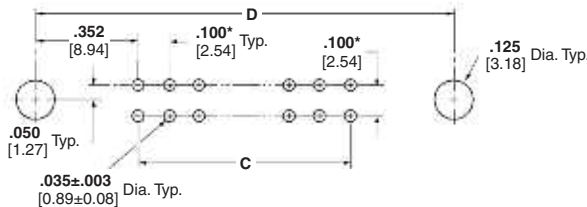
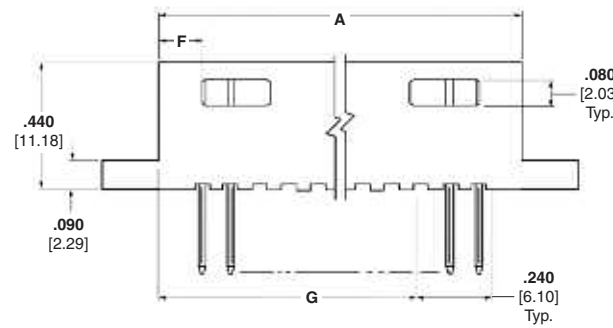
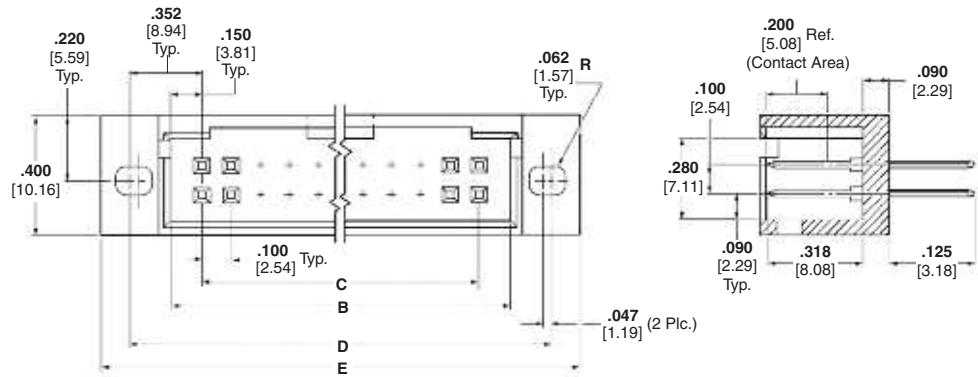

Recommended PC Board Hole Layout
(for .055 [1.40] min. thick PC board)

*±.003 [±0.08] tolerances not to accumulate within one connector pattern.

| No. of Pos. | Dimensions | | | | | | | Part Nos. |
|-------------|---------------|---------------|---------------|---------------|---------------|-------------|---------------|-----------|
| | A | B | C | D | E | F | G | |
| 10 | .780 [19.81] | .700 [17.78] | .400 [10.16] | 1.104 [28.04] | 1.304 [33.12] | .290 [7.37] | — | 87474-1 |
| 14 | .980 [24.89] | .900 [22.86] | .600 [15.24] | 1.304 [33.12] | 1.504 [38.20] | .190 [4.83] | — | 87474-9 |
| 20 | 1.280 [32.51] | 1.200 [30.48] | .900 [22.86] | 1.604 [40.74] | 1.804 [45.82] | .190 [4.83] | .890 [22.61] | 87474-2 |
| 24 | 1.480 [37.59] | 1.400 [35.56] | 1.100 [27.94] | 1.804 [45.82] | 2.004 [50.90] | .190 [4.83] | 1.090 [27.69] | 1-87474-3 |
| 26 | 1.580 [40.13] | 1.500 [38.10] | 1.200 [30.48] | 1.904 [48.36] | 2.104 [53.44] | .190 [4.83] | 1.190 [30.23] | 87474-3 |
| 34 | 1.980 [50.29] | 1.900 [48.26] | 1.600 [40.64] | 2.304 [58.52] | 2.504 [63.60] | .190 [4.83] | 1.590 [40.39] | 87474-4 |
| 40 | 2.280 [57.91] | 2.200 [55.88] | 1.900 [48.26] | 2.604 [66.14] | 2.804 [71.22] | .190 [4.83] | 1.890 [48.01] | 87474-6 |
| 50 | 2.780 [70.61] | 2.700 [68.58] | 2.400 [60.96] | 3.104 [78.84] | 3.304 [83.92] | .190 [4.83] | 2.390 [60.71] | 87474-7 |
| 60 | 3.280 [83.31] | 3.200 [81.28] | 2.900 [73.66] | 3.604 [91.54] | 3.804 [96.62] | .190 [4.83] | 2.890 [73.41] | 2-87474-6 |

Note: All part numbers are RoHS compliant.

Standard Profile Headers—Shrouded Bulkhead Type; with .066 [1.68] End Dimension, Double-Row, .100 x .100 [2.54 x 2.45] Centerline

.025 [0.64] Square Straight Post (with Detent Windows and Mounting Ears)

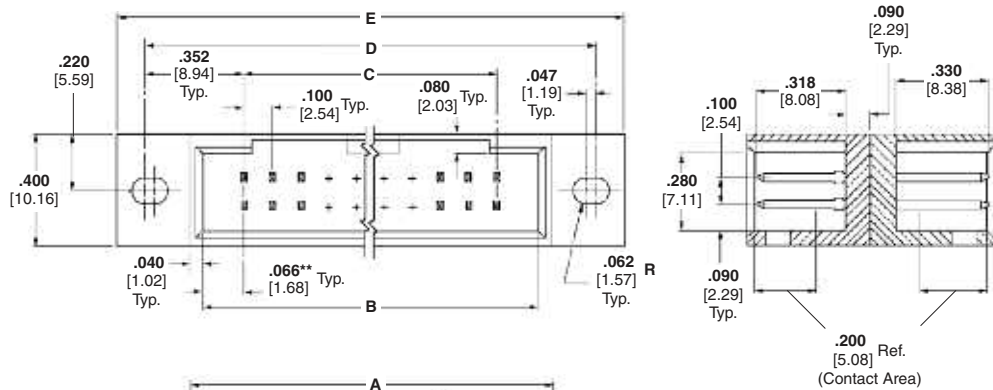

Material and Finish

Housing — Black thermoplastic, 94V-0 rated
Posts — Copper alloy, plated .000030 [0.00076] gold over .000050 [0.00127] nickel on entire post

Related Product Data

- Mateable Connectors**
- AMPMODU Board Mount Receptacles** — pages 176, 179, 180
- AMPMODU Wire-Applied Receptacles** — pages 216-219
- AMPMODU MTE Receptacles** — pages 228, 229, 234
- AMPMODU MT Receptacles** — pages 256, 257

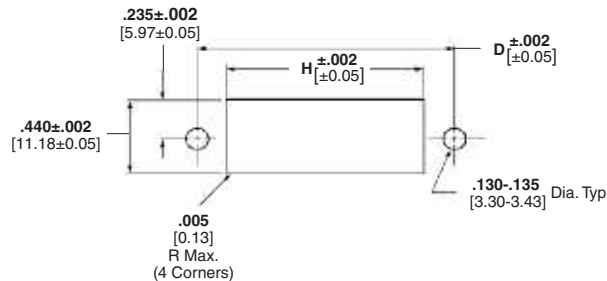
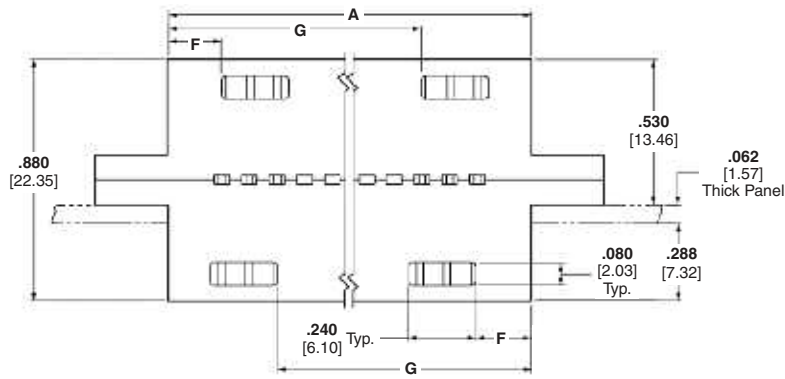

Recommended Panel Cutout

**Both mating faces have same end dimension.

Accessories

Barrier Insert — page 204

Technical Documents — page 276

See mating connector for applicable product and application specifications.

| No. of Pos. | Dimensions | | | | | | | | Part Nos. |
|-------------|---------------|---------------|---------------|---------------|---------------|-------------|---------------|---------------|-----------|
| | A | B | C | D | E | F | G | H | |
| 10 | .612 [15.54] | .532 [13.51] | .400 [10.16] | 1.104 [28.04] | 1.304 [33.12] | .206 [5.23] | — | .632 [16.05] | 87608-1 |
| 12 | .712 [18.08] | .632 [16.05] | .500 [12.70] | 1.204 [30.58] | 1.404 [35.66] | .206 [5.23] | — | .732 [18.59] | 87608-2 |
| 20 | 1.112 [28.24] | 1.032 [26.21] | .900 [22.86] | 1.604 [40.74] | 1.804 [45.82] | .106 [2.69] | .806 [20.47] | 1.132 [28.75] | 87608-6 |
| 24 | 1.312 [33.32] | 1.232 [31.29] | 1.100 [27.94] | 1.804 [45.82] | 2.004 [50.90] | .106 [2.69] | 1.006 [25.55] | 1.332 [33.83] | 87608-8 |
| 26 | 1.412 [35.86] | 1.332 [33.83] | 1.200 [30.48] | 1.904 [48.36] | 2.104 [53.44] | .106 [2.69] | 1.106 [28.09] | 1.432 [36.37] | 87608-9 |
| 34 | 1.812 [46.02] | 1.732 [43.99] | 1.600 [40.64] | 2.304 [58.52] | 2.504 [63.60] | .106 [2.69] | 1.506 [38.25] | 1.832 [46.53] | 1-87608-3 |
| 40 | 2.112 [53.64] | 2.032 [51.61] | 1.900 [48.26] | 2.604 [66.14] | 2.804 [71.22] | .106 [2.69] | 1.806 [45.87] | 2.132 [54.15] | 1-87608-6 |
| 50 | 2.612 [66.34] | 2.532 [64.31] | 2.400 [60.96] | 3.104 [78.84] | 3.304 [83.92] | .106 [2.69] | 2.306 [58.57] | 2.632 [66.85] | 2-87608-1 |
| 60 | 3.112 [79.04] | 3.032 [77.01] | 2.900 [73.66] | 3.604 [91.54] | 3.804 [96.62] | .106 [2.69] | 2.806 [71.27] | 3.132 [79.55] | 2-87608-6 |

Note: All part numbers are RoHS compliant.

Standard Profile Headers—Shrouded Bulkhead Type; with .150 [3.81] End Dimension, Double-Row, .100 x .100 [2.54 x 2.45] Centerline

.025 [0.64] Square Straight Post (with Detent Windows and Mounting Ears)

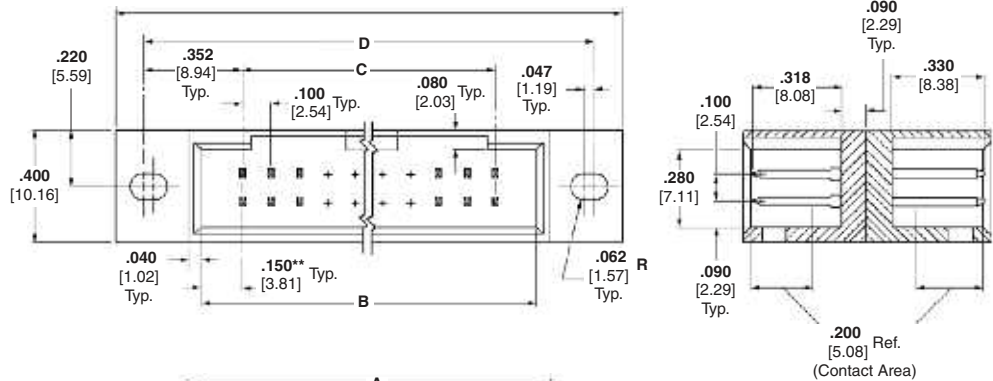

Material and Finish

Housing — Black thermoplastic, 94V-0 rated

Posts — Copper alloy, plated .000030 [0.00076] gold over .000050 [0.00127] nickel on entire post

Related Product Data

Mateable Connectors

AMPMODU MTE Receptacles — pages 232, 233, 235 (used with coupling shroud on page 241)

AMPMODU Wire-Applied Receptacles — pages 216-219

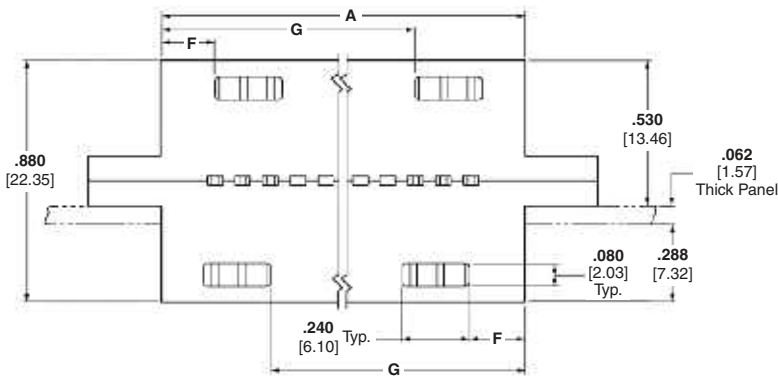

Accessories

Barrier Insert — page 204

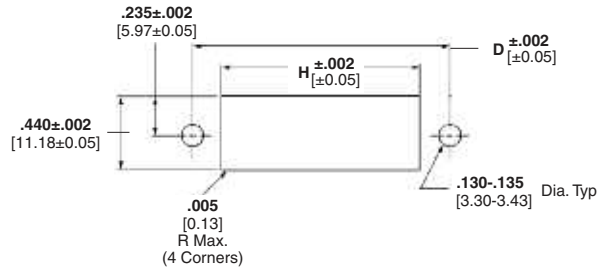

Technical Documents — page 276

See mating connector for applicable product and application specifications.

Recommended Panel Cutout

**Both mating faces have same end dimension.

| No. of Pos. | Dimensions | | | | | | | | Part Nos. |
|-------------|---------------|---------------|---------------|---------------|---------------|-------------|---------------|---------------|-----------|
| | A | B | C | D | E | F | G | H | |
| 10 | .780 [19.81] | .700 [17.78] | .400 [10.16] | 1.104 [28.04] | 1.304 [33.12] | .290 [7.37] | — | .800 [20.32] | 87605-1 |
| 20 | 1.280 [32.51] | 1.200 [30.48] | .900 [22.86] | 1.604 [40.74] | 1.804 [45.82] | .190 [4.83] | .890 [22.61] | 1.300 [33.02] | 87605-6 |
| 24 | 1.480 [37.59] | 1.400 [35.56] | 1.100 [27.94] | 1.804 [45.82] | 2.004 [50.90] | .190 [4.83] | 1.090 [27.69] | 1.500 [38.10] | 87605-8 |
| 26 | 1.580 [40.13] | 1.500 [38.10] | 1.200 [30.48] | 1.904 [48.36] | 2.104 [53.44] | .190 [4.83] | 1.190 [30.23] | 1.600 [40.64] | 87605-9 |
| 30 | 1.780 [45.21] | 1.700 [43.18] | 1.400 [35.56] | 2.104 [53.44] | 2.304 [58.52] | .190 [4.83] | 1.390 [35.31] | 1.800 [45.72] | 1-87605-1 |
| 32 | 1.880 [47.75] | 1.800 [45.72] | 1.500 [38.10] | 2.204 [55.98] | 2.404 [61.06] | .190 [4.83] | 1.490 [37.85] | 1.900 [48.26] | 1-87605-2 |
| 34 | 1.980 [50.29] | 1.900 [48.26] | 1.600 [40.64] | 2.304 [58.52] | 2.504 [63.60] | .190 [4.83] | 1.590 [40.39] | 2.000 [50.80] | 1-87605-3 |
| 40 | 2.280 [57.91] | 2.200 [55.88] | 1.900 [48.26] | 2.604 [66.14] | 2.804 [71.22] | .190 [4.83] | 1.890 [48.01] | 2.300 [58.42] | 1-87605-6 |
| 50 | 2.780 [70.61] | 2.700 [68.58] | 2.400 [60.96] | 3.104 [78.84] | 3.304 [83.92] | .190 [4.83] | 2.390 [60.71] | 2.800 [71.12] | 2-87605-1 |
| 60 | 3.280 [83.31] | 3.200 [81.28] | 2.900 [73.66] | 3.604 [91.54] | 3.804 [96.62] | .190 [4.83] | 2.890 [73.41] | 3.300 [83.82] | 2-87605-6 |

Note: All part numbers are RoHS compliant.

Standard Profile Headers—Shrouded Bulkhead Type; with .066/.150 [1.68/3.81] End Dimension, Double-Row, .100 x .100 [2.54 x 2.45] Centerline

.025 [0.64] Square Straight Post (with Detent Windows and Mounting Ears)

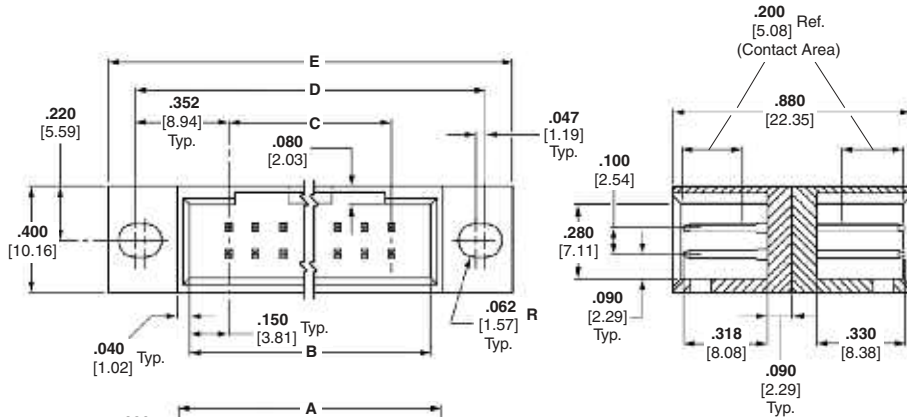

Material and Finish

Housing — Black thermoplastic, 94V-0 rated

Posts — Copper alloy, plated .000030 [0.00076] gold over .000050 [0.00127] nickel on entire post

Related Product Data

Mateable Connectors with .066 [1.68] End Dimension —

AMPMODU Board Mount Receptacles — pages 176, 179, 180

AMPMODU Wire-Applied Receptacles — pages 216-219

AMPMODU MTE Receptacles — pages 228, 229, 234

AMPMODU MT Receptacles — pages 256, 257

Mateable Connectors with .150 [3.81] End Dimension —

AMPMODU MTE Receptacles — pages 232, 233, 235 (used with coupling shroud on page 241)

Accessories

Barrier Insert — page 204

Technical Documents — page 276

See mating connector for applicable product and application specifications.

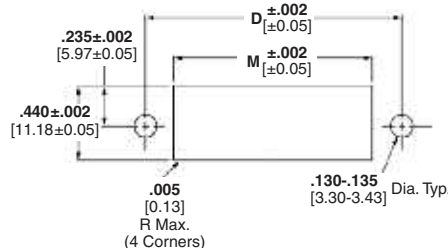
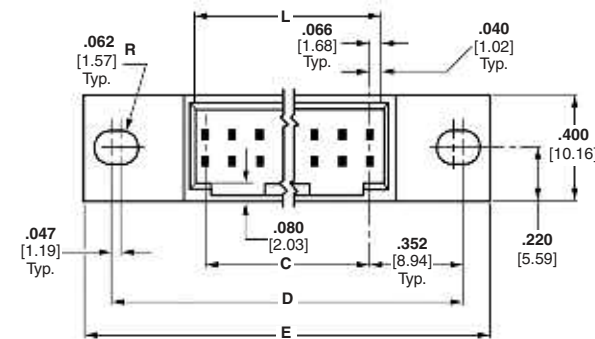
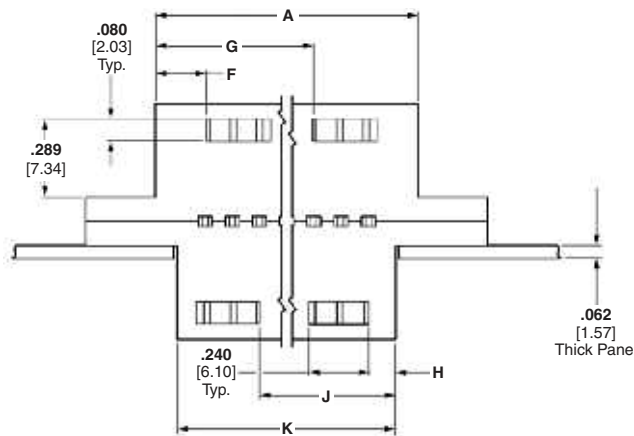

Recommended Panel Cutout

Standard Profile Headers, Shrouded

5

Standard Profile Headers—Shrouded Bulkhead Type; with .066/.150 [1.68/3.81] End Dimension, Double-Row, .100 x .100 [2.54 x 2.45] Centerline (Continued)



| No. of Pos. | Dimensions | | | | | | Part Nos. |
|-------------|---------------|---------------|---------------|---------------|---------------|-------------|-----------|
| | A | B | C | D | E | F | |
| 10 | .780 [19.81] | .700 [17.78] | .400 [10.16] | 1.104 [28.04] | 1.304 [33.12] | .290 [7.37] | 87496-2 |
| 20 | 1.280 [32.51] | 1.200 [30.48] | .900 [22.86] | 1.604 [40.74] | 1.804 [45.82] | .190 [4.83] | 87496-7 |
| 24 | 1.480 [37.59] | 1.400 [35.56] | 1.100 [27.94] | 1.804 [45.82] | 2.004 [50.90] | .190 [4.83] | 87496-9 |
| 26 | 1.580 [40.13] | 1.500 [38.10] | 1.200 [30.48] | 1.904 [48.36] | 2.104 [53.44] | .190 [4.83] | 1-87496-0 |
| 30 | 1.780 [45.21] | 1.700 [43.18] | 1.400 [35.56] | 2.104 [53.44] | 2.304 [58.52] | .190 [4.83] | 1-87496-2 |
| 34 | 1.980 [50.29] | 1.900 [48.26] | 1.600 [40.64] | 2.304 [58.52] | 2.504 [63.60] | .190 [4.83] | 1-87496-4 |
| 40 | 2.280 [57.91] | 2.200 [55.88] | 1.900 [48.26] | 2.604 [66.14] | 2.804 [71.22] | .190 [4.83] | 1-87496-7 |
| 50 | 2.780 [70.61] | 2.700 [68.58] | 2.400 [60.96] | 3.304 [83.92] | 3.304 [83.92] | .190 [4.83] | 87496-1 |
| 60 | 3.280 [83.31] | 3.200 [81.38] | 2.900 [73.66] | 3.604 [91.54] | 3.804 [96.62] | .190 [4.83] | 2-87496-6 |

| No. of Pos. | Dimensions | | | | | | Part Nos. |
|-------------|---------------|-------------|---------------|---------------|---------------|---------------|-----------|
| | G | H | J | K | L | M | |
| 10 | — | .206 [5.23] | — | .612 [15.54] | .532 [13.51] | .632 [16.05] | 87496-2 |
| 20 | .890 [22.61] | .106 [2.69] | .806 [20.47] | 1.112 [28.24] | 1.032 [26.21] | 1.132 [28.75] | 87496-7 |
| 24 | 1.090 [27.69] | .106 [2.69] | 1.006 [25.55] | 1.312 [33.32] | 1.232 [31.29] | 1.332 [33.83] | 87496-9 |
| 26 | 1.190 [30.23] | .106 [2.69] | 1.106 [28.09] | 1.412 [35.86] | 1.332 [33.83] | 1.432 [36.37] | 1-87496-0 |
| 30 | 1.390 [35.31] | .106 [2.69] | 1.306 [33.17] | 1.612 [40.94] | 1.532 [38.91] | 1.632 [41.45] | 1-87496-2 |
| 34 | 1.590 [40.39] | .106 [2.69] | 1.506 [38.25] | 1.812 [46.02] | 1.732 [43.99] | 1.832 [46.53] | 1-87496-4 |
| 40 | 1.890 [48.01] | .106 [2.69] | 1.806 [45.87] | 2.112 [53.64] | 2.032 [51.61] | 2.132 [54.15] | 1-87496-7 |
| 50 | 2.390 [60.71] | .106 [2.69] | 2.306 [58.57] | 2.612 [66.34] | 2.532 [64.31] | 2.632 [66.85] | 87496-1 |
| 60 | 2.890 [73.41] | .106 [2.69] | 2.806 [71.27] | 3.112 [79.04] | 3.032 [77.01] | 3.132 [79.55] | 2-87496-6 |

Note: All part numbers are RoHS compliant.

AMP-LATCH Low Profile Headers—Shrouded

Product Facts

- Available in selected positions 10 thru 60
- Flame retardant, thermoplastic housings, 94V-0 rated
- Vertical and right-angle versions available in double row configurations
- Available in .025 [0.64] square drawn wire posts
- Wash out clearance for flux removal
- Mates with AMP-LATCH Ribbon Cable Connectors
- Available with and without eject latches
- Available with and without kinked soldertails for PCB retention
- Recognized under the Component Program of Underwriters Laboratories Inc.  File No. E28476
- Certified by Canadian Standards Association,  File No. LR 7189

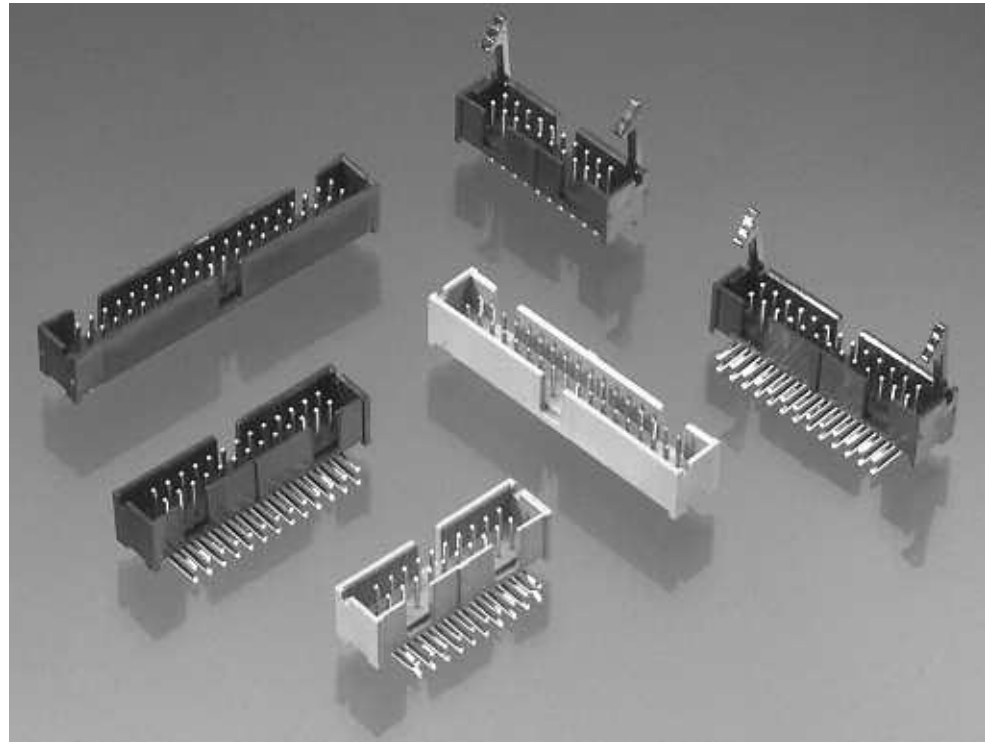

Performance Characteristics

Electrical

Insulation Resistance — 5,000 megohms minimum initial

Dielectric Withstanding Voltage — 1,000 V rms at sea level

Environmental

Operating Temperature — -65°C to +105°C

Current — 1 ampere maximum per contact

AMP-LATCH Low Profile Headers—Shrouded, with .150 [3.81] End Dimension, Double-Row, .100 x .100 [2.54 x 2.54] Centerline

.025 [0.64] Square Straight Post

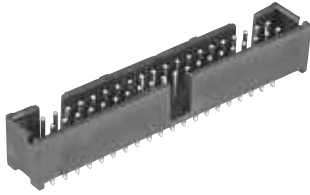

Material and Finish

Housing — Glass-filled nylon, black, 94V-0 rated

Posts — Copper alloy, plated as follows:

Plating A — Gold flash over .000030 [0.00076] min. palladium-nickel plate on the mating surfaces, .000100 [0.00254] min. tin plate on soldertails, with entire post underplated .000050 [0.00127] min. nickel

Plating B — Gold flash over .000015 [0.00038] min. palladium-nickel plate on the mating surfaces, .000100 [0.00254] min. tin plate on soldertails, with entire post underplated .000050 [0.00127] min. nickel

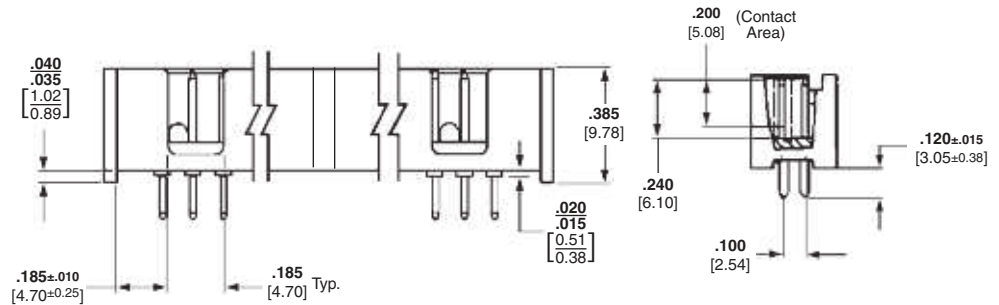
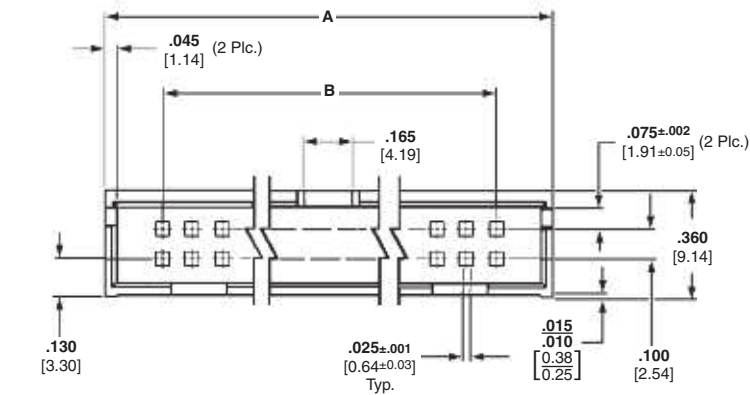

Related Product Data

Electrical Characteristics — page 134

Mateable Connectors —

AMPMODU Wire-Applied Receptacles — page 220

AMPMODU Board Mount Receptacles — pages 179, 180

Short Point Wire-Applied Connectors — page 224

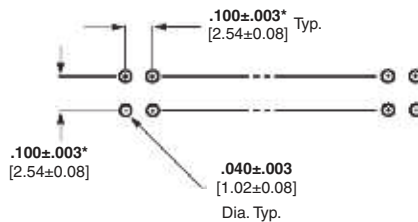

Recommended PC Board Hole Layout For Manual Insertion

*±.003 [±0.08] tolerances not to accumulate within one connector pattern.

| No. of Pos. | Dimensions | | Post Plating/Part Nos. | |
|-------------|---------------|---------------|------------------------|-------------|
| | A | B | Plating A | Plating B |
| 10 | .800 [20.32] | .400 [10.16] | 5103309-1 | 5103308-1 |
| 14 | 1.000 [25.40] | .600 [15.24] | 5103309-2 | 5103308-2 |
| 16 | 1.100 [27.94] | .700 [17.78] | 5103309-3 | 5103308-3 |
| 20 | 1.300 [33.02] | .900 [22.86] | 5103309-5 | 5103308-5 |
| 24 | 1.400 [35.56] | 1.100 [27.94] | — | 1-5103308-3 |
| 26 | 1.600 [40.64] | 1.200 [30.48] | 5103309-6 | 5103308-6 |
| 34 | 2.000 [50.80] | 1.600 [40.64] | 5103309-7 | 5103308-7 |
| 40 | 2.300 [58.42] | 1.900 [48.26] | 5103309-8 | 5103308-8 |
| 50 | 2.800 [71.12] | 2.400 [60.96] | 1-5103309-0 | 1-5103308-0 |
| 60 | 3.300 [83.82] | 2.900 [73.66] | — | 1-5103308-2 |

Note: All part numbers are RoHS compliant.

AMP-LATCH Low Profile Headers—Shrouded, with .150 [3.81] End Dimension, Double-Row, .100 x .100 [2.54 x 2.54] Centerline (Continued)

.025 [0.64] Square Right-Angle Post

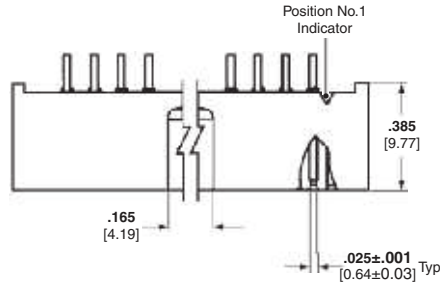
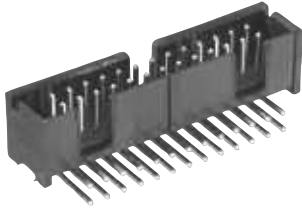

Material and Finish

Housing — Glass-filled nylon, black, 94V-0 rated

Posts — Copper alloy, plated as follows:

Plating A — Gold flash over .000030 [0.00076] min. palladium-nickel plate on the mating surfaces, .000100 [0.00254] min. tin plate on soldertails, with entire post underplated .000050 [0.00127] min. nickel

Plating B — Gold flash over .000015 [0.00038] min. palladium-nickel plate on the mating surfaces, .000100 [0.00254] min. tin plate on soldertails, with entire post underplated .000050 [0.00127] min. nickel

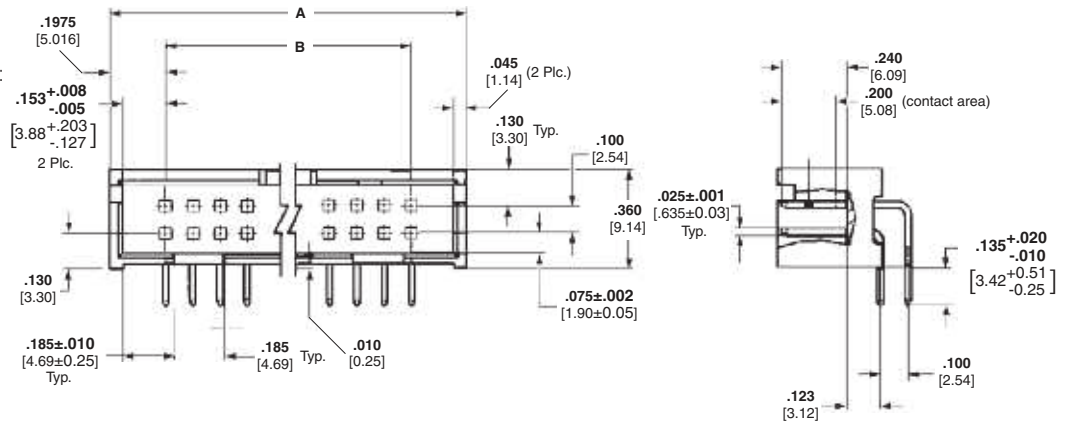

Related Product Data

Electrical Characteristics — page 134

Mateable Connectors — AMPMODU Wire-Applied Receptacles — page 220

Short Point Wire-Applied Connectors — page 224

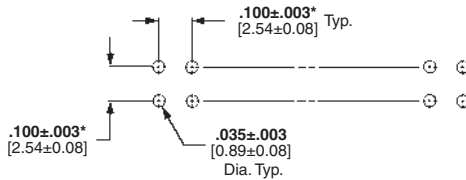

Recommended PC Board Hole Layout For Manual Insertion

*±.003 [±0.08] tolerances not to accumulate within one connector pattern.

| No. of Pos. | Dimensions | | Post Plating/Part Nos. | |
|-------------|---------------|---------------|------------------------|-------------|
| | A | B | Plating A | Plating B |
| 10 | .800 [20.32] | .400 [10.16] | 5103311-1 | 5103310-1 |
| 14 | 1.000 [25.40] | .600 [15.24] | 5103311-2 | 5103310-2 |
| 16 | 1.100 [27.94] | .700 [17.78] | 5103311-3 | 5103310-3 |
| 20 | 1.300 [33.02] | .900 [22.86] | 5103311-5 | 5103310-5 |
| 26 | 1.600 [40.64] | 1.200 [30.48] | 5103311-6 | 5103310-6 |
| 34 | 2.000 [50.80] | 1.600 [40.64] | 5103311-7 | 5103310-7 |
| 40 | 2.300 [58.42] | 1.900 [48.26] | 5103311-8 | 5103310-8 |
| 50 | 2.800 [71.12] | 2.400 [60.96] | 1-5103311-0 | 1-5103310-0 |
| 60 | 3.300 [83.82] | 2.900 [73.66] | 1-5103311-2 | — |

Note: All part numbers are RoHS compliant.

AMP-LATCH Low Profile Headers—Shrouded, with .150 [3.81] End Dimension, Double-Row, .100 x .100 [2.54 x 2.54] Centerline & “Kinked” Solderetails for PCB Retention

.025 [0.64] Square Straight Post (with Board Retention Feature)

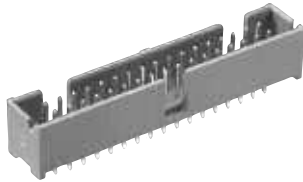

Material and Finish

Housing — Glass-filled PPA, black, 94V-0 rated

Posts — Copper alloy, plated with gold flash over .000015 [0.00038] min. palladium-nickel plate on the mating surfaces, .000100 [0.00254] min. tin plate on solderetails, with entire post underplated .000050 [0.00127] min. nickel

Related Product Data

Electrical Characteristics — page 134

Mateable Connectors —

AMPMODU Wire-Applied Receptacles — page 220

AMPMODU Board Mount Receptacles — pages 179, 180

Short Point Wire-Applied Connectors — page 224

*Reflow solder process compatible

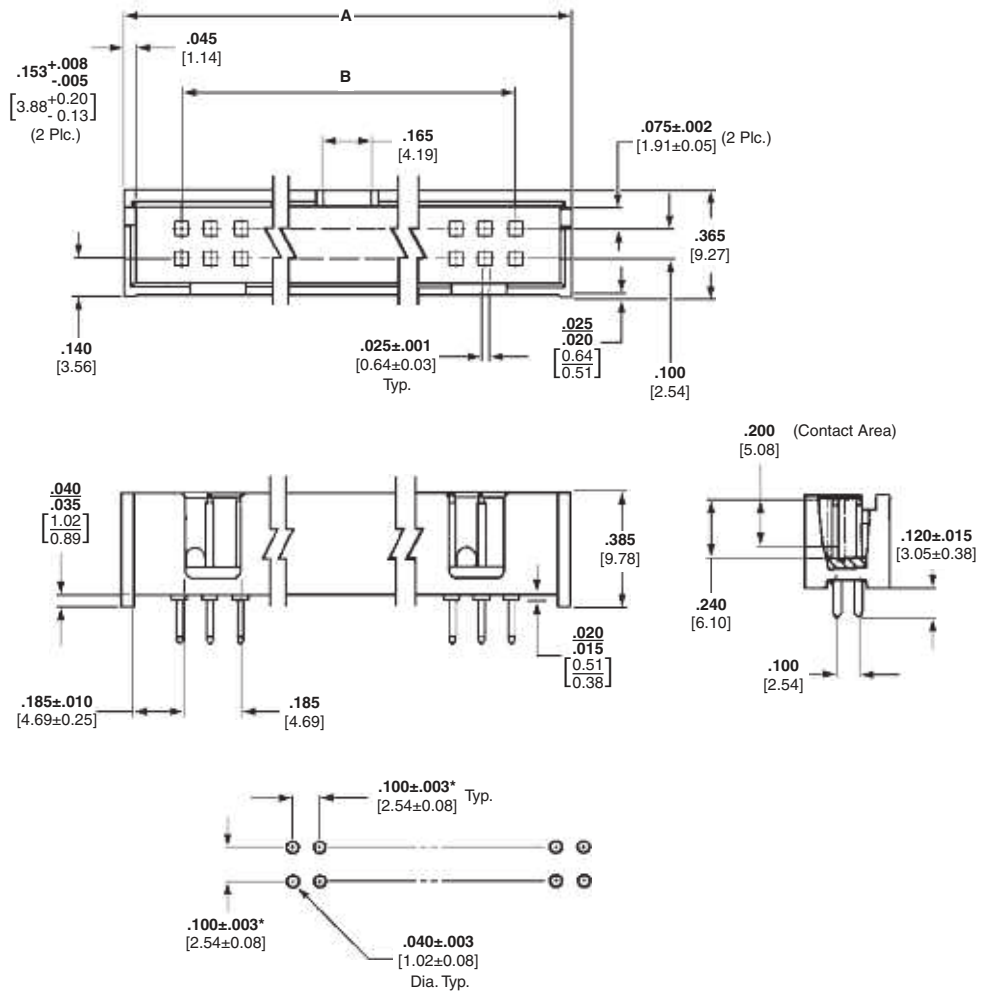

Recommended PC Board Hole Layout For Manual Insertion

*±.003 [±0.08] tolerances not to accumulate within one connector pattern.

| No. of Pos. | Dimensions | | Post Plating Part Nos. |
|-------------|---------------|---------------|------------------------|
| | A | B | |
| 10 | .800 [20.32] | .400 [10.16] | 5104338-1 |
| 14 | 1.000 [25.40] | .600 [15.24] | 5104338-2 |
| 16 | 1.100 [27.94] | .700 [17.78] | 5104338-3 |
| 20 | 1.300 [33.02] | .900 [22.86] | 5104338-4 |
| 24 | 1.400 [35.56] | 1.100 [27.94] | 5104338-5 |
| 34 | 2.000 [50.80] | 1.600 [40.64] | 5104338-7 |
| 40 | 2.300 [58.42] | 1.900 [48.26] | 5104338-8 |
| 50 | 2.800 [71.12] | 2.400 [60.96] | 5104338-9 |
| 60 | 3.300 [83.82] | 2.900 [73.66] | 1-5104338-0 |

Note: All part numbers are RoHS compliant.

AMP-LATCH Low Profile Headers—Shrouded, with .150 [3.81] End Dimension, Double-Row, .100 x .100 [2.54 x 2.54] Centerline & “Kinked” Solderetails for PCB Retention (Continued)

.025 [0.64] Square Right-Angle Post (with Board Retention Feature)

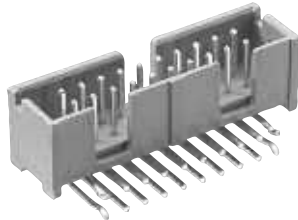

Material and Finish

Housing — Glass-filled PPA, black, 94V-0 rated

Posts — Copper alloy, plated with gold flash over .000015 [0.00038] min. palladium-nickel plate on the mating surfaces, .000100 [0.00254] min. tin plate on solderetails, with entire post underplated .000050 [0.00127] min. nickel

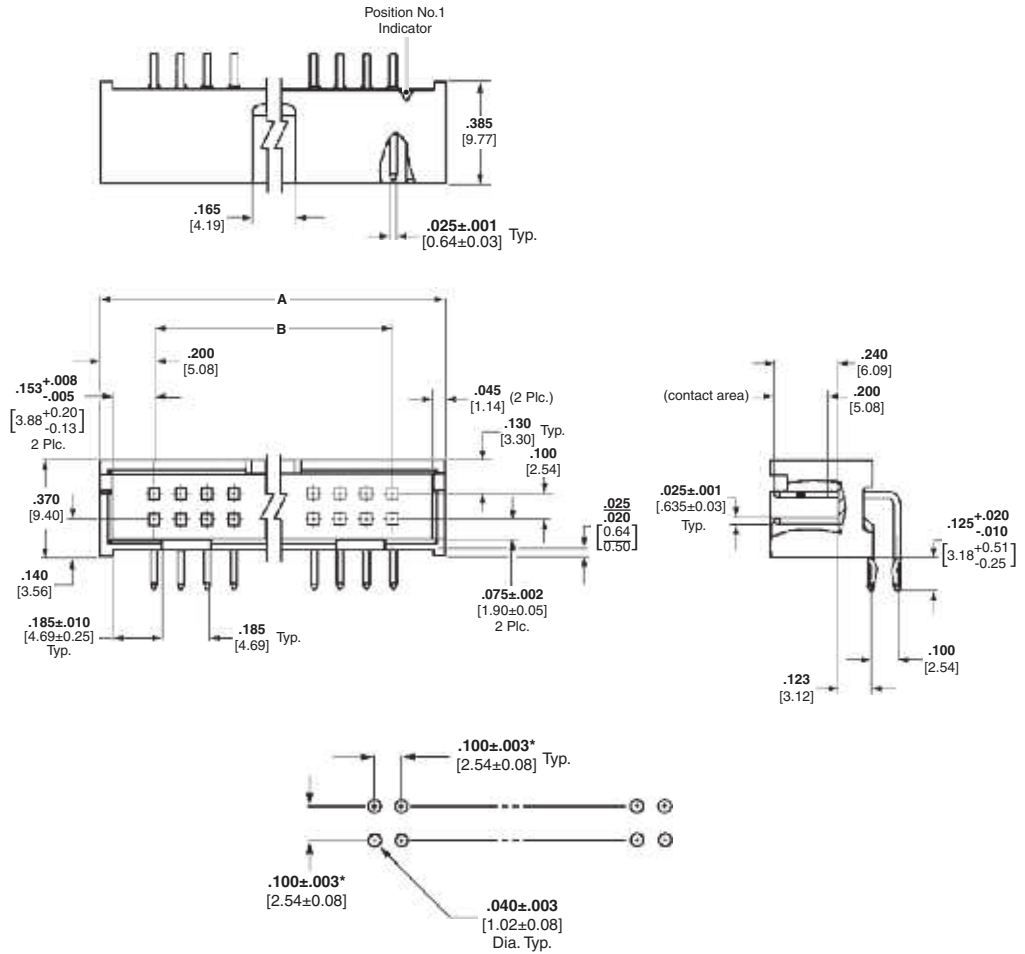

Recommended PC Board Hole Layout For Manual Insertion

*±.003 [±0.08] tolerances not to accumulate within one connector pattern.

Related Product Data

Electrical Characteristics — page 134

Mateable Connectors —

AMPMODU Wire-Applied Receptacles — page 220

Short Point Wire-Applied Connectors — page 224

Low Profile Headers, Shrouded

5

| No. of Pos. | Dimensions | | Post Plating Part Nos. |
|-------------|---------------|---------------|------------------------|
| | A | B | |
| 10 | .800 [20.32] | .400 [10.16] | 5104340-1 |
| 14 | 1.000 [25.40] | .600 [15.24] | 5104340-2 |
| 16 | 1.100 [27.94] | .700 [17.78] | 5104340-3 |
| 20 | 1.300 [33.02] | .900 [22.86] | 5104340-4 |
| 40 | 2.300 [58.42] | 1.900 [48.26] | 5104340-8 |
| 50 | 2.800 [71.12] | 2.400 [60.96] | 5104340-9 |

Note: All part numbers are RoHS compliant.

Universal Ejection Style Pin Headers, Military, Center and Dual Polarized, .100 x .100 [2.54 x 2.54] Centers

Straight-Thru, 4-Sided .025 [0.64] Sq. Posts



Pin Header with Latches



Pin Header without Latches

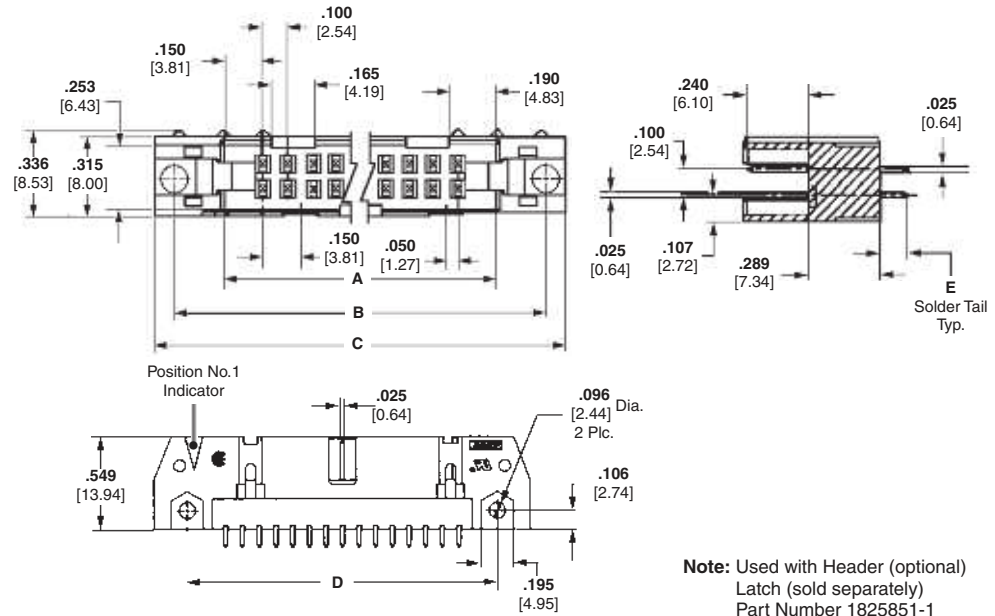

Note: Used with Header (optional) Latch (sold separately) Part Number 1825851-1

Material and Finish

Housing & Latches — Black thermoplastic, 94V-0 rated

Contacts — Brass or phosphor bronze (at TE's option); Duplex .000030 [0.00076] gold on mating end, .000100 [0.00254] min. tin on termination end, with entire contact underplated .000050 [0.00127] nickel

Related Product Data

Electrical Characteristics — page 134

Mateable Connectors — AMPMODU Wire-Applied Receptacles — page 220

Mounting Information

4-24 self-tapping screws and 2-56 bolts and nuts are available for mounting straight-thru pin headers of pc boards. Typical applications and part nos. for ordering this hardware are presented below.

Note: 2-56 bolts and nuts may be used to mount pin headers with and without latches. If latches are to be used, the bolts must be positioned in the pin header before the latches are installed.

Note: All part numbers are RoHS compliant.

| No. of Positions | Dimensions | | | | | Part Number (Without Latches) |
|------------------|------------|-------|-------|-------|-------------|-------------------------------|
| | A | B | C | D | E | |
| 10 | .700 | 1.100 | 1.260 | .860 | .110 [2.79] | 5102154-1 |
| | 17.78 | 27.94 | 32.00 | 21.84 | .155 [3.94] | 5102156-1 |
| 14 | .900 | 1.300 | 1.460 | 1.060 | .110 [2.79] | 5102154-2 |
| | 22.86 | 33.02 | 37.08 | 26.92 | .155 [3.94] | 5102156-2 |
| 16 | 1.000 | 1.400 | 1.560 | 1.180 | .110 [2.79] | 5102154-3 |
| | 25.40 | 35.56 | 39.62 | 29.46 | .155 [3.94] | 5102156-3 |
| 20 | 1.200 | 1.600 | 1.760 | 1.360 | .110 [2.79] | 5102154-4 |
| | 30.48 | 40.64 | 44.70 | 34.54 | .155 [3.94] | 5102156-4 |
| 24 | 1.400 | 1.800 | 1.960 | 1.560 | .110 [2.79] | 5102154-5 |
| | 35.56 | 45.72 | 49.78 | 39.62 | .155 [3.94] | 5102156-5 |
| 26 | 1.500 | 1.900 | 2.060 | 1.660 | .110 [2.79] | 5102154-6 |
| | 38.10 | 48.26 | 52.32 | 42.16 | .155 [3.94] | 5102156-6 |
| 34 | 1.900 | 2.300 | 2.460 | 2.060 | .110 [2.79] | 5102154-8 |
| | 48.26 | 58.42 | 62.48 | 52.32 | .155 [3.94] | 5102156-8 |
| 40 | 2.200 | 2.600 | 2.760 | 2.360 | .110 [2.79] | 5102154-9 |
| | 55.88 | 66.04 | 70.10 | 59.94 | .155 [3.94] | 5102156-9 |
| 50 | 2.700 | 3.100 | 3.260 | 2.860 | .110 [2.79] | 1-5102154-0 |
| | 68.58 | 78.74 | 82.80 | 72.64 | .155 [3.94] | 1-5102156-0 |

- Notes: 1. Pin headers in 10- and 14-position sizes have only one slot for snap-in polarizer (military polarization), located as shown.
2. Pin headers in 10-position size have only slot for dual polarization, located as shown.

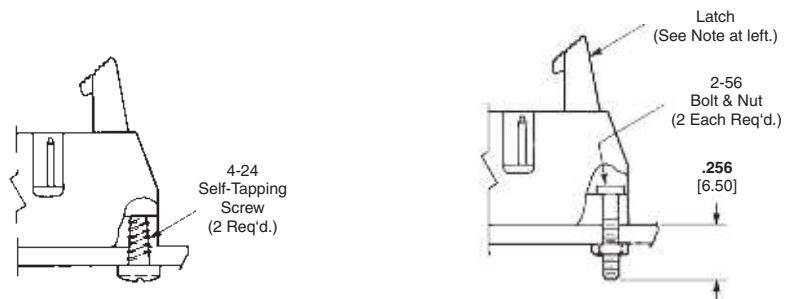

Pin Header Mounting using 4-24 Self-Tapping Screws:
Part No. 19156-1 (for .062 [1.57] Thick PC Board)
19156-2 (for .093 [2.36] Thick PC Board)
19156-3 (for .125 [3.18] Thick PC Board)

Pin Header Mounting with 2-56 Bolts and Nuts:
Part No. 746383-1 (Bolt Only)
Kit No. 102198-1 (Bolt and Nut, 2 Each per Kit)

Universal Ejection Style Pin Headers, Military, Center and Dual Polarized, .100 x .100 [2.54 x 2.54] Centers (Continued)

Right-Angle, 4-Sided .025 [0.64] Sq. Posts



Pin Header with Latches



Pin Header without Latches

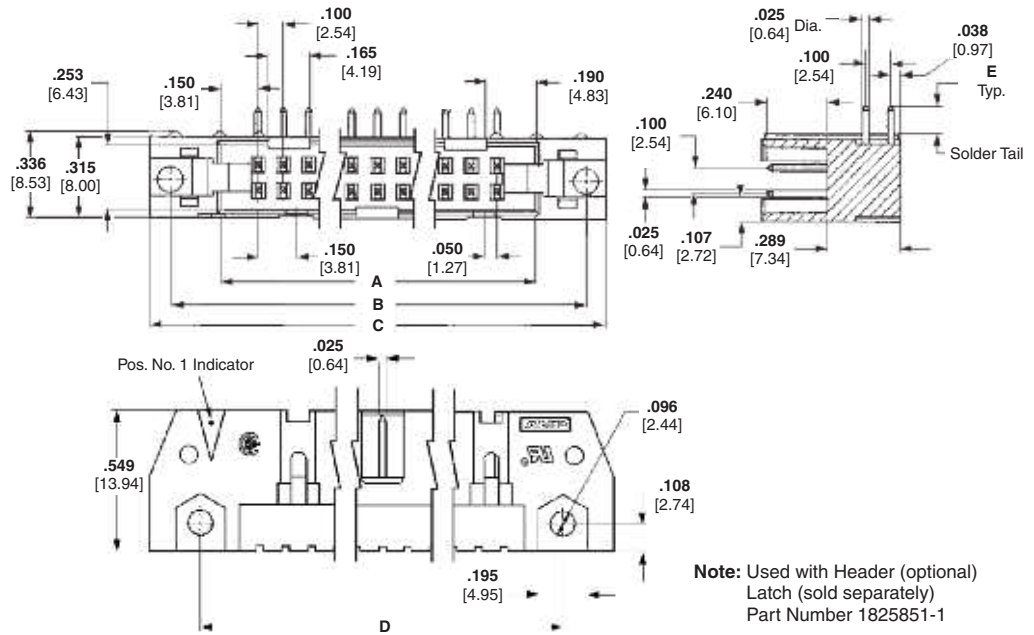

| No. of Positions | Dimensions | | | | | Part Number (Without Latches) |
|------------------|------------|-------|-------|-------|-------------|-------------------------------|
| | A | B | C | D | E | |
| 10 | .700 | 1.100 | 1.260 | .860 | .110 [2.79] | 5102160-1 |
| | 17.78 | 27.94 | 32.00 | 21.84 | .155 [3.94] | 5102162-1 |
| 14 | .900 | 1.300 | 1.460 | 1.060 | .110 [2.79] | 2-5102160-2* |
| | 22.86 | 33.02 | 37.08 | 26.92 | .155 [3.94] | 2-5102162-2* |
| 16 | 1.000 | 1.400 | 1.560 | 1.180 | .110 [2.79] | 5102160-3 |
| | 25.40 | 35.56 | 39.62 | 29.46 | .155 [3.94] | — |
| 20 | 1.200 | 1.600 | 1.760 | 1.360 | .110 [2.79] | 5102160-4 |
| | 30.48 | 40.64 | 44.70 | 34.54 | .155 [3.94] | — |
| 24 | 1.400 | 1.800 | 1.960 | 1.560 | .110 [2.79] | 5102160-5 |
| | 35.56 | 45.72 | 49.78 | 39.62 | .155 [3.94] | — |
| 26 | 1.500 | 1.900 | 2.060 | 1.660 | .110 [2.79] | 5102160-6 |
| | 38.10 | 48.26 | 52.32 | 42.16 | .155 [3.94] | 2-5102162-6* |
| 34 | 1.900 | 2.300 | 2.460 | 2.060 | .110 [2.79] | 5102160-8 |
| | 48.26 | 58.42 | 62.48 | 52.32 | .155 [3.94] | 5102162-8 |
| 40 | 2.200 | 2.600 | 2.760 | 2.360 | .110 [2.79] | 5102160-9 |
| | 55.88 | 66.04 | 70.10 | 59.94 | .155 [3.94] | — |
| 50 | 2.700 | 3.100 | 3.260 | 2.860 | .110 [2.79] | 1-5102160-0 |
| | 68.58 | 78.74 | 82.80 | 72.64 | .155 [3.94] | 1-5102162-0 |

Material and Finish

Housing & Latches — Black thermoplastic, 94V-0 rated

Contacts — Brass or phosphor bronze (at TE's option); Duplex .000030 [0.00076] gold on mating end, .000100 [0.00254] min. tin on termination end, with entire contact underplated .000050 [0.00127] nickel

Related Product Data

Electrical Characteristics — page 134

Mateable Connectors — AMPMODU Wire-Applied Receptacles — page 220

Mounting Information

4-24 self-tapping screws and 2-56 bolts and nuts are available for mounting straight-thru pin headers of pc boards. Typical applications and part nos. for ordering this hardware are presented below.

Note: 2-56 bolts and nuts may be used to mount pin headers with and without latches. If latches are to be used, the bolts must be positioned in the pin header before the latches are installed.

Note: All part numbers are RoHS compliant.

- Notes:** 1. Pin headers in 10- and 14-position sizes have only one slot for snap-in polarizer (military polarization), located as shown.
2. Pin headers in 10-position size have only slot for dual polarization, located as shown.
*Blue housing.

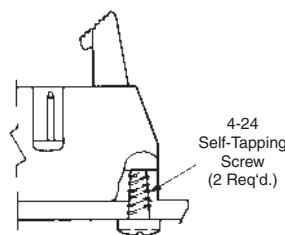

Pin Header Mounting using 4-24 Self-Tapping Screws:
Part No. 19156-1 (for .062 [1.57] Thick PC Board)
19156-2 (for .093 [2.36] Thick PC Board)
19156-3 (for .125 [3.18] Thick PC Board)

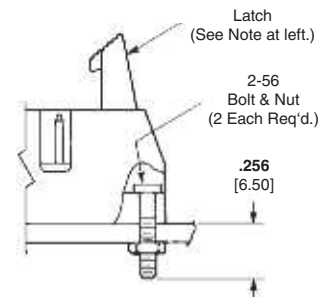

Pin Header Mounting with 2-56 Bolts and Nuts:
Part No. 746383-1 (Bolt Only)
Kit No. 102198-1 (Bolt and Nut, 2 Each per Kit)

AMPMODU Stacking Connectors—Shrouded, .025 x .025 [0.64 x 0.64] Posts

Product Facts

- Parallel PC board stacking without use of mother boards
- Provides space between boards for interference-free routing of wire-to-board connections
- Two header heights available: .785 [19.94] and 1.200 [30.48]
- Vertical mount headers are fully shrouded
- Receptacle contacts have dual cantilever beams with built-in overstress protection
- .025 [0.64] sq. posts and receptacle contacts on double-row, .100 x .100 [2.54 x 2.54] centers
- Header posts and receptacle contacts are phosphor bronze, duplex plated
- Housings are made of flame retardant, glass-filled thermoplastic



AMPMODU stacking connectors are a two-piece interconnection system designed for parallel stacking printed circuit boards, without the use of mother boards.

Vertical mount headers and receptacle assemblies feature duplex plated posts and receptacle contacts on a double-row, .100 x .100 [2.54 x 2.54] grid. The .025 [0.64] sq. header posts are more protected, and the top-entry receptacle contacts utilize the proven

AMPMODU receptacle contact design; dual cantilever beams with built-in overstress protection.

Headers are available in two heights: .785 [19.94] and 1.200 [30.48]. This allows the customer to use the height of the header to keep wire-to-board connections up and away from other board components, particularly if the components are densely packaged around the header.

Receptacle Assemblies, Double-Row Board Mounted

Vertical Mount, Top Entry, High Profile, Selectively Loaded (with Standoffs)

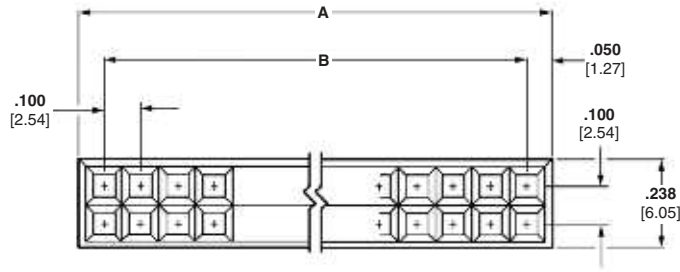

Material and Finish

Housing — Glass-filled thermoplastic, black, 94V-0 rated

Contacts — Phosphor bronze, plated .000010 [0.000254] min. gold on mating area, .000150-.000300 [0.00381-0.00762] matte tin on solder area, with entire contact underplated .000050-.000100 [0.00127-0.00254] nickel

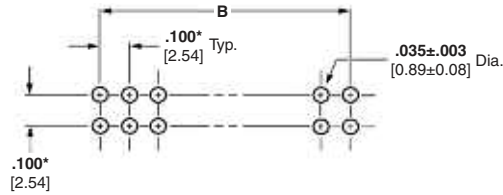
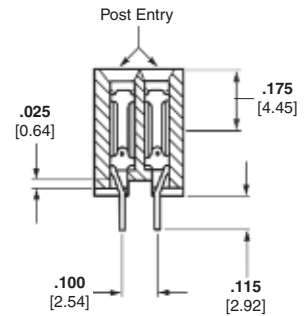
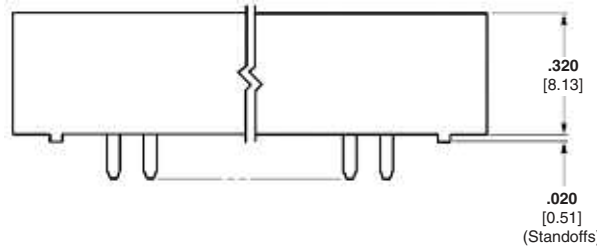

Recommended PC Board Hole Layout

*±.003 [±0.08] tolerances not to accumulate within one connector pattern.

| No. of Pos. | Dimensions | | Receptacle Assembly Part No. |
|--------------------|---------------|---------------|------------------------------|
| | A | B | |
| 48* (40 Active) | 2.400 [60.96] | 2.300 [58.42] | 5-102766-1 |
| 60* (52 Active) | 3.000 [76.2] | 2.900 [73.66] | 5-102766-4 |

*In addition to the *active* positions, each receptacle has four cavities on each end that are not loaded with contacts. These empty cavities aid in aligning the receptacle with header posts during mating.

- Notes:**
1. Part no. and date code stamped on housing where size permits.
 2. These receptacle assemblies mate with headers of the same size as the *active* positions listed above. Refer to pages 143 and 144.

Note: All part numbers are RoHS compliant.

Headers, Double-Row, .785 [19.94] Height

**.025 x .025 [0.64 x 0.64]
Straight Post (with
Pin Protection)**

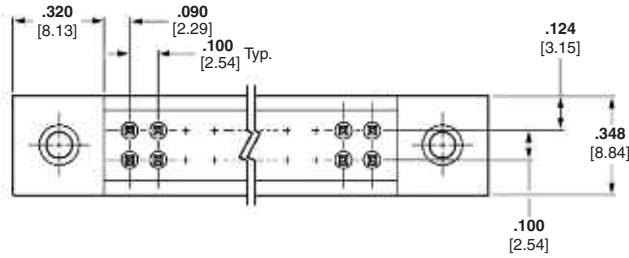
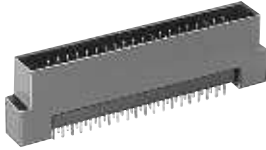

Material and Finish

Housing — Glass-filled thermoplastic, black, 94V-0 rated

Contacts — Phosphor bronze, plated .000015 [0.000381] min. gold on mating area, .000100-.000200 [0.00254-.00508] matte tin on solder area, with entire post underplated .000050 [0.00127] nickel

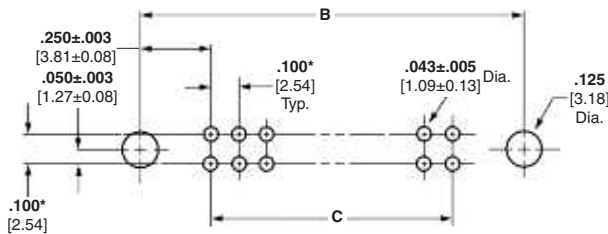
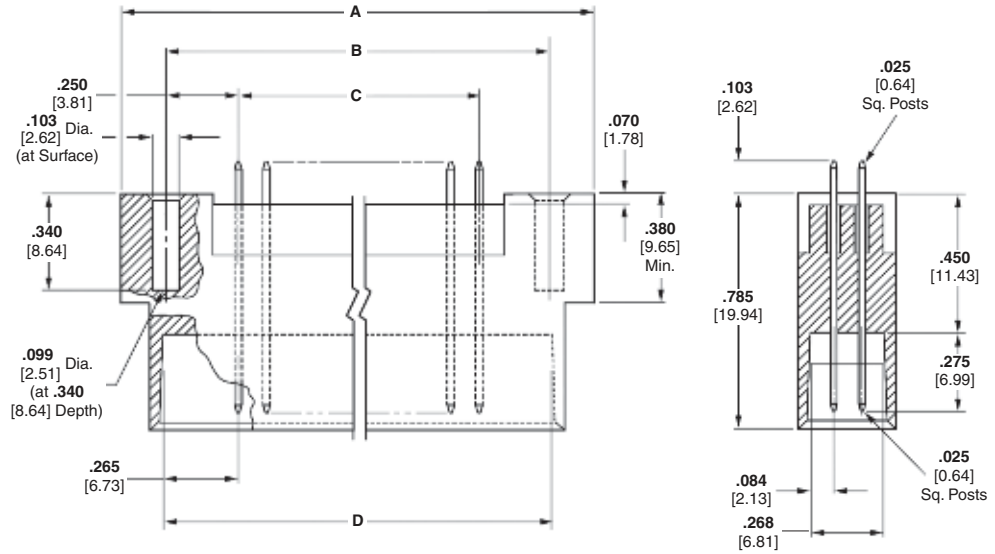

Recommended PC Board Hole Layout

*±.003 [±0.08] tolerances not to accumulate within one connector pattern.

| No. of Pos. | Dimensions | | | | Header Part No. |
|-------------|---------------|---------------|---------------|---------------|-----------------|
| | A | B | C | D | |
| 40 | 2.720 [69.09] | 2.400 [60.96] | 1.900 [48.26] | 2.430 [61.27] | 5-102871-2 |
| 52 | 3.320 [84.33] | 3.000 [76.2] | 2.500 [63.5] | 3.030 [76.96] | 5-102871-1 |

Note: These headers mate with receptacle assemblies having the same number of active positions. See page 142.

Note: All part numbers are RoHS compliant.

Headers, Double-Row, 1.200 [30.48] Height

**.025 x .025 [0.64 x 0.64]
Straight Post (with
Pin Protection)**

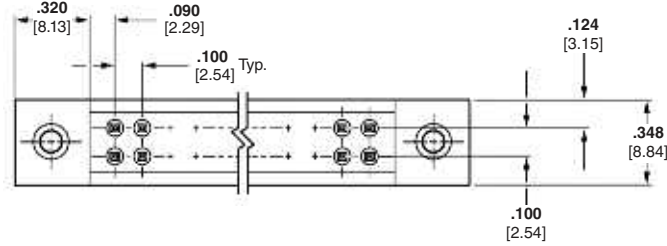

Material and Finish

Housing — Glass-filled thermoplastic, black, 94V-0 rated

Contacts — Phosphor bronze, plated .000015 [0.000381] min. gold on mating area, .000100-.000200 [0.00254-0.00508] matte tin on solder area, with entire post underplated .000050 [0.00127] nickel

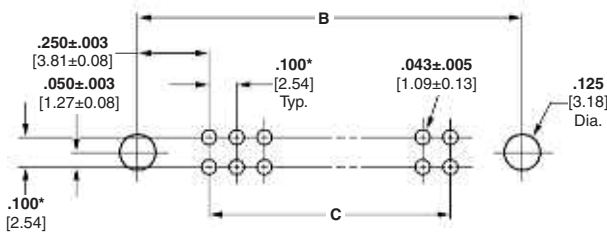
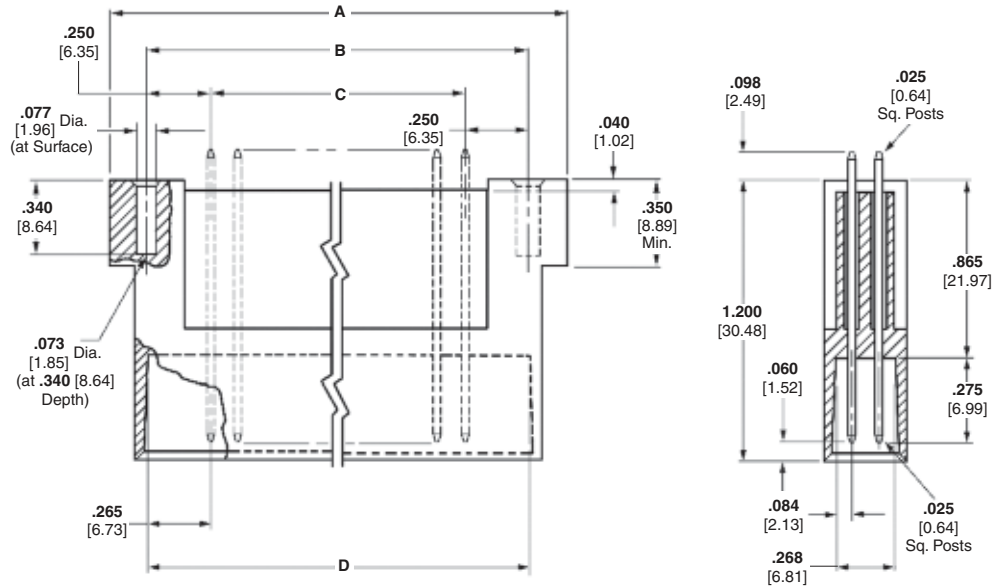

Recommended PC Board Hole Layout

*±.003 [±0.08] tolerances not to accumulate within one connector pattern.



| No. of Pos. | Dimensions | | | | Header Part No. |
|-------------|---------------|--------------|--------------|---------------|-----------------|
| | A | B | C | D | |
| 52 | 3.320 [84.33] | 3.000 [76.2] | 2.500 [63.5] | 3.030 [76.96] | 5-102826-1 |

Note: This header mates with receptacle assembly having the same number of active positions. See page 142.

Note: All part numbers are RoHS compliant.

ACTION PIN Headers—Shrouded and Unshrouded

Product Facts

- Straight posted unshrouded and shrouded versions
- .025 [0.64] square ACTION PIN posts
- ACTION PIN posts make a gas-tight, press-fit connection in plated-through holes
- Designed not to damage plated-through holes
- Unshrouded headers available in selected sizes 1 through 40 positions (single-row) and 4 through 80 positions (double-row)
- Shrouded headers (double-row) available in selected sizes of 6 through 60 positions
- Flame retardant, black thermoplastic housings, 94V-0 rated
- .100 [2.54] Centerline spacing
- Recognized under the Component Program of Underwriters Laboratories Inc.,  File No. E28476
- Certified by Canadian Standards Association,  File No. LR 16455

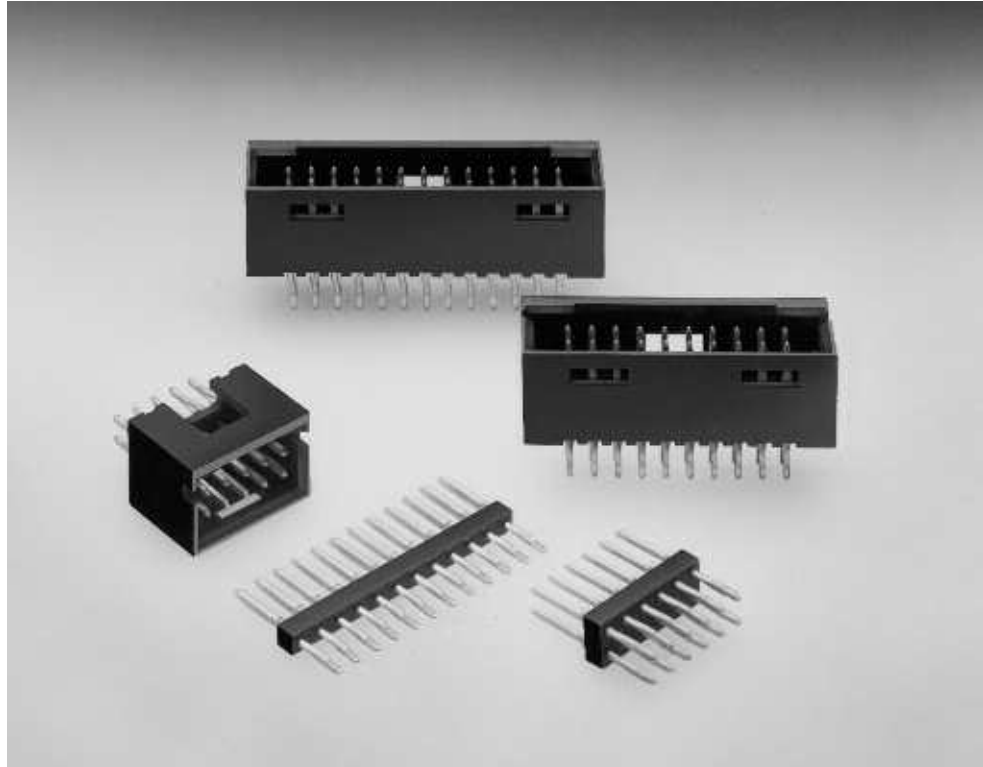

ACTION PIN Headers—Unshrouded, Single-Row, .100 [2.54] Centerline

.025 [0.64] Square Straight Post

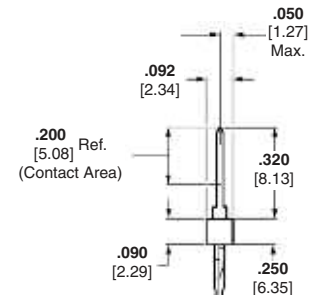
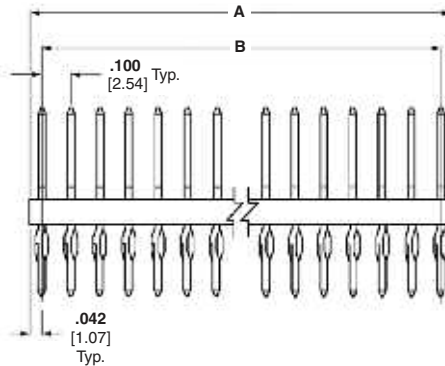

Material and Finish

Housing — Black thermoplastic, 94V-0 rated

Posts — Copper alloy, duplex plated .000030 [0.00076] gold on contact area, .000100-.000200 [0.00254-0.00508] matte tin on termination end, with entire post underplated .000050 [0.00127] nickel

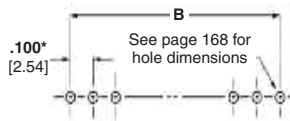

Recommended PC Board Hole Layout

*±.003 [±0.08] tolerances not to accumulate within one connector pattern.

Related Product Data

Mateable Connectors —

Refer to the Mating Post Selection Guide — page 90

ACTION PIN Posts — pages 150, 151

Application Tooling — page 152

Technical Documents — page 276

See mating connector for applicable product and application specifications

| No. of Pos. | Dimensions | | Part Nos. | |
|-------------|----------------|---------------|---------------------------------|---|
| | A | B | For .062 [1.57] Thick PC Boards | For .093-.125 [2.36-3.18] Thick PC Boards |
| 1 | .084 [2.13] | — | 8-103336-5 | 8-102898-5 |
| 2 | .184 [4.67] | .100 [2.54] | 8-103336-4 | 8-102898-4 |
| 3 | .284 [7.21] | .200 [5.08] | 9-103336-0 | 9-102898-0 |
| 4 | .384 [9.75] | .300 [7.62] | 8-103336-6 | 8-102898-6 |
| 5 | .484 [12.29] | .400 [10.16] | 8-103336-8 | 8-102898-8 |
| 6 | .584 [14.83] | .500 [12.70] | 8-103336-7 | 8-102898-7 |
| 7 | .684 [17.37] | .600 [15.24] | 8-103336-9 | 8-102898-9 |
| 8 | .784 [19.91] | .700 [17.78] | 5-103336-1 | 5-102898-1 |
| 9 | .884 [22.45] | .800 [20.32] | 5-103336-2 | 5-102898-2 |
| 10 | .984 [24.99] | .900 [22.86] | 5-103336-3 | 5-102898-3 |
| 11 | 1.084 [27.53] | 1.000 [25.40] | 5-103336-4 | 5-102898-4 |
| 12 | 1.184 [30.07] | 1.100 [27.94] | 5-103336-5 | 5-102898-5 |
| 13 | 1.284 [32.61] | 1.200 [30.48] | 5-103336-6 | 5-102898-6 |
| 14 | 1.384 [35.15] | 1.300 [33.02] | 5-103336-7 | 5-102898-7 |
| 15 | 1.484 [37.69] | 1.400 [35.56] | 5-103336-8 | 5-102898-8 |
| 16 | 1.584 [40.23] | 1.500 [38.10] | 5-103336-9 | 5-102898-9 |
| 17 | 1.684 [42.77] | 1.600 [40.64] | 6-103336-0 | 6-102898-0 |
| 18 | 1.784 [45.31] | 1.700 [43.18] | 6-103336-1 | 6-102898-1 |
| 19 | 1.884 [47.85] | 1.800 [45.72] | 6-103336-2 | 6-102898-2 |
| 20 | 1.984 [50.39] | 1.900 [48.26] | 6-103336-3 | 6-102898-3 |
| 21 | 2.084 [52.93] | 2.000 [50.80] | — | 6-102898-4 |
| 22 | 2.184 [55.47] | 2.100 [53.34] | — | 6-102898-5 |
| 23 | 2.284 [58.01] | 2.200 [55.88] | — | 6-102898-6 |
| 24 | 2.384 [60.55] | 2.300 [58.42] | — | 6-102898-7 |
| 25 | 2.484 [63.09] | 2.400 [60.96] | 6-103336-8 | 6-102898-8 |
| 26 | 2.584 [65.63] | 2.500 [63.50] | — | 6-102898-9 |
| 27 | 2.684 [68.17] | 2.600 [66.04] | — | 7-102898-0 |
| 28 | 2.784 [70.71] | 2.700 [68.58] | — | 7-102898-1 |
| 29 | 2.884 [73.25] | 2.800 [71.12] | — | 7-102898-2 |
| 30 | 2.984 [75.79] | 2.900 [73.66] | 7-103336-3 | 7-102898-3 |
| 32 | 3.184 [80.87] | 3.100 [78.74] | 7-103336-5 | 7-102898-5 |
| 36 | 3.584 [91.03] | 3.500 [88.90] | 7-103336-9 | 7-102898-9 |
| 40 | 3.984 [101.19] | 3.900 [99.06] | 8-103336-3 | 8-102898-3 |

Note: To insert header into PC board, use seating tool with arbor tool or air powered machine—page 152.

Note: All part numbers are RoHS compliant.

ACTION PIN Headers—Unshrouded, Double-Row, .100 x .100 [2.54 x 2.54] Centerline

.025 [0.64] Square Straight Post

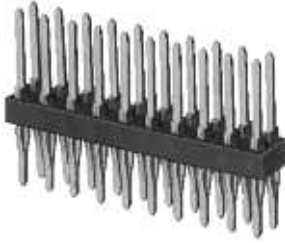

Material and Finish

Housing — Black thermoplastic, 94V-0 rated

Posts — Copper alloy, duplex plated .000030 [0.00076] gold on contact area, .000100-.000200 [0.00254-0.00508] matte tin on termination end, with entire post underplated .000050 [0.00127] nickel

Related Product Data

Mateable Connectors — Refer to the Mating Post Selection Guide — page 90

ACTION PIN Posts — pages 150, 151

Application Tooling — page 152

Accessories

Barrier Insert — page 204

Technical Documents

See mating connector for applicable product and application specifications

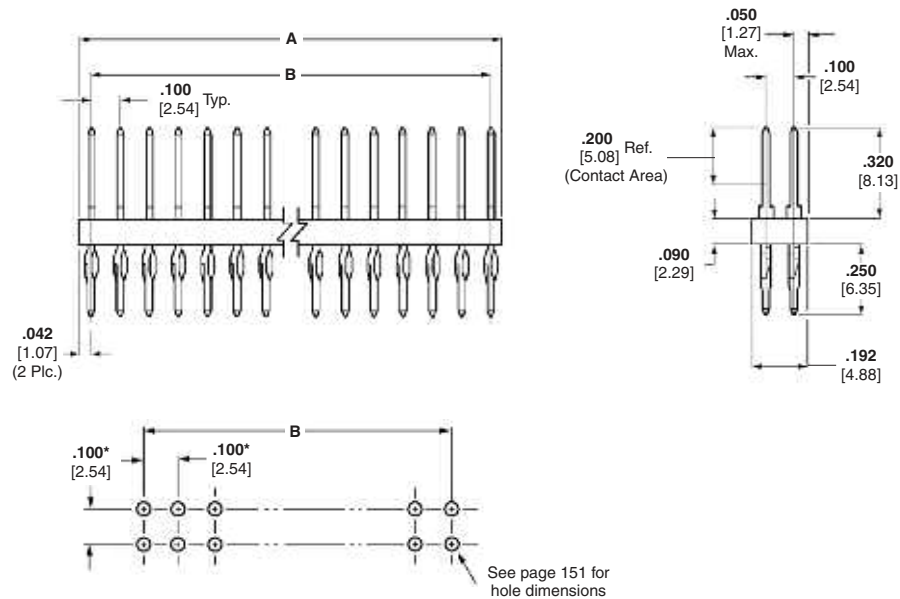

Recommended PC Board Hole Layout

*±.003 [±0.08] tolerances not to accumulate within one connector pattern.

| No. of Pos. | Dimensions | | Part Nos. | |
|-------------|----------------|---------------|---------------------------------|---|
| | A | B | For .062 [1.57] Thick PC Boards | For .093-.125 [.236-3.18] Thick PC Boards |
| 4 | .184 [4.67] | .100 [2.54] | 5-103542-1 | 5-103233-1 |
| 6 | .284 [7.21] | .200 [5.08] | 5-103542-2 | 5-103233-2 |
| 8 | .384 [9.75] | .300 [7.62] | 5-103542-3 | 5-103233-3 |
| 10 | .484 [12.29] | .400 [10.16] | 5-103542-4 | 5-103233-4 |
| 12 | .584 [14.83] | .500 [12.70] | 5-103542-5 | 5-103233-5 |
| 14 | .684 [17.37] | .600 [15.24] | 5-103542-6 | 5-103233-6 |
| 16 | .784 [19.91] | .700 [17.78] | 5-103542-7 | 5-103233-7 |
| 18 | .884 [22.45] | .800 [20.32] | 5-103542-8 | 5-103233-8 |
| 20 | .984 [24.99] | .900 [22.86] | 5-103542-9 | 5-103233-9 |
| 22 | 1.084 [27.53] | 1.000 [25.40] | 6-103542-0 | 6-103233-0 |
| 24 | 1.184 [30.07] | 1.100 [27.94] | 6-103542-1 | 6-103233-1 |
| 26 | 1.284 [32.61] | 1.200 [30.48] | 6-103542-2 | 6-103233-2 |
| 28 | 1.384 [35.15] | 1.300 [33.02] | 6-103542-3 | 6-103233-3 |
| 30 | 1.484 [37.69] | 1.400 [35.56] | 6-103542-4 | 6-103233-4 |
| 32 | 1.584 [40.23] | 1.500 [38.10] | 6-103542-5 | 6-103233-5 |
| 34 | 1.684 [42.77] | 1.600 [40.64] | 6-103542-6 | 6-103233-6 |
| 36 | 1.784 [45.31] | 1.700 [43.18] | 6-103542-7 | 6-103233-7 |
| 38 | 1.884 [47.85] | 1.800 [45.72] | 6-103542-8 | 6-103233-8 |
| 40 | 1.984 [50.39] | 1.900 [48.26] | 6-103542-9 | 6-103233-9 |
| 42 | 2.084 [52.93] | 2.000 [50.80] | 7-103542-0 | 7-103233-0 |
| 46 | 2.284 [58.01] | 2.200 [55.88] | 7-103542-2 | — |
| 50 | 2.484 [63.09] | 2.400 [60.96] | 7-103542-4 | 7-103233-4 |
| 60 | 2.984 [75.79] | 2.900 [73.66] | 7-103542-9 | 7-103233-9 |
| 66 | 3.284 [83.41] | 3.200 [81.28] | 8-103542-2 | — |
| 80 | 3.984 [101.19] | 3.900 [99.06] | 8-103542-9 | 8-103233-9 |

Note: All part numbers are RoHS compliant.

ACTION PIN Headers—Shrouded with .066 [1.68] End Dimension, Double-Row, .100 x .100 [2.54 x 2.54] Centerline

.025 [0.64] Square Straight Post (with Detent Windows, for .093-.125 [.236-3.18] Thick PC Board)

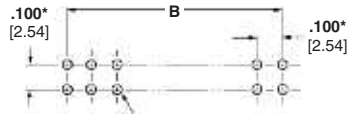
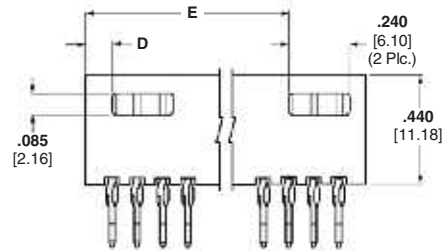
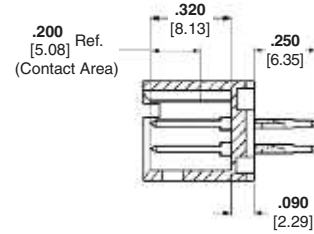
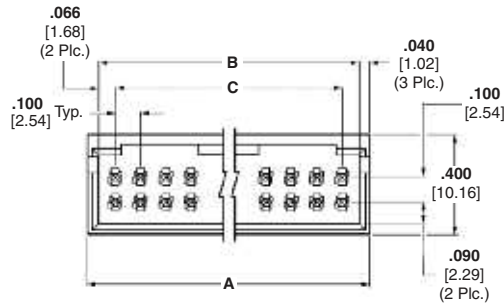

See page 151 for hole dimensions

Recommended PC Board Hole Layout

*±.003 [±0.08] tolerances not to accumulate within one connector pattern.

Material and Finish

Housing — Black thermoplastic, 94V-0 rated

Posts — Copper alloy, duplex plated .000030 [0.00076] gold on contact area, .000100-.000200 [0.00254-0.00508] matte tin on termination end, with entire post underplated .000050 [0.00127] nickel

Related Product Data

Mateable Connectors —

AMPMODU Board Mount Receptacles — pages 176, 179, 180

AMPMODU Wire-Applied Receptacles — pages 217-219

AMPMODU MT Receptacles — pages 256, 257

ACTION PIN Posts — pages 150, 151

Application Tooling — page 152

Accessories

Barrier Insert — page 204

Technical Documents

See mating connector for applicable product and application specifications

| No. of Pos. | Dimensions | | | | | Header Part Nos. |
|-------------|---------------|---------------|---------------|--------------|---------------|------------------|
| | A | B | C | D | E | |
| 6 | .412 [10.46] | .332 [8.43] | .200 [5.08] | .106 [2.69] | — | 5-102699-2 |
| 8 | .512 [13.00] | .432 [10.97] | .300 [7.62] | .106 [2.69] | — | 5-102699-3 |
| 10 | .612 [15.54] | .532 [13.51] | .400 [10.16] | .206 [5.23] | — | 5-102699-4 |
| 12 | .712 [18.08] | .632 [16.05] | .500 [12.70] | .206 [5.23] | — | 5-102699-5 |
| 14 | .812 [20.62] | .732 [18.59] | .600 [15.24] | .306 [7.77] | — | 5-102699-6 |
| 16 | .912 [23.16] | .832 [21.13] | .700 [17.78] | .306 [7.77] | — | 5-102699-7 |
| 18 | 1.012 [25.70] | .932 [23.67] | .800 [20.32] | .406 [10.31] | — | 5-102699-8 |
| 20 | 1.112 [28.24] | 1.032 [26.21] | .900 [22.86] | .106 [2.69] | .806 [20.47] | 5-102699-9 |
| 26 | 1.412 [35.86] | 1.332 [33.83] | 1.200 [30.48] | .106 [2.69] | 1.106 [28.09] | 6-102699-2 |
| 30 | 1.612 [40.94] | 1.532 [38.91] | 1.400 [35.56] | .106 [2.69] | 1.306 [33.17] | 6-102699-4 |
| 34 | 1.812 [46.02] | 1.732 [43.99] | 1.600 [40.64] | .106 [2.69] | 1.506 [38.25] | 6-102699-6 |
| 40 | 2.112 [53.64] | 2.032 [51.61] | 1.900 [48.26] | .106 [2.69] | 1.806 [45.87] | 6-102699-9 |
| 50 | 2.612 [66.34] | 2.532 [64.31] | 2.400 [60.96] | .106 [2.69] | 2.306 [58.57] | 7-102699-3 |
| 60 | 3.112 [79.04] | 3.032 [77.01] | 2.900 [73.66] | .106 [2.69] | 2.806 [71.27] | 7-102699-8 |

Note: All part numbers are RoHS compliant.

ACTION PIN Headers—Shrouded with .150 [3.81] End Dimension, Double-Row, .100 x .100 [2.54 x 2.54] Centerline

.025 [0.64] Square Straight Post (with Detent Windows, for .093-.125 [2.36-3.18] Thick PC Board)



Material and Finish

Housing — Black thermoplastic, 94V-0 rated

Posts — Copper alloy, duplex plated .000030 [0.00076] gold on contact area, .000100-.000200 [0.00254-0.00508] matte tin on termination end, with entire post underplated .000050 [0.00127] nickel

Related Product Data

Mateable Connectors —

AMPMODU MTE Receptacles — pages 232, 233

ACTION PIN Posts — pages 150, 151

Application Tooling — page 152

Accessories

Barrier Insert — page 204

Technical Documents

See mating connector for applicable product and application specifications

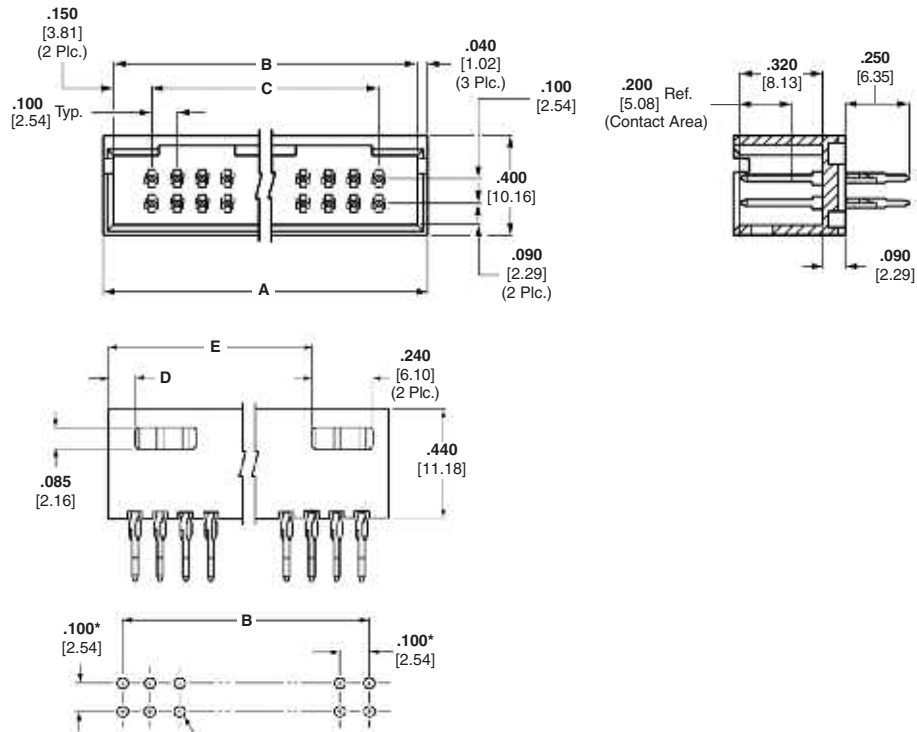

See page 151 for hole dimensions

Recommended PC Board Hole Layout

*±.003 [±0.08] tolerances not to accumulate within one connector pattern.

| No. of Pos. | Dimensions | | | | | Header Part Nos. |
|-------------|---------------|---------------|---------------|--------------|---------------|------------------|
| | A | B | C | D | E | |
| 6 | .580 [14.73] | .500 [8.43] | .200 [5.08] | .190 [4.83] | — | 6-102557-0 |
| 8 | .680 [17.27] | .600 [10.97] | .300 [7.62] | .190 [4.83] | — | 6-102557-1 |
| 10 | .780 [19.81] | .700 [17.78] | .400 [10.16] | .290 [7.37] | — | 5-102557-9 |
| 12 | .880 [22.35] | .800 [20.32] | .500 [12.70] | .290 [7.37] | — | 6-102557-2 |
| 14 | .980 [24.89] | .900 [22.86] | .600 [15.24] | .390 [9.91] | — | 6-102557-3 |
| 16 | 1.080 [27.43] | 1.000 [25.40] | .700 [17.78] | .390 [9.91] | — | 6-102557-4 |
| 18 | 1.180 [29.97] | 1.100 [27.94] | .800 [20.32] | .490 [10.31] | — | 6-102557-5 |
| 20 | 1.280 [32.51] | 1.200 [30.48] | .900 [22.86] | .190 [4.83] | .890 [22.61] | 5-102557-2 |
| 24 | 1.480 [37.59] | 1.400 [35.56] | 1.100 [27.94] | .190 [4.83] | 1.090 [27.69] | 6-102557-7 |
| 26 | 1.580 [40.13] | 1.500 [38.10] | 1.200 [30.48] | .190 [4.83] | 1.190 [30.23] | 5-102557-3 |
| 30 | 1.780 [45.21] | 1.700 [43.18] | 1.400 [35.56] | .190 [4.83] | 1.390 [35.31] | 5-102557-4 |
| 34 | 1.980 [50.29] | 1.900 [48.26] | 1.600 [40.64] | .190 [4.83] | 1.590 [40.39] | 5-102557-5 |
| 40 | 2.280 [57.91] | 2.200 [55.88] | 1.900 [48.26] | .190 [4.83] | 1.890 [48.01] | 5-102557-1 |
| 50 | 2.780 [70.61] | 2.700 [68.58] | 2.400 [60.96] | .190 [4.83] | 2.390 [60.71] | 5-102557-6 |
| 60 | 3.280 [83.31] | 3.200 [81.28] | 2.900 [73.66] | .190 [4.83] | 2.890 [73.41] | 5-102557-7 |

Note: All part numbers are RoHS compliant.

ACTION PIN Press-Fit Posts

The Reliable Plated-Through Hole Interconnect

Solderless interconnections have been popular in electrical and electronic applications with world-wide success for decades. They provide reliable electrical and mechanical stability and offer applied-cost savings across the board. For PC board applications, compliant ACTION PIN posts provide these features:

- Large gas-tight contact zone
- High reliability due to stored energy
- More resistant to damage to plated-through holes during installation
- Especially suited for multilayer PC boards
- Less costly board manufacturing due to larger hole tolerances compared to use of solid pins
- Application can be made by end-user
- Repairability—contact can be replaced in the same pin location (two repairs)
- Installation with no heat cycling of board
- Permits mass insertion by minimizing forces needed to insert pins as compared to solid pin press-fit application
- Significant applied-cost savings in many applications

Since compliant ACTION PIN posts do not have to be soldered, problems associated with solder are eliminated, such as:

- Faulty solder joints
- Solder fumes; contaminants are deposited on the contacts
- Solder spots; short circuits between printed circuits
- Flux residuals
- Thermal strain on printed circuit boards and components
- Degassing of plated-through holes

Solderless press-fit interconnections using compliant pins are primarily integrated in, but not limited to, backplanes.

Solderless press-fit interconnections are used in racks, especially where connectors must be fixed on the solder side of the PC board and/or component side. In these applications, the holes for ACTION PIN post connectors are covered during the soldering process and press-fitting is performed after soldering.

Other applications for ACTION PIN post interconnections include PC boards that incorporate components using surface mount technology (SMT). Here, too, press-fit interconnections can be applied after soldering, thus eliminating complications associated with connectors suitable for surface mounting.

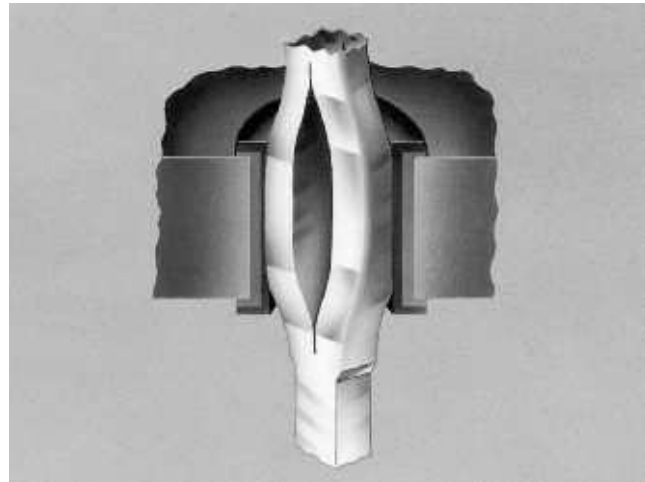

Principle of the Compliant ACTION PIN Post

When a compliant ACTION PIN post is inserted into a plated-through hole, two spring members are compressed, exerting force against the hole for a gas-tight connection. The diameter of the hole is smaller than the diagonal size of the pin (see cross-section illustration below).

The beam characteristics of the pin are designed so that a plastic, as well as an elastic, deformation takes place during insertion. The two spring members compress to different degrees to accommodate hole tolerances. The compliant pin also reduces strain on the board. With a rigid pin, the elastic strain energy is stored entirely in the board, leading to damage of the plated-through holes. With the compliant ACTION PIN post, the residual force of the elastic deformation maintains stored energy to produce a tight contact zone between the pin and the plated-through hole. This maintains long-term electrical and mechanical reliability of the interconnection.



**Minimum
Hole Dia.**
.037 [0.94]

**Maximum
Hole Dia.**
.043 [1.09]

Cross-Section Area of ACTION PIN Press-Fit Post in Printed Circuit Board Holes

ACTION PIN Press-Fit Posts (Continued)



ACTION PIN posts provide a more reliable press-fit connection. Localized pressure in the interface area provides oxide break-through and prevents corrosion better in many of the harshest environments to help provide a reliable connection. Also, radial and axial distortion are controlled to meet today's standards for multilayer board applications.

PC Board Thickness

ACTION PIN posts are designed for use in a variety of PC board thicknesses. However, certain ACTION PIN posts are to be used in specific ranges of board thicknesses. To promote optimum performance, the recommended board thicknesses provided with the connector being used must be followed.

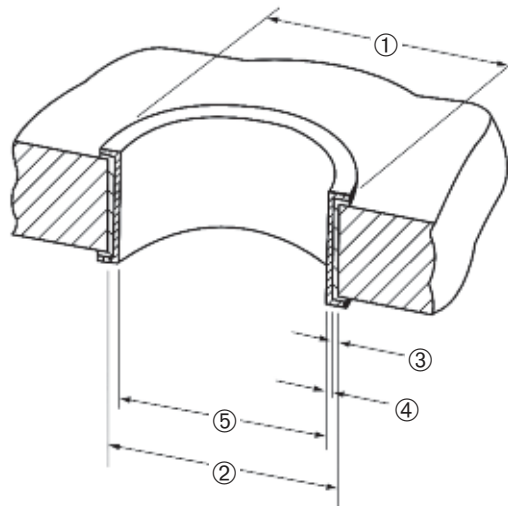

- ① Annular Ring (See Note)
- ② Drilled Hole
- ③ Copper Thickness
- ④ Tin-lead Thickness
- ⑤ Plated-Through Hole

ACTION PIN Post/PC Board Applications

| ACTION PIN Contact Material Thickness | Drilled Hole Diameter ^② | Plating Thicknesses | | Plated-Through Hole Diameter ^⑤ | Distortion Specification* | |
|---------------------------------------|---|-----------------------|-----------------------|---|---------------------------|-------------|
| | | Copper ^{③*} | Tin-lead ^④ | | Average | Maximum |
| .025 [0.64] | .0453 ^{+0.001} [1.151 ^{+0.03}] | .001-.003 [0.03-0.08] | .0003 [0.008]Min. | .037-.043 [0.94-1.09] | .0015 [0.038] | .002 [0.05] |

*Maximum hardness of copper layer is 150 Knoop.
 **Radial hole distortion.

Note: Recommended annular ring diameter is hole diameter plus .020 [0.51].

Application Tooling for AMPMODU Headers with ACTION PIN Posts

ACTION PIN Post Replacement Tooling



Rear Insertion/Extraction Tool No. 265871-7 (Ref. 408-2636) Includes:

- Impact Tool No. 380392-8
- Removal Tool No. 265964-1
- Replacement Tip No. 308554-1

Single-Row Connector Seating Tools

Tooling Assembly No. 91171-1 is used to install single-row AMPMODU headers with ACTION PIN posts into PC boards.

Pin headers with ACTION PIN posts allow high speed, solderless back-plane construction through press-fit application. Press fitting connectors to printed circuit boards requires special seating tools which transfer application force directly to the contacts.

Force applied to the tool to seat the connectors can be provided by the TE seating machines shown on this page.

For tooling information, call the TE Automation Group 1-800-722-1111.

Double-Row Connector Seating Tools

| Header Size (No. of Pos.) | Tool Assembly No. |
|---------------------------|-------------------|
| 4 | 91170-1 |
| 6 | 91170-1 |
| 8 | 91170-2 |
| 12 | 91170-5 |
| 14 | 91170-6 |
| 16 | 91170-7 |
| 20 | 91170-9 |
| 24 | 1-91170-1 |
| 30 | 1-91170-4 |
| 36 | 1-91170-7 |
| 40 | 1-91170-9 |
| 50 | 2-91170-4 |
| 60 | 2-91170-9 |
| 80 | 3-91170-2 |
| 96 | 3-91170-5 |
| 100 | 3-91170-6 |
| 120 | 3-91170-8 |
| 140 | 4-91170-0 |
| 200 | 4-91170-2 |

Triple-Row Connector Seating Tools

| Header Size (No. of Pos.) | Tool Assembly No. |
|---------------------------|-------------------|
| 96 | 91169-8 |
| 105 | 91169-6 |
| 120 | 91169-7 |
| 150 | 91169-3 |
| 195 | 91169-2 |
| 204 | 91169-1 |
| 210 | 91169-5 |
| 300 | 91169-9 |

Application Tooling for ACTION PIN Posts

5



BMEP 5T



AEP 6T

ASG Servo Electric Presses

TE offers a wide range of servo-electric presses for the application of press-fit connectors. Systems are available with varying force capacity, board size capacity and process capability. Each system features real-time force feedback and PC control to allow the highest level of control and traceability. Every connector

pressed is monitored to confirm that maximum force is not exceeded and minimum force is met. Each system controls force, height and speed to allow termination of the pressing cycle by force or height parameters. Complete SPC data is available as each connector press cycle is monitored and stored.

Please see the matrix below and contact TE Automation Group at 1-800-722-1111 for assistance in understanding which system will best meet your needs.

| Press Model | Description | Max Pressing Force tons [kN] | Max Board Size (L x W) in [mm] |
|-------------|--|------------------------------|--------------------------------|
| BMEP 3T | Semi-automatic, benchtop servo-electric press | 3 [26.7] | 18 x 24 [460 x 610] |
| BMEP 5T | Semi-automatic, benchtop servo-electric press | 5 [44.5] | 18 x 24 [460 x 610] |
| MEP 6T | Semi-automatic, stand-alone servo-electric press | 6 [53.4] | 24 x 36 [610 x 914] |
| MEP 12T | Semi-automatic, stand-alone servo-electric press | 12 [106.8] | 30 x 36 [762 x 914] |
| AEP 12T | Automatic, inline servo-electric press | 12 [106.8] | 36 x 48 [914 x 1219] |
| AEP 6T | Automatic, stand alone servo-electric press | 6 [53.4] | 30 x 36 [762 x 914] |

Note: All part numbers are RoHS compliant.

Application Tooling for Post Insertion

TE offers a wide range of application tooling solutions ranging from stand alone manual insertion systems through fully automatic inline systems. Please contact your local TE representative or the TE Tooling Assistance Center at 1-800-722-1111 for help in finding the right solution to meet your particular requirements.

Modular Insertion System Bench Machine No. 217600-1

This machine uses TE insertion heads to install a variety of printed circuit board products at rates of 2,000 per hour. The printed circuit board is placed in a Board Holding Fixture which is attached to a two-hand controlled mechanism. The operator moves the board over the machine anvil; a switch in the anvil actuates the machine when the printed circuit board is placed on the anvil. A spotlight illuminates the insertion area.

Consult TE for further information on this machine and the insertion heads.



P300 and P350 Automatic Insertion Machines

The P300 and P350 are automatic insertion machines for the application of reeled compliant pin and thru-hole products. Systems are available as stand alone or fully inline with SMEMA compatible conveyor system. Up to 3 different insertion heads can be mounted on a system allowing one machine to apply up to 3 different products. Insertion rates of up to 3 insertions per second on the P300 and up to 5 insertions per second on a P350 are possible (application dependent). PCBs up to 15.5" x 23.5" [400x600mm] on the P300 and up to 17.5" x 17.5" [450x450mm] on the P350 can be processed by high speed XY positioning tables. A wide range of options, including force monitoring, PCB vision correct, and PCB thickness measurement are available to meet your performance and production flexibility requirements.

Note: All part numbers are RoHS compliant.

ACTION PIN Stacking Connector System (Non-Intermateable with AMPMODU Connectors)

Product Facts

- Can stack multiple printed circuit boards without the need of a mother board
- Connect bus lines in the shortest possible distance
- Receptacle assembly has ACTION PIN posts for solderless board mounting
- Can be mounted onto the board simply by press fitting with Mini-Press
- Receptacle assembly is easy to service and replace (up to 2 times)
- Receptacle contacts are of fork design to mate with posts at two points. Virtually eliminates danger of scooping at mating/unmating
- Stacking dimensions are 13.4 [.528] or 19.0 [.748] when using receptacle assemblies together, and 13.9 [.547] or 19.5 [.768] when using a combination of receptacle and post header assemblies
- Accepts 1.6 [.062] thick boards
- Housing provided with polarization to help prevent mismating
- Housing made of chemical-resistant glass-filled PBT, black in color
- Contacts are of copper alloy material with high spring characteristics, gold-over-nickel plated
- Post hood available to protect the post portion of receptacle contacts. Can be selected depending on stacking dimensions
- Connectors available in sizes of 26, 30, 34, 40, 50 and 60 positions
- Product specification: 108-5197

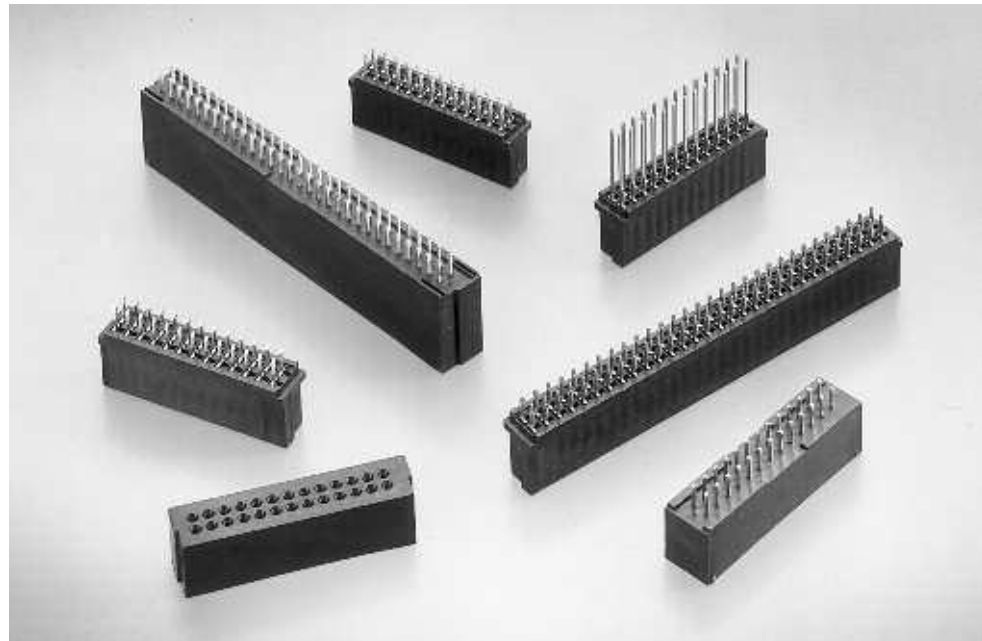

ACTION PIN Stacking Connectors are a family of two-piece connectors used to stack multiple printed circuit boards in parallel. They have been developed to provide a more reliable and economical means of compact wiring and high-density packaging inside a variety of electronic equipment.

The connectors have many advanced features: they can be used to connect

bus lines in the shortest possible distance without the need of a mother board, thus permitting effective utilization of space above the board; compared with other methods of jumper connection using cable connectors, they make the overall board layout more clean and straight for compact packaging.

Contacts are on 2.54 x 2.54 [.100 x .100] grid. The connectors are available in

sizes of 26, 30, 34, 40, 50 and 60 positions. ACTION PIN Stacking Connectors consist of a receptacle assembly, a mating post header and a post hood to protect the post portion of the receptacle assembly.

A complete description of the ACTION PIN Stacking Connectors is presented on the following page (155).

ACTION PIN Stacking Connector System (Non-Intermateable with AMPMODU Connectors) (Continued)

Receptacle Assembly

The receptacle assembly features reliability and economy characteristic of this product line.

The mating portion of its built-in receptacle contacts is a fork design, highly resilient and helps prevent damage to contacts by scooping at mating/unmating.

On the board mount side of the assembly are 0.55 [.022] square ACTION PIN posts.

No soldering is required to mount the assembly on the board, the posts being simply, press fit into the board's 0.825 [.032] diameter holes.

Two types of receptacle assemblies are available;

one is used with an outermost board and the other with intermediary boards. A solder version is also available for the outer board mount assembly.

Post Hood

When using the intermediary board mount receptacle assembly, this post hood is used to protect the post portion of the assembly. The post hood is available in two types: one with the housing height of 10.0 [.394] and the other with the housing height of 15.7 [.618]. They can be selected, depending on stacking dimensions.

Post Header

The post header is mounted onto the outer board on the other side of the board to

which an outer board mount receptacle assembly is applied. The post header is preloaded with 0.50 [.022] square soldering posts. These posts are protected by the side walls of the housing.

Stacking dimensions provided by this connector line are as follows:

When the outer board receptacle and intermediary board receptacle assemblies are used 13.4 [.528] or 19.0 [.748].

When the intermediary board receptacle assembly and the post header assembly are used 13.9 [.547] or 19.5 [.768].

Typical Application

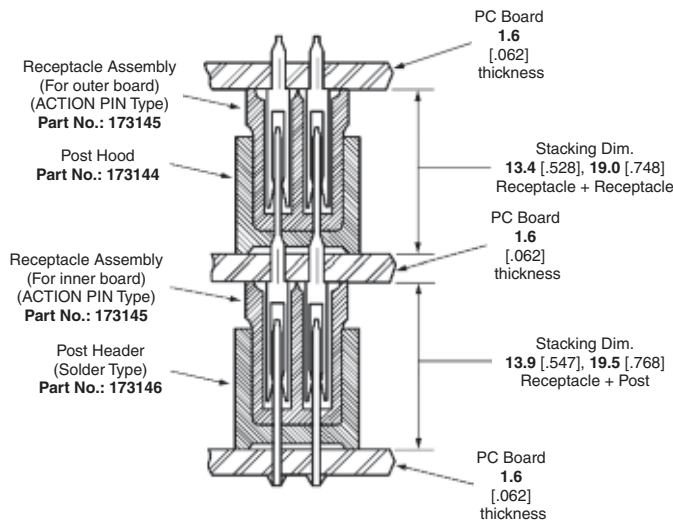

Note: All part numbers are RoHS compliant.

Post Hood (Non-Intermateable with AMPMODU Connectors)



The post hood, mounted onto the post of the intermediary receptacle assembly, protects the post and serves as a header assembly when stacking several boards.

Material

Black glass-filled PBT, 94V-0 rated

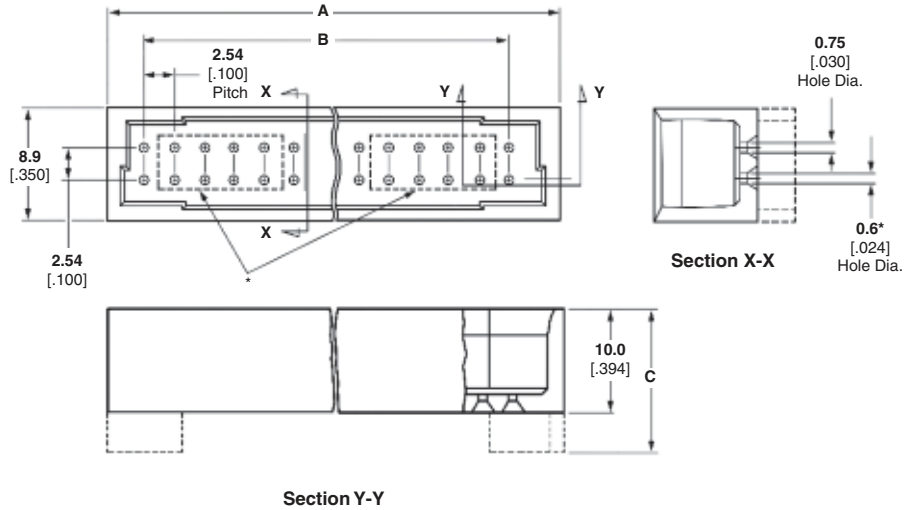

Stacking Connectors,
Post Hood

5

| Acceptable Post Length | No. of Pos. | Dimensions (See Note.) | | | Post Hood Part Nos. |
|---|-------------|------------------------|---------------|-------------|---------------------|
| | | A | B | C | |
| For 8.9 [.350] or 10.9 [.429] (For Stacking Dimension) 13.4 [.528] | 26 | 38.1 [1.500] | 30.48 [1.200] | 10.0 [.394] | 1-173144-1 |
| | 30 | 43.2 [1.700] | 33.56 [1.321] | 10.0 [.394] | 173144-2 |
| | 34 | 48.3 [1.900] | 40.64 [1.600] | 10.0 [.394] | 1-173144-2 |
| | 40 | 55.9 [2.200] | 48.26 [1.900] | 10.0 [.394] | 173144-3 |
| | 50 | 68.6 [2.700] | 65.96 [2.597] | 10.0 [.394] | 173144-4 |
| | 60 | 81.3 [3.200] | 73.66 [2.900] | 10.0 [.394] | 173144-5 |
| For 14.5 [.571] or 16.5 [.650] (For Stacking Dimension) 19.0 [.748] | 26 | 38.1 [1.500] | 30.48 [1.200] | 15.6 [.614] | 1-173144-3 |
| | 30 | 43.2 [1.700] | 33.56 [1.321] | 15.6 [.614] | 173144-7 |
| | 34 | 48.3 [1.900] | 40.64 [1.600] | 15.6 [.614] | 1-173144-4 |
| | 40 | 55.9 [2.200] | 48.26 [1.900] | 15.6 [.614] | 173144-8 |
| | 50 | 68.6 [2.700] | 65.96 [2.597] | 15.6 [.614] | 3-173144-8* |
| | 60 | 81.3 [3.200] | 73.66 [2.900] | 15.6 [.614] | 173144-9 |
| | | | | | 1-173144-0 |

*0.60 [.024] dia. applies to 16 holes on both sides, except Part No. 3-173144-8.

Note: All part numbers are RoHS compliant.

Receptacle Assembly for Outer Board (With 0.55 [.022] Square Post)

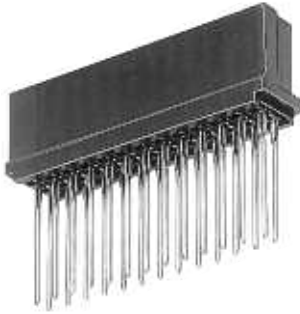

Material and Finish

Housing — Black glass-filled PBT, 94V-0 rated

Contacts — Copper alloy, plated 0.00020 [.000008] gold on contact area and post mating area, gold flash on ACTION PIN tail or 0.000070 [.0000027] tin on solder tail, with entire contact underplated 0.00130 [.000050] nickel

Application Tooling shown on page 162.

PC Board Mounting Dimensions

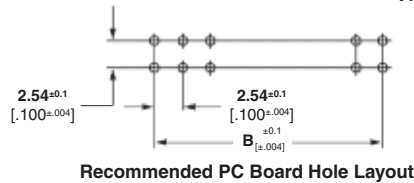
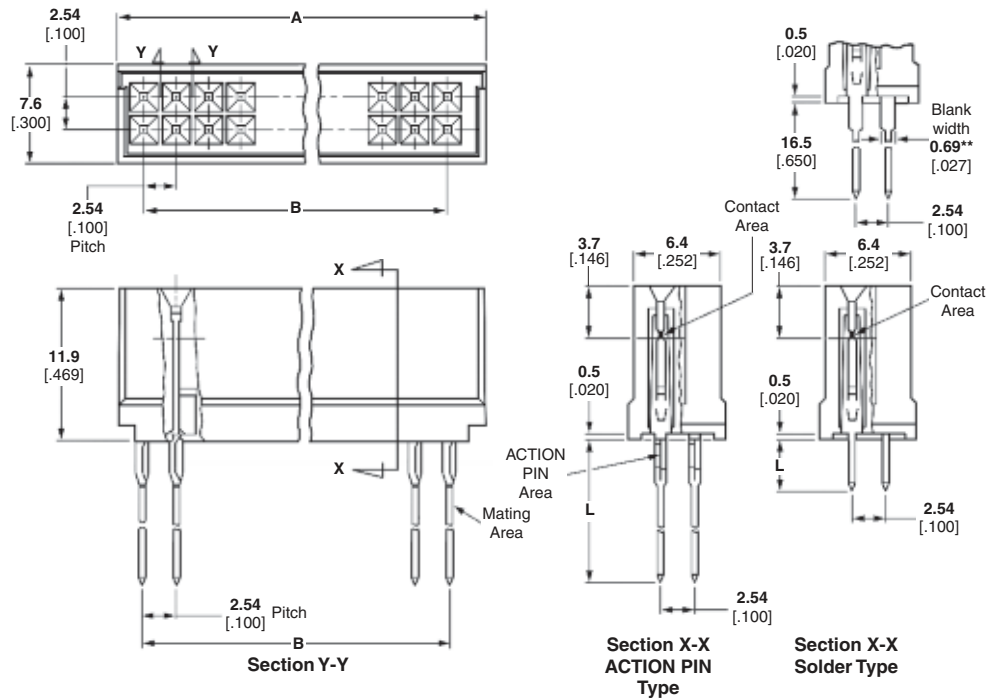
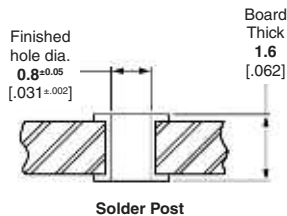
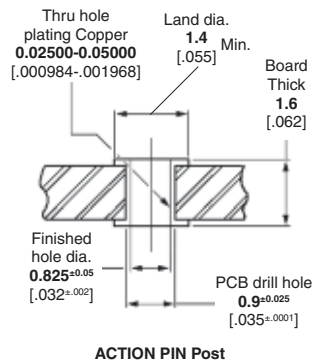

For Outer Board

| Type | Post Length L | No. of Pos. | Dimensions (See Note.) | | Receptacle Assembly Part Nos. |
|-----------------|---------------|-------------|------------------------|---------------|-------------------------------|
| | | | A | B | |
| ACTION PIN Post | 4.2* | 26 | 35.6 [1.402] | 30.48 [1.200] | 1-173145-7 |
| | | 30 | 40.6 [1.598] | 35.56 [1.400] | 173145-2 |
| | | 34 | 45.7 [1.799] | 40.64 [1.600] | 1-173145-8 |
| | | 40 | 53.3 [2.098] | 48.26 [1.900] | 173145-3 |
| | | 50 | 66.0 [2.598] | 60.96 [2.400] | 173145-4 |
| | | 60 | 78.7 [3.098] | 73.66 [2.900] | 173145-5 |
| Solder Post | 4.2* | 26 | 35.6 [1.402] | 30.48 [1.200] | 2-173145-8 |
| | | 30 | 40.6 [1.598] | 35.56 [1.400] | 2-173145-4 |
| | | 34 | 45.7 [1.799] | 40.64 [1.600] | 2-173145-9 |
| | | 40 | 53.3 [2.098] | 48.26 [1.900] | 2-173145-5 |
| | | 50 | 66.0 [2.598] | 60.96 [2.400] | 2-173145-6 |
| | | 60 | 78.7 [3.098] | 73.66 [2.900] | 2-173145-7 3-173145-0** |

*After mounted receptacle assembly is on board, dimension of extrude length from board is 2.6 [.102].
**Post Length = 17.0 [.669] , Blank Width = 0.69 [.027] (see above figure) (finished hole dia. = 1.0 [.039]).

Note: All part numbers are RoHS compliant.

Receptacle Assemblies with ACTION PIN Posts (Non-Intermateable with AMPMODU Connectors)

Receptacle Assembly for Inner Board (With 0.55 [.022] Square Post)



Material and Finish

Housing — Black glass-filled PBT, 94V-0 rated

Contacts — Copper alloy, plated 0.00020 [.000008] gold on contact area and post mating area, gold flash on ACTION PIN tail or 0.000070 [.0000027] tin on solder tail, with entire contact underplated 0.00130 [.000050] nickel

Application Tooling shown on page 162.

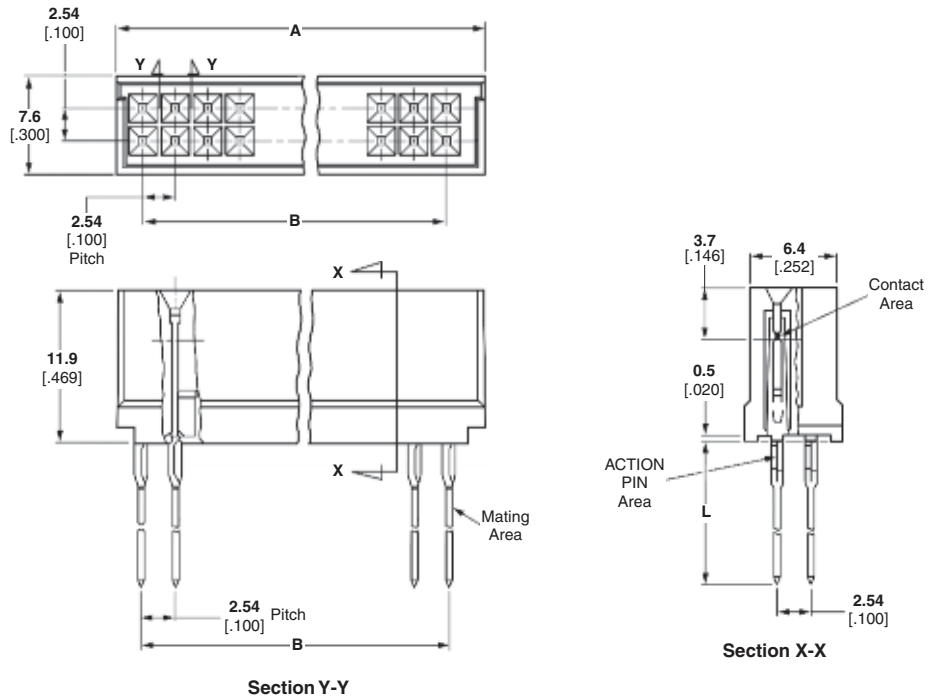

PC Board Mounting Dimensions

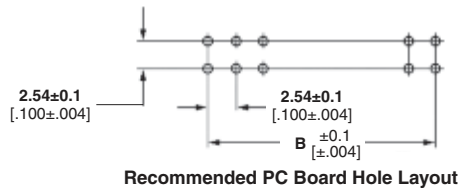
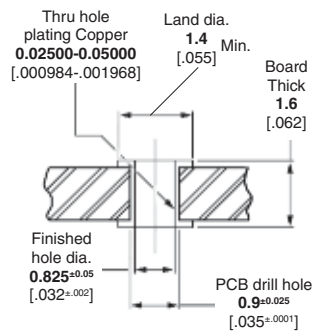

For Inner Board

| Stacking Dimensions | Post Length L | No. of Pos. | Dimensions (See Note.) | | Receptacle Assembly Part Nos. |
|---------------------|---------------|-------------|------------------------|---------------|-------------------------------|
| | | | A | B | |
| 13.4 [.528] | 8.9 .350 | 30 | 40.6 [1.598] | 35.56 [1.400] | 3-173145-2 |
| | | 34 | 45.7 [1.799] | 40.64 [1.600] | 3-173145-7 |
| | | 40 | 53.3 [2.098] | 48.26 [1.900] | 3-173145-3 |
| | | 50 | 66.0 [2.598] | 60.96 [2.400] | 3-173145-1* |
| | | 60 | 78.7 [3.098] | 73.66 [2.900] | 3-173145-4 |
| | 10.9 .429 | 26 | 35.6 [1.402] | 30.48 [1.200] | 1-173145-9 |
| | | 30 | 40.6 [1.598] | 35.56 [1.400] | 173145-7 |
| | | 34 | 45.7 [1.799] | 40.64 [1.600] | 2-173145-0 |
| | | 40 | 53.3 [2.098] | 48.26 [1.900] | 173145-8 |
| | | 50 | 66.0 [2.598] | 60.96 [2.400] | 173145-9 |
| | | 60 | 78.7 [3.098] | 73.66 [2.900] | 1-173145-0 |

*Contact area and post mating area: 0.00050 [.000020] min. gold over 0.00130 [.000050] min. nickel plated.

Note: All part numbers are RoHS compliant.

Stacking Connectors, Receptacles

5

**Receptacle Assemblies with ACTION PIN Posts
(Non-Intermateable with AMPMODU Connectors)** (Continued)

For Inner Board (Continued)

| Stacking Dimensions | Post Length L | No. of Pos. | Dimensions (See Note.) | | Receptacle Assembly Part Nos. |
|---------------------|---------------|-------------|------------------------|---------------|-------------------------------|
| | | | A | B | |
| 19.0 [.748] | 14.5 [.571] | 26 | 35.6 [1.402] | 30.48 [1.200] | 4-173145-2 |
| | | 30 | 40.6 [1.598] | 35.56 [1.400] | 3-173145-8 |
| | | 34 | 45.7 [1.799] | 40.64 [1.600] | 4-173145-3 |
| | | 40 | 53.3 [2.098] | 48.26 [1.900] | 3-173145-9 |
| | | 50 | 66.0 [2.598] | 60.96 [2.400] | 4-173145-0 |
| | | 60 | 78.7 [3.098] | 73.66 [2.900] | 4-173145-1 |
| | 16.5 [.650] | 26 | 35.6 [1.402] | 30.48 [1.200] | 2-173145-1 |
| | | 30 | 40.6 [1.598] | 35.56 [1.400] | 1-173145-2 |
| | | 34 | 45.7 [1.799] | 40.64 [1.600] | 2-173145-2 |
| | | 40 | 53.3 [2.098] | 48.26 [1.900] | 1-173145-3 |
| | | 50 | 66.0 [2.598] | 60.96 [2.400] | 1-173145-4 |
| | | 60 | 78.7 [3.098] | 73.66 [2.900] | 1-173145-5 |

*Contact area and post mating area: 0.00050 [.000020] min. gold over 0.00130 [.000050] min. nickel plated.

Note: All part numbers are RoHS compliant.

Post Headers with Solder Posts (Non-Intermateable with AMPMODU Connectors)

Post Header (With 0.55 [.022] Square Post)

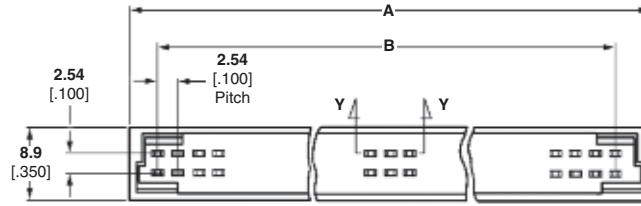

Material and Finish

Housing — Black glass-filled PBT, 94V-0 rated

Posts — Copper alloy, plated 0.00020 [.000008] gold on contact area, 0.000070 [.0000027] min. tin on solder tail, with entire post underplated 0.00130 [.000050] nickel

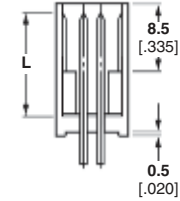
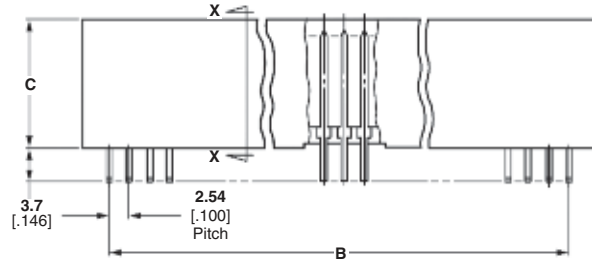

PC Board Mounting Dimensions

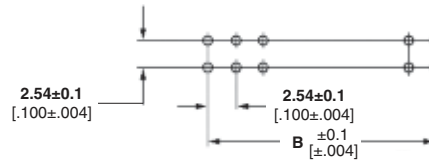
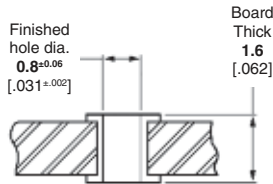

Recommended PC Board Hole Layout

| Stacking Dimensions | Post Length L | No. of Pos. | Dimensions (See Note.) | | | Part Nos. of Post Header Assembly |
|---------------------|---------------|-------------|------------------------|---------------|-------------|-----------------------------------|
| | | | A | B | C | |
| 13.9 [.547] | 5.8 [.228] | 26 | 38.1 [1.500] | 30.48 [1.200] | 10.5 [.413] | 3-173146-5 |
| | | 30 | 43.2 [1.700] | 35.56 [1.400] | 10.5 [.413] | 3-173146-1 |
| | | 34 | 48.3 [1.900] | 40.64 [1.600] | 10.5 [.413] | 3-173146-6 |
| | | 40 | 55.9 [2.200] | 48.26 [1.900] | 10.5 [.413] | 3-173146-2 |
| | | 50 | 68.6 [2.700] | 60.96 [2.400] | 10.5 [.413] | 3-173146-3 |
| | | 60 | 81.3 [3.200] | 73.66 [2.900] | 10.5 [.413] | 3-173146-4 |
| | 7.8 [.307] | 26 | 38.1 [1.500] | 30.48 [1.200] | 10.5 [.413] | 2-173146-1 |
| | | 30 | 43.2 [1.700] | 35.56 [1.400] | 10.5 [.413] | 1-173146-7 |
| | | 34 | 48.3 [1.900] | 40.64 [1.600] | 10.5 [.413] | 2-173146-2 |
| | | 40 | 55.9 [2.200] | 48.26 [1.900] | 10.5 [.413] | 1-173146-8 |
| | | 50 | 68.6 [2.700] | 60.96 [2.400] | 10.5 [.413] | 4-173146-3* |
| | | 60 | 81.3 [3.200] | 73.66 [2.900] | 10.5 [.413] | 1-173146-9 |
| | | 60 | 81.3 [3.200] | 73.66 [2.900] | 10.5 [.413] | 2-173146-0 |

*Contact mating area: 0.00050 [.000020] min. gold over 0.00130 [.000050] min. nickel plated.

Note: All part numbers are RoHS compliant.

**Post Headers with Solder Posts
(Non-Intermateable with AMPMODU Connectors)** (Continued)

| Stacking Dimensions | Post Length L | No. of Pos. | Dimensions (See Note.) | | | Part Nos. of Post Header Assembly |
|---------------------|---------------|-------------|------------------------|---------------|-------------|-----------------------------------|
| | | | A | B | C | |
| 19.5 [.768] | 11.4 [.449] | 26 | 38.1 [1.500] | 30.48 [1.200] | 16.1 [.634] | 4-173146-1 |
| | | 30 | 43.2 [1.700] | 35.56 [1.400] | 16.1 [.634] | 3-173146-7 |
| | | 34 | 48.3 [1.900] | 40.64 [1.600] | 16.1 [.634] | 4-173146-2 |
| | | 40 | 55.9 [2.200] | 48.26 [1.900] | 16.1 [.634] | 3-173146-8 |
| | | 50 | 68.6 [2.700] | 60.96 [2.400] | 16.1 [.634] | 3-173146-9 |
| | | 60 | 81.3 [3.200] | 73.66 [2.900] | 16.1 [.634] | 4-173146-0 |
| | 13.4 [.528] | 26 | 38.1 [1.500] | 30.48 [1.200] | 16.1 [.634] | 2-173146-8 |
| | | 30 | 43.2 [1.700] | 35.56 [1.400] | 16.1 [.634] | 2-173146-4 |
| | | 34 | 48.3 [1.900] | 40.64 [1.600] | 16.1 [.634] | 2-173146-9 |
| | | 40 | 55.9 [2.200] | 48.26 [1.900] | 16.1 [.634] | 2-173146-5 |
| | | 50 | 68.6 [2.700] | 60.96 [2.400] | 16.1 [.634] | 2-173146-6 |
| | | 60 | 81.3 [3.200] | 73.66 [2.900] | 16.1 [.634] | 2-173146-7 |

*Contact mating area: 0.00050 [.000020] min. gold over 0.00130 [.000050] min. nickel plated.

Note: All part numbers are RoHS compliant.

Application Tooling for ACTION PIN Stacking Connectors

Mini-Press



| No. of Pos. | Part No. |
|-------------|------------|
| 40 | 1-758030-1 |
| 50 | 1-758030-2 |
| 60 | 1-758030-3 |

The part numbers above include the Mini-Press unit, insertion support plate and press-fit jig.

Mini-Press Unit Part No. 1-758030-3

When ordering a press-fit jig only, consult the table below.

Press-fit Jig (separate order)

| No. of Pos. | Part No. |
|-------------|----------|
| 26 | 907459-1 |
| 30 | 907459-2 |
| 34 | 907459-3 |
| 40 | 907459-4 |
| 50 | 907459-5 |
| 60 | 907459-6 |

Also, optional insertion support plates are obtainable by separate order to meet your specific requirements for improved board handling.

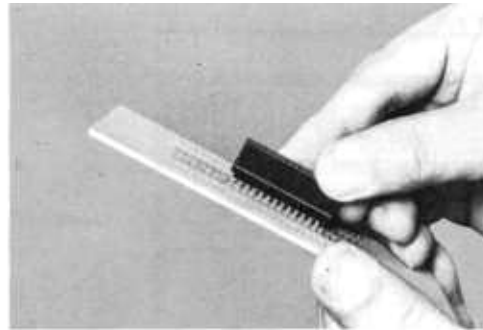

1. Insert connector into the board tentatively (Be sure that connector is in the right direction).

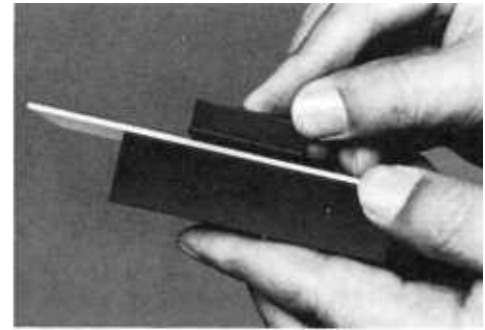

2. Attach insertion support plate to the leg portion of connector from below.



3. Set insertion support plate in place by butting it against Mini-Press platform.

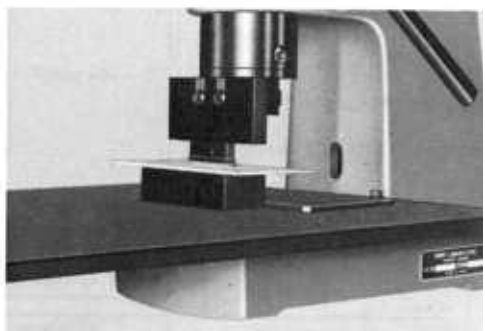

4. By pressing Mini-Press handle down, rest the press-fit jig against connector.

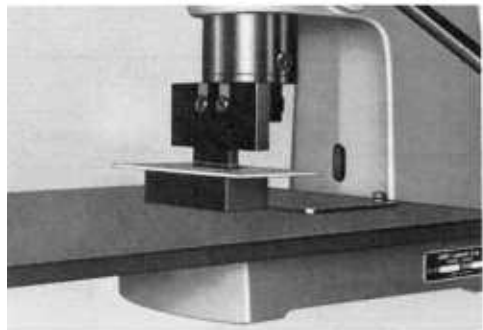

5. Press handle down gently and insert connector into the board.

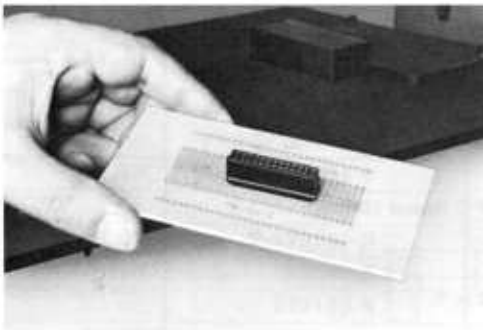

6. Now connector has been mounted to the board securely.



Insertion Support Unit
(Option)



Note: All part numbers are RoHS compliant.

.025 [0.64] Square Posts

Bandolier Posts (Uninsulated)

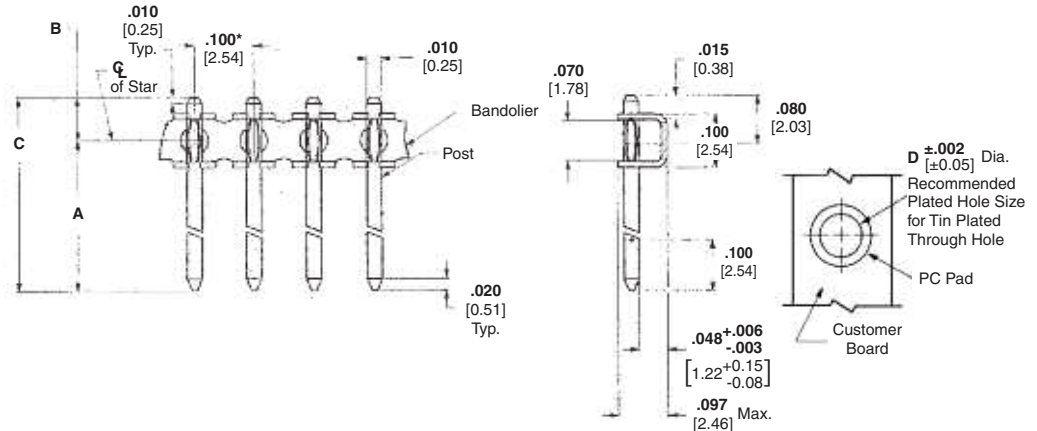

Material and Finish

Bandolier — Brass

Posts — Phosphor bronze, plated as follows:

Plating A — Duplex plated .000030 [0.00076] gold on contact area, .000100-.000200 [0.00254-0.00508] tin on solder area, with entire post underplated. .000050 [0.00127] nickel

Plating B — Duplex plated .000015 [0.00038] gold on contact area, .000100-.000200 [0.00254-0.00508] tin on solder area, with entire post underplated. .000050 [0.00127] nickel

Plating C — .000100-.000200 [0.00254-0.00508] tin over .000050 [0.00127] nickel on entire post

Related Product Data

Mateable Connectors — Refer to the Mating Post Selection Guide — page 90

Accessories

End Shrouds — page 203

Application Tooling — page 153

Technical Documents

See mating connector for applicable product and application specifications.

Strip Form Posts (Uninsulated)

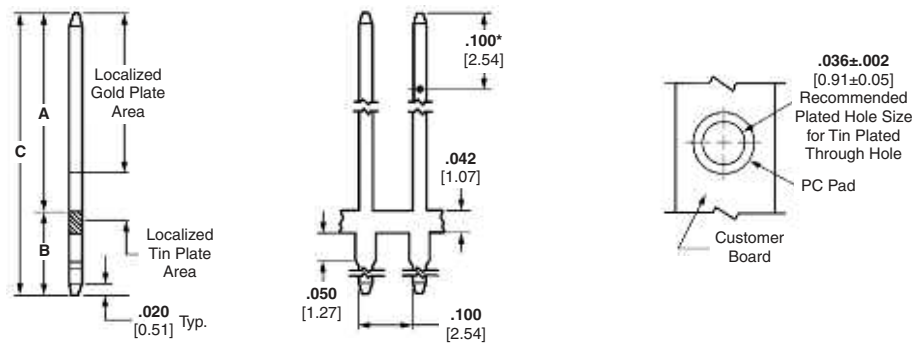

Material and Finish

Posts — Phosphor bronze, plated as follows:

Plating A — Duplex plated .000030 [0.00076] gold on contact area, .000100-.000200 [0.00254-0.00508] tin on solder area, with entire post underplated. .000050 [0.00127] nickel

Plating B — Duplex plated .000015 [0.00038] gold on contact area, .000100-.000200 [0.00254-0.00508] tin on solder area, with entire post underplated. .000050 [0.00127] nickel

Plating C — .000030 [0.00076] gold over .000050 [0.00127] nickel on entire post

Plating D — .000100-.000200 [0.00254-0.00508] tin over .000050 [0.00127] nickel on entire post

| Dimensions | | | | Post Plating/Part Nos. | | | Bandolier Insertion Head |
|-------------|-------------|--------------|-------------|------------------------|------------|------------|--------------------------|
| A | B | C | D | Plating A | Plating B | Plating C | |
| .353 [8.97] | .071 [1.80] | .424 [10.77] | .034 [0.86] | 5-103577-1 | 6-103577-3 | 5-103577-7 | 904592-1 |
| .318 [8.08] | .071 [1.80] | .389 [9.88] | .034 [0.86] | 5-103577-3 | 6-103577-5 | 5-103577-9 | 904591-1 |
| .270 [6.86] | .071 [1.80] | .341 [8.66] | .034 [0.86] | 5-103577-5 | 6-103577-7 | 6-103577-1 | 904590-1 |
| .183 [4.65] | .097 [2.46] | .280 [7.11] | .031 [0.79] | 5-146079-1 | — | — | — |
| | | | | — | — | 6-146079-3 | — |

- Notes:** 1. Posts can be applied using **Hand Tool 91419-1**. *Point of measurement for plating thickness.
 2. Approximate posts per reel—30,000.
 3. The Bandolier Insertion Head can be used on the Comp-U-Sertor II machine or the Modular Insertion System Bench machine (see page 153).
 4. For PCB finishes other than tin, contact TE.

| Dimensions | | | Post Plating/Part Nos. | | | | Post/Tab Insertion Head |
|-------------|--------------|---------------|------------------------|-----------|-----------|-----------|-------------------------|
| A | B | C | Plating A | Plating B | Plating C | Plating D | |
| .210 [5.33] | .227 [5.77] | .437 [11.10] | — | — | 87878-6 | 1-87022-4 | — |
| .278 [7.06] | .165 [4.19] | .443 [11.25] | 5-87623-1 | 5-87623-4 | 87022-1 | 1-87022-0 | 904507-1 |
| .278 [7.06] | .284 [7.21] | .562 [14.27] | — | — | 1-87022-3 | — | — |
| .278 [7.06] | .738 [18.75] | 1.016 [25.81] | — | — | 87022-2 | 87022-4 | — |
| .318 [8.08] | .165 [4.19] | .483 [14.27] | — | — | 4-87022-1 | 4-87022-3 | — |

- Notes:** 1. Approximate Posts per reel—20,000. *Point of measurement for plating thickness.
 2. Other post lengths are available, consult TE.
 3. The Post/Tab Insertion Head can be used on the Comp-U-Sertor II machine or the Modular Insertion System Bench machine (see page 153).
 4. For PCB finishes other than tin, contact TE.

Note: All part numbers are RoHS compliant.

AMPMODU .025 [0.64] Square Continuous Posts

Features of .025 [0.64] Square Continuous Posts

- Brass drawn wire for posts
- .400 to 1.000 [10.16 to 25.40] overall pin length (.010 [0.25] increments)
- Plating Options:
 - Tin
 - 15µ in. gold
 - 30µ in. gold
- Star feature also available

Benefits

- Less expensive than bandolier style posts
- Can be placed on printed circuit boards at any desired centerline
- Less scrap material (no carrier strip)

Technical Documents — page 276
Application Specification
 114-13011



TE now offers AMPMODU .025 [0.64] Square Continuous Posts. These posts can be used instead of the original posts that come on a bandolier style carrier strip. These posts are on a reel, but the posts are 'notched' at the desired length (no carrier strip is needed). This feature allows more versatility by providing post lengths from .400 to 1.000 [10.16 to 25.40], available in increments of .010 [0.25].

The posts are brass drawn wire and are inserted into a printed circuit board via application tooling at any centerline configuration. They can be used for wire wrap applications or mated to a receptacle.

The current rating is 3 amps. The posts are available plated with tin, 15µ in. gold, or 30µ in. gold. Other platings are available upon request.

TE application tooling is a modular head (Part Number 904641-1) placed on the Modular Insertion System Bench Machine (Part Number 217600-1.)

Note: All part numbers are RoHS compliant.

AMPMODU .025 [0.64] Square Continuous Posts (Continued)

Pre-Plated Tin

| Part Number | | Description Post Length |
|-------------|------------------|----------------------------|
| Square | Square with Star | |
| 147333-1 | 147433-1 | 0.400 [10.16] |
| 147333-2 | 147433-2 | 0.410 [10.41] |
| 147333-3 | 147433-3 | 0.420 [10.67] |
| 147333-4 | 147433-4 | 0.430 [10.92] |
| 147333-5 | 147433-5 | 0.440 [11.18] |
| 147333-6 | 147433-6 | 0.450 [11.43] |
| 147333-7 | 147433-7 | 0.460 [11.68] |
| 147333-8 | 147433-8 | 0.470 [11.94] |
| 147333-9 | 147433-9 | 0.480 [12.19] |
| 1-147333-0 | 1-147433-0 | 0.490 [12.45] |
| 1-147333-1 | 1-147433-1 | 0.500 [12.70] |
| 1-147333-2 | 1-147433-2 | 0.510 [12.95] |
| 1-147333-3 | 1-147433-3 | 0.520 [13.21] |
| 1-147333-4 | 1-147433-4 | 0.530 [13.46] |
| 1-147333-5 | 1-147433-5 | 0.540 [13.72] |
| 1-147333-6 | 1-147433-6 | 0.550 [13.97] |
| 1-147333-7 | 1-147433-7 | 0.560 [14.22] |
| 1-147333-8 | 1-147433-8 | 0.570 [14.48] |
| 1-147333-9 | 1-147433-9 | 0.580 [14.73] |
| 2-147333-0 | 2-147433-0 | 0.590 [14.99] |
| 2-147333-1 | 2-147433-1 | 0.600 [15.24] |

| Part Number | | Description Post Length |
|-------------|------------------|----------------------------|
| Square | Square with Star | |
| 2-147333-2 | 2-147433-2 | 0.610 [15.49] |
| 2-147333-3 | 2-147433-3 | 0.620 [15.75] |
| 2-147333-4 | 2-147433-4 | 0.630 [16.00] |
| 2-147333-5 | 2-147433-5 | 0.640 [16.26] |
| 2-147333-6 | 2-147433-6 | 0.650 [16.51] |
| 2-147333-7 | 2-147433-7 | 0.660 [16.76] |
| 2-147333-8 | 2-147433-8 | 0.670 [17.02] |
| 2-147333-9 | 2-147433-9 | 0.680 [17.27] |
| 3-147333-0 | 3-147433-0 | 0.690 [17.53] |
| 3-147333-1 | 3-147433-1 | 0.700 [17.78] |
| 3-147333-2 | 3-147433-2 | 0.710 [18.03] |
| 3-147333-3 | 3-147433-3 | 0.720 [18.29] |
| 3-147333-4 | 3-147433-4 | 0.730 [18.54] |
| 3-147333-5 | 3-147433-5 | 0.740 [18.80] |
| 3-147333-6 | 3-147433-6 | 0.750 [19.05] |
| 3-147333-7 | 3-147433-7 | 0.760 [19.30] |
| 3-147333-8 | 3-147433-8 | 0.770 [19.56] |
| 3-147333-9 | 3-147433-9 | 0.780 [19.81] |
| 4-147333-0 | 4-147433-0 | 0.790 [20.07] |
| 4-147333-1 | 4-147433-1 | 0.800 [20.32] |
| 4-147333-2 | 4-147433-2 | 0.810 [20.57] |

| Part Number | | Description Post Length |
|-------------|------------------|----------------------------|
| Square | Square with Star | |
| 4-147333-3 | 4-147433-3 | 0.820 [20.83] |
| 4-147333-4 | 4-147433-4 | 0.830 [21.08] |
| 4-147333-5 | 4-147433-5 | 0.840 [21.34] |
| 4-147333-6 | 4-147433-6 | 0.850 [21.59] |
| 4-147333-7 | 4-147433-7 | 0.860 [21.84] |
| 4-147333-8 | 4-147433-8 | 0.870 [22.10] |
| 4-147333-9 | 4-147433-9 | 0.880 [22.35] |
| 5-147333-0 | 5-147433-0 | 0.890 [22.61] |
| 5-147333-1 | 5-147433-1 | 0.900 [22.86] |
| 5-147333-2 | 5-147433-2 | 0.910 [23.11] |
| 5-147333-3 | 5-147433-3 | 0.920 [23.37] |
| 5-147333-4 | 5-147433-4 | 0.930 [23.62] |
| 5-147333-5 | 5-147433-5 | 0.940 [23.88] |
| 5-147333-6 | 5-147433-6 | 0.950 [24.13] |
| 5-147333-7 | 5-147433-7 | 0.960 [24.38] |
| 5-147333-8 | 5-147433-8 | 0.970 [24.64] |
| 5-147333-9 | 5-147433-9 | 0.980 [24.89] |
| 6-147333-0 | 6-147433-0 | 0.990 [25.15] |
| 6-147333-1 | 6-147433-1 | 1.000 [25.40] |

Pre-Plated 15µ in. Gold

| Part Number | | Description Post Length |
|-------------|------------------|----------------------------|
| Square | Square with Star | |
| 147334-1 | 147434-1 | 0.400 [10.16] |
| 147334-2 | 147434-2 | 0.410 [10.41] |
| 147334-3 | 147434-3 | 0.420 [10.67] |
| 147334-4 | 147434-4 | 0.430 [10.92] |
| 147334-5 | 147434-5 | 0.440 [11.18] |
| 147334-6 | 147434-6 | 0.450 [11.43] |
| 147334-7 | 147434-7 | 0.460 [11.68] |
| 147334-8 | 147434-8 | 0.470 [11.94] |
| 147334-9 | 147434-9 | 0.480 [12.19] |
| 1-147334-0 | 1-147434-0 | 0.490 [12.45] |
| 1-147334-1 | 1-147434-1 | 0.500 [12.70] |
| 1-147334-2 | 1-147434-2 | 0.510 [12.95] |
| 1-147334-3 | 1-147434-3 | 0.520 [13.21] |
| 1-147334-4 | 1-147434-4 | 0.530 [13.46] |
| 1-147334-5 | 1-147434-5 | 0.540 [13.72] |
| 1-147334-6 | 1-147434-6 | 0.550 [13.97] |
| 1-147334-7 | 1-147434-7 | 0.560 [14.22] |
| 1-147334-8 | 1-147434-8 | 0.570 [14.48] |
| 1-147334-9 | 1-147434-9 | 0.580 [14.73] |
| 2-147334-0 | 2-147434-0 | 0.590 [14.99] |
| 2-147334-1 | 2-147434-1 | 0.600 [15.24] |

| Part Number | | Description Post Length |
|-------------|------------------|----------------------------|
| Square | Square with Star | |
| 2-147334-2 | 2-147434-2 | 0.610 [15.49] |
| 2-147334-3 | 2-147434-3 | 0.620 [15.75] |
| 2-147334-4 | 2-147434-4 | 0.630 [16.00] |
| 2-147334-5 | 2-147434-5 | 0.640 [16.26] |
| 2-147334-6 | 2-147434-6 | 0.650 [16.51] |
| 2-147334-7 | 2-147434-7 | 0.660 [16.76] |
| 2-147334-8 | 2-147434-8 | 0.670 [17.02] |
| 2-147334-9 | 2-147434-9 | 0.680 [17.27] |
| 3-147334-0 | 3-147434-0 | 0.690 [17.53] |
| 3-147334-1 | 3-147434-1 | 0.700 [17.78] |
| 3-147334-2 | 3-147434-2 | 0.710 [18.03] |
| 3-147334-3 | 3-147434-3 | 0.720 [18.29] |
| 3-147334-4 | 3-147434-4 | 0.730 [18.54] |
| 3-147334-5 | 3-147434-5 | 0.740 [18.80] |
| 3-147334-6 | 3-147434-6 | 0.750 [19.05] |
| 3-147334-7 | 3-147434-7 | 0.760 [19.30] |
| 3-147334-8 | 3-147434-8 | 0.770 [19.56] |
| 3-147334-9 | 3-147434-9 | 0.780 [19.81] |
| 4-147334-0 | 4-147434-0 | 0.790 [20.07] |
| 4-147334-1 | 4-147434-1 | 0.800 [20.32] |
| 4-147334-2 | 4-147434-2 | 0.810 [20.57] |

| Part Number | | Description Post Length |
|-------------|------------------|----------------------------|
| Square | Square with Star | |
| 4-147334-3 | 4-147434-3 | 0.820 [20.83] |
| 4-147334-4 | 4-147434-4 | 0.830 [21.08] |
| 4-147334-5 | 4-147434-5 | 0.840 [21.34] |
| 4-147334-6 | 4-147434-6 | 0.850 [21.59] |
| 4-147334-7 | 4-147434-7 | 0.860 [21.84] |
| 4-147334-8 | 4-147434-8 | 0.870 [22.10] |
| 4-147334-9 | 4-147434-9 | 0.880 [22.35] |
| 5-147334-0 | 5-147434-0 | 0.890 [22.61] |
| 5-147334-1 | 5-147434-1 | 0.900 [22.86] |
| 5-147334-2 | 5-147434-2 | 0.910 [23.11] |
| 5-147334-3 | 5-147434-3 | 0.920 [23.37] |
| 5-147334-4 | 5-147434-4 | 0.930 [23.62] |
| 5-147334-5 | 5-147434-5 | 0.940 [23.88] |
| 5-147334-6 | 5-147434-6 | 0.950 [24.13] |
| 5-147334-7 | 5-147434-7 | 0.960 [24.38] |
| 5-147334-8 | 5-147434-8 | 0.970 [24.64] |
| 5-147334-9 | 5-147434-9 | 0.980 [24.89] |
| 6-147334-0 | 6-147434-0 | 0.990 [25.15] |
| 6-147334-1 | 6-147434-1 | 1.000 [25.40] |

Pre-Plated 30µ in. Gold

| Part Number | | Description Post Length |
|-------------|------------------|----------------------------|
| Square | Square with Star | |
| 147335-1 | 147435-1 | 0.400 [10.16] |
| 147335-2 | 147435-2 | 0.410 [10.41] |
| 147335-3 | 147435-3 | 0.420 [10.67] |
| 147335-4 | 147435-4 | 0.430 [10.92] |
| 147335-5 | 147435-5 | 0.440 [11.18] |
| 147335-6 | 147435-6 | 0.450 [11.43] |
| 147335-7 | 147435-7 | 0.460 [11.68] |
| 147335-8 | 147435-8 | 0.470 [11.94] |
| 147335-9 | 147435-9 | 0.480 [12.19] |
| 1-147335-0 | 1-147435-0 | 0.490 [12.45] |
| 1-147335-1 | 1-147435-1 | 0.500 [12.70] |
| 1-147335-2 | 1-147435-2 | 0.510 [12.95] |
| 1-147335-3 | 1-147435-3 | 0.520 [13.21] |
| 1-147335-4 | 1-147435-4 | 0.530 [13.46] |
| 1-147335-5 | 1-147435-5 | 0.540 [13.72] |
| 1-147335-6 | 1-147435-6 | 0.550 [13.97] |
| 1-147335-7 | 1-147435-7 | 0.560 [14.22] |
| 1-147335-8 | 1-147435-8 | 0.570 [14.48] |
| 1-147335-9 | 1-147435-9 | 0.580 [14.73] |
| 2-147335-0 | 2-147435-0 | 0.590 [14.99] |
| 2-147335-1 | 2-147435-1 | 0.600 [15.24] |

| Part Number | | Description Post Length |
|-------------|------------------|----------------------------|
| Square | Square with Star | |
| 2-147335-2 | 2-147435-2 | 0.610 [15.49] |
| 2-147335-3 | 2-147435-3 | 0.620 [15.75] |
| 2-147335-4 | 2-147435-4 | 0.630 [16.00] |
| 2-147335-5 | 2-147435-5 | 0.640 [16.26] |
| 2-147335-6 | 2-147435-6 | 0.650 [16.51] |
| 2-147335-7 | 2-147435-7 | 0.660 [16.76] |
| 2-147335-8 | 2-147435-8 | 0.670 [17.02] |
| 2-147335-9 | 2-147435-9 | 0.680 [17.27] |
| 3-147335-0 | 3-147435-0 | 0.690 [17.53] |
| 3-147335-1 | 3-147435-1 | 0.700 [17.78] |
| 3-147335-2 | 3-147435-2 | 0.710 [18.03] |
| 3-147335-3 | 3-147435-3 | 0.720 [18.29] |
| 3-147335-4 | 3-147435-4 | 0.730 [18.54] |
| 3-147335-5 | 3-147435-5 | 0.740 [18.80] |
| 3-147335-6 | 3-147435-6 | 0.750 [19.05] |
| 3-147335-7 | 3-147435-7 | 0.760 [19.30] |
| 3-147335-8 | 3-147435-8 | 0.770 [19.56] |
| 3-147335-9 | 3-147435-9 | 0.780 [19.81] |
| 4-147335-0 | 4-147435-0 | 0.790 [20.07] |
| 4-147335-1 | 4-147435-1 | 0.800 [20.32] |
| 4-147335-2 | 4-147435-2 | 0.810 [20.57] |

| Part Number | | Description Post Length |
|-------------|------------------|----------------------------|
| Square | Square with Star | |
| 4-147335-3 | 4-147435-3 | 0.820 [20.83] |
| 4-147335-4 | 4-147435-4 | 0.830 [21.08] |
| 4-147335-5 | 4-147435-5 | 0.840 [21.34] |
| 4-147335-6 | 4-147435-6 | 0.850 [21.59] |
| 4-147335-7 | 4-147435-7 | 0.860 [21.84] |
| 4-147335-8 | 4-147435-8 | 0.870 [22.10] |
| 4-147335-9 | 4-147435-9 | 0.880 [22.35] |
| 5-147335-0 | 5-147435-0 | 0.890 [22.61] |
| 5-147335-1 | 5-147435-1 | 0.900 [22.86] |
| 5-147335-2 | 5-147435-2 | 0.910 [23.11] |
| 5-147335-3 | 5-147435-3 | 0.920 [23.37] |
| 5-147335-4 | 5-147435-4 | 0.930 [23.62] |
| 5-147335-5 | 5-147435-5 | 0.940 [23.88] |
| 5-147335-6 | 5-147435-6 | 0.950 [24.13] |
| 5-147335-7 | 5-147435-7 | 0.960 [24.38] |
| 5-147335-8 | 5-147435-8 | 0.970 [24.64] |
| 5-147335-9 | 5-147435-9 | 0.980 [24.89] |
| 6-147335-0 | 6-147435-0 | 0.990 [25.15] |
| 6-147335-1 | 6-147435-1 | 1.000 [25.40] |

Note: All part numbers are RoHS compliant.



AMPMODU .045 [1.14] Square Continuous Posts

Features of .045 [1.14] Square Continuous Posts

- Brass drawn wire for posts
- .400 to 1.000 [10.16 to 25.40] overall pin length (.010 [0.25] increments)
- Plating Options:
 - Tin
 - 15µ in. gold
 - 30µ in. gold
- Star feature also available

Benefits

- Less expensive than bandolier style posts
- Can be placed on printed circuit boards at any desired centerline
- Less scrap material (no carrier strip)

Technical Documents — page 276
Application Specification
 114-13011

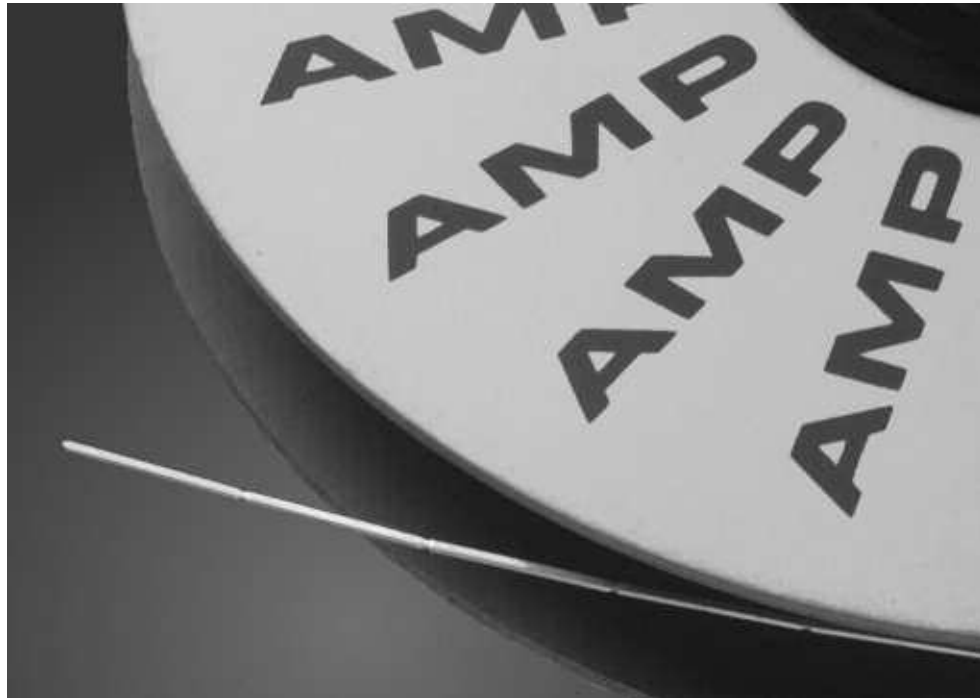

TE now offers AMPMODU .045 [1.14] Square Continuous Posts. These posts can be used instead of the original posts that come on a bandolier style carrier strip. These posts are on a reel, but the posts are 'notched' at the desired length (no carrier strip is needed). This feature allows more versatility by providing post lengths from .400 to 1.000 [10.16 to 25.40], available in increments of .010 [0.25].

The posts are brass drawn wire and are inserted into a printed circuit board via application tooling at any centerline configuration. They can be used for wire wrap applications or mated to a receptacle.

Potential industries include: building systems, commercial/home equipment, household appliances, home power tools and equipment.

The current rating is 7 amps. The posts are available plated with tin, 15µ in. gold, or 30µ in. gold. Other platings are available upon request.

TE application tooling is a modular head (Part Number 904640-1) placed on the Modular Insertion System Bench Machine (Part Number 217600-1.)

Note: All part numbers are RoHS compliant.

AMPMODU .045 [1.14] Square Continuous Posts (Continued)

Pre-Plated Tin

| Part Number | | Description Post Length |
|-------------|------------------|----------------------------|
| Square | Square with Star | |
| 147070-1 | 147436-1 | 0.400 [10.16] |
| 147070-2 | 147436-2 | 0.410 [10.41] |
| 147070-3 | 147436-3 | 0.420 [10.67] |
| 147070-4 | 147436-4 | 0.430 [10.92] |
| 147070-5 | 147436-5 | 0.440 [11.18] |
| 147070-6 | 147436-6 | 0.450 [11.43] |
| 147070-7 | 147436-7 | 0.460 [11.68] |
| 147070-8 | 147436-8 | 0.470 [11.94] |
| 147070-9 | 147436-9 | 0.480 [12.19] |
| 1-147070-0 | 1-147436-0 | 0.490 [12.45] |
| 1-147070-1 | 1-147436-1 | 0.500 [12.70] |
| 1-147070-2 | 1-147436-2 | 0.510 [12.95] |
| 1-147070-3 | 1-147436-3 | 0.520 [13.21] |
| 1-147070-4 | 1-147436-4 | 0.530 [13.46] |
| 1-147070-5 | 1-147436-5 | 0.540 [13.72] |
| 1-147070-6 | 1-147436-6 | 0.550 [13.97] |
| 1-147070-7 | 1-147436-7 | 0.560 [14.22] |
| 1-147070-8 | 1-147436-8 | 0.570 [14.48] |
| 1-147070-9 | 1-147436-9 | 0.580 [14.73] |
| 2-147070-0 | 2-147436-0 | 0.590 [14.99] |
| 2-147070-1 | 2-147436-1 | 0.600 [15.24] |

| Part Number | | Description Post Length |
|-------------|------------------|----------------------------|
| Square | Square with Star | |
| 2-147070-2 | 2-147436-2 | 0.610 [15.49] |
| 2-147070-3 | 2-147436-3 | 0.620 [15.75] |
| 2-147070-4 | 2-147436-4 | 0.630 [16.00] |
| 2-147070-5 | 2-147436-5 | 0.640 [16.26] |
| 2-147070-6 | 2-147436-6 | 0.650 [16.51] |
| 2-147070-7 | 2-147436-7 | 0.660 [16.76] |
| 2-147070-8 | 2-147436-8 | 0.670 [17.02] |
| 2-147070-9 | 2-147436-9 | 0.680 [17.27] |
| 3-147070-0 | 3-147436-0 | 0.690 [17.53] |
| 3-147070-1 | 3-147436-1 | 0.700 [17.78] |
| 3-147070-2 | 3-147436-2 | 0.710 [18.03] |
| 3-147070-3 | 3-147436-3 | 0.720 [18.29] |
| 3-147070-4 | 3-147436-4 | 0.730 [18.54] |
| 3-147070-5 | 3-147436-5 | 0.740 [18.80] |
| 3-147070-6 | 3-147436-6 | 0.750 [19.05] |
| 3-147070-7 | 3-147436-7 | 0.760 [19.30] |
| 3-147070-8 | 3-147436-8 | 0.770 [19.56] |
| 3-147070-9 | 3-147436-9 | 0.780 [19.81] |
| 4-147070-0 | 4-147436-0 | 0.790 [20.07] |
| 4-147070-1 | 4-147436-1 | 0.800 [20.32] |
| 4-147070-2 | 4-147436-2 | 0.810 [20.57] |

| Part Number | | Description Post Length |
|-------------|------------------|----------------------------|
| Square | Square with Star | |
| 4-147070-3 | 4-147436-3 | 0.820 [20.83] |
| 4-147070-4 | 4-147436-4 | 0.830 [21.08] |
| 4-147070-5 | 4-147436-5 | 0.840 [21.34] |
| 4-147070-6 | 4-147436-6 | 0.850 [21.59] |
| 4-147070-7 | 4-147436-7 | 0.860 [21.84] |
| 4-147070-8 | 4-147436-8 | 0.870 [22.10] |
| 4-147070-9 | 4-147436-9 | 0.880 [22.35] |
| 5-147070-0 | 5-147436-0 | 0.890 [22.61] |
| 5-147070-1 | 5-147436-1 | 0.900 [22.86] |
| 5-147070-2 | 5-147436-2 | 0.910 [23.11] |
| 5-147070-3 | 5-147436-3 | 0.920 [23.37] |
| 5-147070-4 | 5-147436-4 | 0.930 [23.62] |
| 5-147070-5 | 5-147436-5 | 0.940 [23.88] |
| 5-147070-6 | 5-147436-6 | 0.950 [24.13] |
| 5-147070-7 | 5-147436-7 | 0.960 [24.38] |
| 5-147070-8 | 5-147436-8 | 0.970 [24.64] |
| 5-147070-9 | 5-147436-9 | 0.980 [24.89] |
| 6-147070-0 | 6-147436-0 | 0.990 [25.15] |
| 6-147070-1 | 6-147436-1 | 1.000 [25.40] |

Pre-Plated 15µ in. Gold

| Part Number | | Description Post Length |
|-------------|------------------|----------------------------|
| Square | Square with Star | |
| 147071-1 | 147437-1 | 0.400 [10.16] |
| 147071-2 | 147437-2 | 0.410 [10.41] |
| 147071-3 | 147437-3 | 0.420 [10.67] |
| 147071-4 | 147437-4 | 0.430 [10.92] |
| 147071-5 | 147437-5 | 0.440 [11.18] |
| 147071-6 | 147437-6 | 0.450 [11.43] |
| 147071-7 | 147437-7 | 0.460 [11.68] |
| 147071-8 | 147437-8 | 0.470 [11.94] |
| 147071-9 | 147437-9 | 0.480 [12.19] |
| 1-147071-0 | 1-147437-0 | 0.490 [12.45] |
| 1-147071-1 | 1-147437-1 | 0.500 [12.70] |
| 1-147071-2 | 1-147437-2 | 0.510 [12.95] |
| 1-147071-3 | 1-147437-3 | 0.520 [13.21] |
| 1-147071-4 | 1-147437-4 | 0.530 [13.46] |
| 1-147071-5 | 1-147437-5 | 0.540 [13.72] |
| 1-147071-6 | 1-147437-6 | 0.550 [13.97] |
| 1-147071-7 | 1-147437-7 | 0.560 [14.22] |
| 1-147071-8 | 1-147437-8 | 0.570 [14.48] |
| 1-147071-9 | 1-147437-9 | 0.580 [14.73] |
| 2-147071-0 | 2-147437-0 | 0.590 [14.99] |
| 2-147071-1 | 2-147437-1 | 0.600 [15.24] |

| Part Number | | Description Post Length |
|-------------|------------------|----------------------------|
| Square | Square with Star | |
| 2-147071-2 | 2-147437-2 | 0.610 [15.49] |
| 2-147071-3 | 2-147437-3 | 0.620 [15.75] |
| 2-147071-4 | 2-147437-4 | 0.630 [16.00] |
| 2-147071-5 | 2-147437-5 | 0.640 [16.26] |
| 2-147071-6 | 2-147437-6 | 0.650 [16.51] |
| 2-147071-7 | 2-147437-7 | 0.660 [16.76] |
| 2-147071-8 | 2-147437-8 | 0.670 [17.02] |
| 2-147071-9 | 2-147437-9 | 0.680 [17.27] |
| 3-147071-0 | 3-147437-0 | 0.690 [17.53] |
| 3-147071-1 | 3-147437-1 | 0.700 [17.78] |
| 3-147071-2 | 3-147437-2 | 0.710 [18.03] |
| 3-147071-3 | 3-147437-3 | 0.720 [18.29] |
| 3-147071-4 | 3-147437-4 | 0.730 [18.54] |
| 3-147071-5 | 3-147437-5 | 0.740 [18.80] |
| 3-147071-6 | 3-147437-6 | 0.750 [19.05] |
| 3-147071-7 | 3-147437-7 | 0.760 [19.30] |
| 3-147071-8 | 3-147437-8 | 0.770 [19.56] |
| 3-147071-9 | 3-147437-9 | 0.780 [19.81] |
| 4-147071-0 | 4-147437-0 | 0.790 [20.07] |
| 4-147071-1 | 4-147437-1 | 0.800 [20.32] |
| 4-147071-2 | 4-147437-2 | 0.810 [20.57] |

| Part Number | | Description Post Length |
|-------------|------------------|----------------------------|
| Square | Square with Star | |
| 4-147071-3 | 4-147437-3 | 0.820 [20.83] |
| 4-147071-4 | 4-147437-4 | 0.830 [21.08] |
| 4-147071-5 | 4-147437-5 | 0.840 [21.34] |
| 4-147071-6 | 4-147437-6 | 0.850 [21.59] |
| 4-147071-7 | 4-147437-7 | 0.860 [21.84] |
| 4-147071-8 | 4-147437-8 | 0.870 [22.10] |
| 4-147071-9 | 4-147437-9 | 0.880 [22.35] |
| 5-147071-0 | 5-147437-0 | 0.890 [22.61] |
| 5-147071-1 | 5-147437-1 | 0.900 [22.86] |
| 5-147071-2 | 5-147437-2 | 0.910 [23.11] |
| 5-147071-3 | 5-147437-3 | 0.920 [23.37] |
| 5-147071-4 | 5-147437-4 | 0.930 [23.62] |
| 5-147071-5 | 5-147437-5 | 0.940 [23.88] |
| 5-147071-6 | 5-147437-6 | 0.950 [24.13] |
| 5-147071-7 | 5-147437-7 | 0.960 [24.38] |
| 5-147071-8 | 5-147437-8 | 0.970 [24.64] |
| 5-147071-9 | 5-147437-9 | 0.980 [24.89] |
| 6-147071-0 | 6-147437-0 | 0.990 [25.15] |
| 6-147071-1 | 6-147437-1 | 1.000 [25.40] |

Pre-Plated 30µ in. Gold

| Part Number | | Description Post Length |
|-------------|------------------|----------------------------|
| Square | Square with Star | |
| 147072-1 | 147438-1 | 0.400 [10.16] |
| 147072-2 | 147438-2 | 0.410 [10.41] |
| 147072-3 | 147438-3 | 0.420 [10.67] |
| 147072-4 | 147438-4 | 0.430 [10.92] |
| 147072-5 | 147438-5 | 0.440 [11.18] |
| 147072-6 | 147438-6 | 0.450 [11.43] |
| 147072-7 | 147438-7 | 0.460 [11.68] |
| 147072-8 | 147438-8 | 0.470 [11.94] |
| 147072-9 | 147438-9 | 0.480 [12.19] |
| 1-147072-0 | 1-147438-0 | 0.490 [12.45] |
| 1-147072-1 | 1-147438-1 | 0.500 [12.70] |
| 1-147072-2 | 1-147438-2 | 0.510 [12.95] |
| 1-147072-3 | 1-147438-3 | 0.520 [13.21] |
| 1-147072-4 | 1-147438-4 | 0.530 [13.46] |
| 1-147072-5 | 1-147438-5 | 0.540 [13.72] |
| 1-147072-6 | 1-147438-6 | 0.550 [13.97] |
| 1-147072-7 | 1-147438-7 | 0.560 [14.22] |
| 1-147072-8 | 1-147438-8 | 0.570 [14.48] |
| 1-147072-9 | 1-147438-9 | 0.580 [14.73] |
| 2-147072-0 | 2-147438-0 | 0.590 [14.99] |
| 2-147072-1 | 2-147438-1 | 0.600 [15.24] |

| Part Number | | Description Post Length |
|-------------|------------------|----------------------------|
| Square | Square with Star | |
| 2-147072-2 | 2-147438-2 | 0.610 [15.49] |
| 2-147072-3 | 2-147438-3 | 0.620 [15.75] |
| 2-147072-4 | 2-147438-4 | 0.630 [16.00] |
| 2-147072-5 | 2-147438-5 | 0.640 [16.26] |
| 2-147072-6 | 2-147438-6 | 0.650 [16.51] |
| 2-147072-7 | 2-147438-7 | 0.660 [16.76] |
| 2-147072-8 | 2-147438-8 | 0.670 [17.02] |
| 2-147072-9 | 2-147438-9 | 0.680 [17.27] |
| 3-147072-0 | 3-147438-0 | 0.690 [17.53] |
| 3-147072-1 | 3-147438-1 | 0.700 [17.78] |
| 3-147072-2 | 3-147438-2 | 0.710 [18.03] |
| 3-147072-3 | 3-147438-3 | 0.720 [18.29] |
| 3-147072-4 | 3-147438-4 | 0.730 [18.54] |
| 3-147072-5 | 3-147438-5 | 0.740 [18.80] |
| 3-147072-6 | 3-147438-6 | 0.750 [19.05] |
| 3-147072-7 | 3-147438-7 | 0.760 [19.30] |
| 3-147072-8 | 3-147438-8 | 0.770 [19.56] |
| 3-147072-9 | 3-147438-9 | 0.780 [19.81] |
| 4-147072-0 | 4-147438-0 | 0.790 [20.07] |
| 4-147072-1 | 4-147438-1 | 0.800 [20.32] |
| 4-147072-2 | 4-147438-2 | 0.810 [20.57] |

| Part Number | | Description Post Length |
|-------------|------------------|----------------------------|
| Square | Square with Star | |
| 4-147072-3 | 4-147438-3 | 0.820 [20.83] |
| 4-147072-4 | 4-147438-4 | 0.830 [21.08] |
| 4-147072-5 | 4-147438-5 | 0.840 [21.34] |
| 4-147072-6 | 4-147438-6 | 0.850 [21.59] |
| 4-147072-7 | 4-147438-7 | 0.860 [21.84] |
| 4-147072-8 | 4-147438-8 | 0.870 [22.10] |
| 4-147072-9 | 4-147438-9 | 0.880 [22.35] |
| 5-147072-0 | 5-147438-0 | 0.890 [22.61] |
| 5-147072-1 | 5-147438-1 | 0.900 [22.86] |
| 5-147072-2 | 5-147438-2 | 0.910 [23.11] |
| 5-147072-3 | 5-147438-3 | 0.920 [23.37] |
| 5-147072-4 | 5-147438-4 | 0.930 [23.62] |
| 5-147072-5 | 5-147438-5 | 0.940 [23.88] |
| 5-147072-6 | 5-147438-6 | 0.950 [24.13] |
| 5-147072-7 | 5-147438-7 | 0.960 [24.38] |
| 5-147072-8 | 5-147438-8 | 0.970 [24.64] |
| 5-147072-9 | 5-147438-9 | 0.980 [24.89] |
| 6-147072-0 | 6-147438-0 | 0.990 [25.15] |
| 6-147072-1 | 6-147438-1 | 1.000 [25.40] |

Note: All part numbers are RoHS compliant.



Receptacle Assemblies, Horizontal Mount

Product Facts

- All receptacle assemblies are end stackable
- Contact design employs dual cantilever beams with built-in anti-overstress feature
- Closed entry housings help prevent post stubbing
- Wide range of sizes available
- Other versions available upon request
- Housings made of high temperature, surface mount compatible thermoplastic material, 94V-0 rated
- Duplex gold and matte tin plated contacts have full nickel underplate
- Housings feature PC board standoffs
- Solder tails accommodate a PC board thickness of .062 [1.57]
- Recognized under the Component Program of Underwriters Laboratories Inc., File No. E28476
- Certified by Canadian Standards Association, File No. LR 7189

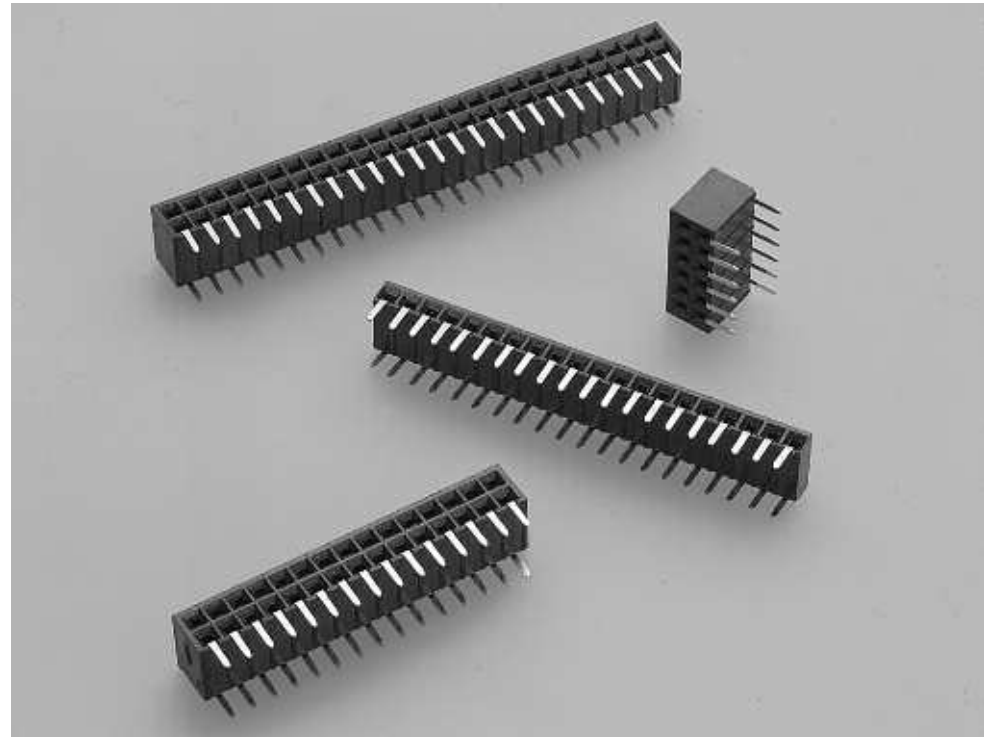

Horizontal Mount receptacle assemblies are designed to reliably and economically meet the packaging and interconnection requirements of today's electronics industry, generally for applications using the mother/daughter board arrangement.

This product line is offered in both single and double row configurations. The .100 [2.54] centerline

assemblies are available in a wide range of position sizes. They have end stacking capability which gives the added advantage of flexibility.

The housings are made of high temperature, surface mount compatible thermoplastic material that is 94V-0 rated. Contacts are phosphor bronze, fully underplated with nickel to help prevent corrosion and are available in three plating options.

The receptacle contact is an established proven design with a fully enclosed, one-piece "box" to protect the contact area. In addition, the receptacle contact has dual cantilever beams with a built-in anti-overstress feature. Standard solder tails accommodate a board thickness of .062 [1.57].

Performance Characteristics

Mechanical Characteristics

Mating Force — 6.0 oz. [1.67N] per contact (max.)

Unmating Force — .75 oz. [0.21N] per contact (min.) during third mating cycle

Durability — 200 cycles

Environmental Characteristics

Operating Temperature — -65°C to +125°C

Electrical Characteristics

Current Rating — 3.0 amperes (max.) for single contact; 2.0 amperes (max.) per contact when connector is fully energized

Contact Resistance — 12 milliohms (max.)

Insulation Resistance — 5000 megohms (min.) between adjacent contacts

Dielectric Withstanding Voltage (at sea level) — 750 V rms

Mod II Receptacle Assemblies, Single-Row, .100 [2.54] Centerline

Closed Entry, End Stackable, Short Point-of-Contact, with Standoffs



Material and Finish

Housing — Glass-filled thermoplastic, black, 94V-0 rated

Contacts — Phosphor bronze, plated as follows:

Plating A — Duplex .000030 [0.00076] gold on contact area, .000150-.000300 [0.00381-0.00762] matte tin on solder area all over .000050 [0.00127] nickel

Plating B — Duplex .000010 [0.000254] gold on contact area, .000150-.000300 [0.00381-0.00762] matte tin on solder area all over .000050 [0.00127] nickel

Plating C — .000150-.000300 [0.00381-0.00762] matte tin on solder leads, all over .000050 [0.00127] nickel

Related Product Data

Mateable Headers — Refer to the Mating Post Selection Guide — page 90

Performance Characteristics — page 168

Technical Documents — page 276

Product Specification
108-25026

Application Specification
114-25018

Additional receptacle assembly sizes are available; minimum order quantities may apply. Consult TE.

Keying Plug



Part No. 86286-1
(Plugs into receptacle contact)

Material — Natural color nylon

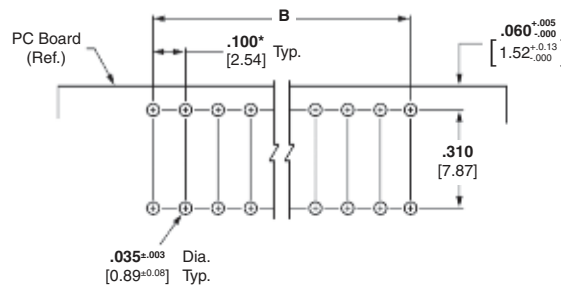
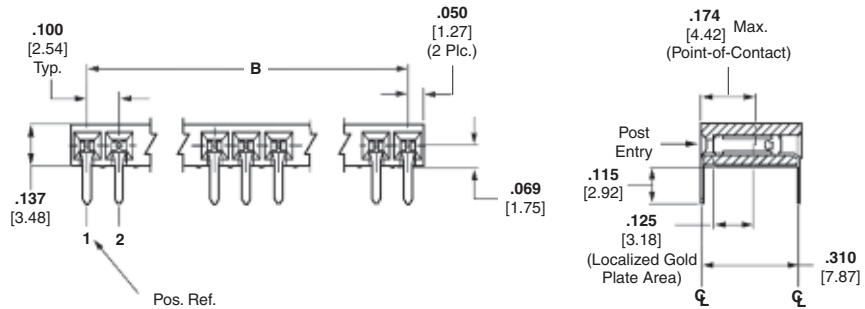
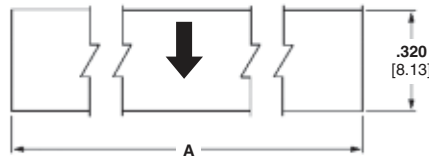

Recommended PC Board Hole Layout
(for .062 [1.57] thick PC board)

*±.003 [±0.08] tolerances not to accumulate within one connector pattern.

| No. of Pos. | Dimensions | | Contact Plating/Part Nos. | | |
|-------------|----------------|---------------|---------------------------|-------------|-------------|
| | A | B | Plating A | Plating B | Plating C |
| 2 | .200 [5.08] | .100 [2.54] | 5535676-1 | 5146139-1 | 5535677-1 |
| 3 | .300 [7.62] | .200 [5.08] | 5535676-2 | 5146139-2 | 5535677-2 |
| 4 | .400 [10.16] | .300 [7.62] | 5535676-3 | 5146139-3 | 5535677-3 |
| 5 | .500 [12.70] | .400 [10.16] | 5535676-4 | 5146139-4 | 5535677-4 |
| 6 | .600 [15.24] | .500 [12.70] | 5535676-5 | 5146139-5 | 5535677-5 |
| 7 | .700 [17.78] | .600 [15.24] | 5535676-6 | 5146139-6 | 5535677-6 |
| 8 | .800 [20.32] | .700 [17.78] | 5535676-7 | 5146139-7 | 5535677-7 |
| 9 | .900 [22.86] | .800 [20.32] | 5535676-8 | 5146139-8 | 5535677-8 |
| 10 | 1.000 [25.40] | .900 [22.86] | 5535676-9 | 5146139-9 | 5535677-9 |
| 11 | 1.100 [27.94] | 1.000 [25.40] | 1-5535676-0 | 1-5146139-0 | 1-5535677-0 |
| 12 | 1.200 [30.48] | 1.100 [27.94] | 1-5535676-1 | 1-5146139-1 | 1-5535677-1 |
| 13 | 1.300 [33.02] | 1.200 [30.48] | 1-5535676-2 | 1-5146139-2 | 1-5535677-2 |
| 14 | 1.400 [35.56] | 1.300 [33.02] | 1-5535676-3 | 1-5146139-3 | 1-5535677-3 |
| 15 | 1.500 [38.10] | 1.400 [35.56] | 1-5535676-4 | 1-5146139-4 | 1-5535677-4 |
| 16 | 1.600 [40.64] | 1.500 [38.10] | 1-5535676-5 | 1-5146139-5 | 1-5535677-5 |
| 17 | 1.700 [43.18] | 1.600 [40.64] | 1-5535676-6 | 1-5146139-6 | 1-5535677-6 |
| 18 | 1.800 [45.72] | 1.700 [43.18] | 1-5535676-7 | 1-5146139-7 | 1-5535677-7 |
| 19 | 1.900 [48.26] | 1.800 [45.72] | 1-5535676-8 | 1-5146139-8 | 1-5535677-8 |
| 20 | 2.000 [50.80] | 1.900 [48.26] | 1-5535676-9 | 1-5146139-9 | 1-5535677-9 |
| 30 | 3.000 [76.20] | 2.900 [73.66] | 2-5535676-9 | 2-5146139-9 | 2-5535677-9 |
| 40 | 4.000 [101.60] | 3.900 [99.06] | 3-5535676-9 | 3-5146139-9 | 3-5535677-9 |

Note: 1. TE recommends mating gold or duplex plated headers with duplex plated receptacle assemblies.

Note: All part numbers are RoHS compliant.

Mod II Receptacle Assemblies, Double-Row, .100 x .100 [2.54 x 2.54] Centerlines

Closed Entry, End Stackable, Short Point-of-Contact, with Standoffs

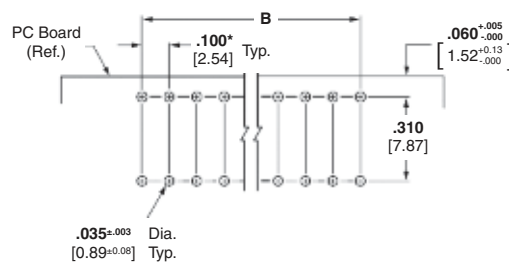
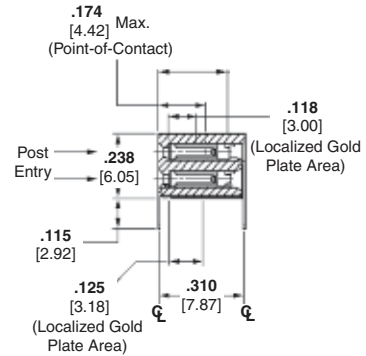
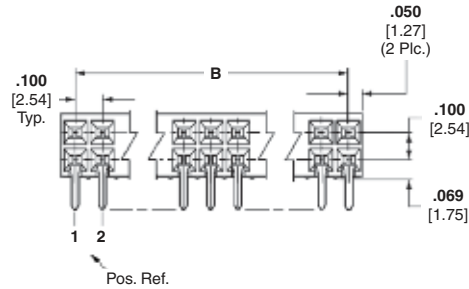
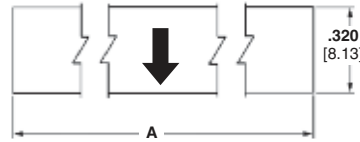
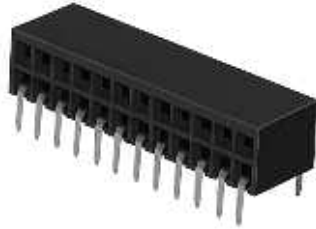

Recommended PC Board Hole Layout (for .062 [1.57] thick PC board)

*±.003 [±0.08] tolerances not to accumulate within one connector pattern.

Material and Finish

Housing — Glass-filled thermoplastic, black, 94V-0 rated

Contacts — Phosphor bronze, plated as follows:

Plating A — Duplex .000030 [0.00076] gold on contact area, .000150-.000300 [0.00381-0.00762] matte tin on solder area all over .000050 [0.00127] nickel

Plating B — Duplex .000010 [0.000254] gold on contact area, .000150-.000300 [0.00381-0.00762] matte tin on solder area all over .000050 [0.00127] nickel

Plating C — .000150-.000300 [0.00381-0.00762] matte tin on solder leads, all over .000050 [0.00127] nickel

Related Product Data

Mateable Headers — Refer to the Mating Post Selection Guide — page 90

Performance Characteristics — page 168

Technical Documents — page 276

Product Specification 108-25026

Application Specification 114-25018

Additional receptacle assembly sizes are available; minimum order quantities may apply. Consult TE.

| No. of Pos. | Dimensions | | Contact Plating/Part Nos. | | |
|-------------|---------------|---------------|---------------------------|-------------|-------------|
| | A | B | Plating A | Plating B | Plating C |
| 4 | .200 [5.08] | .100 [2.54] | 6-5535512-1 | 5146140-1 | 6-5102084-4 |
| 6 | .300 [7.62] | .200 [5.08] | 6-5535512-2 | 5146140-2 | 6-5102084-3 |
| 8 | .400 [10.16] | .300 [7.62] | 6-5535512-3 | 5146140-3 | 6-5102084-2 |
| 10 | .500 [12.70] | .400 [10.16] | 6-5535512-4 | 5146140-4 | 6-5102084-1 |
| 12 | .600 [15.24] | .500 [12.70] | 5535512-1 | 5146140-5 | 6-5102084-0 |
| 14 | .700 [17.78] | .600 [15.24] | 1-5535512-7 | 5146140-6 | 5-5102084-9 |
| 16 | .800 [20.32] | .700 [17.78] | 1-5535512-8 | 5146140-7 | 5-5102084-8 |
| 18 | .900 [22.86] | .800 [20.32] | 1-5535512-6 | 5146140-8 | 5-5102084-7 |
| 20 | 1.000 [25.40] | .900 [22.86] | 5535512-2 | 5146140-9 | 5-5102084-6 |
| 22 | 1.100 [27.94] | 1.000 [25.40] | 1-5535512-9 | 1-5146140-0 | 5-5102084-5 |
| 24 | 1.200 [30.48] | 1.100 [27.94] | 5535512-3 | 1-5146140-1 | 5-5102084-4 |
| 26 | 1.300 [33.02] | 1.200 [30.48] | 2-5535512-0 | 1-5146140-2 | 5-5102084-3 |
| 28 | 1.400 [35.56] | 1.300 [33.02] | 2-5535512-1 | 1-5146140-3 | 5-5102084-2 |
| 30 | 1.500 [38.10] | 1.400 [35.56] | 2-5535512-2 | 1-5146140-4 | 5-5102084-1 |
| 32 | 1.600 [40.64] | 1.500 [38.10] | 2-5535512-3 | 1-5146140-5 | 5-5102084-0 |
| 34 | 1.700 [43.18] | 1.600 [40.64] | 5535512-4 | 1-5146140-6 | 4-5102084-9 |
| 36 | 1.800 [45.72] | 1.700 [43.18] | 5535512-5 | 1-5146140-7 | 4-5102084-8 |
| 38 | 1.900 [48.26] | 1.800 [45.72] | 2-5535512-4 | 1-5146140-8 | 4-5102084-7 |
| 40 | 2.000 [50.80] | 1.900 [48.26] | 2-5535512-5 | 1-5146140-9 | 4-5102084-6 |
| 50 | 2.500 [63.50] | 2.400 [60.96] | 5535512-7 | 2-5146140-0 | 4-5102084-1 |
| 60 | 3.000 [76.20] | 2.900 [73.66] | 3-5535512-0 | 2-5146140-1 | 3-5102084-6 |

Notes: 1. TE recommends mating gold or duplex plated headers with duplex plated receptacle assemblies.
2. .256 [6.50] minimum positive pin stop to prevent shorting between row.

Note: All part numbers are RoHS compliant.

Mod II Surface Mount Horizontal Receptacle Assemblies, .100 x .100 [2.54 x 2.54] Centerline

Product Facts

- Surface mount leads
- All receptacle assemblies are end stackable
- Contact design employs dual cantilever beams with built-in anti-overstress feature
- Closed entry housings help prevent post stubbing
- Housings made of high temperature, surface mount compatible thermoplastic material, 94 V-0 rated
- Duplex gold and matte tin plated contacts have full nickel underplate
- Housings feature PC board standoffs
- Recognized under the Component Program of Underwriters Laboratories Inc., File No. E28476 
- Certified by Canadian Standards Association, File No. LR 7189 

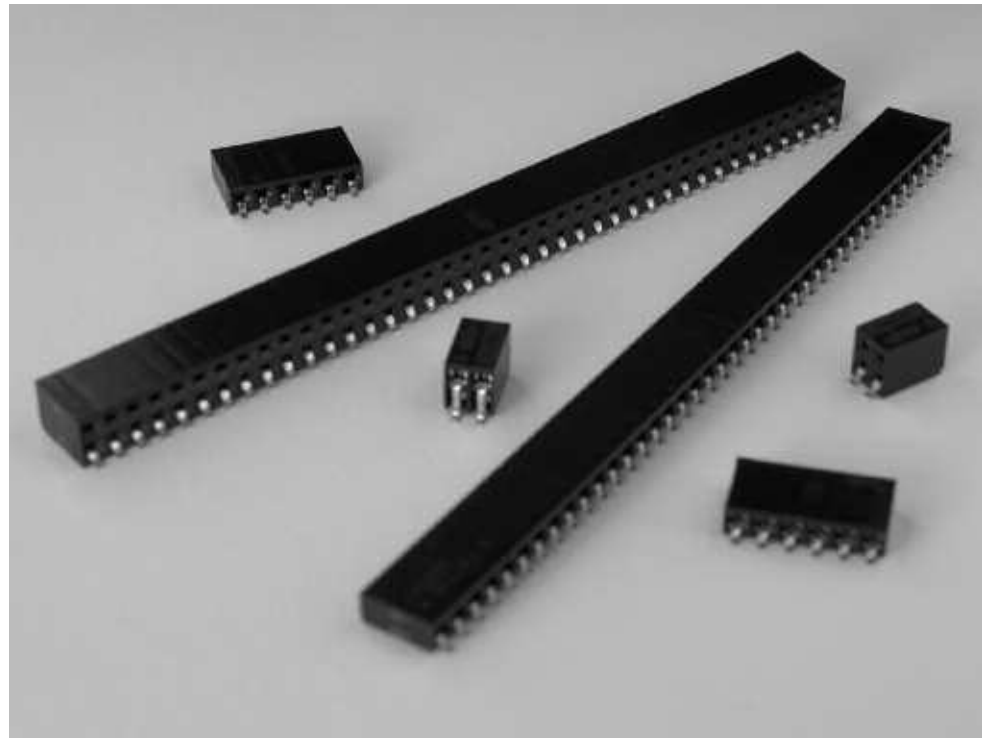

Horizontal surface mount receptacle assemblies are designed to reliably and economically meet the packaging and interconnection requirements of today's electronics industry as process technologies evolve from wave soldering to surface mount processing.

This broad product line is offered in both single and

double row configurations. The .100 [2.54] centerline assemblies are available in 2-40 (single row) positions and 4-80 (double row) positions. Housings are end stackable, which gives the advantage of added flexibility.

The housings are made of high temperature material that is 94V-0 rated. Contacts

are phosphor bronze, fully underplated with nickel to help prevent corrosion and are available in three plating options.

The receptacle contact is an established proven design, with a fully enclosed one-piece "box" to protect the contact beams with built-in anti-overstress feature.

Performance Characteristics

Mechanical Characteristics

Mating Force — 6.0 oz. [1.67N] per contact (max.)

Unmating Force — .75 oz. [0.21N] per contact (min.) during third mating cycle

Durability — 200 cycles

Environmental Characteristics

Operating Temperature — -65°C to +125°C

Electrical Characteristics

Current Rating — 3.0 amperes (max.) for single contact; 2.0 amperes (max.) per contact when connector is fully energized

Contact Resistance — 12 milliohms (max.)

Insulation Resistance — 5000 megohms (min.) between adjacent contacts

Dielectric Withstanding Voltage (at sea level) — 750 V rms

Mod II Receptacle Assemblies, Single-Row, Surface Mount .100 [2.54] Centerline

**Closed Entry, End Stackable,
Short Point-of-Contact,
with Standoffs**



Material and Finish

Housing — Glass-filled thermoplastic, black, 94V-0 rated

Contacts — Phosphor bronze, plated as follows:

Plating A — Duplex .000030 [0.00076] gold on contact area, .000150-.000300 [0.00381-0.00762] matte tin on solder area all over .000050 [0.00127] nickel

Plating B — Duplex .000010 [0.000254] gold on contact area, .000150-.000300 [0.00381-0.00762] matte tin on solder area all over .000050 [0.00127] nickel

Plating C — .000150-.000300 [0.00381-0.00762] matte tin on solder leads, all over .000050 [0.00127] nickel

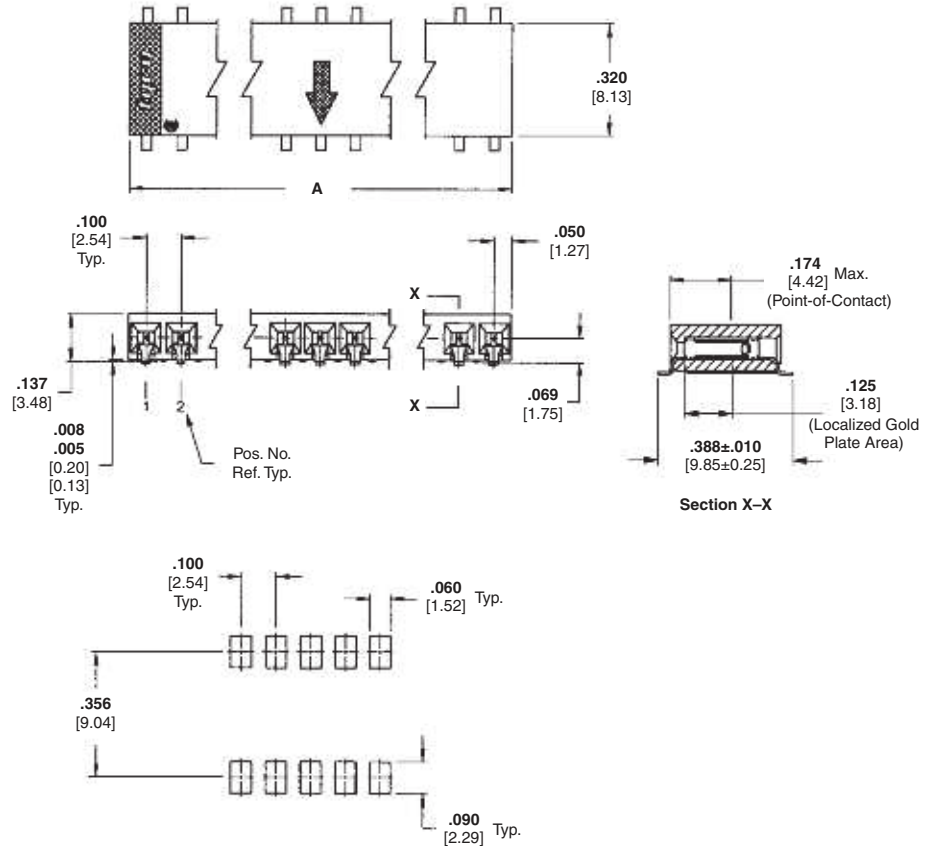

Recommended Etched Circuit Layout
(for .040 [1.02] min. thick PC Board;
.008 [0.20] thick stencil)

Related Product Data

Mateable Headers — Refer to the Mating Post Selection Guide — page 90

Performance Characteristics — page 171

Technical Documents — page 276

Product Specification
108-25026

Application Specification
114-25018

Additional receptacle assembly sizes are available; minimum order quantities may apply. Consult TE.

Keying Plug



Part No. 86286-1
(Plugs into receptacle contact)

Material — Natural color nylon

Note: All part numbers are RoHS compliant.

| No. of Pos. | Dimension A | Contact Plating/Part Nos. | | |
|-------------|----------------|---------------------------|-------------|-------------|
| | | Plating A | Plating B | Plating C |
| 2 | .200 [5.08] | 5147721-1 | 5147732-1 | 5147733-1 |
| 3 | .300 [7.62] | 5147721-2 | 5147732-2 | 5147733-2 |
| 4 | .400 [10.16] | 5147721-3 | 5147732-3 | 5147733-3 |
| 5 | .500 [12.70] | 5147721-4 | 5147732-4 | 5147733-4 |
| 6 | .600 [15.24] | 5147721-5 | 5147732-5 | 5147733-5 |
| 7 | .700 [17.78] | 5147721-6 | 5147732-6 | 5147733-6 |
| 8 | .800 [20.32] | 5147721-7 | 5147732-7 | 5147733-7 |
| 9 | .900 [22.86] | 5147721-8 | 5147732-8 | 5147733-8 |
| 10 | 1.000 [25.40] | 5147721-9 | 5147732-9 | 5147733-9 |
| 11 | 1.100 [27.94] | 1-5147721-0 | 1-5147732-0 | 1-5147733-0 |
| 12 | 1.200 [30.48] | 1-5147721-1 | 1-5147732-1 | 1-5147733-1 |
| 13 | 1.300 [33.02] | 1-5147721-2 | 1-5147732-2 | 1-5147733-2 |
| 14 | 1.400 [35.56] | 1-5147721-3 | 1-5147732-3 | 1-5147733-3 |
| 15 | 1.500 [38.10] | 1-5147721-4 | 1-5147732-4 | 1-5147733-4 |
| 16 | 1.600 [40.64] | 1-5147721-5 | 1-5147732-5 | 1-5147733-5 |
| 17 | 1.700 [43.18] | 1-5147721-6 | 1-5147732-6 | 1-5147733-6 |
| 18 | 1.800 [45.72] | 1-5147721-7 | 1-5147732-7 | 1-5147733-7 |
| 19 | 1.900 [48.26] | 1-5147721-8 | 1-5147732-8 | 1-5147733-8 |
| 20 | 2.000 [50.80] | 1-5147721-9 | 1-5147732-9 | 1-5147733-9 |
| 30 | 3.000 [76.20] | 2-5147721-9 | 2-5147732-9 | 2-5147733-9 |
| 40 | 4.000 [101.60] | 3-5147721-9 | 3-5147732-9 | 3-5147733-9 |

Mod II Receptacle Assemblies, Double-Row, Surface Mount .100 [2.54] Centerline

**Closed Entry, End Stackable,
Short Point-of-Contact,
with Standoffs**



Material and Finish

Housing — Glass-filled thermoplastic, black, 94V-0 rated

Contacts — Phosphor bronze, plated as follows:

Plating A — Duplex .000030 [0.00076] gold on contact area, .000150-.000300 [0.00381-0.00762] matte tin on solder area all over .000050 [0.00127] nickel

Plating B — Duplex .000010 [0.000254] gold on contact area, .000150-.000300 [0.00381-0.00762] matte tin on solder area all over .000050 [0.00127] nickel

Plating C — .000150-.000300 [0.00381-0.00762] matte tin on solder leads, all over .000050 [0.00127] nickel

Related Product Data

Mateable Headers — Refer to the Mating Post Selection Guide — page 90

Performance Characteristics — page 171

Technical Documents — page 276

Product Specification
108-25026

Application Specification
114-25018

Additional receptacle assembly sizes are available; minimum order quantities may apply. Consult TE.

Note: All part numbers are RoHS compliant.

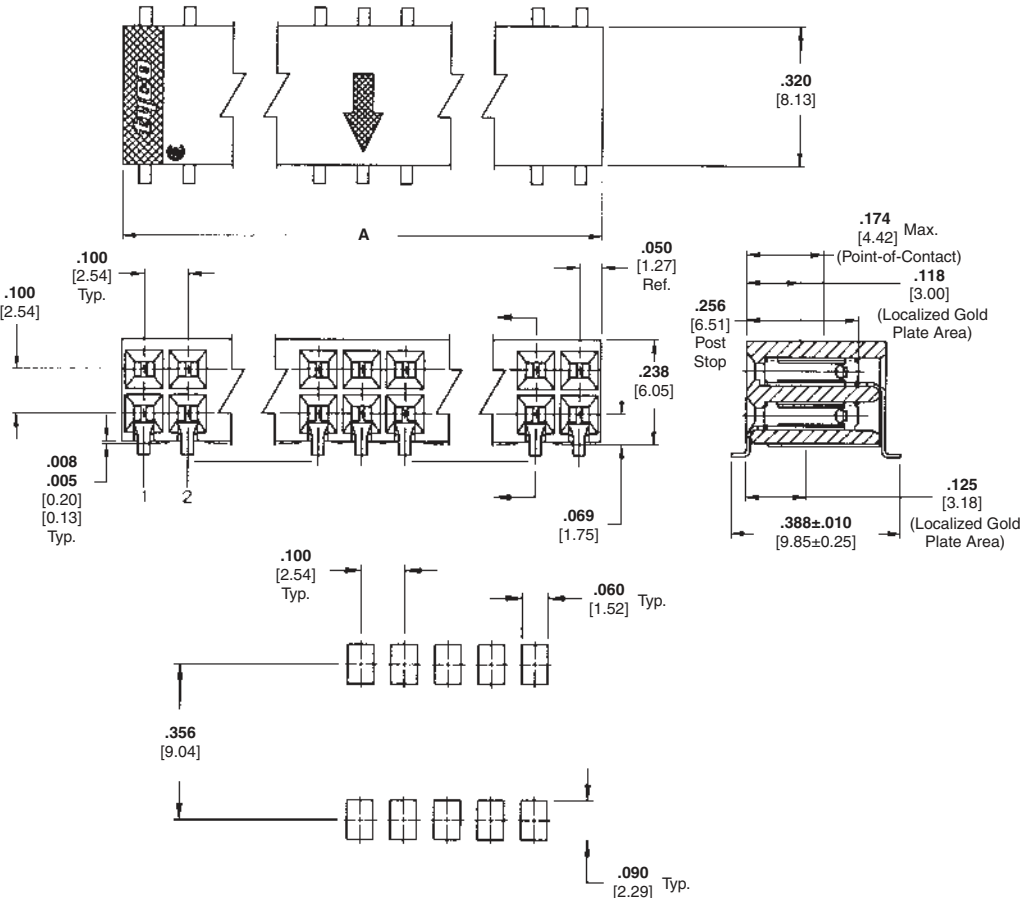



Recommended Etched Circuit Layout
(for .040 [1.02] min thick PC Board;
.008 [0.20] thick stencil)

| No. of Pos. | Dimension A | Contact Plating/Part Nos. | | |
|-------------|---------------|---------------------------|-------------|-------------|
| | | Plating A | Plating B | Plating C |
| 4 | .200 [5.08] | 5147722-1 | 5147734-1 | 5147735-1 |
| 6 | .300 [7.62] | 5147722-2 | 5147734-2 | 5147735-2 |
| 8 | .400 [10.16] | 5147722-3 | 5147734-3 | 5147735-3 |
| 10 | .500 [12.70] | 5147722-4 | 5147734-4 | 5147735-4 |
| 12 | .600 [15.24] | 5147722-5 | 5147734-5 | 5147735-5 |
| 14 | .700 [17.78] | 5147722-6 | 5147734-6 | 5147735-6 |
| 16 | .800 [20.32] | 5147722-7 | 5147734-7 | 5147735-7 |
| 18 | .900 [22.86] | 5147722-8 | 5147734-8 | 5147735-8 |
| 20 | 1.000 [25.40] | 5147722-9 | 5147734-9 | 5147735-9 |
| 22 | 1.100 [27.94] | 1-5147722-0 | 1-5147734-0 | 1-5147735-0 |
| 24 | 1.200 [30.48] | 1-5147722-1 | 1-5147734-1 | 1-5147735-1 |
| 26 | 1.300 [33.02] | 1-5147722-2 | 1-5147734-2 | 1-5147735-2 |
| 28 | 1.400 [35.56] | 1-5147722-3 | 1-5147734-3 | 1-5147735-3 |
| 30 | 1.500 [38.10] | 1-5147722-4 | 1-5147734-4 | 1-5147735-4 |
| 32 | 1.600 [40.64] | 1-5147722-5 | 1-5147734-5 | 1-5147735-5 |
| 34 | 1.700 [43.18] | 1-5147722-6 | 1-5147734-6 | 1-5147735-6 |
| 36 | 1.800 [45.72] | 1-5147722-7 | 1-5147734-7 | 1-5147735-7 |
| 38 | 1.900 [48.26] | 1-5147722-8 | 1-5147734-8 | 1-5147735-8 |
| 40 | 2.000 [50.80] | 1-5147722-9 | 1-5147734-9 | 1-5147735-9 |
| 50 | 2.500 [63.50] | 2-5147722-4 | 2-5147734-4 | 2-5147735-4 |
| 60 | 3.000 [76.20] | 2-5147722-9 | 2-5147734-9 | 2-5147735-9 |

Receptacle Assemblies, Vertical Mount

Product Facts

- Dual-cantilever beam contact with box design
- Single-row assemblies have .100 [2.54] centerline contact spacing; double-row assemblies have .100 x .100 [2.54 x 2.54] centerline contact spacing
- 3 through 40 positions in single-row assemblies; 2 through 80 positions in double-row assemblies
- Mod II Standard .340 [8.64] and Mod IV low .265 [6.73] profiles
- Mod II and Mod IV profiles available in dual entry
- Duplex gold and matte tin plated contacts have full nickel underplate
- Thermoplastic housings, 94V-0 rated
- Standoffs for easy flux cleaning
- All throughhole assemblies are end stackable
- Recognized under the Component Program of Underwriters Laboratories Inc., File No. E28476 
- Certified by Canadian Standards Association, File No. LR 7189 

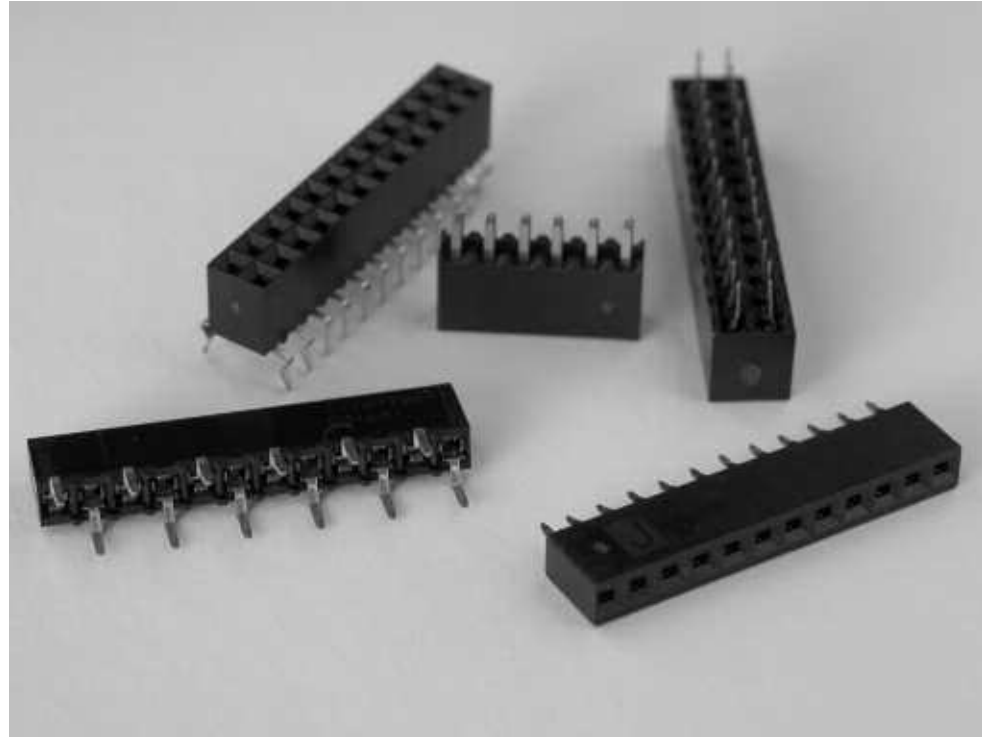

Vertical receptacle assemblies are designed to reliably and economically meet the packaging and interconnection requirements of today's electronics industry.

This broad product line offers a wide variety of assembly styles and features. They are available in dual entry style, in both single and double row configurations. The .100 [2.54] centerline assemblies are available in 3-40 (single

row) positions and 2-80 (double row) positions. Standard and low profile housings which are end stackable also enhance the product line giving the advantage of added flexibility.

The housings are made of flame retardant material that is 94 V-0 rated. Contacts are phosphor bronze, fully underplated with nickel to help prevent corrosion and are available in three plating options.

The receptacle contact is an established proven design, with a fully enclosed one-piece "box" to protect the contact beams.

These assemblies are offered in .265 [6.73] (Mod IV) and .340[8.64] (Mod II) high profiles. Standard solder tails accommodate board thickness of .062 [1.57].

Product styles include single and dual tine variations. Outrigger tine styles are also available for bottom entry parallel board stacking applications.

Performance Characteristics

Mechanical Characteristics

Mating Force — 9.0 oz. [2.5N] per contact (max.)

Unmating Force — 1.5 oz. [0.42N] per contact (min.)

Durability (Tested to) — 200 cycles

Environmental Characteristics

Operating Temperature — -65°C to +125°C

Electrical Characteristics

Current Rating — 3.0 amperes (max.) for single contact; 2.0 amperes (max.) per contact when connector is fully energized

Contact Resistance — 12 milliohms (max.)

Insulation Resistance — 5000 megohms (min.) between adjacent contacts

Dielectric Withstanding Voltage (at sea level) — 750 V rms

Mod II Receptacle Assemblies, Single-Row, .100 [2.54] Centerline

Closed Top Entry, End Stackable, with Single Tine Contacts

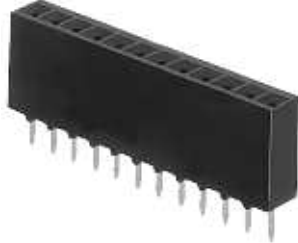

Material and Finish

Housing — Glass-filled thermoplastic, black, 94V-0 rated

Contacts — Phosphor bronze, plated as follows:

Plating A — Duplex .000030 [0.00076] gold on contact area, .000150-.000300 [0.00381-0.00762] matte tin on solder area all over .000050 [0.00127] nickel

Plating B — Duplex .000010 [0.000254] gold on contact area, .000150-.000300 [0.00381-0.00762] matte tin on solder area all over .000050 [0.00127] nickel

Plating C — .000150-.000300 [0.00381-0.00762] matte tin on solder leads, all over .000050 [0.00127] nickel

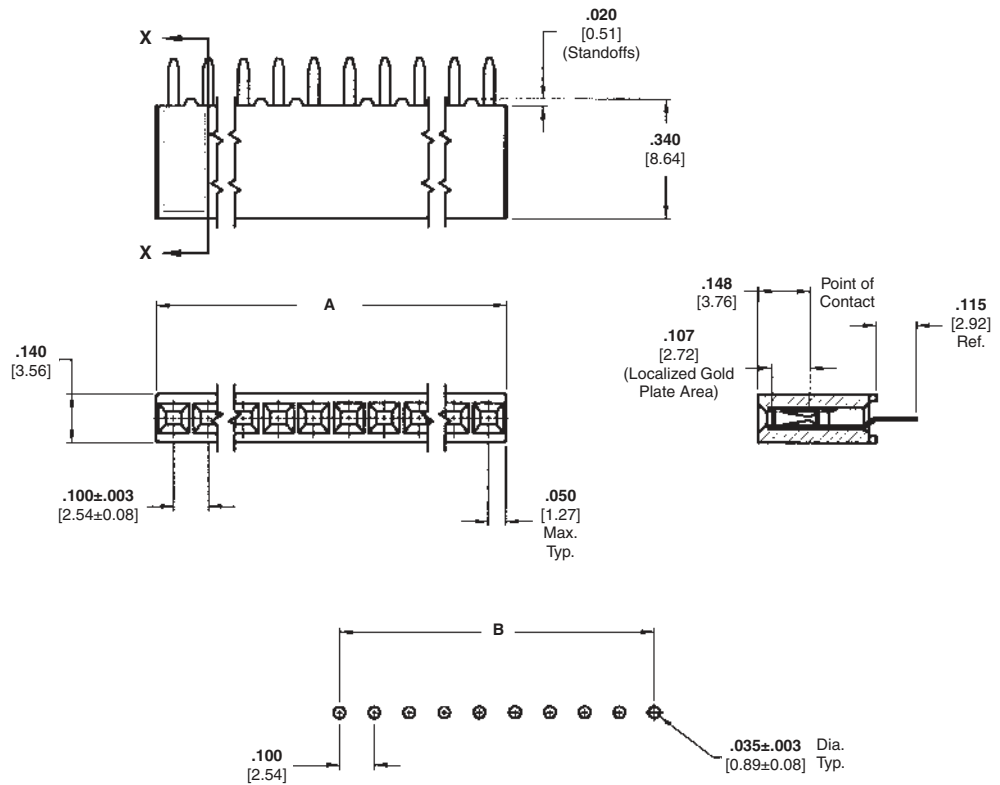

Recommended PC Board Hole Layout

Related Product Data

Mateable Headers — Refer to the Mating Post Selection Guide — page 90

Performance Characteristics — page 174

Technical Documents — page 276

Product Specification 108-25022

Application Specification 114-25018

Additional receptacle assembly sizes are available; minimum order quantities may apply. Consult TE.

Keying Plug

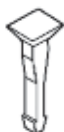

Part No. 86286-1

(Plugs into receptacle contact)

Material — Natural color nylon

| No. of Pos. | Dimensions | | Contact Plating/Part Nos. | | |
|-------------|----------------|---------------|---------------------------|------------|------------|
| | A | B | Plating A | Plating B | Plating C |
| 3 | .300 [7.62] | .200 [5.08] | 5-534237-1 | 5-146386-1 | 5-146763-5 |
| 4 | .400 [10.16] | .300 [7.62] | 5-534237-2 | 6-146386-9 | 5-146763-6 |
| 5 | .500 [12.70] | .400 [10.16] | 5-534237-3 | 5-146386-2 | 5-146763-7 |
| 6 | .600 [15.24] | .500 [12.70] | 5-534237-4 | 5-146386-3 | 5-146763-8 |
| 7 | .700 [17.78] | .600 [15.24] | 5-534237-5 | 5-146386-4 | 5-146763-1 |
| 8 | .800 [20.32] | .700 [17.78] | 5-534237-6 | 5-146386-5 | 5-146763-2 |
| 9 | .900 [22.86] | .800 [20.32] | 5-534237-7 | 5-146386-6 | 5-146763-9 |
| 10 | 1.000 [25.40] | .900 [22.86] | 5-534237-8 | 5-146386-7 | 5-146763-3 |
| 11 | 1.100 [27.94] | 1.000 [25.40] | 5-534237-9 | 5-146386-8 | 6-146763-0 |
| 12 | 1.200 [30.48] | 1.100 [27.94] | 6-534237-0 | 5-146386-9 | 6-146763-1 |
| 13 | 1.300 [33.02] | 1.200 [30.48] | 6-534237-1 | 6-146386-0 | 6-146763-2 |
| 14 | 1.400 [35.56] | 1.300 [33.02] | 6-534237-2 | 6-146386-1 | 6-146763-3 |
| 15 | 1.500 [38.10] | 1.400 [35.56] | 6-534237-3 | 7-146386-0 | 6-146763-4 |
| 16 | 1.600 [40.64] | 1.500 [38.10] | 6-534237-4 | 7-146386-1 | 6-146763-5 |
| 17 | 1.700 [43.18] | 1.600 [40.64] | 6-534237-5 | 7-146386-2 | 6-146763-6 |
| 18 | 1.800 [45.72] | 1.700 [43.18] | 6-534237-6 | 7-146386-3 | 6-146763-7 |
| 19 | 1.900 [48.26] | 1.800 [45.72] | 6-534237-7 | 7-146386-4 | 6-146763-8 |
| 20 | 2.000 [50.80] | 1.900 [48.26] | 6-534237-8 | 6-146386-2 | 6-146763-9 |
| 30 | 3.000 [76.20] | 2.900 [73.66] | 7-534237-8 | 6-146386-8 | 7-146763-8 |
| 40 | 4.000 [101.60] | 3.900 [99.06] | 8-534237-8 | 8-146386-8 | 8-146763-8 |

- Notes:** 1. TE recommends mating gold or duplex plated headers with duplex plated receptacle assemblies.
 2. To obtain the minimum mating post length, add .020 [0.51] (not including the post lead in chamfer) to the maximum point-of-contact dimension.

Note: All part numbers are RoHS compliant.

Mod II Receptacle Assemblies, Double-Row, .100 x .100 [2.54 x 2.54] Centerline

**Closed Top Entry,
Side and End Stackable
.100 x .100 [2.54 x 2.54]
Centerline, .100 [2.54]
Tine Spacing**



Material and Finish

Housing — Glass-filled thermoplastic, black, 94V-0 rated

Contacts — Phosphor bronze, plated as follows:

Plating A — Duplex .000030 [0.00076] gold on contact area, .000150-.000300 [0.00381-0.00762] matte tin on solder area all over .000050 [0.00127] nickel

Plating B — Duplex .000010 [0.000254] gold on contact area, .000150-.000300 [0.00381-0.00762] matte tin on solder area all over .000050 [0.00127] nickel

Plating C — .000150-.000300 [0.00381-0.00762] matte tin on solder leads, all over .000050 [0.00127] nickel

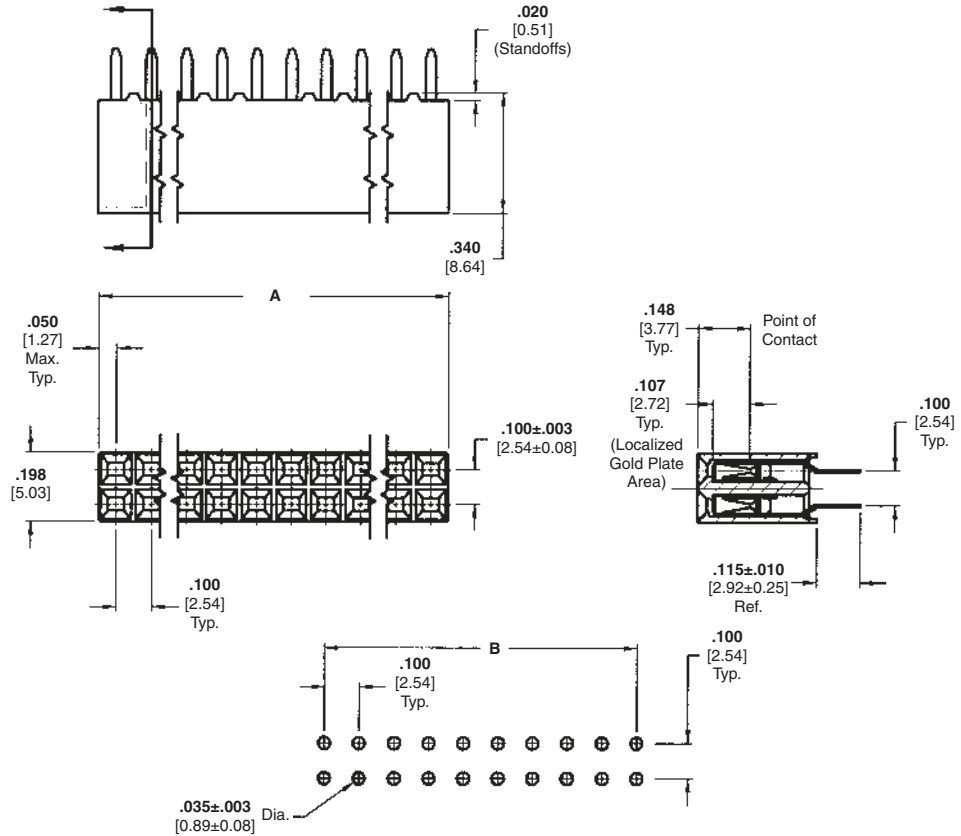

**Recommended PC Board Hole Layout
(for .062 [1.57] thick PC board)**

Related Product Data

Mateable Headers — Refer to the Mating Post Selection Guide — page 90

Performance Characteristics — page 174

Technical Documents — page 276

Product Specification
108-25022

Application Specification
114-25018

Additional receptacle assembly sizes are available; minimum order quantities may apply. Consult TE.

Keying Plug

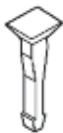

Part No. 86286-1

(Plugs into receptacle contact)

Material — Natural color nylon

| No. of Pos. | Dimensions | | Contact Plating/Part Nos. | | |
|-------------|---------------|---------------|---------------------------|------------|------------|
| | A | B | Plating A | Plating B | Plating C |
| 2 | .100 [2.54] | — | 5-534206-1 | 5-147424-1 | 5-146762-8 |
| 4 | .200 [5.08] | .100 [2.54] | 5-534206-2 | 5-147424-2 | 5-146762-9 |
| 6 | .300 [7.62] | .200 [5.08] | 5-534206-3 | 5-147424-3 | 6-146762-0 |
| 8 | .400 [10.16] | .300 [7.62] | 5-534206-4 | 5-147424-4 | 5-146762-1 |
| 10 | .500 [12.70] | .400 [10.16] | 5-534206-5 | 5-147424-5 | 5-146762-2 |
| 12 | .600 [15.24] | .500 [12.70] | 5-534206-6 | 5-147424-6 | 6-146762-1 |
| 14 | .700 [17.78] | .600 [15.24] | 5-534206-7 | 5-147424-7 | 6-146762-2 |
| 16 | .800 [20.32] | .700 [17.78] | 5-534206-8 | 5-147424-8 | 6-146762-3 |
| 18 | .900 [22.86] | .800 [20.32] | 5-534206-9 | 5-147424-9 | 5-146762-3 |
| 20 | 1.000 [25.40] | .900 [22.86] | 6-534206-0 | 6-147424-0 | 5-146762-7 |
| 22 | 1.100 [27.94] | 1.000 [25.40] | 6-534206-1 | 6-147424-1 | 6-146762-4 |
| 24 | 1.200 [30.48] | 1.100 [27.94] | 6-534206-2 | 6-147424-2 | 6-146762-5 |
| 26 | 1.300 [33.02] | 1.200 [30.48] | 6-534206-3 | 6-147424-3 | 6-146762-6 |
| 28 | 1.400 [35.56] | 1.300 [33.02] | 6-534206-4 | 6-147424-4 | 6-146762-7 |
| 30 | 1.500 [38.10] | 1.400 [35.56] | 6-534206-5 | 6-147424-5 | 5-146762-4 |
| 32 | 1.600 [40.64] | 1.500 [38.10] | 6-534206-6 | 6-147424-6 | 6-146762-8 |
| 34 | 1.700 [43.18] | 1.600 [40.64] | 6-534206-7 | 6-147424-7 | 6-146762-9 |
| 36 | 1.800 [45.72] | 1.700 [43.18] | 6-534206-8 | 6-147424-8 | 7-146762-0 |
| 38 | 1.900 [48.26] | 1.800 [45.72] | 6-534206-9 | 6-147424-9 | 7-146762-1 |
| 40 | 2.000 [50.80] | 1.900 [48.26] | 7-534206-0 | 7-147424-0 | 5-146762-5 |

Notes: 1. TE recommends mating gold or duplex plated headers with duplex plated receptacle assemblies.

2. To obtain the minimum mating post length, add .020 [0.51] (not including the post lead in chamfer) to the maximum point-of-contact dimension.

Note: All part numbers are RoHS compliant.

Mod IV Receptacle Assemblies, Single-Row, .100 [2.54] Centerline

Dual Entry, End Stackable, Low Profile with Dual Tine Contacts



Material and Finish

Housing — Glass-filled thermoplastic, black, 94V-0 rated

Contacts — Phosphor bronze, plated as follows:

Plating A — Duplex .000030 [0.00076] gold on contact area, .000150-.000300 [0.00381-0.00762] matte tin on solder area all over .000050 [0.00127] nickel

Plating B — Duplex .000010 [0.000254] gold on contact area, .000150-.000300 [0.00381-0.00762] matte tin on solder area all over .000050 [0.00127] nickel

Plating C — .000150-.000300 [0.00381-0.00762] matte tin on solder leads, all over .000050 [0.00127] nickel

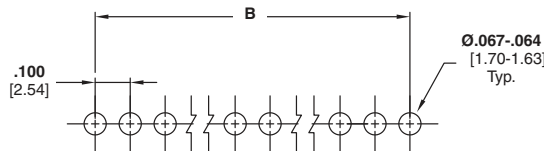
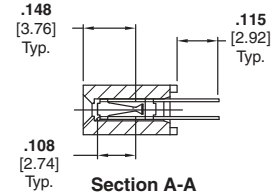
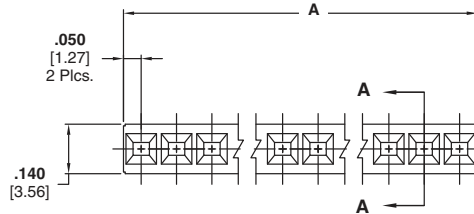
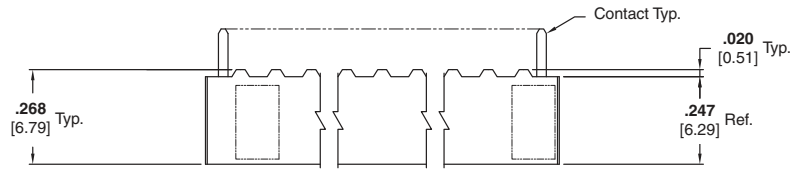

Recommended PC Board Hole Layout

Related Product Data

Mateable Headers — Refer to the Mating Post Selection Guide — page 90

Performance Characteristics — page 174

Technical Documents — page 276

Product Specification 108-25022

Application Specification 114-25018

Additional receptacle assembly sizes are available; minimum order quantities may apply. Consult TE.

Keying Plug



Part No. 86286-1
(Plugs into receptacle contact)

Material — Natural color nylon

Note: All part numbers are RoHS compliant.

| No. of Pos. | Dimensions | | Contact Plating/Part Nos. | | |
|-------------|----------------|---------------|---------------------------|------------|------------|
| | A | B | Plating A | Plating B | Plating C |
| 3 | .300 [7.62] | .200 [5.08] | 8-87879-7 | 5-147326-1 | 5-102742-4 |
| 4 | .400 [10.16] | .300 [7.62] | 8-87879-6 | 5-147326-2 | 5-102742-8 |
| 5 | .500 [12.70] | .400 [10.16] | 8-87879-8 | 5-147326-3 | 5-102742-9 |
| 6 | .600 [15.24] | .500 [12.70] | 5-87879-3 | 5-147326-4 | 6-102742-0 |
| 7 | .700 [17.78] | .600 [15.24] | 5-87879-4 | 5-147326-5 | 5-102742-7 |
| 8 | .800 [20.32] | .700 [17.78] | 5-87879-1 | 5-147326-6 | 5-102742-3 |
| 9 | .900 [22.86] | .800 [20.32] | 5-87879-5 | 5-147326-7 | 5-102742-6 |
| 10 | 1.000 [25.40] | .900 [22.86] | 5-87879-2 | 5-147326-8 | 6-102742-1 |
| 11 | 1.100 [27.94] | 1.000 [25.40] | 5-87879-6 | 5-147326-9 | 5-102742-1 |
| 12 | 1.200 [30.48] | 1.100 [27.94] | 5-87879-7 | 6-147326-0 | 5-102742-2 |
| 13 | 1.300 [33.02] | 1.200 [30.48] | 5-87879-8 | 6-147326-1 | 6-102742-2 |
| 14 | 1.400 [35.56] | 1.300 [33.02] | 5-87879-9 | 6-147326-2 | 6-102742-3 |
| 15 | 1.500 [38.10] | 1.400 [35.56] | 6-87879-0 | 6-147326-3 | 6-102742-4 |
| 16 | 1.600 [40.64] | 1.500 [38.10] | 6-87879-1 | 6-147326-4 | 5-102742-5 |
| 17 | 1.700 [43.18] | 1.600 [40.64] | 6-87879-2 | 6-147326-5 | 6-102742-5 |
| 18 | 1.800 [45.72] | 1.700 [43.18] | 6-87879-3 | 6-147326-6 | 6-102742-6 |
| 19 | 1.900 [48.26] | 1.800 [45.72] | 6-87879-4 | 6-147326-7 | 6-102742-7 |
| 20 | 2.000 [50.80] | 1.900 [48.26] | 6-87879-5 | 6-147326-8 | 6-102742-8 |
| 30 | 3.000 [76.20] | 2.900 [73.66] | 7-87879-5 | 7-147326-8 | 7-102742-8 |
| 40 | 4.000 [101.60] | 3.900 [99.06] | 8-87879-5 | 8-147326-8 | 8-102742-8 |

- Notes:** 1. TE recommends mating gold or duplex plated headers with duplex plated receptacle assemblies.
2. To obtain the minimum mating post length, add .020 [0.51] (not including the post lead in chamfer) to the maximum point-of-contact dimension and .062 for recommended board thickness.

Mod IV Receptacle Assemblies, Single-Row, .100 [2.54] Centerline

Closed Top Entry, End Stackable, Low Profile with Single Tine Contacts



Material and Finish

Housing — Glass-filled thermoplastic, black, 94V-0 rated

Contacts — Phosphor bronze, plated as follows:

Plating A — Duplex .000030 [0.00076] gold on contact area, .000150-.000300 [0.00381-0.00762] matte tin on solder area all over .000050 [0.00127] nickel

Plating B — Duplex .000010 [0.000254] gold on contact area, .000150-.000300 [0.00381-0.00762] matte tin on solder area all over .000050 [0.00127] nickel

Plating C — .000150-.000300 [0.00381-0.00762] matte tin on solder leads, all over .000050 [0.00127] nickel

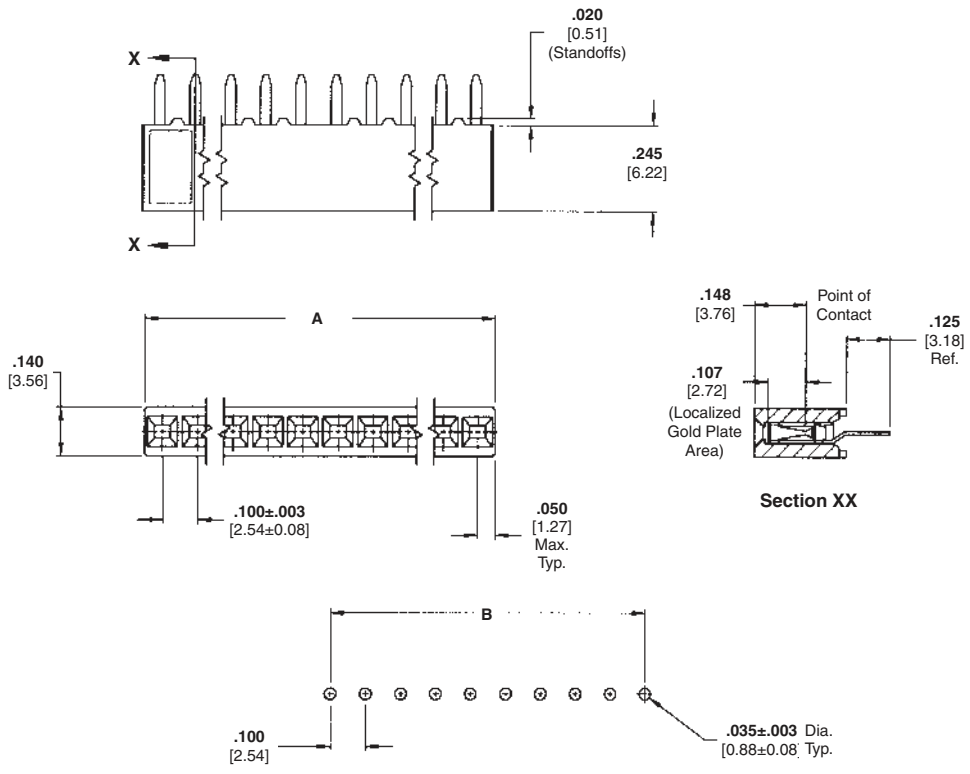

Recommended PC Board Hole Layout
(for .062 [1.57] thick PC board)

Related Product Data

Mateable Headers — Refer to the Mating Post Selection Guide — page 90

Performance Characteristics — page 174

Technical Documents — page 276

Product Specification
108-25022

Application Specification
114-25018

Additional receptacle assembly sizes are available; minimum order quantities may apply. Consult TE.

| No. of Pos. | Dimensions | | Contact Plating/Part Nos. | | |
|-------------|----------------|---------------|---------------------------|------------|------------|
| | A | B | Plating A | Plating B | Plating C |
| 3 | .300 [7.62] | .200 [5.08] | 5-535541-1 | 5-146138-1 | 5-535584-3 |
| 4 | .400 [10.16] | .300 [7.62] | 5-535541-2 | 5-146138-2 | 5-535584-4 |
| 5 | .500 [12.70] | .400 [10.16] | 5-535541-3 | 5-146138-3 | 5-535584-5 |
| 6 | .600 [15.24] | .500 [12.70] | 5-535541-4 | 5-146138-4 | 5-535584-1 |
| 7 | .700 [17.78] | .600 [15.24] | 5-535541-5 | 5-146138-5 | 5-535584-6 |
| 8 | .800 [20.32] | .700 [17.78] | 5-535541-6 | 5-146138-6 | 5-535584-7 |
| 9 | .900 [22.86] | .800 [20.32] | 5-535541-7 | 5-146138-7 | 5-535584-8 |
| 10 | 1.000 [25.40] | .900 [22.86] | 5-535541-8 | 5-146138-8 | 5-535584-9 |
| 11 | 1.100 [27.94] | 1.000 [25.40] | 5-535541-9 | 5-146138-9 | 6-535584-0 |
| 12 | 1.200 [30.48] | 1.100 [27.94] | 6-535541-0 | 6-146138-0 | 6-535584-1 |
| 13 | 1.300 [33.02] | 1.200 [30.48] | 6-535541-1 | 6-146138-1 | 6-535584-2 |
| 14 | 1.400 [35.56] | 1.300 [33.02] | 6-535541-2 | 6-146138-2 | 6-535584-3 |
| 15 | 1.500 [38.10] | 1.400 [35.56] | 6-535541-3 | 6-146138-3 | 6-535584-4 |
| 16 | 1.600 [40.64] | 1.500 [38.10] | 6-535541-4 | 6-146138-4 | 6-535584-5 |
| 17 | 1.700 [43.18] | 1.600 [40.64] | 6-535541-5 | 6-146138-5 | 6-535584-6 |
| 18 | 1.800 [45.72] | 1.700 [43.18] | 6-535541-6 | 6-146138-6 | 5-535584-2 |
| 19 | 1.900 [48.26] | 1.800 [45.72] | 6-535541-7 | 6-146138-7 | 6-535584-7 |
| 20 | 2.000 [50.80] | 1.900 [48.26] | 6-535541-8 | 6-146138-8 | 6-535584-8 |
| 30 | 3.000 [76.20] | 2.900 [73.66] | 7-535541-9 | 7-146138-9 | 6-535584-9 |
| 40 | 4.000 [101.60] | 3.900 [99.06] | 8-535541-9 | 8-146138-9 | 7-535584-0 |

Notes: 1. TE recommends mating gold or duplex plated headers with select gold plated receptacle assemblies.
2. To obtain the minimum mating post length, add .020 [0.51] (not including the post lead in chamfer) to the maximum point-of-contact dimension.

Note: All part numbers are RoHS compliant.

Mod IV Receptacle Assemblies, Double-Row, .100 x .100 [2.54 x 2.54] Centerline

Closed Top Entry, End and Side Stackable, Low Profile, .100 x .100 [2.54 x 2.54] Centerline, .100 [2.54] Tine Spacing



Material and Finish

Housing — Glass-filled thermoplastic, black, 94V-0 rated

Contacts — Phosphor bronze, plated as follows:

Plating A — Duplex .000030 [0.00076] gold on contact area, .000150-.000300 [0.00381-0.00762] matte tin on solder area all over .000050 [0.00127] nickel

Plating B — Duplex .000010 [0.000254] gold on contact area, .000150-.000300 [0.00381-0.00762] matte tin on solder area all over .000050 [0.00127] nickel

Plating C — .000150-.000300 [0.00381-0.00762] matte tin on solder leads, all over .000050 [0.00127] nickel

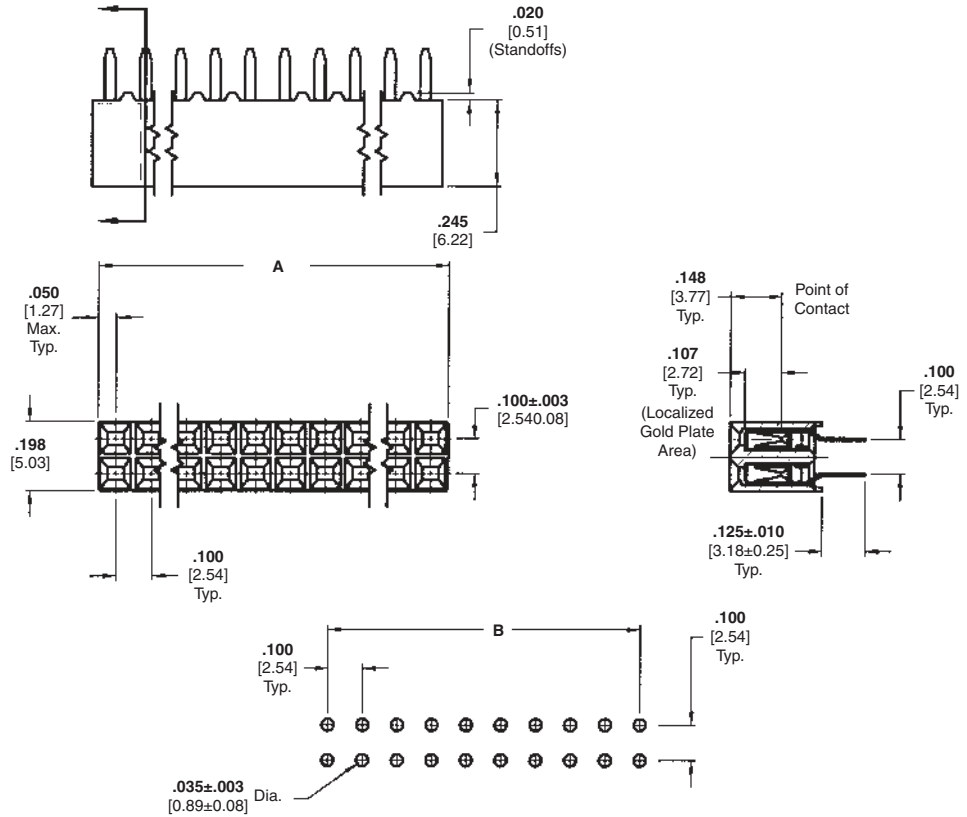

Recommended PC Board Hole Layout

Related Product Data

Mateable Headers — Refer to the Mating Post Selection Guide — page 90

Performance Characteristics — page 174

Technical Documents — page 276

Product Specification
108-25022

Application Specification
114-25018

| No. of Pos. | Dimensions | | Contact Plating/Part Nos. | | |
|-------------|---------------|---------------|---------------------------|------------|------------|
| | A | B | Plating A | Plating B | Plating C |
| 2 | .100 [2.54] | — | 5-534998-1 | 5-535598-2 | 5-535585-3 |
| 4 | .200 [5.08] | .100 [2.54] | 5-534998-2 | 5-535598-3 | 5-535585-4 |
| 6 | .300 [7.62] | .200 [5.08] | 5-534998-3 | 5-535598-4 | 5-535585-5 |
| 8 | .400 [10.16] | .300 [7.62] | 5-534998-4 | 5-535598-5 | 5-535585-6 |
| 10 | .500 [12.70] | .400 [10.16] | 5-534998-5 | 5-535598-6 | 5-535585-1 |
| 12 | .600 [15.24] | .500 [12.70] | 5-534998-6 | 5-535598-7 | 5-535585-2 |
| 14 | .700 [17.78] | .600 [15.24] | 5-534998-7 | 5-535598-1 | 5-535585-7 |
| 16 | .800 [20.32] | .700 [17.78] | 5-534998-8 | 5-535598-8 | 5-535585-8 |
| 18 | .900 [22.86] | .800 [20.32] | 5-534998-9 | 5-535598-9 | 5-535585-9 |
| 20 | 1.000 [25.40] | .900 [22.86] | 6-534998-0 | 6-535598-0 | 6-535585-0 |
| 22 | 1.100 [27.94] | 1.000 [25.40] | 6-534998-1 | 6-535598-1 | 6-535585-1 |
| 24 | 1.200 [30.48] | 1.100 [27.94] | 6-534998-2 | 6-535598-2 | 6-535585-2 |
| 26 | 1.300 [33.02] | 1.200 [30.48] | 6-534998-3 | 6-535598-3 | 6-535585-3 |
| 28 | 1.400 [35.56] | 1.300 [33.02] | 6-534998-4 | 6-535598-4 | 6-535585-4 |
| 30 | 1.500 [38.10] | 1.400 [35.56] | 6-534998-5 | 6-535598-5 | 6-535585-5 |
| 32 | 1.600 [40.64] | 1.500 [38.10] | 6-534998-6 | 6-535598-6 | 6-535585-6 |
| 34 | 1.700 [43.18] | 1.600 [40.64] | 6-534998-7 | 6-535598-7 | 6-535585-7 |
| 36 | 1.800 [45.72] | 1.700 [43.18] | 6-534998-8 | 6-535598-8 | 6-535585-8 |
| 38 | 1.900 [48.26] | 1.800 [45.72] | 6-534998-9 | 6-535598-9 | 6-535585-9 |
| 40 | 2.000 [50.80] | 1.900 [48.26] | 7-534998-0 | 7-535598-0 | 7-535585-0 |

- Notes:** 1. TE recommends mating gold or duplex plated headers with duplex plated receptacle assemblies.
2. To obtain the minimum mating post length, add .020 [0.51] (not including the post lead in chamfer) to the maximum point-of-contact dimension.

Note: All part numbers are RoHS compliant.

Mod IV Receptacle Assemblies, Double-Row, .100 x .100 [2.54 x 2.54] Centerline (Continued)

Keying Plug



Part No. 86286-1

(Plugs into receptacle contact)

Material — Natural color nylon

| No. of Pos. | Dimensions | | Contact Plating/Part Nos. | | |
|-------------|----------------|---------------|---------------------------|------------|------------|
| | A | B | Plating A | Plating B | Plating C |
| 42 | 2.100 [53.34] | 2.000 [50.80] | 7-534998-1 | 7-535598-4 | 7-535585-4 |
| 44 | 2.200 [55.88] | 2.100 [53.34] | 7-534998-2 | 7-535598-5 | 7-535585-5 |
| 46 | 2.300 [58.42] | 2.200 [55.88] | 7-534998-3 | 7-535598-6 | 7-535585-6 |
| 48 | 2.400 [60.96] | 2.300 [58.42] | 7-534998-4 | 7-535598-7 | 7-535585-7 |
| 50 | 2.500 [63.50] | 2.400 [60.96] | 7-534998-5 | 7-535598-1 | 7-535585-1 |
| 52 | 2.600 [66.04] | 2.500 [63.50] | 7-534998-6 | 7-535598-8 | 7-535585-8 |
| 54 | 2.700 [68.58] | 2.600 [66.04] | 7-534998-7 | 7-535598-9 | 7-535585-9 |
| 56 | 2.800 [71.12] | 2.700 [68.58] | 7-534998-8 | 8-535598-0 | 8-535585-0 |
| 58 | 2.900 [73.66] | 2.800 [71.12] | 7-534998-9 | 8-535598-1 | 8-535585-1 |
| 60 | 3.000 [76.20] | 2.900 [73.66] | 8-534998-0 | 7-535598-2 | 7-535585-2 |
| 62 | 3.100 [78.74] | 3.000 [76.20] | 8-534998-1 | 8-535598-2 | 8-535585-2 |
| 64 | 3.200 [81.28] | 3.100 [78.74] | 8-534998-2 | 8-535598-3 | 8-535585-3 |
| 66 | 3.300 [83.82] | 3.200 [81.28] | 8-534998-3 | 8-535598-4 | 8-535585-4 |
| 68 | 3.400 [86.36] | 3.300 [83.82] | 8-534998-4 | 8-535598-5 | 8-535585-5 |
| 70 | 3.500 [88.90] | 3.400 [86.36] | 8-534998-5 | 8-535598-6 | 8-535585-6 |
| 72 | 3.600 [91.44] | 3.500 [88.90] | 8-534998-6 | 8-535598-7 | 8-535585-7 |
| 74 | 3.700 [93.98] | 3.600 [91.44] | 8-534998-7 | 8-535598-8 | 8-535585-8 |
| 76 | 3.800 [96.52] | 3.700 [93.98] | 8-534998-8 | 8-535598-9 | 8-535585-9 |
| 78 | 3.900 [99.06] | 3.800 [96.52] | 8-534998-9 | 9-535598-0 | 9-535585-0 |
| 80 | 4.000 [101.60] | 3.900 [99.06] | 9-534998-0 | 7-535598-3 | 7-535585-3 |

Notes: 1. TE recommends mating gold or duplex plated headers with duplex plated receptacle assemblies.

2. To obtain the minimum mating post length, add .020 [0.51] (not including the post lead in chamfer) to the maximum point-of-contact dimension.

Note: All part numbers are RoHS compliant.

Mod IV Receptacle Assemblies, Single-Row, Outrigger Design .100 x .100 [2.54 x 2.54] Centerline, End To End Stackable

**Dual Entry, End Stackable,
Low Profile, .100 x .100
[2.54 x 2.54] Centerline,
.200 [5.08] Tine Spacing**



Material and Finish

Housing — Glass-filled thermoplastic, black, 94V-0 rated

Plating A — Duplex .000030 [0.00076] gold on contact area, .000150-.000300 [0.00381-0.00762] matte tin on solder area all over .000050 [0.00127] nickel

Plating B — Duplex .000010 [0.000254] gold on contact area, .000150-.000300 [0.00381-0.00762] matte tin on solder area all over .000050 [0.00127] nickel

Plating C — .000150-.000300 [0.00381-0.00762] matte tin on solder leads, all over .000050 [0.00127] nickel

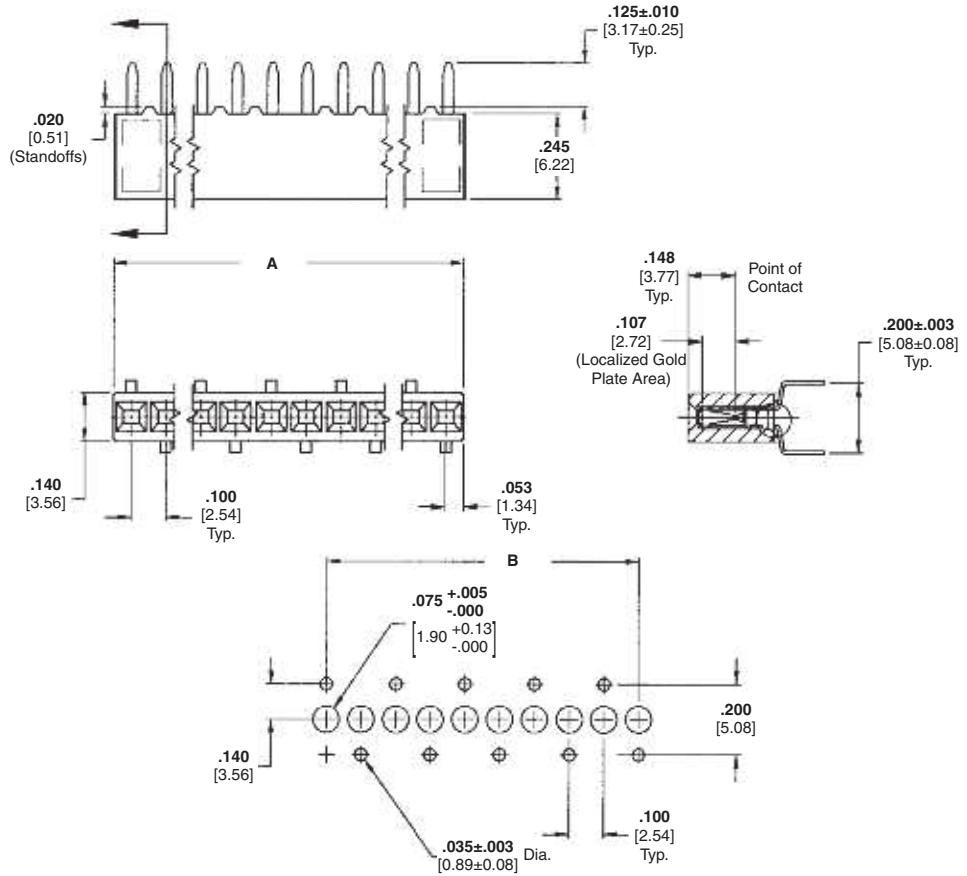

Recommended PC Board Hole Layout

| No. of Pos. | Dimensions | | Contact Plating/Part Nos. | | |
|-------------|----------------|---------------|---------------------------|------------|------------|
| | A | B | Plating A | Plating B | Plating C |
| 3 | .300 [7.62] | .200 [5.08] | 5-147720-2 | 5-147726-2 | 5-147727-2 |
| 4 | .400 [10.16] | .300 [7.62] | 5-147720-3 | 5-147726-3 | 5-147727-3 |
| 5 | .500 [12.70] | .400 [10.16] | 5-147720-4 | 5-147726-4 | 5-147727-4 |
| 6 | .600 [15.24] | .500 [12.70] | 5-147720-5 | 5-147726-5 | 5-147727-5 |
| 7 | .700 [17.78] | .600 [15.24] | 5-147720-6 | 5-147726-6 | 5-147727-6 |
| 8 | .800 [20.32] | .700 [17.78] | 5-147720-7 | 5-147726-7 | 5-147727-7 |
| 9 | .900 [22.86] | .800 [20.32] | 5-147720-8 | 5-147726-8 | 5-147727-8 |
| 10 | 1.000 [25.40] | .900 [22.86] | 5-147720-9 | 5-147726-9 | 5-147727-9 |
| 11 | 1.100 [27.94] | 1.000 [25.40] | 6-147720-0 | 6-147726-0 | 6-147727-0 |
| 12 | 1.200 [30.48] | 1.100 [27.94] | 6-147720-1 | 6-147726-1 | 6-147727-1 |
| 13 | 1.300 [33.02] | 1.200 [30.48] | 6-147720-2 | 6-147726-2 | 6-147727-2 |
| 14 | 1.400 [35.56] | 1.300 [33.02] | 6-147720-3 | 6-147726-3 | 6-147727-3 |
| 15 | 1.500 [38.10] | 1.400 [35.56] | 6-147720-4 | 6-147726-4 | 6-147727-4 |
| 16 | 1.600 [40.64] | 1.500 [38.10] | 6-147720-5 | 6-147726-5 | 6-147727-5 |
| 17 | 1.700 [43.18] | 1.600 [40.64] | 6-147720-6 | 6-147726-6 | 6-147727-6 |
| 18 | 1.800 [45.72] | 1.700 [43.18] | 6-147720-7 | 6-147726-7 | 6-147727-7 |
| 19 | 1.900 [48.26] | 1.800 [45.72] | 6-147720-8 | 6-147726-8 | 6-147727-8 |
| 20 | 2.000 [50.80] | 1.900 [48.26] | 7-147720-8 | 7-147726-8 | 7-147727-8 |
| 30 | 3.000 [76.20] | 2.900 [73.66] | 8-147720-8 | 8-147726-8 | 8-147727-8 |
| 40 | 4.000 [101.60] | 3.900 [99.06] | 8-147720-9 | 8-147726-9 | 8-147727-9 |

Notes: 1. TE recommends mating gold or duplex plated headers with duplex plated receptacle assemblies.

2. To obtain the minimum mating post length, add .020 [0.51] (not including the post lead in chamfer) to the maximum point-of-contact dimension and add .062 [1.57] for recommended board thickness if used in bottom entry application.

Note: All part numbers are RoHS compliant.

Mod IV Receptacle Assemblies, Double-Row, Outtrigger Design, .100 x .100 [2.54 x 2.54] Centerline, End to End Stackable

Dual Entry, End Stackable, Low Profile, .100 x .100 [2.54 x 2.54] Centerline, .300 [7.62] Tine Spacing

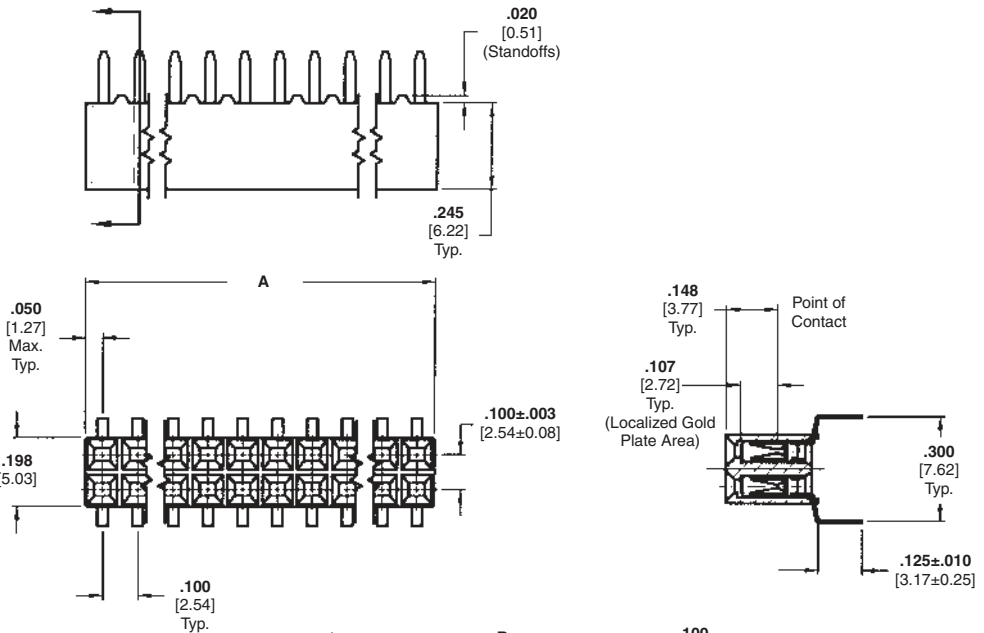
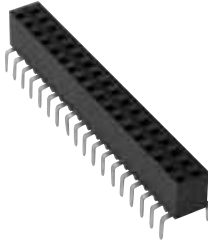

Material and Finish

Housing — Glass-filled thermoplastic, black, 94V-0 rated

Contacts — Phosphor bronze, plated as follows:

Plating A — Duplex .000030 [0.00076] gold on contact area, .000150-.000300 [0.00381-0.00762] matte tin on solder area all over .000050 [0.00127] nickel

Plating B — Duplex .000010 [0.000254] gold on contact area, .000150-.000300 [0.00381-0.00762] matte tin on solder area all over .000050 [0.00127] nickel

Plating C — .000150-.000300 [0.00381-0.00762] matte tin on solder leads, all over .000050 [0.00127] nickel

Related Product Data

Mateable Headers — Refer to the Mating Post Selection Guide — page 90

Performance Characteristics — page 174

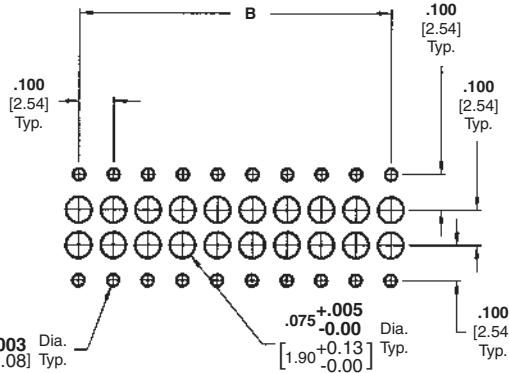

Recommended PC Board Hole Layout

Technical Documents — page 276

Product Specification 108-25022

Application Specification 114-25018

Additional receptacle assembly sizes are available; minimum order quantities may apply. Consult TE.



Part No. 86286-1
(Plugs into receptacle contact)

Material — Natural color nylon

| No. of Pos. | Dimensions | | Contact Plating/Part Nos. | | |
|-------------|----------------|---------------|---------------------------|------------|------------|
| | A | B | Plating A | Plating B | Plating C |
| 2 | .100 [2.54] | — | 6-534267-3 | 5-147099-1 | 8-147100-9 |
| 4 | .200 [5.08] | .100 [2.54] | 6-534267-7 | 5-147099-2 | 9-147100-0 |
| 6 | .300 [7.62] | .200 [5.08] | 6-534267-4 | 5-147099-3 | 5-147100-1 |
| 8 | .400 [10.16] | .300 [7.62] | 5-534267-5 | 5-147099-4 | 5-147100-2 |
| 14 | .700 [17.78] | .600 [15.24] | 5-534267-1 | 5-147099-7 | 5-147100-5 |
| 18 | .900 [22.86] | .800 [20.32] | 6-534267-0 | 5-147099-9 | 5-147100-7 |
| 20 | 1.000 [25.40] | .900 [22.86] | 5-534267-2 | 6-147099-0 | 5-147100-8 |
| 24 | 1.200 [30.48] | 1.100 [27.94] | 5-534267-9 | 6-147099-2 | 6-147100-0 |
| 30 | 1.500 [38.10] | 1.400 [35.56] | 6-534267-2 | 6-147099-5 | 6-147100-3 |
| 36 | 1.800 [45.72] | 1.700 [43.18] | 6-534267-5 | 6-147099-8 | 6-147100-6 |
| 40 | 2.000 [50.80] | 1.900 [48.26] | 5-534267-7 | 7-147099-0 | 6-147100-8 |
| 48 | 2.400 [60.96] | 2.300 [58.42] | 6-534267-1 | 7-147099-4 | 7-147100-2 |
| 50 | 2.500 [63.50] | 2.400 [60.96] | 6-534267-8 | 7-147099-5 | 7-147100-3 |
| 60 | 3.000 [76.20] | 2.900 [73.66] | 5-534267-8 | 8-147099-0 | 7-147100-8 |
| 76 | 3.800 [96.52] | 3.700 [93.98] | 6-534267-6 | 8-147099-8 | 8-147100-6 |
| 80 | 4.000 [101.60] | 3.900 [99.06] | 5-534267-4 | 9-147099-0 | 8-147100-8 |

- Notes:** 1. TE recommends mating gold or duplex plated headers with duplex plated receptacle assemblies.
2. To obtain the minimum mating post length, add .020 [0.51] (not including the post lead in chamfer) to the maximum point-of-contact dimension and .062 for recommended board thickness if used in bottom entry application.

Note: All part numbers are RoHS compliant.

Mod. IV Receptacle Assemblies, Double-Row, .100 x .100 [2.54 x 2.54] Centerline

Closed Dual Entry, Side and End Stackable Low Profile, .100 x .100 [2.54 x 2.54] Centerline, .150 [3.81] Tine Spacing

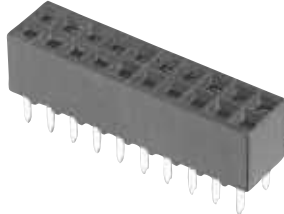

Material and Finish

Housing — Glass-filled thermoplastic, black, 94V-0 rated

Contacts — Phosphor bronze, plated as follows:

Plating A — Duplex .000030 [0.00076] gold on contact area, .000150-.000300 [0.00381-0.00762] matte tin on solder area all over .000050 [0.00127] nickel

Plating B — Duplex .000010 [0.000254] gold on contact area, .000150-.000300 [0.00381-0.00762] matte tin on solder area all over .000050 [0.00127] nickel

Plating C — .000150-.000300 [0.00381-0.00762] matte tin on solder leads, all over .000050 [0.00127] nickel

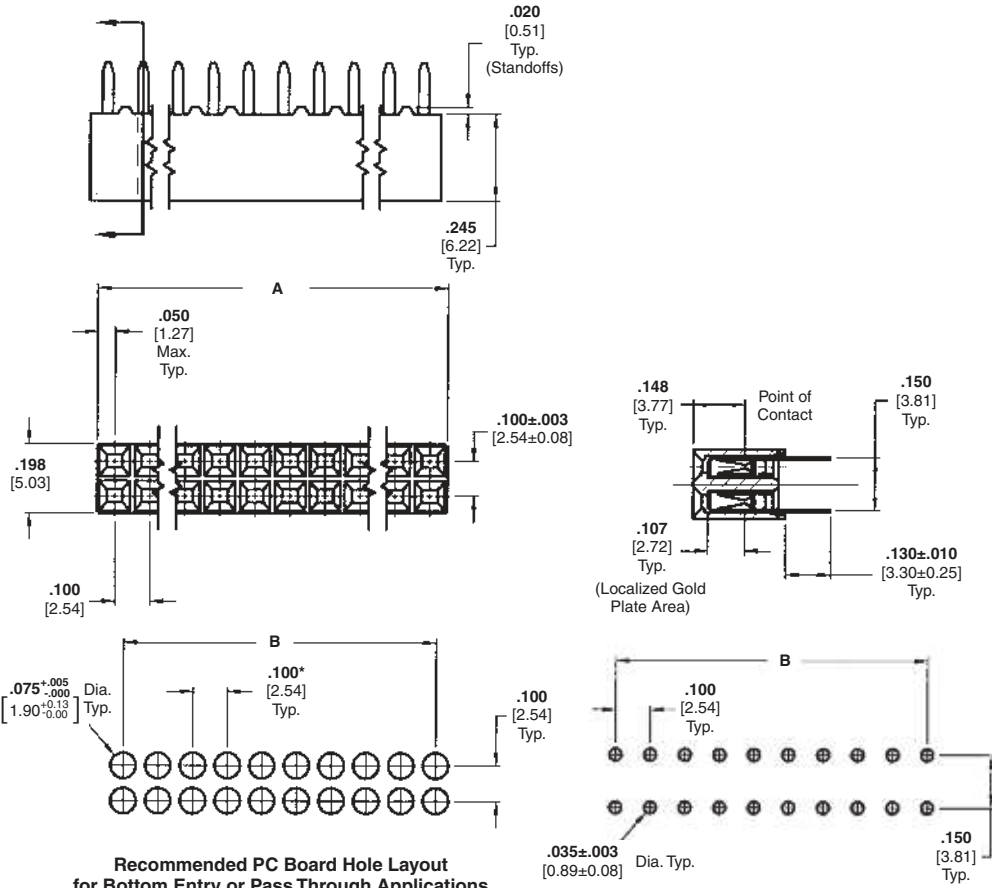

Recommended PC Board Hole Layout for Bottom Entry or Pass Through Applications

*±.003 [±0.08] tolerances not to accumulate within one connector pattern.

Recommended PC Board Hole Layout for Top Entry

Related Product Data

Mateable Headers — Refer to the Mating Post Selection Guide — page 90

Performance Characteristics — page 174

Technical Documents — page 276

Product Specification
108-25022

Application Specification
114-25018

| No. of Pos. | Dimensions | | Contact Plating/Part Nos. | | |
|-------------|---------------|---------------|---------------------------|------------|------------|
| | A | B | Plating A | Plating B | Plating C |
| 2 | .100 [2.54] | — | 5-535542-1 | 5-147095-1 | 5-147096-1 |
| 4 | .200 [5.08] | .100 [2.54] | 5-535542-2 | 5-147095-2 | 5-147096-2 |
| 6 | .300 [7.62] | .200 [5.08] | 5-535542-3 | 5-147095-3 | 5-147096-3 |
| 8 | .400 [10.16] | .300 [7.62] | 5-535542-4 | 5-147095-4 | 5-147096-4 |
| 10 | .500 [12.70] | .400 [10.16] | 5-535542-5 | 5-147095-5 | 5-147096-5 |
| 12 | .600 [15.24] | .500 [12.70] | 5-535542-6 | 5-147095-6 | 5-147096-6 |
| 14 | .700 [17.78] | .600 [15.24] | 5-535542-7 | 5-147095-7 | 5-147096-7 |
| 16 | .800 [20.32] | .700 [17.78] | 5-535542-8 | 5-147095-8 | 5-147096-8 |
| 18 | .900 [22.86] | .800 [20.32] | 5-535542-9 | 5-147095-9 | 5-147096-9 |
| 20 | 1.000 [25.40] | .900 [22.86] | 6-535542-0 | 6-147095-0 | 6-147096-0 |
| 22 | 1.100 [27.94] | 1.000 [25.40] | 6-535542-1 | 6-147095-1 | 6-147096-1 |
| 24 | 1.200 [30.48] | 1.100 [27.94] | 6-535542-2 | 6-147095-2 | 6-147096-2 |
| 26 | 1.300 [33.02] | 1.200 [30.48] | 6-535542-3 | 6-147095-3 | 6-147096-3 |
| 28 | 1.400 [35.56] | 1.300 [33.02] | 6-535542-4 | 6-147095-4 | 6-147096-4 |
| 30 | 1.500 [38.10] | 1.400 [35.56] | 6-535542-5 | 6-147095-5 | 6-147096-5 |
| 32 | 1.600 [40.64] | 1.500 [38.10] | 6-535542-6 | 6-147095-6 | 6-147096-6 |
| 34 | 1.700 [43.18] | 1.600 [40.64] | 6-535542-7 | 6-147095-7 | 6-147096-7 |
| 36 | 1.800 [45.72] | 1.700 [43.18] | 6-535542-8 | 6-147095-8 | 6-147096-8 |
| 38 | 1.900 [48.26] | 1.800 [45.72] | 6-535542-9 | 6-147095-9 | 6-147096-9 |
| 40 | 2.000 [50.80] | 1.900 [48.26] | 7-535542-0 | 7-147095-0 | 7-147096-0 |

Notes: 1. TE recommends mating gold or duplex plated headers with duplex plated receptacle assemblies.
2. To obtain the minimum mating post length, add .020 [0.51] (not including the post lead in chamfer) to the maximum point-of-contact dimension, and .062 [1.57] for recommended board thickness if used in bottom entry application.

Note: All part numbers are RoHS compliant.

**Mod. IV Receptacle Assemblies, Double-Row,
.100 x .100 [2.54 x 2.54] Centerline** (Continued)

| No. of Pos. | Dimensions | | Contact Plating/Part Nos. | | |
|-------------|----------------|---------------|---------------------------|------------|------------|
| | A | B | Plating A | Plating B | Plating C |
| 42 | 2.100 [53.34] | 2.000 [50.80] | 7-535542-1 | 7-147095-1 | 7-147096-1 |
| 44 | 2.200 [55.88] | 2.100 [53.34] | 7-535542-2 | 7-147095-2 | 7-147096-2 |
| 46 | 2.300 [58.42] | 2.200 [55.88] | 7-535542-3 | 7-147095-3 | 7-147096-3 |
| 48 | 2.400 [60.96] | 2.300 [58.42] | 7-535542-4 | 7-147095-4 | 7-147096-4 |
| 50 | 2.500 [63.50] | 2.400 [60.96] | 7-535542-5 | 7-147095-5 | 7-147096-5 |
| 52 | 2.600 [66.04] | 2.500 [63.50] | 7-535542-6 | 7-147095-6 | 7-147096-6 |
| 54 | 2.700 [68.58] | 2.600 [66.04] | 7-535542-7 | 7-147095-7 | 7-147096-7 |
| 56 | 2.800 [71.12] | 2.700 [68.58] | 7-535542-8 | 7-147095-8 | 7-147096-8 |
| 58 | 2.900 [73.66] | 2.800 [71.12] | 7-535542-9 | 7-147095-9 | 7-147096-9 |
| 60 | 3.000 [76.20] | 2.900 [73.66] | 8-535542-0 | 8-147095-0 | 8-147096-0 |
| 62 | 3.100 [78.74] | 3.000 [76.20] | 8-535542-1 | 8-147095-1 | 8-147096-1 |
| 64 | 3.200 [81.28] | 3.100 [78.74] | 8-535542-2 | 8-147095-2 | 8-147096-2 |
| 66 | 3.300 [83.82] | 3.200 [81.28] | 8-535542-3 | 8-147095-3 | 8-147096-3 |
| 68 | 3.400 [86.36] | 3.300 [83.82] | 8-535542-4 | 8-147095-4 | 8-147096-4 |
| 70 | 3.500 [88.90] | 3.400 [86.36] | 8-535542-5 | 8-147095-5 | 8-147096-5 |
| 72 | 3.600 [91.44] | 3.500 [88.90] | 8-535542-6 | 8-147095-6 | 8-147096-6 |
| 74 | 3.700 [93.98] | 3.600 [91.44] | 8-535542-7 | 8-147095-7 | 8-147096-7 |
| 76 | 3.800 [96.52] | 3.700 [93.98] | 8-535542-8 | 8-147095-8 | 8-147096-8 |
| 78 | 3.900 [99.06] | 3.800 [96.52] | 8-535542-9 | 8-147095-9 | 8-147096-9 |
| 80 | 4.000 [101.60] | 3.900 [99.06] | 9-535542-0 | 9-147095-0 | 9-147096-0 |



Vertical Mount
Receptacle Assemblies

5

Note: All part numbers are RoHS compliant.

Mod IV Surface Mount Vertical Receptacle Assemblies, .100 x .100 [2.54 x 2.54] Centerline

Product Facts

- Surface Mount Leads
- Contact Material: phosphor bronze
- High temperature, black thermoplastic housings, 94V-0 rated, capable of withstanding IR or vapor-phase reflow
- Gold/tin duplex plating for reliable mating interconnection and solder interface
- Metallic hold downs provide retention in the PC board prior to and during the reflow process ... and strain relief after soldering
- Hold downs provide for proper lead-to-pad registration
- Closed-entry receptacle housings provide lead-in ramp for positive mating
- Receptacle contacts employ dual cantilever beams for reliable connections
- Recognized under the Component Program of Underwriters Laboratories Inc.  File No. E28476
- Certified by Canadian Standards Association,  File No. LR 7189

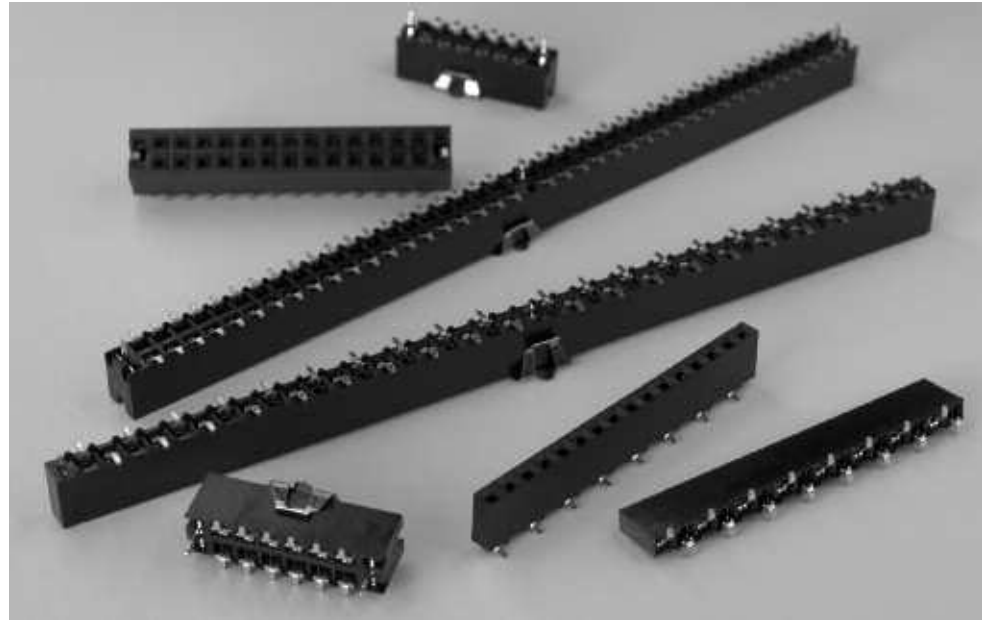

The AMPMODU 0.025 [0.64] square interconnection system is an industry standard that has provided level III and IV thru-hole interconnections to almost every industry and marketplace for years. As technology advances, so has the AMPMODU product line.

Surface mount vertical receptacle assemblies are available to meet your level II packaging needs as process technologies evolve from wave soldering to surface mount reflow (infrared and vapor-phase) processes. AMPMODU surface mount receptacle assemblies are offered in vertical dual entry configurations. These receptacles are available in single-row and double-row configurations with a contact centerline spacing of .100 x .100 [2.54 x 2.54].

AMPMODU surface mount vertical receptacle assemblies continue to provide the proven features and benefits of their thru-hole counterparts in the AMPMODU product family. Closed-entry style housing design provides a lead-in ramp for positive mating of contacts, virtually eliminating the possibility of stubbing. The dual-beam receptacle contact design, coupled with gold plating in the contact area, provides a reliable interface. Tin plating on the solder tails also enhances solderability.

The incorporation of compliant metallic hold downs on receptacle assemblies offers multiple benefits. The hold downs provide for proper lead-to-pad registration and provide retention to the PC board prior to and during processing. Used with a plated thru-hole, the hold

downs are soldered during the reflow process and serve as a strain relief for the solder joints during mating/unmating.

The design of the hold downs results in an excellent ratio of insertion/extraction forces (into the PC board); 20 lb. [89 N] maximum insertion force per pair and 10 lb. [44.5 N] minimum extraction force per pair (unsoldered). No tools are required for insertion.

**Mod IV Surface Mount Vertical Receptacle Assemblies,
.100 x .100 [2.54 x 2.54] Centerline** (Continued)

Performance Specifications**Voltage Rating:** 250 VAC**Current Rating:** 3.0 amperes (max.) for single contact;
2.0 amperes (max.) per contact when connector is fully energized**Operating Temperature Range (Receptacle Assemblies):** -65°C to +125°C**Operating Temperature Range (Headers):** -65°C to +105°C**Dielectric Withstanding Voltage:** 750 VAC**Termination Resistance:** 12 milliohms (max.)**Insulation Resistance:** 5000 megohms (min.)**Mating Force (Receptacle Assemblies):** 9.0 oz. [2.50N] (max.) per contact**Unmating Force (Receptacle Assemblies):** 1.5 oz. [0.42N] (min.) per contact**Durability:** Tested to 200 cycles (min.) for .000030 [0.00076] gold plated contacts

Mod IV Receptacle Assemblies, Single-Row, Surface Mount, .100 [2.54] Centerline with Compliant Pin Hold Downs

Surface Mount, Single-Row, Dual Entry with Compliant Pin Holddowns

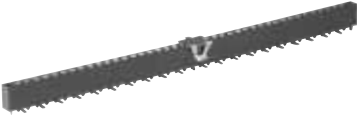

Material and Finish

Housing — Glass-filled thermoplastic, black, 94V-0 rated

Contacts — Phosphor bronze, plated as follows:

Plating A — Duplex .000030 [0.00076] gold on contact area, .000150-.000300 [0.00381-0.00762] matte tin on solder area all over .000050 [0.00127] nickel

Plating B — Duplex .000010 [0.000254] gold on contact area, .000150-.000300 [0.00381-0.00762] matte tin on solder area all over .000050 [0.00127] nickel

Plating C — .000150-.000300 [0.00381-0.00762] matte tin on solder leads, all over .000050 [0.00127] nickel

Related Product Data

Mateable Headers — Refer to Mating Post Selection Guide — page 90

Performance Specifications — page 186

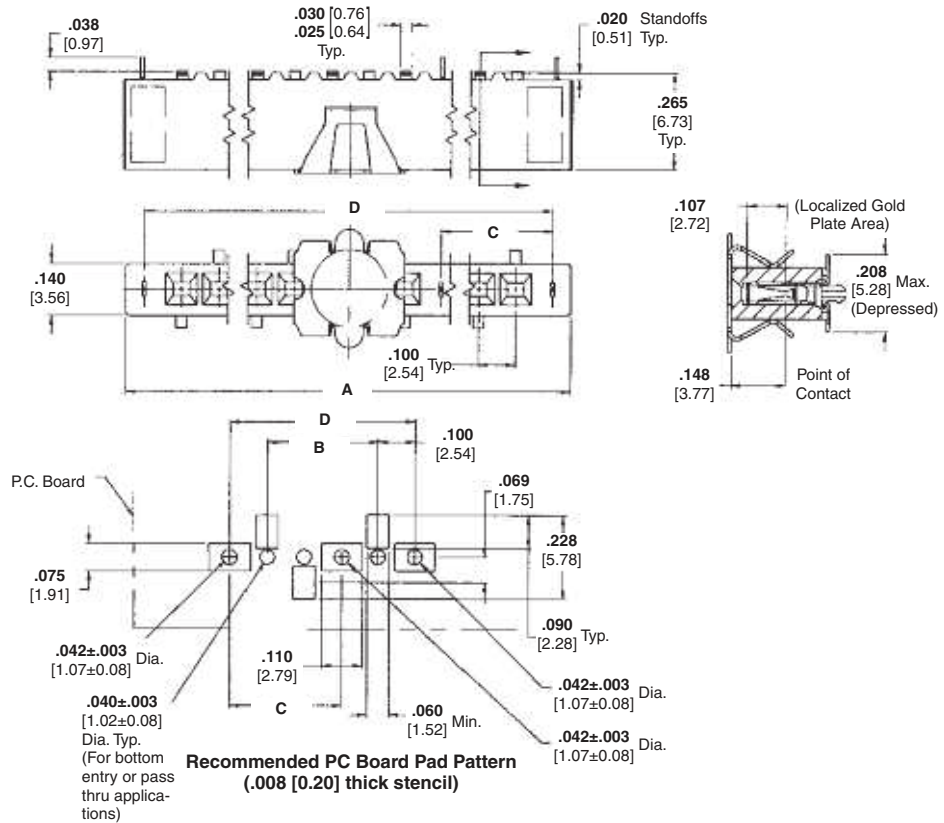

| No. of Pos. | Dimensions | | | | Packaged in Tubes | | | Packaged in Tape & Reel | | |
|-------------|----------------|----------------|---------------|----------------|----------------------------|------------|------------|----------------------------|------------|------------|
| | A | B | C | D | Contact Plating/ Part Nos. | | | Contact Plating/ Part Nos. | | |
| | | | | | Plating A | Plating B | Plating C | Plating A | Plating B | Plating C |
| 3 | .500 [12.70] | .200 [5.08] | See note 3 | .400 [10.16] | 5-147744-1 | 5-147743-1 | 5-147742-1 | 5-147724-1 | 5-147730-1 | 5-147731-1 |
| 4 | .600 [15.24] | .300 [7.62] | See note 3 | .500 [12.70] | 5-147744-2 | 5-147743-2 | 5-147742-2 | 5-147724-2 | 5-147730-2 | 5-147731-2 |
| 5 | .700 [17.78] | .400 [10.16] | See note 3 | .600 [15.24] | 5-147744-3 | 5-147743-3 | 5-147742-3 | 5-147724-3 | 5-147730-3 | 5-147731-3 |
| 6 | .800 [20.32] | .500 [12.70] | See note 3 | .700 [17.78] | 5-147744-4 | 5-147743-4 | 5-147742-4 | 5-147724-4 | 5-147730-4 | 5-147731-4 |
| 7 | .900 [22.86] | .600 [15.24] | See note 3 | .800 [20.32] | 5-147744-5 | 5-147743-5 | 5-147742-5 | 5-147724-5 | 5-147730-5 | 5-147731-5 |
| 8 | 1.000 [25.40] | .700 [17.78] | See note 3 | .900 [22.86] | 5-147744-6 | 5-147743-6 | 5-147742-6 | 5-147724-6 | 5-147730-6 | 5-147731-6 |
| 9 | 1.100 [27.94] | .800 [20.32] | See note 3 | 1.000 [25.40] | 5-147744-7 | 5-147743-7 | 5-147742-7 | 5-147724-7 | 5-147730-7 | 5-147731-7 |
| 10 | 1.200 [30.48] | .900 [22.86] | See note 3 | 1.100 [27.94] | 5-147744-8 | 5-147743-8 | 5-147742-8 | 5-147724-8 | 5-147730-8 | 5-147731-8 |
| 11 | 1.300 [33.02] | 1.000 [25.40] | See note 3 | 1.200 [30.48] | 5-147744-9 | 5-147743-9 | 5-147742-9 | 5-147724-9 | 5-147730-9 | 5-147731-9 |
| 12 | 1.400 [35.56] | 1.100 [27.94] | See note 3 | 1.300 [33.02] | 6-147744-0 | 6-147743-0 | 6-147742-0 | 6-147724-0 | 6-147730-0 | 6-147731-0 |
| 13 | 1.500 [38.10] | 1.200 [30.48] | See note 3 | 1.400 [35.56] | 6-147744-1 | 6-147743-1 | 6-147742-1 | 6-147724-1 | 6-147730-1 | 6-147731-1 |
| 14 | 1.600 [40.64] | 1.300 [33.02] | See note 3 | 1.500 [38.10] | 6-147744-2 | 6-147743-2 | 6-147742-2 | 6-147724-2 | 6-147730-2 | 6-147731-2 |
| 15 | 1.700 [43.18] | 1.400 [35.56] | See note 3 | 1.600 [40.64] | 6-147744-3 | 6-147743-3 | 6-147742-3 | 6-147724-3 | 6-147730-3 | 6-147731-3 |
| 16 | 1.800 [45.72] | 1.500 [38.10] | See note 3 | 1.700 [43.18] | 6-147744-4 | 6-147743-4 | 6-147742-4 | 6-147724-4 | 6-147730-4 | 6-147731-4 |
| 17 | 1.900 [48.26] | 1.600 [40.64] | See note 3 | 1.800 [45.72] | 6-147744-5 | 6-147743-5 | 6-147742-5 | 6-147724-5 | 6-147730-5 | 6-147731-5 |
| 18 | 2.000 [50.80] | 1.700 [43.18] | See note 3 | 1.900 [48.26] | 6-147744-6 | 6-147743-6 | 6-147742-6 | 6-147724-6 | 6-147730-6 | 6-147731-6 |
| 19 | 2.100 [53.34] | 1.800 [45.72] | See note 3 | 2.000 [50.80] | 6-147744-7 | 6-147743-7 | 6-147742-7 | 6-147724-7 | 6-147730-7 | 6-147731-7 |
| 20 | 2.200 [55.88] | 1.900 [48.26] | See note 3 | 2.100 [53.34] | 6-147744-8 | 6-147743-8 | 6-147742-8 | 6-147724-8 | 6-147730-8 | 6-147731-8 |
| 30 | 3.200 [81.28] | 2.900 [73.66] | See note 3 | 3.100 [78.74] | 7-147744-8 | 7-147743-8 | 7-147742-8 | 7-147724-8 | 7-147730-8 | 7-147731-8 |
| 40 | 4.300 [109.22] | 4.100 [104.14] | 2.100 [53.34] | 4.200 [106.68] | 8-147744-8 | 8-147743-8 | 8-147742-8 | 8-147724-8 | 8-147730-8 | 8-147731-8 |

- Notes:**
1. TE recommends mating gold or duplex plated headers with duplex plated receptacle assemblies.
 2. To obtain the minimum mating post length, add .020 [0.51] (not including the post lead in chamfer) to the maximum point-of-contact dimension, and .062 [1.57] for recommended board thickness if used in bottom entry application
 3. No center hold down.

Note: All part numbers are RoHS compliant.

Mod IV Receptacle Assemblies, Single-Row, Surface Mount, .100 [2.54] x .100 [2.54] Centerline End To End Stackable without Compliant Pin Holdowns

Surface Mount, Single-Row, Dual Entry, End to End Stackable

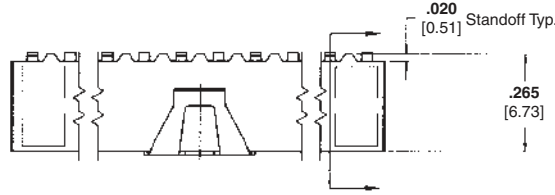

Material and Finish

Housing — Glass-filled thermoplastic, black, 94V-0 rated

Contacts — Phosphor bronze, plated as follows:

Plating A — Duplex .000030 [0.00076] gold on contact area, .000150-.000300 [0.00381-0.00762] matte tin on solder area all over .000050 [0.00127] nickel

Plating B — Duplex .000010 [0.000254] gold on contact area, .000150-.000300 [0.00381-0.00762] matte tin on solder area all over .000050 [0.00127] nickel

Plating C — .000150-.000300 [0.00381-0.00762] matte tin on solder leads, all over .000050 [0.00127] nickel

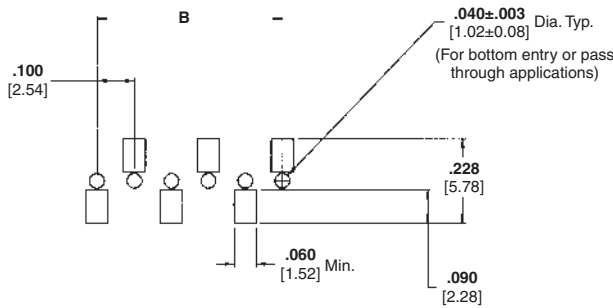
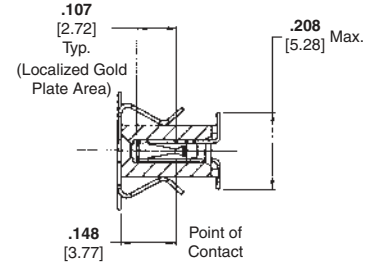
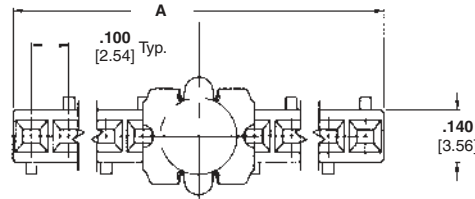

Recommended PC Board Pad Pattern (.008 [0.20] thick stencil)

Related Product Data

Mateable Headers — Refer to Mating Post Selection Guide — page 90

Performance Specifications — page 186

| No. of Pos. | Dimensions | | Packaged in Tubes | | | Packaged in Tape & Reel | | |
|-------------|----------------|---------------|----------------------------|------------|------------|----------------------------|------------|------------|
| | A | B | Contact Plating/ Part Nos. | | | Contact Plating/ Part Nos. | | |
| | | | Plating A | Plating B | Plating C | Plating A | Plating B | Plating C |
| 3 | .300 [7.62] | .200 [5.08] | 5-147738-2 | 5-147737-2 | 5-147736-2 | 5-147723-2 | 5-147728-2 | 5-147729-2 |
| 4 | .400 [10.16] | .300 [7.62] | 5-147738-3 | 5-147737-3 | 5-147736-3 | 5-147723-3 | 5-147728-3 | 5-147729-3 |
| 5 | .500 [12.70] | .400 [10.16] | 5-147738-4 | 5-147737-4 | 5-147736-4 | 5-147723-4 | 5-147728-4 | 5-147729-4 |
| 6 | .600 [15.24] | .500 [12.70] | 5-147738-5 | 5-147737-5 | 5-147736-5 | 5-147723-5 | 5-147728-5 | 5-147729-5 |
| 7 | .700 [17.78] | .600 [15.24] | 5-147738-6 | 5-147737-6 | 5-147736-6 | 5-147723-6 | 5-147728-6 | 5-147729-6 |
| 8 | .800 [20.32] | .700 [17.78] | 5-147738-7 | 5-147737-7 | 5-147736-7 | 5-147723-7 | 5-147728-7 | 5-147729-7 |
| 9 | .900 [22.86] | .800 [20.32] | 5-147738-8 | 5-147737-8 | 5-147736-8 | 5-147723-8 | 5-147728-8 | 5-147729-8 |
| 10 | 1.000 [25.40] | .900 [22.86] | 5-147738-9 | 5-147737-9 | 5-147736-9 | 5-147723-9 | 5-147728-9 | 5-147729-9 |
| 11 | 1.100 [27.94] | 1.000 [25.40] | 6-147738-0 | 6-147737-0 | 6-147736-0 | 6-147723-0 | 6-147728-0 | 6-147729-0 |
| 12 | 1.200 [30.48] | 1.100 [27.94] | 6-147738-1 | 6-147737-1 | 6-147736-1 | 6-147723-1 | 6-147728-1 | 6-147729-1 |
| 13 | 1.300 [33.02] | 1.200 [30.48] | 6-147738-2 | 6-147737-2 | 6-147736-2 | 6-147723-2 | 6-147728-2 | 6-147729-2 |
| 14 | 1.400 [35.56] | 1.300 [33.02] | 6-147738-3 | 6-147737-3 | 6-147736-3 | 6-147723-3 | 6-147728-3 | 6-147729-3 |
| 15 | 1.500 [38.10] | 1.400 [35.56] | 6-147738-4 | 6-147737-4 | 6-147736-4 | 6-147723-4 | 6-147728-4 | 6-147729-4 |
| 16 | 1.600 [40.64] | 1.500 [38.10] | 6-147738-5 | 6-147737-5 | 6-147736-5 | 6-147723-5 | 6-147728-5 | 6-147729-5 |
| 17 | 1.700 [43.18] | 1.600 [40.64] | 6-147738-6 | 6-147737-6 | 6-147736-6 | 6-147723-6 | 6-147728-6 | 6-147729-6 |
| 18 | 1.800 [45.72] | 1.700 [43.18] | 6-147738-7 | 6-147737-7 | 6-147736-7 | 6-147723-7 | 6-147728-7 | 6-147729-7 |
| 19 | 1.900 [48.26] | 1.800 [45.72] | 6-147738-8 | 6-147737-8 | 6-147736-8 | 6-147723-8 | 6-147728-8 | 6-147729-8 |
| 20 | 2.000 [50.80] | 1.900 [48.26] | 6-147738-9 | 6-147737-9 | 6-147736-9 | 6-147723-9 | 6-147728-9 | 6-147729-9 |
| 30 | 3.000 [76.20] | 2.900 [73.66] | 7-147738-9 | 7-147737-9 | 7-147736-9 | 7-147723-9 | 7-147728-9 | 7-147729-9 |
| 40 | 4.000 [101.60] | 3.900 [99.06] | 8-147738-9 | 8-147737-9 | 8-147736-9 | 8-147723-9 | 8-147728-9 | 8-147729-9 |

- Notes:** 1. TE recommends mating gold or duplex plated headers with duplex plated receptacle assemblies.
 2. To obtain the minimum mating post length, add .020 [0.51] (not including the post lead in chamfer) to the maximum point-of-contact dimension, and .062 [1.57] for recommended board thickness if used in bottom entry application.

Note: All part numbers are RoHS compliant.

Mod IV Surface Mount Receptacle Assemblies, Double-Row, .100 x .100 [2.54 x 2.54] Centers

Surface Mount, Double Row, Dual Entry with Holddowns

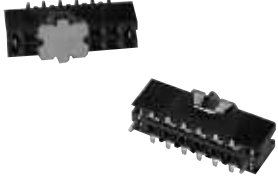

Material and Finish

Housing — Glass-filled thermoplastic, black, 94V-0 rated

Contacts — Phosphor bronze, plated as follows:

Plating A — Duplex .000030 [0.00076] gold on contact area, .000150-.000300 [0.00381-0.00762] matte tin on solder area all over .000050 [0.00127] nickel

Plating B — Duplex .000010 [0.000254] gold on contact area, .000150-.000300 [0.00381-0.00762] matte tin on solder area all over .000050 [0.00127] nickel

Plating C — .000150-.000300 [0.00381-0.00762] matte tin on solder leads, all over .000050 [0.00127] nickel

Related Product Data

Mateable Headers — Refer to Mating Post Selection Guide — page 90

Performance Specifications — page 186

Technical Documents — page 276

Product Specification
108-25022

Application Specification
114-25018

Additional receptacle assembly sizes are available; minimum order quantities may apply. Consult TE.

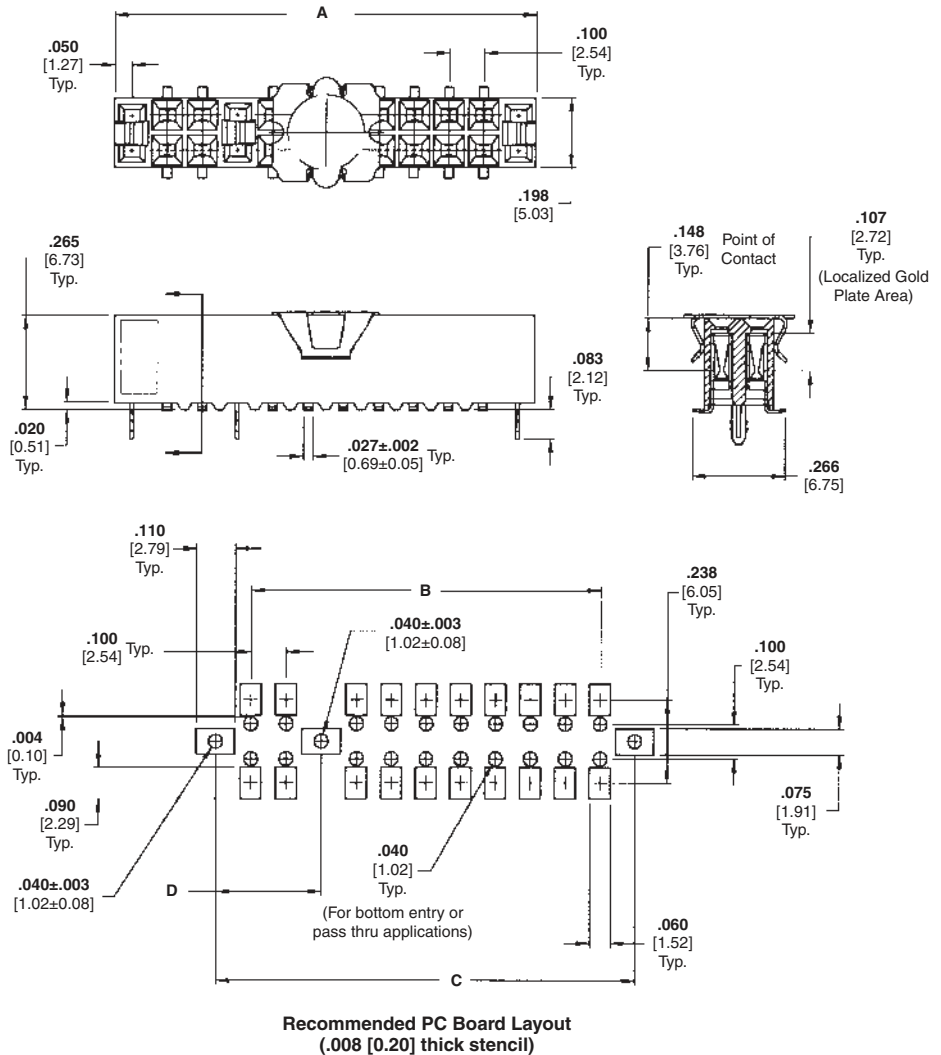

Keying Plug

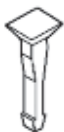

Part No. 86286-1
(Plugs into receptacle contact)

Material — Natural color nylon

Note: All part numbers are RoHS compliant.

**Mod IV Surface Mount Receptacle Assemblies, Double-Row,
.100 x .100 [2.54 x 2.54] Centers (Continued)**

| No. of Pos. | Dimensions | | | | D | Packaged in Tubes | | | Packaged in Tape and Reel | | |
|-------------|----------------|---------------|----------------|---------------|------------|---------------------------|------------|------------|---------------------------|------------|-----------|
| | A | B | C | See Note 1 | | Contact Plating/Part Nos. | | | Contact Plating/Part Nos. | | |
| | | | | | | Plating A | Plating B | Plating C | Plating A | Plating B | Plating C |
| 10 | .700 [17.78] | .400 [10.16] | .600 [15.24] | See Note 1 | 5-147102-5 | 5-147101-5 | 5-147103-5 | 5-147747-5 | 5-147746-5 | 5-147745-5 | |
| 14 | .900 [22.86] | .600 [15.24] | .800 [20.32] | See Note 1 | 5-147102-7 | 5-147101-7 | 5-147103-7 | 5-147747-7 | 5-147746-7 | 5-147745-7 | |
| 20 | 1.200 [30.48] | .900 [22.86] | 1.100 [27.94] | See Note 1 | 6-147102-0 | 6-147101-0 | 6-147103-0 | 6-147747-0 | 6-147746-0 | 6-147745-0 | |
| 22 | 1.300 [33.02] | 1.000 [25.40] | 1.200 [30.48] | See Note 1 | 6-147102-1 | 6-147101-1 | 6-147103-1 | 6-147747-1 | 6-147746-1 | 6-147745-1 | |
| 26 | 1.500 [38.10] | 1.200 [30.48] | 1.400 [35.56] | See Note 1 | 6-147102-3 | 6-147101-3 | 6-147103-3 | 6-147747-3 | 6-147746-3 | 6-147745-3 | |
| 30 | 1.700 [43.18] | 1.400 [35.56] | 1.600 [40.64] | See Note 1 | 6-147102-5 | 6-147101-5 | 6-147103-5 | 6-147747-5 | 6-147746-5 | 6-147745-5 | |
| 34 | 1.900 [48.26] | 1.600 [40.64] | 1.800 [45.72] | See Note 1 | 6-147102-7 | 6-147101-7 | 6-147103-7 | 6-147747-7 | 6-147746-7 | 6-147745-7 | |
| 36 | 2.000 [50.08] | 1.700 [43.18] | 1.900 [48.26] | See Note 1 | 6-147102-8 | 6-147101-8 | 6-147103-8 | 6-147747-8 | 6-147746-8 | 6-147745-8 | |
| 40 | 2.200 [55.88] | 1.900 [48.26] | 2.100 [53.34] | See Note 1 | 7-147102-0 | 7-147101-0 | 7-147103-0 | 7-147747-0 | 7-147746-0 | 7-147745-0 | |
| 46 | 2.500 [63.50] | 2.200 [55.88] | 2.400 [60.96] | See Note 1 | 7-147102-3 | 7-147101-3 | 7-147103-3 | 7-147747-3 | 7-147746-3 | 7-147745-3 | |
| 50 | 2.700 [68.58] | 2.400 [60.96] | 2.600 [66.04] | See Note 1 | 7-147102-5 | 7-147101-5 | 7-147103-5 | 7-147747-5 | 7-147746-5 | 7-147745-5 | |
| 62 | 3.300 [83.82] | 3.000 [76.20] | 3.200 [81.28] | See Note 1 | 8-147102-1 | 8-147101-1 | 8-147103-1 | 8-147747-1 | 8-147746-1 | 8-147745-1 | |
| 64 | 3.400 [86.36] | 3.100 [78.74] | 3.300 [83.82] | See Note 1 | 8-147102-2 | 8-147101-2 | 8-147103-2 | 8-147747-2 | 8-147746-2 | 8-147745-2 | |
| 66 | 3.500 [88.90] | 3.200 [81.28] | 3.400 [86.36] | See Note 1 | 8-147102-3 | 8-147101-3 | 8-147103-3 | 8-147747-3 | 8-147746-3 | 8-147745-3 | |
| 70 | 3.700 [95.98] | 3.400 [86.36] | 3.600 [91.44] | See Note 1 | 8-147102-5 | 8-147101-5 | 8-147103-5 | 8-147747-5 | 8-147746-5 | 8-147745-5 | |
| 80 | 4.300 [109.22] | 3.900 [99.06] | 4.200 [106.68] | 2.100 [53.34] | 9-147102-0 | 9-147101-0 | 9-147103-0 | 9-147747-0 | 9-147746-0 | 9-147745-0 | |

- Notes:** 1. No center holddown.
2. To obtain the minimum mating post length, add .020 [0.51] (not including the post lead in chamfer) to the maximum point-of-contact dimension and .062 [1.57] for recommended board thickness in bottom entry applications.

Note: All part numbers are RoHS compliant.

Mod IV Surface Mount Receptacle Assemblies, Double-Row, .100 x .100 [2.54 x 2.54] Centerline

Surface Mount, Double Row, Dual Entry End to End Stackable

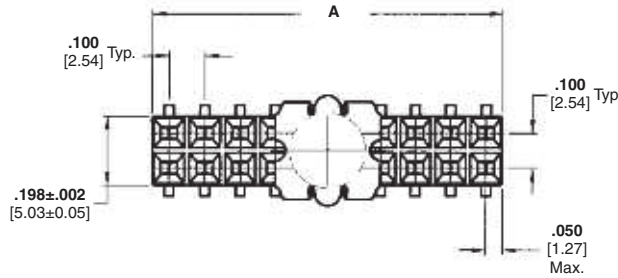
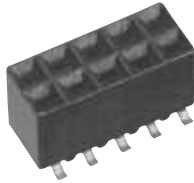

Material and Finish

Housing — Glass-filled thermoplastic, black, 94V-0 rated

Contacts — Phosphor bronze, plated as follows:

Plating A — Duplex .000030 [0.00076] gold on contact area, .000150-.000300 [0.00381-0.00762] matte tin on solder area all over .000050 [0.00127] nickel

Plating B — Duplex .000010 [0.000254] gold on contact area, .000150-.000300 [0.00381-0.00762] matte tin on solder area all over .000050 [0.00127] nickel

Plating C — .000150-.000300 [0.00381-0.00762] tin-lead over .000050 [0.00127] nickel

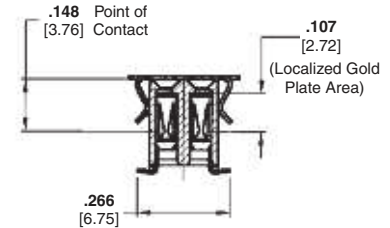
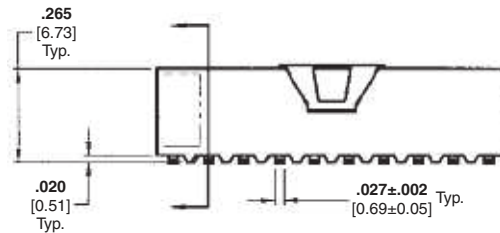

Related Product Data

Mateable Headers — Refer to Mating Post Selection Guide — page 90

Performance Specifications — page 186

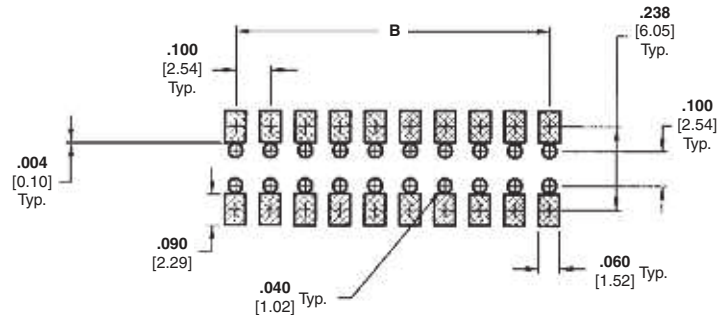

Recommended PC Board Pad Layout
(.008 [0.20] thick stencil)
(for Bottom Entry and Pass Through applications)

Technical Documents — page 276

Product Specification
108-25022

Application Specification
114-25018

Additional receptacle assembly sizes are available; minimum order quantities may apply. Consult TE.

Keying Plug

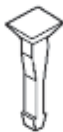

Part No. 86286-1
(Plugs into receptacle contact)

Material — Natural color nylon

Note: All part numbers are RoHS compliant.

**Mod IV Surface Mount Receptacle Assemblies, Double-Row,
.100 x .100 [2.54 x 2.54] Centerline** (Continued)

| No. of Pos. | Dimensions | | Packaged in Tubes | | | Packaged in Tape & Reel | | |
|-------------|----------------|---------------|----------------------------|------------|------------|----------------------------|------------|------------|
| | A | B | Contact Plating/ Part Nos. | | | Contact Plating/ Part Nos. | | |
| | | | Plating A | Plating B | Plating C | Plating A | Plating B | Plating C |
| 10 | .500 [12.70] | .400 [10.16] | 5-147741-5 | 5-147740-5 | 5-147739-5 | 5-147105-5 | 5-147104-5 | 5-147106-5 |
| 14 | .700 [17.78] | .600 [15.24] | 5-147741-7 | 5-147740-7 | 5-147739-7 | 5-147105-7 | 5-147104-7 | 5-147106-7 |
| 20 | 1.000 [25.40] | .900 [22.86] | 6-147741-0 | 6-147740-0 | 6-147739-0 | 6-147105-0 | 6-147104-0 | 6-147106-0 |
| 22 | 1.100 [27.94] | 1.000 [25.40] | 6-147741-1 | 6-147740-1 | 6-147739-1 | 6-147105-1 | 6-147104-1 | 6-147106-1 |
| 26 | 1.300 [33.02] | 1.200 [30.48] | 6-147741-3 | 6-147740-3 | 6-147739-3 | 6-147105-3 | 6-147104-3 | 6-147106-3 |
| 30 | 1.500 [38.10] | 1.400 [35.56] | 6-147741-5 | 6-147740-5 | 6-147739-5 | 6-147105-5 | 6-147104-5 | 6-147106-5 |
| 34 | 1.700 [43.18] | 1.600 [40.64] | 6-147741-7 | 6-147740-7 | 6-147739-7 | 6-147105-7 | 6-147104-7 | 6-147106-7 |
| 36 | 1.800 [45.72] | 1.700 [43.18] | 6-147741-8 | 6-147740-8 | 6-147739-8 | 6-147105-8 | 6-147104-8 | 6-147106-8 |
| 40 | 2.000 [50.80] | 1.900 [48.26] | 7-147741-0 | 7-147740-0 | 7-147739-0 | 7-147105-0 | 7-147104-0 | 7-147106-0 |
| 46 | 2.300 [58.42] | 2.200 [55.88] | 7-147741-3 | 7-147740-3 | 7-147739-3 | 7-147105-3 | 7-147104-3 | 7-147106-3 |
| 50 | 2.500 [63.50] | 2.400 [60.96] | 7-147741-5 | 7-147740-5 | 7-147739-5 | 7-147105-5 | 7-147104-5 | 7-147106-5 |
| 62 | 3.100 [78.74] | 3.000 [76.20] | 8-147741-1 | 8-147740-1 | 8-147739-1 | 8-147105-1 | 8-147104-1 | 8-147106-1 |
| 64 | 3.200 [81.28] | 3.100 [78.74] | 8-147741-2 | 8-147740-2 | 8-147739-2 | 8-147105-2 | 8-147104-2 | 8-147106-2 |
| 66 | 3.300 [83.82] | 3.200 [81.28] | 8-147741-3 | 8-147740-3 | 8-147739-3 | 8-147105-3 | 8-147104-3 | 8-147106-3 |
| 70 | 3.500 [88.90] | 3.400 [86.36] | 8-147741-5 | 8-147740-5 | 8-147739-5 | 8-147105-5 | 8-147104-5 | 8-147106-5 |
| 80 | 4.000 [101.60] | 3.900 [99.06] | 9-147741-0 | 9-147740-0 | 9-147739-0 | 9-147105-0 | 9-147104-0 | 9-147106-0 |

Notes: 1. To obtain the minimum mating post length, add .020 [0.51] (not including the post lead in chamfer) to the maximum point-of-contact dimension and .062 [1.57] for recommended board thickness in bottom entry applications.

Note: All part numbers are RoHS compliant.

Two-Piece Printed Circuit Board Connectors

Product Facts

- Two-Piece reliability
- Two- and three-row systems available
- Short signal path for VLSI applications
- Receptacles employ dual cantilever beams and built-in anti-overstress to provide reliable connections
- Built-in guides provide alignment before contact engagement
- Closed entry receptacle housings provide lead-in ramp for positive mating of contacts
- Shrouded headers provide full pin protection
- Polarized headers
- Vertical headers available with ACTION PIN posts or .025 [0.64] square solder posts
- Repairable ACTION PIN posts
- Simple seating tooling for headers with ACTION PIN posts
- Recognized under the Component Program of Underwriters Laboratories Inc., File No. E28476
- Certified by Canadian Standards Association, File No. LR 7189

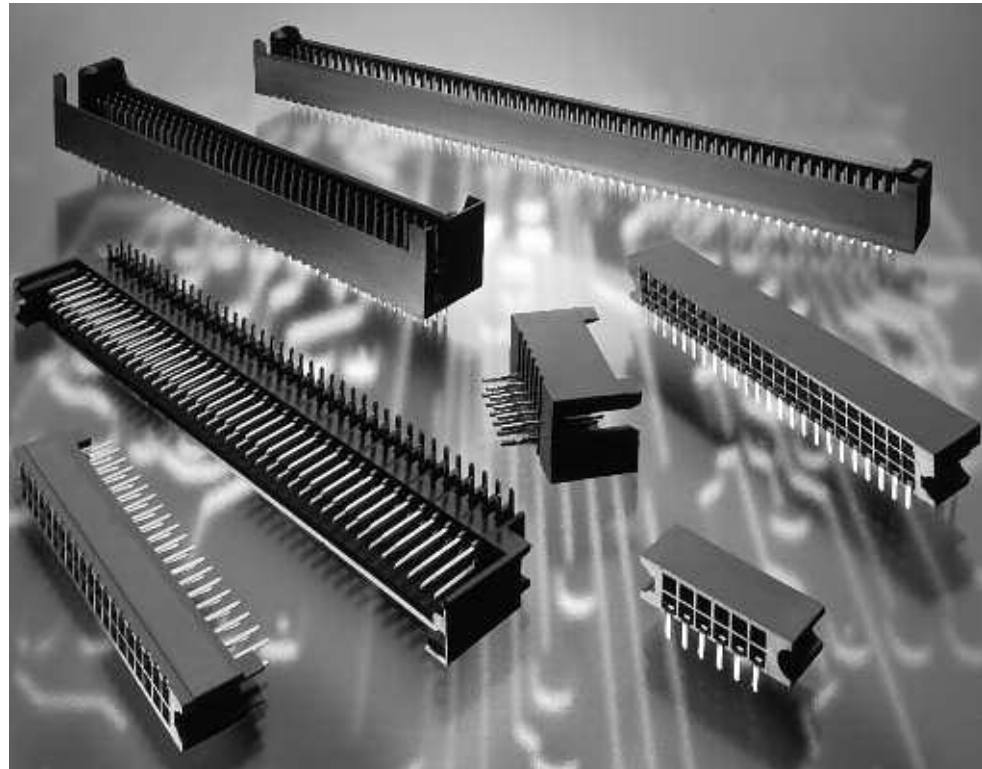

ACTION PIN Posts



Solder Posts



Receptacle Contact
(Double Beam with Anti-Overstress)
Board Retention Feature Available

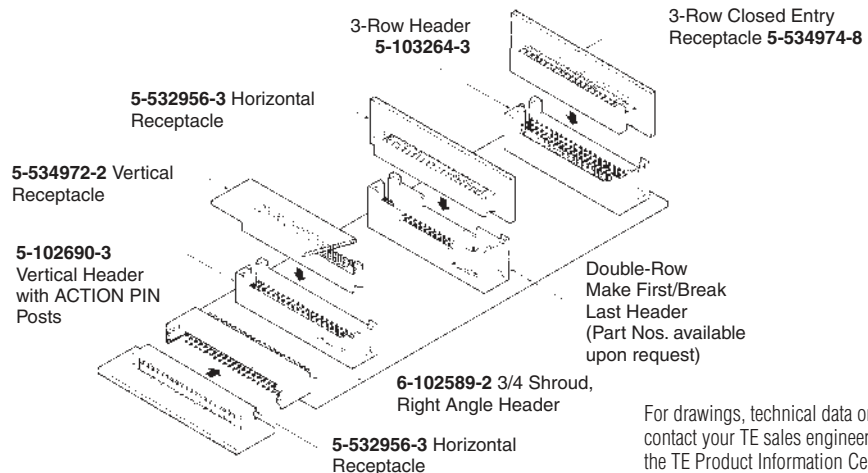

Note: All part numbers are RoHS compliant.

For drawings, technical data or samples, contact your TE sales engineer or call the TE Product Information Center: 1-800-522-6752

Two-Piece Printed Circuit Board Connectors (Continued)

AMPMODU Two-Piece Printed Circuit Board connectors are designed to reliably and economically meet the packaging and interconnection requirements of today's sophisticated electronics.

The double row system is produced in 10 thru 200 positions in the vertical headers and horizontal receptacles, and 10 thru 160 positions in the right angle headers and vertical receptacles.

The AMPMODU three-row connector system is produced in 30 through 300 positions (straight post headers and mating horizontal receptacles).

Both two- and three-row vertical headers are available with press-fit ACTION PIN posts or standard .025 [0.64] square solder posts. There is a simple seating tool for headers with ACTION PIN posts.

A board retention feature is offered in the two-row horizontal receptacles, two-row right angle headers and two- and three-row vertical headers. Built-in guides assure accurate header and receptacle alignment before contact engagement.

Closed entry receptacle housings provide a lead-in ramp for positive mating of contacts.

Performance Specifications

- Current Rating** — 3 amperes max. for single contact; 2 amperes max. per contact for fully energized connector
- Voltage Rating** — 250 VAC
- Dielectric Rating** — 750 VAC rms between contacts for one minute
- Termination Resistance** — 12 milliohms max. at 100 milliamperes test current, and 50 millivolts open circuit voltage
- Insulation Resistance** — 1000 megohms after temperature/humidity cycling

- Temperature Rating** — Headers and Receptacles — -65°C to +125°C (black thermoplastic housings, 94V-0 rated)
- Durability (Tested to)** — 200 cycles for .000030 [0.00076] gold plating; 75 cycles for .000015 [0.00038] gold plating
- Mating Force** — 8 oz. [2.22N] maximum per contact
- Unmating Force** — .75 oz. [0.2N] minimum per contact during third mating cycle

Receptacle Assemblies, Board Mount, Double-Row, Closed Entry, .100 x .100 [2.54 x 2.54] Centerline

Horizontal Mount (with Guide Pin Slots and Standoffs)



Material and Finish

Housing — Glass-filled thermoplastic, black, 94V-0 rated

Contacts — Phosphor bronze, plated as follows:

Plating A — Duplex plated .000030 [0.00076] gold on contact area, .000050-.000100 [0.00127-0.00254] matte tin on solder area, with entire contact underplated .000050 [0.00127] nickel

Plating B — Duplex plated .000015 [0.00038] gold on contact area, .000050-.000100 [0.00127-0.00254] matte tin on solder area, with entire contact underplated .000050 [0.00127] nickel

Related Product Data

Mateable Headers — pages 198, 199

Performance Specifications — page 194

Technical Documents — page 276

Product Specification

108-25017

Application Specification

114-9009

Additional receptacle assembly sizes and solder tail lengths are available; minimum order quantities may apply. Consult TE.

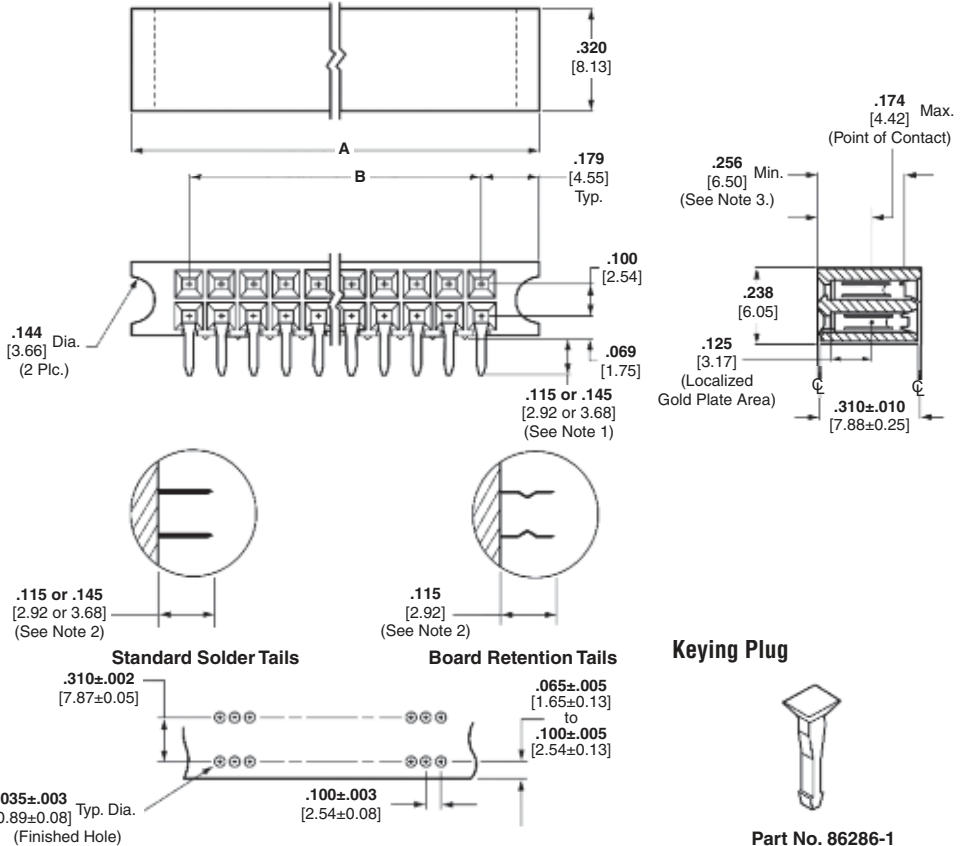

Recommended PC Board Hole Layout (for .055 [1.40] min. thick PC board)

Tolerances not to accumulate within one connector pattern.

Keying Plug

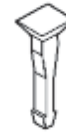

Part No. 86286-1

(Plugs into receptacle contact)

Material — Natural color nylon

| No. of Pos. | Dimensions | | Receptacle Assembly Part Nos. with .115 [2.92] Solder Tail Lengths | | | | Receptacle Assembly Part Nos. with .145 [3.68] Solder Tail Lengths |
|-------------|-----------------|----------------|--|------------|-----------------------|------------|--|
| | A | B | Standard Solder Tails | | Board Retention Tails | | Standard Solder Tails |
| | | | Plating A | Plating B | Plating A | Plating B | |
| 12 | .858 [21.79] | .500 [12.70] | 5-532956-1 | 5-532955-1 | 5-534204-2 | 5-534975-5 | 5-533009-1 |
| 14 | .958 [24.33] | .600 [15.24] | — | 7-532955-5 | — | — | — |
| 16 | 1.058 [26.87] | .700 [17.78] | 5-532956-2 | — | 6-534204-0 | 6-534975-5 | — |
| 20 | 1.258 [31.95] | .900 [22.86] | 5-532956-3 | 5-532955-3 | 5-534204-9 | 5-534975-6 | — |
| 24 | 1.458 [37.03] | 1.100 [27.94] | 5-532956-4 | 5-532955-4 | 6-534204-1 | 5-534975-7 | — |
| 30 | 1.758 [44.65] | 1.400 [35.56] | 5-532956-5 | 5-532955-5 | 5-534204-4 | 5-534975-8 | 5-533009-5 |
| 36 | 2.058 [52.27] | 1.700 [43.18] | 5-532956-6 | 5-532955-6 | 5-534204-3 | 5-534975-9 | — |
| 40 | 2.258 [57.35] | 1.900 [48.26] | 5-532956-7 | 5-532955-7 | 6-534204-2 | 6-534975-0 | — |
| 50 | 2.758 [70.05] | 2.400 [60.96] | 5-532956-8 | 5-532955-8 | 5-534204-1 | 6-534975-1 | 5-533009-8 |
| 60 | 3.258 [82.75] | 2.900 [73.66] | 5-532956-9 | 5-532955-9 | 5-534204-5 | 6-534975-2 | 5-533009-9 |
| 70 | 3.758 [95.45] | 3.400 [86.36] | 6-532956-0 | 6-532955-0 | 6-534204-3 | 6-534975-3 | 6-533009-0 |
| 72 | 3.858 [97.99] | 3.500 [88.90] | 6-532956-1 | 6-532955-1 | 6-534204-4 | — | — |
| 80 | 4.258 [108.15] | 3.900 [99.06] | 6-532956-2 | 6-532955-2 | 5-534204-8 | 6-534975-4 | 6-533009-2 |
| 86 | 4.558 [115.77] | 4.200 [106.68] | 6-532956-3 | 6-532955-3 | — | — | 6-533009-3 |
| 90 | 4.758 [120.85] | 4.400 [111.76] | 6-532956-4 | 6-532955-4 | — | — | — |
| 96 | 5.058 [128.47] | 4.700 [119.38] | 6-532956-5 | 6-532955-5 | 6-534204-5 | — | 6-533009-5 |
| 100 | 5.258 [133.55] | 4.900 [124.46] | 6-532956-6 | 6-532955-6 | 5-534204-6 | 5-534975-1 | 6-533009-6 |
| 110 | 5.758 [146.25] | 5.400 [137.16] | 6-532956-7 | 6-532955-7 | 6-534204-6 | — | — |
| 120 | 6.258 [158.95] | 5.900 [149.86] | 6-532956-8 | 6-532955-8 | 5-534204-7 | 5-534975-2 | 6-533009-8 |
| 130 | 6.758 [171.65] | 6.400 [162.56] | 7-532956-0 | 7-532955-0 | 6-534204-7 | — | — |
| 200 | 10.258 [260.55] | 9.900 [251.46] | 7-532956-3 | 7-532955-3 | 7-534204-0 | 5-534975-4 | — |

- Notes:** 1. .115 [2.92] tail length is for use with .062 [1.57] PC boards; .145 [3.68] tail length is for use with .093 [2.36] PC boards.
 2. Receptacle assemblies with low force contacts are available, consult TE.
 3. .256 [6.50] minimum positive pin stop to prevent shorting between rows.

Note: All part numbers are RoHS compliant.

Receptacle Assemblies, Board Mount, Double-Row, Closed Entry, .100 x .100 [2.54 x 2.54] Centerline (Continued)

Vertical Mount (with Guide Pin Slots and Standoffs)

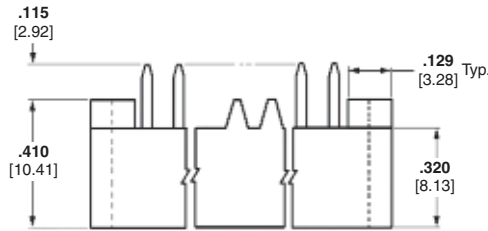
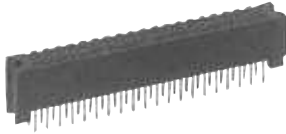

Material and Finish

Housing — Glass-filled thermoplastic, black, 94V-0 rated

Contacts — Phosphor bronze, duplex plated .000030 [0.00076] gold on contact area, .000050-.000100 [0.00127-0.00254] matte tin on solder area, with entire contact underplated .000050 [0.00127] nickel

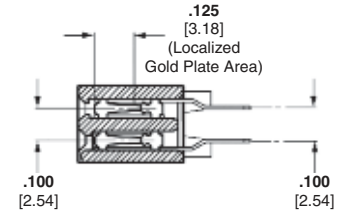
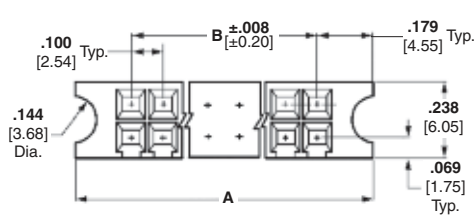

Related Product Data

Mateable Headers — pages 198, 199

Performance Specifications — page 194

Technical Documents — page 276

Product Specification
108-25017

Application Specification
114-9009

Additional receptacle assembly sizes and solder tail lengths are available; minimum order quantities may apply. Consult TE.

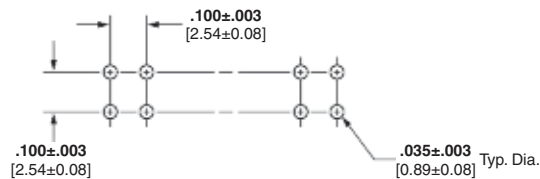

Recommended PC Board Hole Layout (for .055 [1.40] min. thick PC board)

Tolerances not to accumulate within one connector pattern.

Keying Plug

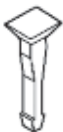

Part No. 86286-1

(Plugs into receptacle contact)

Material — Natural color nylon

| No. of Pos. | Dimensions | | Receptacle Assembly Part Nos. |
|-------------|----------------|----------------|-------------------------------|
| | A | B | |
| 30 | 1.758 [44.65] | 1.400 [35.56] | 5-534972-1 |
| 40 | 2.258 [57.35] | 1.900 [48.26] | 5-534972-2 |
| 50 | 2.758 [70.05] | 2.400 [60.96] | 5-534972-3 |
| 60 | 3.258 [82.75] | 2.900 [73.66] | 5-534972-4 |
| 70 | 3.758 [95.45] | 3.400 [86.36] | 5-534972-5 |
| 80 | 4.258 [108.15] | 3.900 [99.06] | 5-534972-6 |
| 90 | 4.758 [120.85] | 4.400 [111.76] | 5-534972-7 |
| 100 | 5.258 [133.55] | 4.900 [124.46] | 5-534972-8 |
| 120 | 6.258 [158.95] | 5.900 [149.86] | 6-534972-0 |

Note: All part numbers are RoHS compliant.

Receptacle Assemblies, Board Mount, Triple-Row, Closed Entry, .100 x .100 [2.54 x 2.54] Centerline

Horizontal Mount (with Guide Pin Slots and Standoffs)

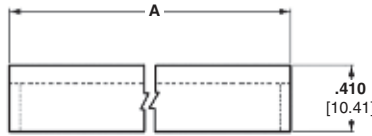

Material and Finish

Housing — Glass-filled thermoplastic, black, 94V-0 rated

Contacts — Phosphor bronze, plated .000030 [0.00076] gold in mating area, .000050-.000100 [0.00127-0.00254] matte tin on solder area, with entire contact underplated .000050 [0.00127] nickel

Related Product Data

Mateable Headers — page 201

Performance Specifications — page 194

Technical Documents — page 276

Product Specification
108-25017

Application Specification
114-9009

Additional receptacle assembly sizes and solder tail lengths are available; minimum order quantities may apply. Consult TE.

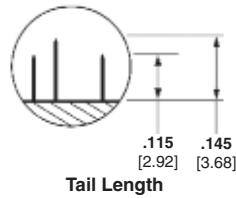
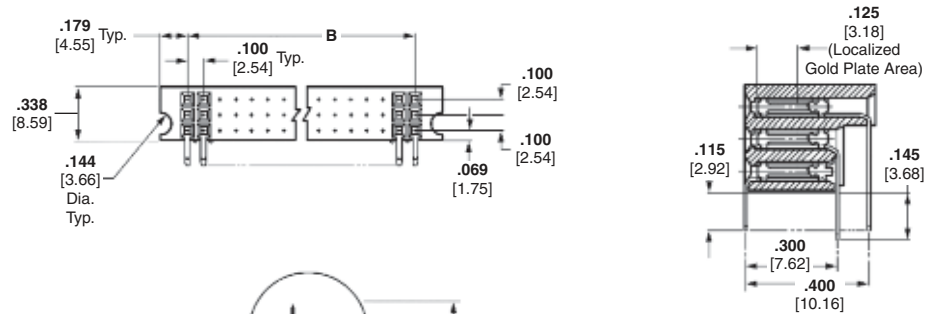

Tail Length

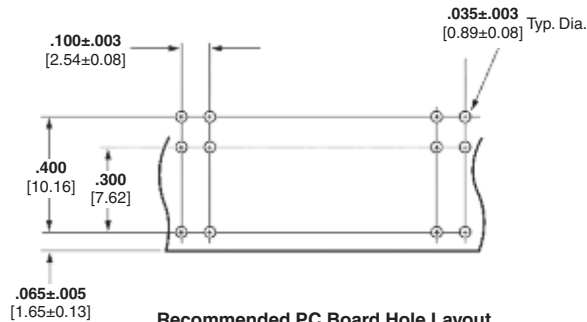

Recommended PC Board Hole Layout
(for .055 [1.40] min. thick PC board)

Tolerances not to accumulate within one connector pattern.

Keying Plug

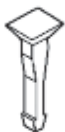

Part No. 86286-1

(Plugs into receptacle contact)

Material — Natural color nylon

| No. of Pos. | Dimensions | | Receptacle Assembly Part Nos. Plating A |
|-------------|----------------|----------------|--|
| | A | B | |
| 72 | 2.658 [67.51] | 2.300 [58.42] | 5-534974-3 |
| 93 | 3.358 [85.29] | 3.000 [76.20] | 5-534974-4 |
| 96 | 3.458 [87.83] | 3.100 [78.74] | 5-534974-5 |
| 150 | 5.258 [133.55] | 4.900 [124.46] | 5-534974-8 |
| 210 | 7.258 [184.35] | 6.900 [175.26] | 6-534974-1 |

Note: All part numbers are RoHS compliant.

Headers, Straight Post, Double-Row, .100 x .100 [2.54 x 2.54] Centerline

Solder Posts and ACTION PIN Posts (with Pin Protection and Guide Pins)



Material and Finish

Housing — Glass-filled thermoplastic, black, 94V-0 rated

Posts — Phosphor bronze, plated as follows:

Plating A — Duplex plated .000030 [0.00076] gold on contact area, .000100-.000200 [0.00254-0.00508] matte tin on termination end, with entire post underplated .000050 [0.00127] nickel

Plating B — Duplex plated .000015 [0.00038] gold on contact area, .000100-.000200 [0.00254-0.00508] matte tin on termination end, with entire post underplated .000050 [0.00127] nickel

Plating C — Selectively plated .000030 [0.00076] gold on contact area and .000015 [0.00038] gold on termination end, with gold flash over .000050 [0.00127] nickel on entire post

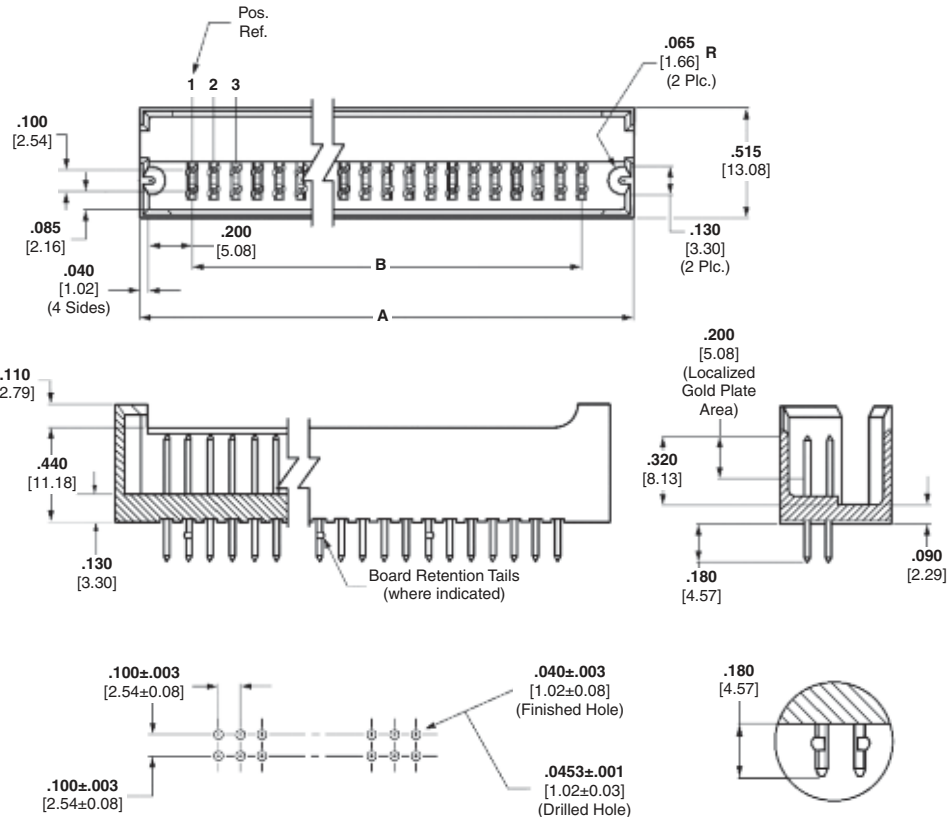

Recommended PC Board Hole Layout (for .055 [1.40] min. thick PC board)

Tolerances not to accumulate within one connector pattern.

Related Product Data

Mateable Receptacles — pages 195, 196

Performance Specifications — page 194

ACTION PIN Posts — pages 150, 151

Application Tooling — pages 152

Technical Documents — page 276

Product Specification

108-25017

Application Specification

114-9009

Additional header sizes are available; minimum order quantities may apply. Consult TE.

| No. of Pos. | Dimensions | | Header Part Nos. with .180 [4.57] Tail Length | | | |
|-------------|-----------------|----------------|---|------------|-----------------------|------------|
| | A | B | Standard Solder Tails | | Board Retention Tails | |
| | | | Plating A | Plating B | Plating A | Plating B |
| 12 | .980 [24.89] | .500 [12.70] | 5-102692-1 | 5-102567-1 | 6-534978-6 | 5-534257-5 |
| 14 | 1.080 [27.43] | .600 [15.24] | — | 7-102567-3 | — | — |
| 16 | 1.180 [29.97] | .700 [17.78] | 6-102692-5 | — | 5-534978-2 | 6-534257-4 |
| 20 | 1.380 [35.05] | .900 [22.86] | 6-102692-6 | 6-102567-1 | 5-534978-3 | 5-534257-6 |
| 24 | 1.580 [40.13] | 1.100 [27.94] | 5-102692-2 | 5-102567-2 | 5-534978-4 | 5-534257-7 |
| 30 | 1.880 [47.75] | 1.400 [35.56] | 6-102692-7 | 6-102567-3 | 5-534978-5 | 5-534257-8 |
| 36 | 2.180 [55.37] | 1.700 [43.18] | 5-102692-3 | 5-102567-3 | 5-534978-6 | 5-534257-9 |
| 40 | 2.380 [60.45] | 1.900 [48.26] | 6-102692-3 | 6-102567-2 | 5-534978-7 | 6-534257-0 |
| 50 | 2.880 [73.15] | 2.400 [60.96] | 5-102692-4 | 5-102567-6 | 5-534978-8 | 6-534257-5 |
| 60 | 3.380 [85.85] | 2.900 [73.66] | 5-102692-5 | 5-102567-4 | 5-534978-9 | 6-534257-1 |
| 70 | 3.880 [98.55] | 3.400 [86.36] | 6-102692-4 | 6-102567-0 | 6-534978-5 | 6-534257-2 |
| 72 | 3.980 [101.09] | 3.500 [88.90] | 6-102692-8 | 6-102567-6 | 6-534978-0 | — |
| 80 | 4.380 [111.25] | 3.900 [99.06] | 5-102692-6 | 5-102567-8 | 6-534978-1 | 5-534257-1 |
| 86 | 4.680 [118.87] | 4.200 [106.68] | 6-102692-9 | 6-102567-7 | — | — |
| 90 | 4.880 [123.95] | 4.400 [111.76] | 6-102692-2 | 6-102567-4 | — | — |
| 96 | 5.180 [131.57] | 4.700 [119.38] | 5-102692-7 | 5-102567-5 | 6-534978-7 | — |
| 100 | 5.380 [136.65] | 4.900 [124.46] | 5-102692-8 | 5-102567-9 | 6-534978-8 | 5-534257-2 |
| 110 | 5.880 [149.35] | 5.400 [137.16] | 6-102692-0 | 6-102567-5 | 6-534978-2 | — |
| 120 | 6.380 [162.05] | 5.900 [149.86] | 5-102692-9 | 5-102567-7 | 6-534978-3 | 5-534257-3 |
| 130 | 6.880 [174.75] | 6.400 [162.56] | 7-102692-0 | 6-102567-9 | 6-534978-9 | — |
| 200 | 10.380 [263.65] | 9.900 [251.46] | 6-102692-1 | 7-102567-1 | 5-534978-1 | 6-534257-9 |

Note: Headers with make first/break last posts can be made available, consult TE.

Note: All part numbers are RoHS compliant.

Printed Circuit Board Connectors

5

Headers, Straight Post, Double-Row, .100 x .100 [2.54 x 2.54] Centerline (Continued)

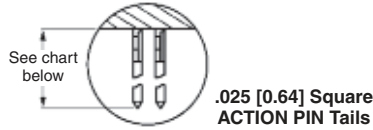

| No. of Pos. | Dimensions | | Header Part Nos. with ACTION PIN Posts | | | | |
|-------------|----------------|----------------|--|------------|--------------------------|------------|--------------------------|
| | A | B | .250 [6.35] Tail Length | | .480 [12.19] Tail Length | | .680 [17.27] Tail Length |
| | | | Plating A | Plating B | Plating A | Plating C | Plating C |
| 12 | .980 [24.89] | .500 [12.70] | 5-102690-1 | 5-103291-4 | — | — | — |
| 14 | 1.080 [27.43] | .600 [15.24] | — | 5-103291-3 | — | — | — |
| 20 | 1.380 [35.05] | .900 [22.86] | 6-102690-3 | 5-103291-6 | — | — | — |
| 24 | 1.580 [40.13] | 1.100 [27.94] | 5-102690-2 | 5-103291-7 | — | — | — |
| 36 | 2.180 [55.37] | 1.700 [43.18] | 5-102690-3 | 5-103291-9 | — | — | — |
| 40 | 2.380 [60.45] | 1.900 [48.26] | 6-102690-6 | 5-103291-2 | — | — | — |
| 50 | 2.880 [73.15] | 2.400 [60.96] | 5-102690-4 | 6-103291-0 | — | — | — |
| 60 | 3.380 [85.85] | 2.900 [73.66] | 5-102690-5 | 6-103291-1 | — | — | — |
| 70 | 3.880 [98.55] | 3.400 [86.36] | 6-102690-7 | 6-103291-2 | — | — | — |
| 80 | 4.380 [111.25] | 3.900 [99.06] | 5-102690-6 | 6-103291-4 | — | — | — |
| 90 | 4.880 [123.95] | 4.400 [111.76] | 6-102690-1 | 6-103291-6 | — | — | — |
| 96 | 5.180 [131.57] | 4.700 [119.38] | 5-102690-7 | 6-103291-8 | — | — | — |
| 100 | 5.380 [136.65] | 4.900 [124.46] | 5-102690-8 | 6-103291-9 | — | — | 102777-3 |
| 120 | 6.380 [162.05] | 5.900 [149.86] | 5-102690-9 | 7-103291-1 | 5-102691-9 | 1-102666-1 | 102777-1 |
| 130 | 6.880 [174.75] | 6.400 [162.56] | — | — | — | 102666-9 | — |

- Notes:** 1. Other header sizes can be made available upon request.
 Headers with ACTION PIN posts are for use with .093 [2.36] nominal or thicker PC boards.
 2. Application tooling for installing headers with ACTION PIN posts is shown on pages 152 and 153.
 3. Headers with .250 [6.35] tail length can be made available with make first/break last contacts, consult TE.
 4. Plated through holes to be prepared per recommendations found on page 151.

Note: All part numbers are RoHS compliant.

Headers, Right-Angle Post, Double-Row, .100 x .100 [2.54 x 2.54] Centerline

Card Extender (with Pin Protection and Guide Pins)



Material and Finish

Housing — Glass-filled thermoplastic, black, 94V-0 rated

Posts — Phosphor bronze, plated as follows:

Plating A — Duplex plated .000030 [0.00076] gold on contact area, .000100-.000200 [0.00254-0.00508] matte tin on termination end, with entire post underplated .000050 [0.00127] nickel

Plating B — Duplex plated .000015 [0.00038] gold on contact area, .000100-.000200 [0.00254-0.00508] matte tin on termination end, with entire post underplated .000050 [0.00127] nickel

Related Product Data

Mateable Receptacles — pages 195, 196

Performance Specifications — page 194

Technical Documents — page 276

Product Specification
108-25017

Application Specification
114-9009

Additional header sizes are available; minimum order quantities may apply. Consult TE.

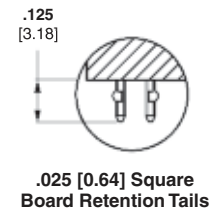
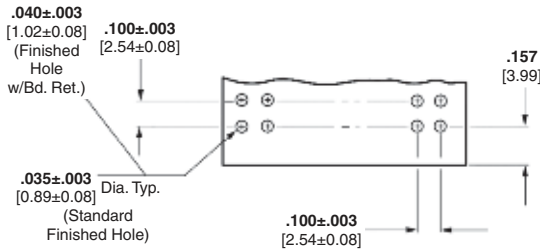
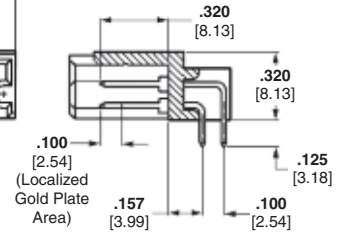
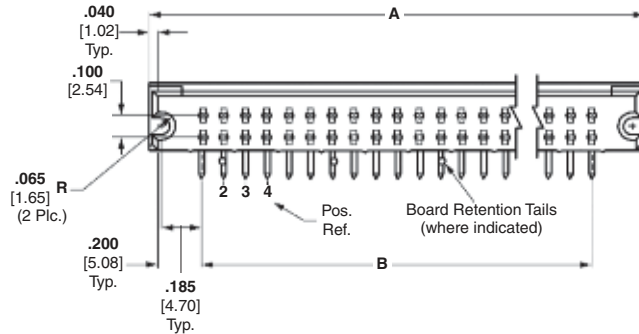

Recommended PC Board Hole Layout (for .055 [1.40] min. thick PC board)

Tolerances not to accumulate within one connector pattern.

| No. of Pos. | Dimensions | | Header Part Nos. with .125 [3.18] Tail Length | | |
|-------------|----------------|----------------|---|------------|-----------------------|
| | A | B | Standard Solder Tails | | Board Retention Tails |
| | | | Plating A | Plating B | Plating A |
| 12 | .980 [24.89] | .500 [12.70] | 6-102802-2 | 5-102589-8 | 5-534245-5 |
| 16 | 1.180 [29.97] | .700 [17.78] | 6-102802-4 | — | 5-534245-4 |
| 20 | 1.380 [35.05] | .900 [22.86] | 6-102802-5 | 6-102589-2 | 5-534245-6 |
| 24 | 1.580 [40.13] | 1.100 [27.94] | 6-102802-3 | 5-102589-6 | 5-534245-7 |
| 30 | 1.880 [47.75] | 1.400 [35.56] | 6-102802-6 | 5-102589-4 | 5-534245-2 |
| 36 | 2.180 [55.37] | 1.700 [43.18] | 5-102802-3 | 5-102589-2 | 5-534245-8 |
| 40 | 2.380 [60.45] | 1.900 [48.26] | 5-102802-8 | 6-102589-3 | — |
| 50 | 2.880 [73.15] | 2.400 [60.96] | 5-102802-4 | 5-102589-5 | 5-534245-1 |
| 60 | 3.380 [85.85] | 2.900 [73.66] | 5-102802-9 | 5-102589-7 | — |
| 72 | 3.980 [101.09] | 3.500 [88.90] | 6-102802-7 | 6-102589-7 | — |
| 80 | 4.380 [111.25] | 3.900 [99.06] | 5-102802-5 | 5-102589-1 | 6-534245-0 |
| 90 | 4.880 [123.95] | 4.400 [111.76] | 6-102802-0 | 6-102589-4 | — |
| 100 | 5.380 [136.65] | 4.900 [124.46] | 5-102802-6 | 5-102589-3 | 6-534245-1 |
| 120 | 6.380 [162.05] | 5.900 [149.86] | 5-102802-2 | 6-102589-1 | 5-534245-3 |
| 130 | 6.880 [174.75] | 6.400 [162.56] | 6-102802-9 | 6-102589-9 | 6-534245-3 |

Note: Headers with make first/break last posts can be made available, consult TE.

Note: All part numbers are RoHS compliant.

Headers, Straight Post, Triple-Row, .100 x .100 [2.54 x 2.54] Centerline

Solder Posts (with Pin Protection and Guide Pins)



Material and Finish

Housing — Glass-filled thermoplastic, black, 94V-0 rated

Posts — Phosphor bronze, plated as follows:

Plating A — Duplex plated .000030 [0.00076] gold on contact area, .000100-.000200 [0.00254-0.00508] matte tin on termination end, with entire post underplated .000050 [0.00127] nickel

Related Product Data

Mateable Receptacles — page 197

Performance Specifications — page 194

Technical Documents — page 276

Product Specification
108-25017

Application Specification
114-9009

Additional header assembly sizes are available; minimum order quantities may apply. Consult TE.

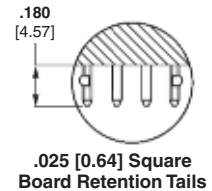
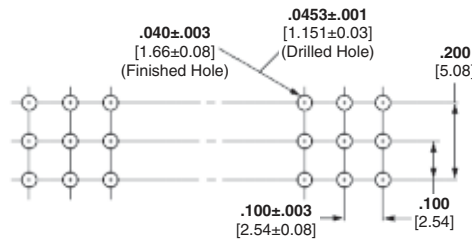
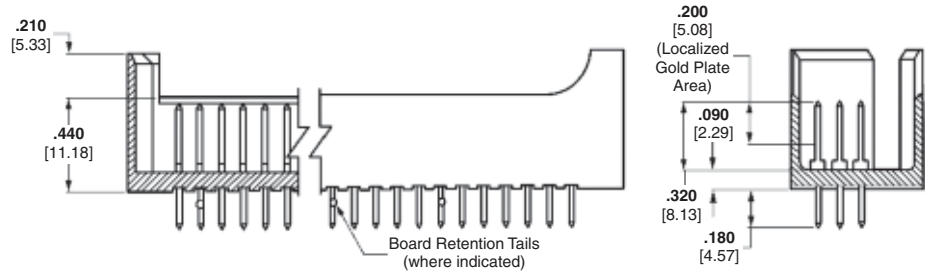
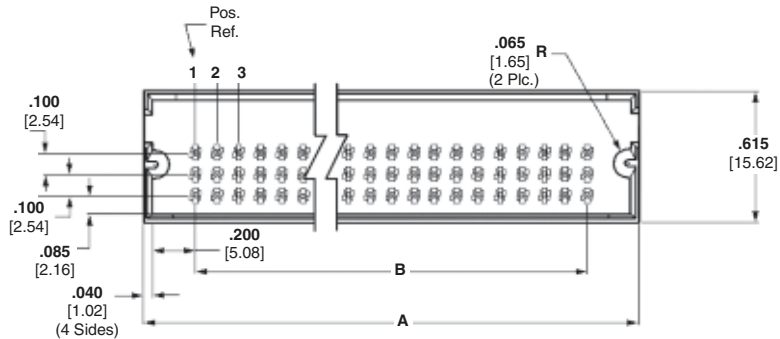

Recommended PC Board Hole Layout (for .055 [1.40] min. thick PC board)

Tolerances not to accumulate within one connector pattern.

| No. of Pos. | Dimensions | | Header Part Nos. with .180 [4.57] Tail Length | |
|-------------|----------------|----------------|---|---------------------------------|
| | A | B | Standard Solder Tails Plating A | Board Retention Tails Plating A |
| 72 | 2.780 [70.61] | 2.300 [58.42] | 5-103264-1 | 5-534258-1 |
| 96 | 3.480 [88.39] | 3.000 [76.20] | — | 5-534258-3 |
| 150 | 5.380 [136.65] | 4.900 [124.46] | 5-103264-3 | — |
| 210 | 7.380 [187.45] | 6.900 [175.26] | 5-103264-4 | — |

Note: All part numbers are RoHS compliant.

Headers, VRM (Voltage Regulator Module), .100 x .100 [2.54 x 2.54] Centerline

Solder Posts and ACTION PIN Posts (with Pin Protection, Guide Ribs, and Latching)

Material and Finish

Housing — Glass-filled thermoplastic, black, 94V-0 rated

Posts — Copper alloy, duplex plated .000030 [0.00076] gold on contact area, .000100-.000200 [0.00254-0.00508] matte tin on termination end, with entire post underplated .000050 [0.00127] nickel

Related Product Data

Mateable Receptacles — pages 195, 196

Performance Specifications — page 194

ACTION PIN Posts — page 150, 151

Application Tooling — pages 152

Technical Documents — page 276

Product Specification
108-25017

Application Specification
114-9009

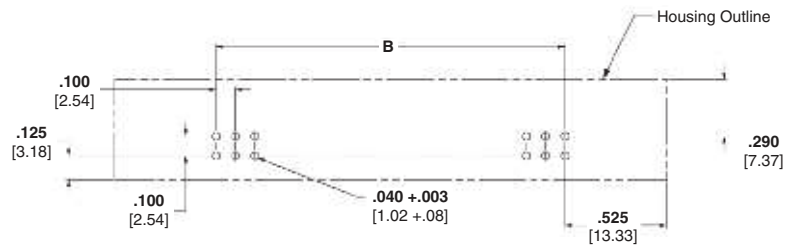
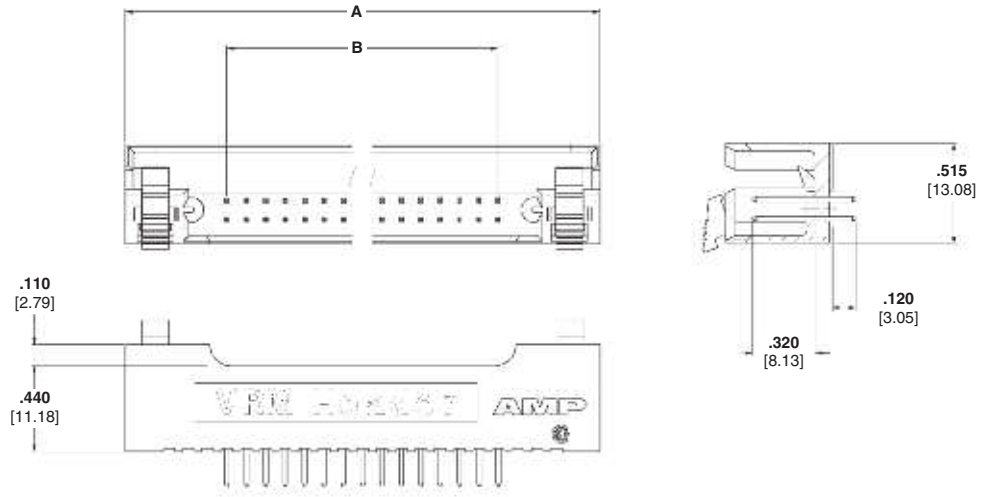

Recommended PC Board Hole Layout

| No of Pos | Dimensions | | Header Part No. | |
|-----------|---------------|---------------|-----------------------|------------------------------|
| | A | B | Standard Solder Tails | .250 Length ACTION PIN Tails |
| 30 | 2.450 [62.23] | 1.400 [35.56] | 5-146205-1 | — |
| 40 | 3.095 [78.62] | 1.900 [48.26] | — | 5-147254-1 |
| | 3.100 [78.74] | 1.900 [48.26] | 5-146315-1 | — |

Note: All part numbers are RoHS compliant.

Accessories: End Shrouds for Machine-Applied Posts

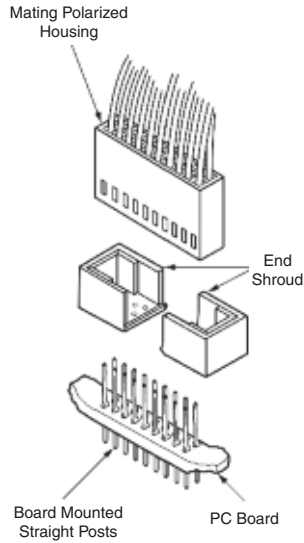

Typical Assembly

Technical Documents — page 276

Single-Row, .100 [2.54] Centers Part No. 102338-1

Material — Black thermoplastic, flame retardant

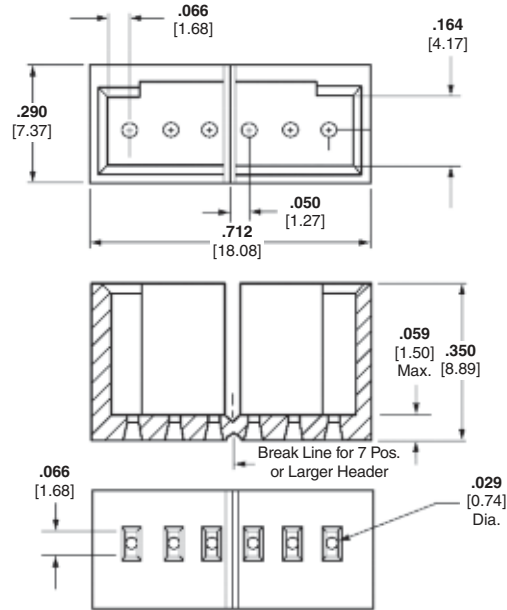

Double-Row, .100 x .100 [2.54 x 2.54] Centers Part No. 102114-1

Material — Black glass-filled polyester

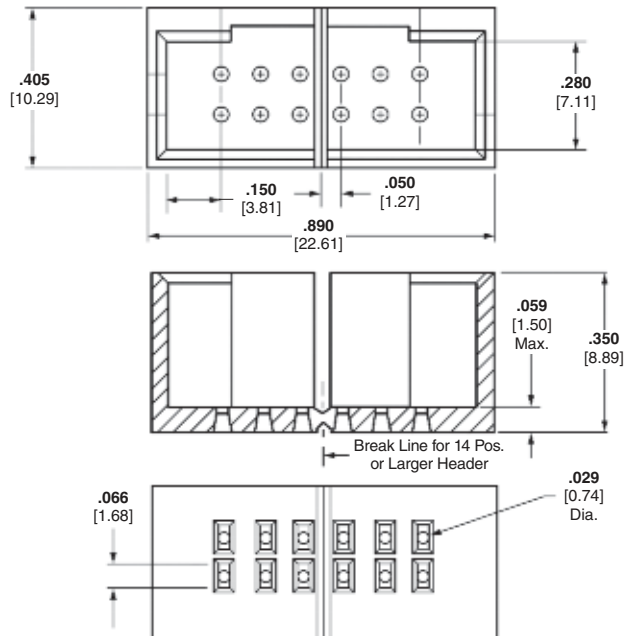

Note: All part numbers are RoHS compliant.

Accessories: Barrier Insert, Part No. 87743-1

Material

Black polyester

Technical Documents — page 276

The barrier insert can be used on double row headers (.100 x .100 [2.54 x 2.54] centers), including shrouded versions—3 and 4 sides, as well as unshrouded straight post headers. With one barrier insert several configurations can be obtained, providing headers with capabilities of accepting various combinations of polarized and non-polarized AMPMODU connectors.

For unshrouded headers, the barrier insert is used to establish polarization and to compartmentalize the header. For shrouded headers, the barrier insert is used to compartmentalize the header, while maintaining polarization. The barrier insert itself is notched to facilitate cutting off the ends with a simple tool such as tin snips or scissors to achieve the desired configuration.

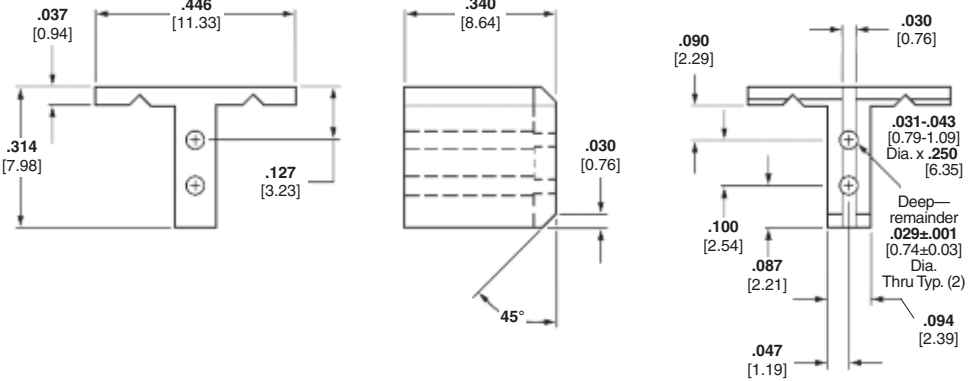

Barrier Insert Cutoffs



Fig. 1
Partial Cutoff
(Left and Right Sides)



Fig. 2
Partial Cutoff
(Left Side)
Complete Cutoff
(Right Side)



Fig. 3
Complete Cutoff
(Left Side)
Partial Cutoff
(Right Side)



Fig. 4
Complete Cutoff
(Left and Right Sides)

Typical Barrier Insert Applications

For Unshrouded Double-Row, Straight Post Headers, .100 x .100 [2.54 x 2.54] Centers

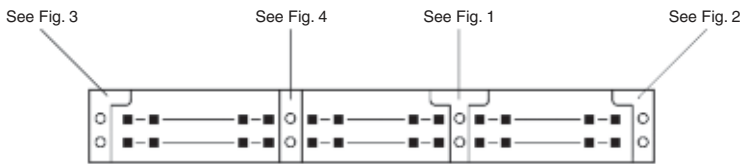

Note: All configurations of barrier inserts compartmentalize headers and maintain polarization, except bar (Fig. 4) configuration, which is used primarily for compartmentalizing headers.

For Shrouded Double-Row, 3 and 4 Sided Headers, .100 x .100 [2.54 x 2.54] Centers

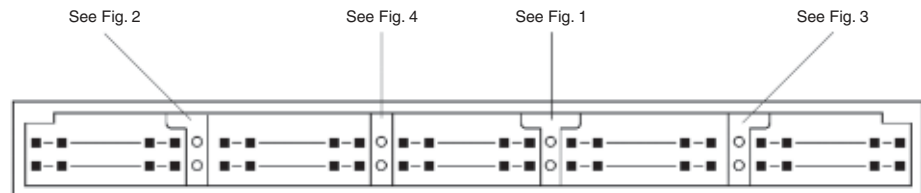

Note: Right-angle (Figs. 2 and 3) and “T” (Fig. 1) configurations of barrier insert establish polarization; bar (Fig. 4) configuration of barrier insert compartmentalizes header.

Note: All part numbers are RoHS compliant.

Accessories: Snap-In Polarizer for Low Profile Headers

Material

Black thermoplastic, flame retardant

Part Numbers

499991-2 (Packaged 50 per bag)

499991-3 (Packaged 1000 per bag)

Related Product Data

Low Profile Headers used with —
pages 135-140

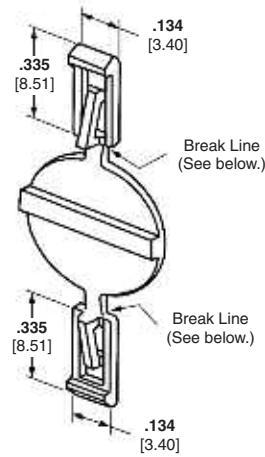

The snap-in polarizer provides military polarization for low profile headers. Installation of the polarizer is as follows:



Orient the polarizer so that the polarizer latch is on the same side as the inner wall (post side) of the header housing.

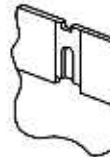

Slide the polarizer over the polarizing slot of the housing until the latch engages the hole. Snap off the tab at the break line next to the housing. Using the remaining polarizer, repeat the process for the other housing location.

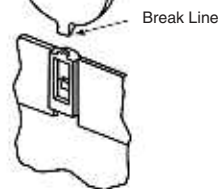



Note: For Post Shunts, contact TE.

Note: All part numbers are RoHS compliant.

Locking Clip Contacts and Housings

Product Facts

- Self-retaining contacts provide permanent connection with quick connect and disconnect
- Fast, easy installation with no additional locking hardware required
- Mates with .025 [0.64] square posts in a variety of configurations
- Single- and double-row configurations in up to 20 positions on .100 [2.54] centers
- Modular design permits end-to-end stacking (double- row only) for circuit grouping
- Choice of tin or select gold plating
- Housings made of 94V-0 rated glass-filled polyester
- Recognized under the Component Program of Underwriters Laboratories Inc., File No. E28476 
- Certified by Canadian Standards Association, File No. LR 7189 

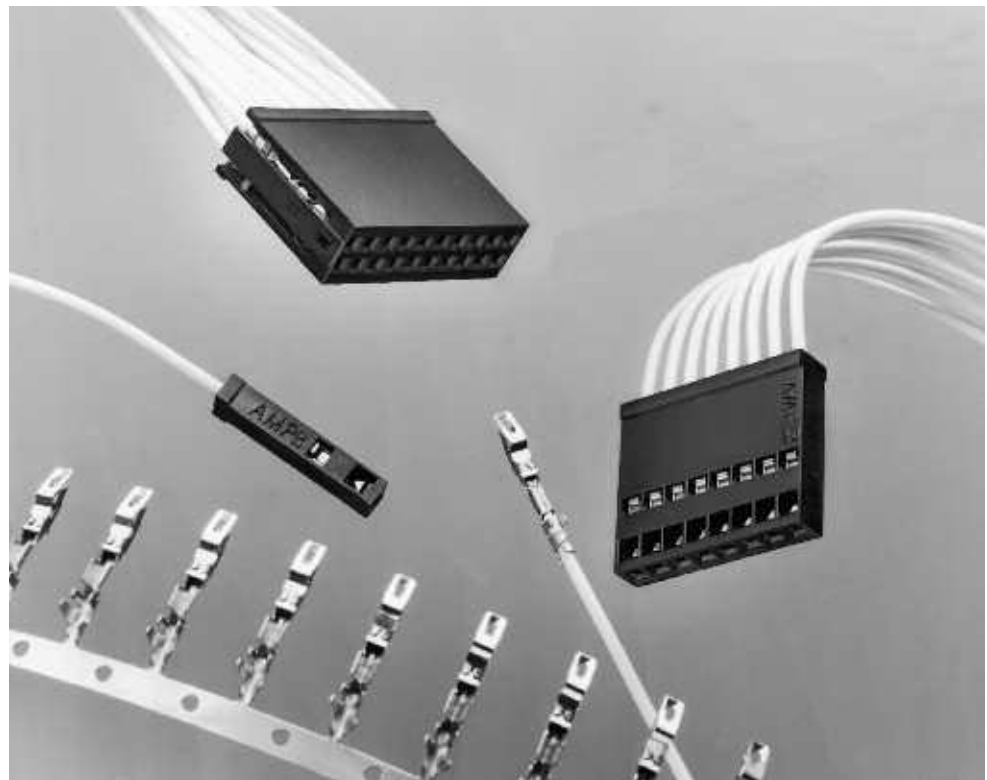

Typical Application

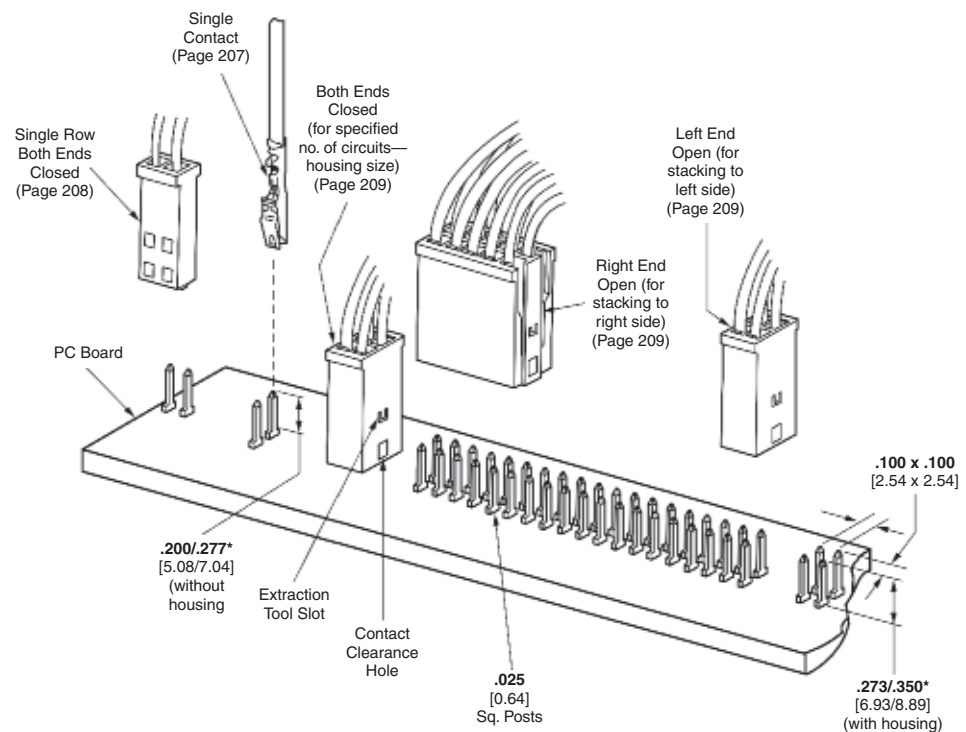

*If post is longer than maximum specified, post tip may butt against wire ends.
Dimension defines .025 x .025 [0.64 x 0.64] portion of post.

Performance Characteristics

Contact Current Rating — 3 amperes

Termination Resistance — 12 milliohms (max.) — Gold plated contacts
16 milliohms (max.) — Tin plated contacts

Durability — Ref. Product Specification 108-36028 and 108-36028-1

Locking Clip Contacts

Wire Crimp Contacts with Insulation Support

Material and Finish

Contact Spring — Stainless steel

Plating A — Selectively plated .000050 [0.00127] gold on contact area, with gold flash over .000050 [0.00127] nickel on entire contact

Plating B — Selectively plated .000030 [0.00076] gold on contact area, with gold flash over .000050 [0.00127] nickel on entire contact

Plating C — .000100-.000200 [0.00254-0.00508] bright tin over .000050 [0.00127] nickel on entire contact

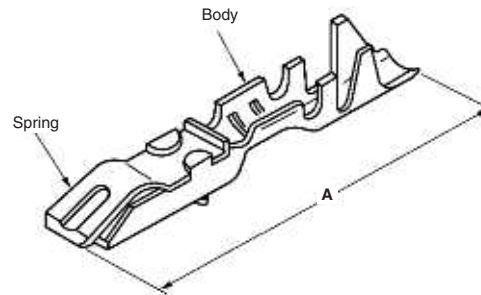

| Wire Size Range | | Ins. Dia. Range | Dimension A | Finish | Part Nos. | | Heavy Duty Miniature Applicator for AMP-O-LECTRIC Machine* | Hand Tool No. |
|-----------------|--------------------|-----------------------|--------------|-----------|------------|-------------|--|---------------|
| AWG | [mm ²] | | | | Strip Form | Loose Piece | | |
| 30-28 | 0.05-0.09 | .029-.039 [0.74-0.99] | .550 [13.97] | Plating B | 87190-1 | 87191-1 | 567310-2 | 90295-1 |
| | | | | Plating C | 5-87190-2 | 5-87191-2 | | |
| 26-22 | 0.12-0.4 | .038-.062 [0.97-1.57] | .584 [14.83] | Plating A | 87124-3 | 87165-3 | 466721-2 | 91533-1 |
| | | | | Plating B | 87124-1 | 87165-1 | | |
| | | | | Plating C | 5-87124-2 | 5-87165-2 | | |
| 20 | 0.5-0.6 | .038-.062 [0.97-1.57] | .584 [14.83] | Plating B | 867052-2 | — | 679996-2 | 90431-1 |
| | | | | Plating C | 5-867052-1 | — | | |

*For use with AMP-O-LECTRIC Model "K" machines. Call the Technical Support Center (1-800-522-6752) for part nos. of applicators for use with the AMP-O-LECTRIC Model "G" machines (shown on page 270), as well as other bench machines and fully automatic AMPOMATOR lead making machines.

- Notes:** 1. These contacts must be crimped in accordance with TE Specification No. 114-25006 in order to function properly in a connector housing.
2. **Extraction Tool No. 91084-1** is used for removing individual contacts from connector housings and for detaching contacts from mating posts.

Related Product Data

Housings Used With — pages 208, 209

Application Tooling — page 272

Technical Documents — pages 277, 278

Product Specification
108-36028, 108-36028-1

Application Specification
114-25006

Wire Harnessing

If necessary, wires can be grouped with cable ties and secured to a panel with fixed clamps. However, locking clip contacts must be free to float within the connector housings to allow proper extraction. Therefore, harnessing hardware or the use of multiple terminations per contact must not restrict the free-floating action of contacts in the housing.

For more information request Insulation and Bundling Products Catalog 124132.

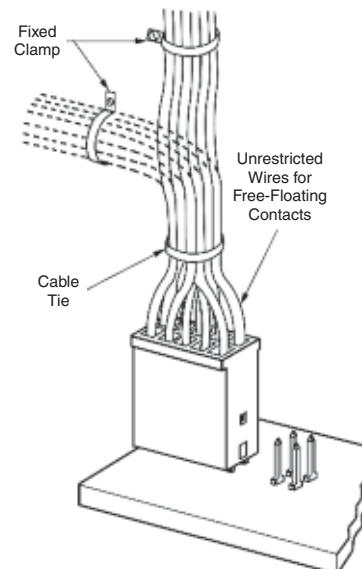

Extraction Tool No. 91084-1

Note: All part numbers are RoHS compliant.

Wire-Applied Housings for Locking Clip Contacts, Single-Row, .100 [2.54] Centerline

Single-Row



Material

Glass-filled polyester, 94V-0 rated

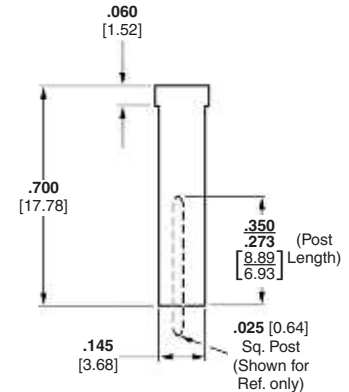
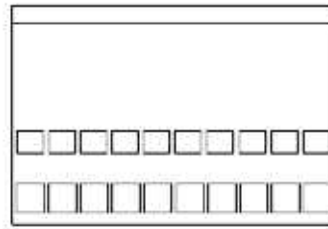

Related Product Data

Contacts — page 207

Mateable Headers and Posts — Refer to the Mating Post Selection Guide — page 90

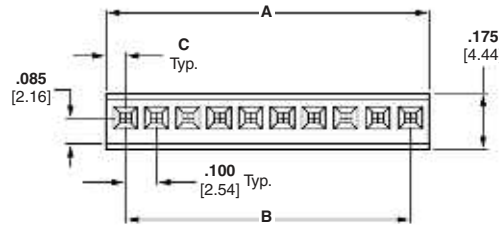

Note: Housing illustrated above is the "Both Ends Closed" version.

Technical Documents — pages 277, 278

Product Specification
108-36028, 108-36028-1

Application Specification
114-25006

.125 [3.18] centerline single-row, 2 and 3 position housings are available, Base Part No. 104905. They are designed to be stackable end-to-end and side-by-side. Consult TE.

Keying Plug



Part No. 87179-1

(Plugs directly into housings for .025 [0.64] square post contacts)

Material — Yellow, nylon

Note: All part numbers are RoHS compliant.

| No. of Pos. | Dimensions | | | Housing Part No. | |
|-------------|---------------|---------------|-------------|------------------|-----------|
| | A | B | C | Unstamped | Stamped |
| 1 | .108 [2.74] | — | .054 [1.37] | 87175-2 | — |
| 2 | .216 [5.49] | .100 [2.54] | .058 [1.47] | 87175-6 | — |
| 3 | .316 [8.03] | .200 [5.08] | .058 [1.47] | 87175-8 | — |
| 4 | .416 [10.57] | .300 [7.62] | .058 [1.47] | 1-87175-0 | — |
| 5 | .516 [13.11] | .400 [10.16] | .058 [1.47] | 1-87175-2 | — |
| 6 | .616 [15.65] | .500 [12.70] | .058 [1.47] | 1-87175-4 | 1-87175-3 |
| 7 | .716 [18.19] | .600 [15.24] | .058 [1.47] | 1-87175-6 | 1-87175-5 |
| 8 | .816 [20.73] | .700 [17.78] | .058 [1.47] | 1-87175-8 | 1-87175-7 |
| 9 | .916 [23.27] | .800 [20.32] | .058 [1.47] | 2-87175-0 | 1-87175-9 |
| 10 | 1.016 [25.81] | .900 [22.86] | .058 [1.47] | 2-87175-2 | 2-87175-1 |
| 11 | 1.116 [28.35] | 1.000 [25.40] | .058 [1.47] | 2-87175-4 | 2-87175-3 |
| 12 | 1.216 [30.89] | 1.100 [27.94] | .058 [1.47] | 2-87175-6 | 2-87175-5 |
| 13 | 1.316 [33.43] | 1.200 [30.48] | .058 [1.47] | 2-87175-8 | 2-87175-7 |
| 14 | 1.416 [35.97] | 1.300 [33.02] | .058 [1.47] | 3-87175-0 | 2-87175-9 |
| 15 | 1.516 [38.51] | 1.400 [35.56] | .058 [1.47] | 87175-4 | 87175-3 |

Wire-Applied Housings for Locking Clip Contacts, Double-Row, .100 x .100 [2.54 x 2.54] Centerline

Double-Row



Material

Glass-filled polyester, 94V-0 rated

Related Product Data

Contacts — page 207

Mateable Headers and Posts — Refer to the Mating Post Selection Guide — page 90

Technical Documents — pages 277, 278

Product Specification
108-36028, 108-36028-1

Application Specification
114-25006

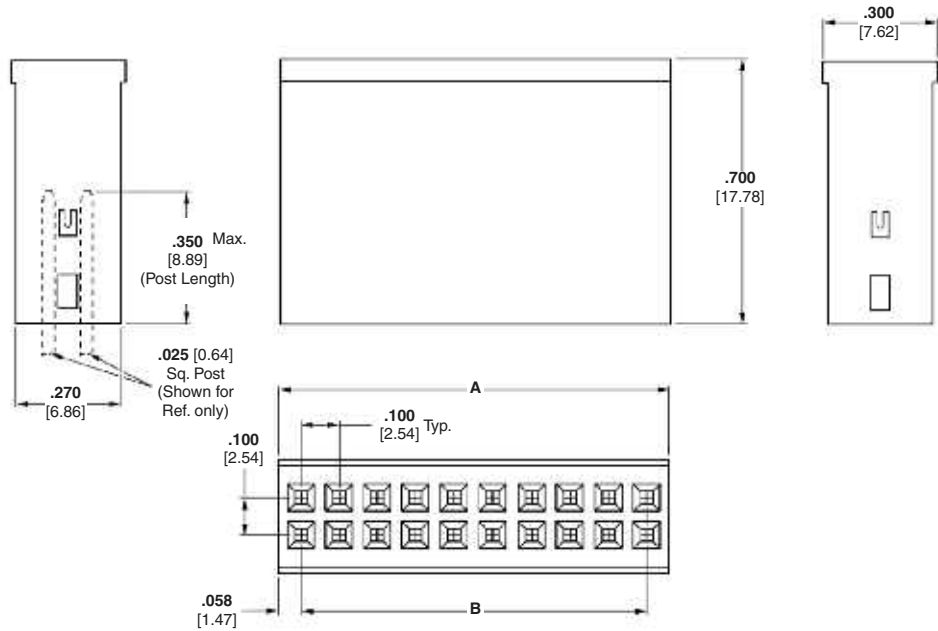

Note: Housing illustrated above is the "Both Ends Closed" version.

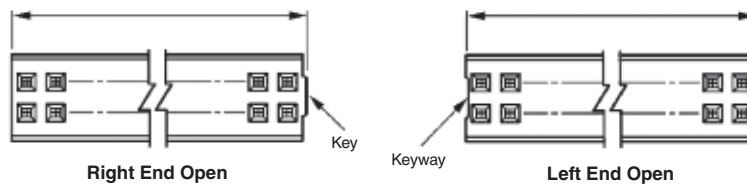
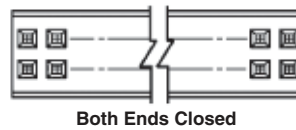

Keying Plug



Part No. 87179-1

(Plugs directly into housings for .025 [0.64] square post contacts)

Material — Yellow, nylon

Note: All part numbers are RoHS compliant.

| Housing Configuration | No. of Pos. | Dimensions | | Housing Part No. | |
|-----------------------|-------------|---------------|--------------|------------------|-----------|
| | | A | B | Unstamped | Stamped |
| Both Ends Closed | 2 | .116 [2.95] | — | 87176-2 | — |
| | 4 | .216 [5.49] | .100 [2.54] | 87133-1 | — |
| | 6 | .316 [8.03] | .200 [5.08] | 87133-7 | 87133-8 |
| | 8 | .416 [10.57] | .300 [7.62] | 87133-9 | 1-87133-0 |
| | 10 | .516 [13.11] | .400 [10.16] | 87133-2 | 87133-5 |
| | 12 | .616 [15.65] | .500 [12.70] | 1-87133-1 | 1-87133-2 |
| | 16 | .816 [20.73] | .700 [17.78] | 1-87133-3 | 1-87133-4 |
| | 18 | .916 [23.27] | .800 [20.32] | 1-87133-5 | 1-87133-6 |
| Right End Open | 20 | 1.016 [25.81] | .900 [22.86] | 87133-3 | 87133-6 |
| | 4 | .216 [5.49] | .100 [2.54] | 87132-1 | — |
| | 10 | .516 [13.11] | .400 [10.16] | 87132-2 | 87132-5 |
| Left End Open | 20 | 1.016 [25.81] | .900 [22.86] | 87132-3 | 87132-6 |
| | 4 | .216 [5.49] | .100 [2.54] | 87131-1 | — |
| | 10 | .516 [13.11] | .400 [10.16] | 87131-2 | 87131-5 |
| | 20 | 1.016 [25.81] | .900 [22.86] | 87131-3 | 87131-6 |

Mod IV Wire-Applied Contacts and Housings

Product Facts

- Terminates 32-20 AWG [0.03-0.6mm²] discrete wire
- Contacts have insulation support
- Choice of three contact mating pressures
- Available in a variety of gold and tin platings
- Receptacles mate with .025 [0.64] square or round posts
- Dual cantilever contact beam with built-in anti-overstress feature for reliable matings
- Housings accept a variety of receptacle and pin contacts
- Housing sizes range up to 100 positions
- Housing configurations include single- and double-rows on .100 [2.54] centerlines
- Housing options include detent latching, polarization and bonded strain relief/pull tabs
- Recognized under the Component Program of Underwriters Laboratories Inc., File No. E28476
- Certified by Canadian Standards Association, File No. LR 7189

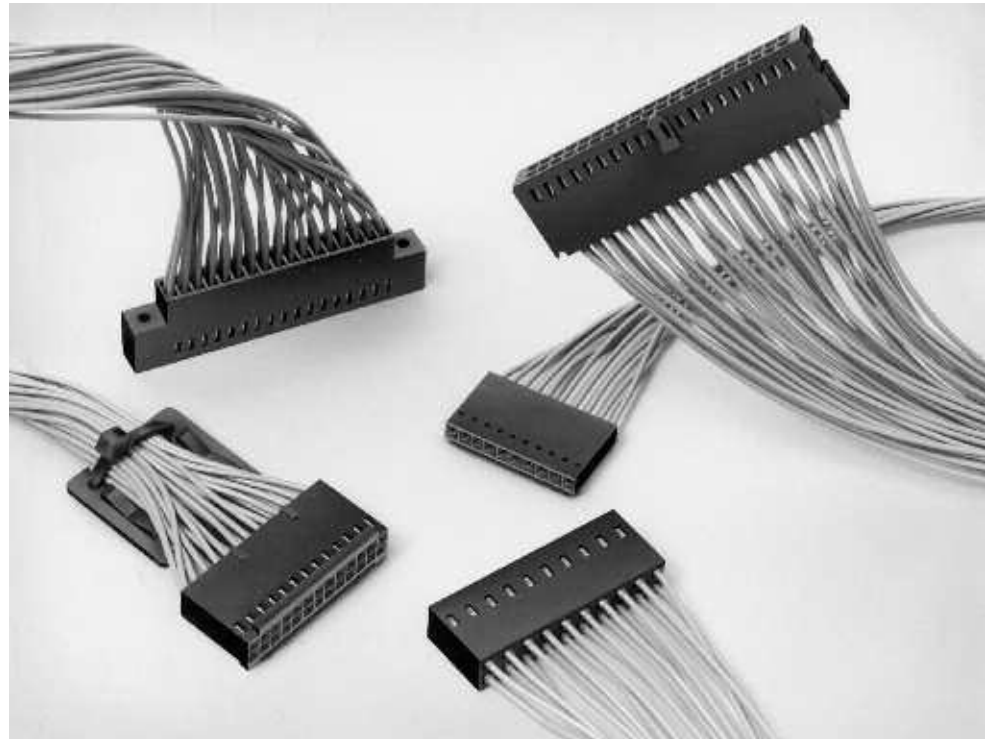

Mod IV Wire-Applied Contacts and Housings

5

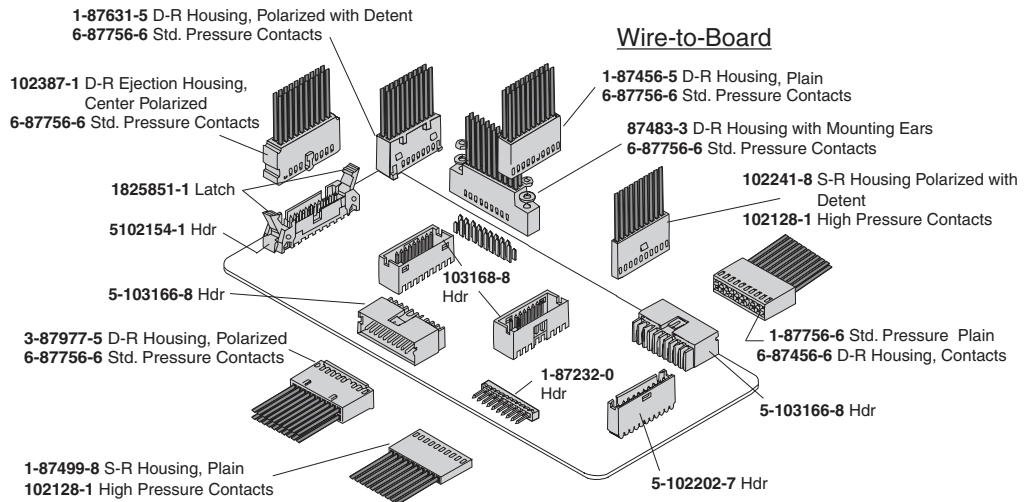

Performance Characteristics

Contact Current Rating — 3 amperes

Termination Resistance — 12 milliohms (max.) — Beryllium copper contacts
20 milliohms (max.) — Copper-tin-phosphor bronze contacts

Durability — Ref. Product Specification 108-25020

Note: All part numbers are RoHS compliant.

Mod IV Pin and Receptacle Contacts

Crimp Snap-In (No-strip) Receptacles and Crimp Snap-In Pins with Insulation Support (Standard Pressure)

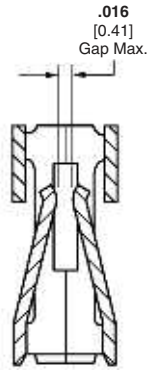

Standard Pressure Configuration

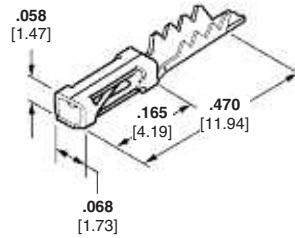

No-Strip Receptacle

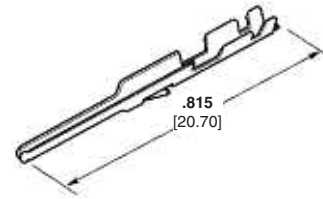

Pin with Insulation Support

Crimp Snap-In (No-strip) Receptacles

| Ins. Dia. Range | Finish | Part Nos. | | Heavy Duty Miniature Applicator No. for AMP-O-LECTRIC Machine* | Hand Tool Part No. |
|-----------------------|-----------|------------|-------------|--|--------------------|
| | | Strip Form | Loose Piece | | |
| .040-.055 [1.02-1.40] | Plating A | 87107-5 | 102348-2 | 567307-2 | 90381-1 |
| | Plating C | 87107-6 | 102348-3 | | |

Material and Finish

Beryllium copper, phosphor bronze, or copper-tin-phosphor bronze (see charts), plated as follows:

Plating A — Selectively plated .000030 [0.00076] gold on contact area, with gold flash over .000050 [0.00127] nickel on entire contact

Plating B — Selectively plated .000015 [0.00038] gold on contact area, with gold flash over .000050 [0.00127] nickel on entire contact

Plating C — .000100-.000200 [0.00254-0.00508] tin over .000030 [0.00076] nickel on entire contact

Related Product Data

Housings Used With — pages 214-220

Performance Characteristics — page 210

Application Tooling — page 270-272

Technical Documents — pages 276-278

Product Specification
108-25007, 108-25019, 108-25020, 108-25021

Application Specification
114-25003, 114-25016

Additional header sizes are available; minimum order quantities may apply. Consult TE.

Crimp Snap-In Pins with Insulation Support

| Wire Size Range | Ins. Dia. (Max.) | Finish | Part Nos. | | Heavy Duty Miniature Applicator No. for AMP-O-LECTRIC Machine* | Hand Tool Part No. | |
|-------------------|------------------|-----------|------------|-------------|--|--------------------|------------|
| | | | Strip Form | Loose Piece | | Premium | Commercial |
| 26-22 0.12-0.4 | .061 [1.55] | Plating A | 102095-3 | 102107-2 | 466812-2 | 91517-1 | 58641-1† |
| | | Plating B | 102095-2 | 102107-1 | | | |
| | | Plating C | 5-102095-4 | 5-102107-3 | | | |

*For use with AMP-O-LECTRIC Model "K" machines. Call the Technical Support Center (1-800-522-6752) for part nos. of applicators for use with the AMP-O-LECTRIC Model "G" machines (shown on page 270), as well as other bench machines and fully automatic AMPOMATOR lead making machines.

†PRO-CRIMPER II hand tool frame with die set assembly. Die Set Part No. 58641-2

Note: All part numbers are RoHS compliant.

Mod IV Receptacle Contacts

Crimp Snap-In Receptacles with Insulation Support (Standard, Intermediate and High Pressure)

Material and Finish

Beryllium copper, phosphor bronze or copper-tin-phosphor bronze (see charts, on following page), plated as follows:

Plating A — Duplex plated .000030 [0.00076] gold on contact area, .000100-.000200 [0.00254-0.00508] tin on crimp area, with entire contact underplated .000050 [0.00127] nickel

Plating B — Duplex plated .000015 [0.00038] gold on contact area, .000100-.000200 [0.00254-0.00508] tin on crimp area, with entire contact underplated .000050 [0.00127] nickel

Plating D — Selectively plated .000050 [0.00127] gold on contact area, with gold flash over .000050 [0.00127] nickel on entire contact

Plating E — Selectively plated .000030 [0.00076] gold on contact area, with gold flash over .000050 [0.00127] nickel on entire contact

Plating F — Selectively plated .000015 [0.00038] gold on contact area, with gold flash over .000050 [0.00127] nickel on entire contact

Plating G — .000100-.000200 [0.00254-0.00508] tin over .000030 [0.00076] nickel on entire contact

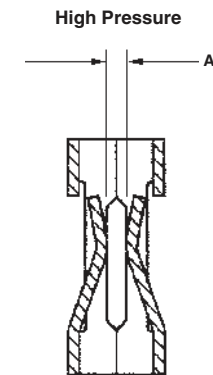
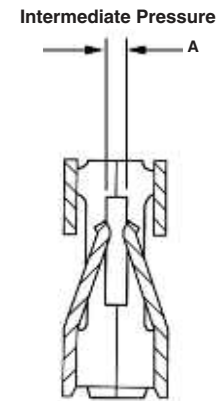
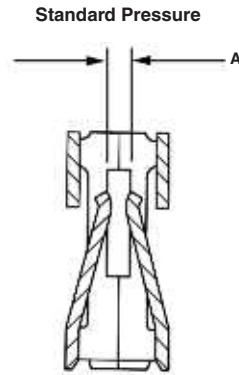
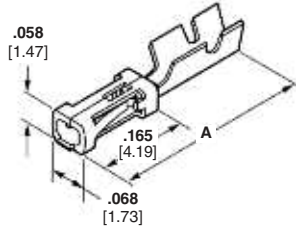

Related Product Data

Housings Used With — pages 214-220

Performance Characteristics — page 210

Application Tooling — pages 270-272

Technical Documents — pages 277, 278

Product Specification
108-25007, 108-25019, 108-25020, 108-25021

Application Specification
114-25003, 114-25016

| | Mating Force | Unmating Force | A-Gap Dimension |
|-----------------------|--------------|----------------|-----------------|
| Standard Pressure | 9 oz. Max. | 1.5 oz. Min. | .008/.014 |
| Intermediate Pressure | 16 oz. Max. | 2 oz. Min. | .008/.014 |
| High Pressure | 20 oz. Max. | 3 oz. Min. | .013±.002 |

Mod IV Receptacle Contacts (Continued)

Standard Pressure (Mod IV)

| Wire Size Range AWG [mm ²] | Ins. Dia. (Max.) | Dimension A | Material | Finish | Part Nos. | | Heavy Duty Miniature Applicator for AMP-O-LECTRIC Machine* | Applicator for Stripper/Crimper Machine | Hand Tool Part Nos. | |
|---|------------------|--------------|-------------|-----------|------------|-------------|--|---|---------------------|------------|
| | | | | | Strip Form | Loose Piece | | | Premium | Commercial |
| 32-27 0.03-0.1 | .040 [1.02] | .445 [11.30] | Cu-Sn-Ph Bz | Plating A | 5-102316-8 | 6-102316-4 | 466655-2 | 466921-1 | 91541-1 | — |
| | | | Cu-Sn-Ph Bz | Plating B | 5-102316-6 | 6-102316-3 | | | | |
| | | | Be Cu | Plating D | 1-102917-1 | 1-102917-2 | | | | |
| | | | Be Cu | Plating E | 102917-1 | 102917-2 | | | | |
| | | | Be Cu | Plating F | 102917-5 | 102917-6 | | | | |
| 26-22 0.12-0.4 | .061 [1.55] | .445 [11.30] | Cu-Sn-Ph Bz | Plating G | 102316-5 | 1-102316-2 | 466571-2 | 466918-1 | 91517-1 | 58641-1† |
| | | | Cu-Sn-Ph Bz | Plating A | 6-87756-7 | 6-87756-8 | | | | |
| | | | Cu-Sn-Ph Bz | Plating B | 6-87756-2 | 6-87756-6 | | | | |
| | | | Cu-Sn-Ph Br | Plating G | 87756-6 | 87756-7 | | | | |
| | | | Be Cu | Plating D | 1-87666-6 | 87667-5 | | | | |
| | | | Be Cu | Plating E | 87666-2 | 87667-2 | | | | |
| | | | Be Cu | Plating F | 87666-5 | 87667-5 | | | | |
| 24-20 0.2-0.6 | .069 [1.75] | .470 [11.94] | Cu-Sn-Ph Bz | Plating G | 87666-3 | 87667-3 | 466562-2 | 466905-1 | 91516-1 | — |
| | | | Cu-Sn-Ph Bz | Plating A | 6-87523-8 | 6-87523-9 | | | | |
| | | | Cu-Sn-Ph Bz | Plating B | 2-87523-3 | 2-87523-4 | | | | |
| | | | Be Cu | Plating E | 85969-8 | 86016-2 | | | | |
| | | | Be Cu | Plating F | 85969-6 | 86016-5 | | | | |
| | | | Cu-Sn-Ph Br | Plating G | 87523-5 | 87523-6 | | | | |
| | | | Be Cu | Plating G | 85969-9 | 86016-3 | | | | |

Intermediate Pressure (Mod IV.v)

| Wire Size Range AWG [mm ²] | Ins. Dia. (Max.) | Dimension A | Material | Finish | Part Nos. | | Heavy Duty Miniature Applicator for AMP-O-LECTRIC Machine* | Applicator for Stripper/Crimper Machine | Hand Tool Part Nos. | |
|---|------------------|--------------|-------------|-----------|------------|-------------|--|---|---------------------|------------|
| | | | | | Strip Form | Loose Piece | | | Premium | Commercial |
| 32-27 0.03-0.1 | .040 [1.02] | .445 [11.30] | Cu-Sn-Ph Bz | Plating A | 5-102920-1 | 5-102920-2 | 466655-2 | 466921-1 | 91541-1 | — |
| | | | Be Cu | Plating E | 102918-1 | 102918-2 | | | | |
| 26-22 0.12-0.4 | .061 [1.55] | .445 [11.30] | Cu-Sn-Ph Bz | Plating A | 5-103171-4 | 5-103171-5 | 466571-2 | 466918-1 | 91517-1 | 58641-1† |
| | | | Cu-Sn-Ph Bz | Plating B | 5-103171-1 | 5-103171-2 | | | | |
| | | | Be Cu | Plating E | 102548-5 | 102548-6 | | | | |
| 24-20 0.2-0.6 | .069 [1.75] | .470 [11.94] | Be Cu | Plating F | 102548-1 | 102548-3 | 466562-2 | 466905-1 | 91516-1 | — |
| | | | Cu-Sn-Ph Bz | Plating A | 2-87195-3 | 2-87195-6 | | | | |
| | | | Cu-Sn-Ph Bz | Plating B | 2-87195-4 | 2-87195-5 | | | | |
| | | | Be Cu | Plating E | 86492-6 | 87046-3 | | | | |
| | | | Be Cu | Plating F | 86492-2 | 87046-1 | | | | |
| | | | Be Cu | Plating G | 86492-9 | 87046-4 | | | | |

High Pressure (Mod V)**

| Wire Size Range AWG [mm ²] | Ins. Dia. (Max.) | Dimension A | Material | Finish | Part Nos. | | Heavy Duty Miniature Applicator for AMP-O-LECTRIC Machine* | Applicator for AMP-O-MATIC Stripper/Crimper Machine | Hand Tool Part Nos. |
|---|------------------|--------------|----------|-----------|------------|-------------|--|---|---------------------|
| | | | | | Strip Form | Loose Piece | | | |
| 32-27 0.03-0.1 | .040 [1.02] | .445 [11.30] | Ph Bz | Plating E | 103455-1 | 103455-2 | 466655-2 | 466921-1 | 91541-1 |
| 26-22 0.12-0.4 | .061 [1.55] | .445 [11.30] | Ph Bz | Plating E | 87809-1 | 102128-1 | 466571-2 | 466918-1 | 91517-1 |
| | | | Ph Bz | Plating G | 87809-2 | 102128-2 | | | |
| 24-20 0.2-0.6 | .069 [1.75] | .470 [11.94] | Ph Bz | Plating E | 87309-9 | 1-87309-4 | 466562-2 | 466905-1 | 91516-1 |
| | | | Ph Bz | Plating G | 87309-8 | 1-87309-3 | | | |

*For use with AMP-O-LECTRIC Model "K" machines. Call the Technical Support Center (1-800-522-6752) for part nos. of applicators for use with the AMP-O-LECTRIC Model "G" machines (shown on page 270), as well as other bench machines and fully automatic AMPOMATOR lead making machines.

**Contact material is phosphor bronze.

†PRO-CRIMPER II hand tool frame with die set assembly.
Die Set Part No. 58641-2

Note: All part numbers are RoHS compliant.

Mod IV Wire-Applied Housings, Single-Row, .100 [2.54] Centerline

Non-Polarized



Material

Black thermoplastic, flame retardant

Related Product Data

Contacts — pages 211-213

Mateable Headers and Posts — pages 93-95, 101-103

Technical Documents —

pages 277, 278

Product Specification

108-25007, 108-25019, 108-25020, 108-25021

Application Specification

114-25003, 114-25016

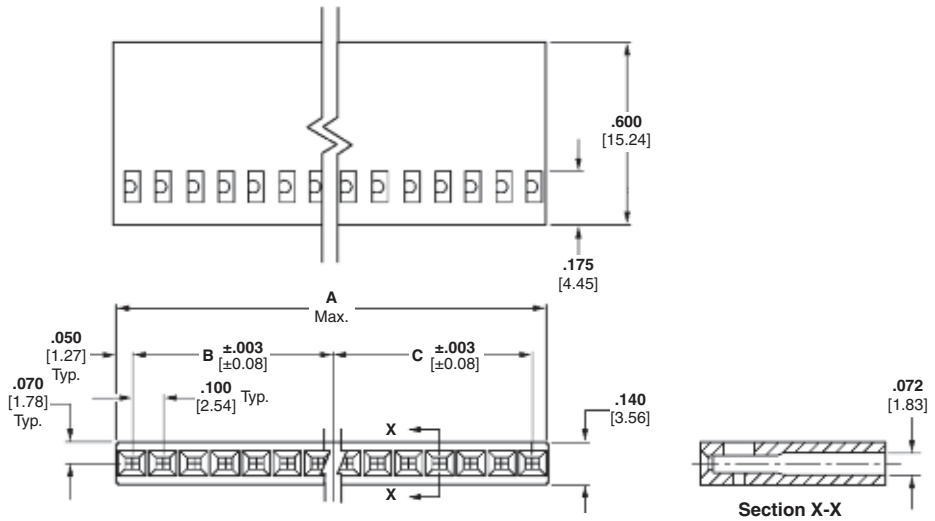

Keying Plugs

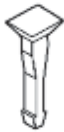

Part No. 86286-1

(Plugs into standard or intermediate pressure receptacle contact)

Material — Natural color nylon

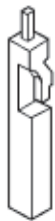

Part No. 87077-2

(Plugs directly into housing)

| No. of Pos. | Dimensions | | | Part No. | |
|-------------|---------------|---------------|---------------|-----------|-------------|
| | A | B | C | Stamped* | Unstamped** |
| 1 | .105 [2.67] | — | — | — | 7-87499-2 |
| 2 | .205 [5.21] | .100 [2.54] | — | 87499-3 | 87499-4 |
| 3 | .305 [7.75] | .100 [2.54] | .100 [2.54] | 87499-5 | 87499-6 |
| 4 | .405 [10.29] | .200 [5.08] | .100 [2.54] | 87499-7 | 87499-8 |
| 5 | .505 [12.83] | .200 [5.08] | .200 [5.08] | 87499-9 | 1-87499-0 |
| 6 | .605 [15.37] | .300 [7.62] | .200 [5.08] | 1-87499-1 | 1-87499-2 |
| 7 | .705 [17.91] | .300 [7.62] | .300 [7.62] | 87499-1 | 87499-2 |
| 8 | .805 [20.45] | .400 [10.16] | .300 [7.62] | 1-87499-3 | 1-87499-4 |
| 9 | .905 [22.99] | .400 [10.16] | .400 [10.16] | 1-87499-5 | 1-87499-6 |
| 10 | 1.005 [25.53] | .500 [12.70] | .400 [10.16] | 1-87499-7 | 1-87499-8 |
| 11 | 1.105 [28.01] | .500 [12.70] | .500 [12.70] | 1-87499-9 | 2-87499-0 |
| 12 | 1.205 [30.61] | .600 [15.24] | .500 [12.70] | 2-87499-1 | 2-87499-2 |
| 13 | 1.305 [33.15] | .600 [15.24] | .600 [15.24] | 2-87499-3 | 2-87499-4 |
| 14 | 1.405 [35.69] | .700 [17.78] | .600 [15.24] | 2-87499-5 | 2-87499-6 |
| 15 | 1.505 [38.23] | .700 [17.78] | .700 [17.78] | 2-87499-7 | 2-87499-8 |
| 16 | 1.605 [40.77] | .800 [20.32] | .700 [17.78] | 2-87499-9 | 3-87499-0 |
| 17 | 1.700 [43.18] | .800 [20.32] | .800 [20.32] | — | 3-87499-2 |
| 18 | 1.805 [45.85] | .900 [22.86] | .800 [20.32] | — | 3-87499-4 |
| 19 | 1.900 [48.26] | .900 [22.86] | .900 [22.86] | — | 3-87499-6 |
| 20 | 2.005 [50.93] | 1.000 [25.40] | .900 [22.86] | 3-87499-7 | 3-87499-8 |
| 21 | 2.100 [53.34] | 1.000 [25.40] | 1.000 [25.40] | — | 4-87499-0 |
| 22 | 2.205 [56.01] | 1.100 [27.94] | 1.000 [25.40] | — | 4-87499-2 |
| 23 | 2.300 [58.42] | 1.100 [27.94] | 1.100 [27.94] | — | 4-87499-4 |
| 24 | 2.400 [60.96] | 1.200 [30.48] | 1.100 [27.94] | — | 4-87499-6 |
| 25 | 2.500 [63.50] | 1.200 [30.48] | 1.200 [30.48] | — | 4-87499-8 |
| 26 | 2.605 [66.17] | 1.300 [33.02] | 1.200 [30.48] | — | 5-87499-0 |
| 27 | 2.700 [68.58] | 1.300 [33.02] | 1.300 [33.02] | — | 5-87499-2 |
| 28 | 2.800 [71.12] | 1.400 [35.56] | 1.300 [33.02] | — | 5-87499-4 |
| 29 | 2.900 [73.66] | 1.400 [35.56] | 1.400 [35.56] | — | 5-87499-6 |
| 30 | 3.005 [76.33] | 1.500 [38.10] | 1.400 [35.56] | — | 5-87499-8 |
| 31 | 3.100 [78.74] | 1.500 [38.10] | 1.500 [38.10] | — | 6-87499-0 |
| 32 | 3.200 [81.28] | 1.600 [40.64] | 1.500 [38.10] | — | 6-87499-2 |
| 33 | 3.300 [83.82] | 1.600 [40.64] | 1.600 [40.64] | — | 6-87499-4 |
| 34 | 3.400 [86.36] | 1.700 [43.18] | 1.600 [40.64] | — | 6-87499-6 |
| 35 | 3.500 [88.98] | 1.700 [43.18] | 1.700 [43.18] | — | 6-87499-8 |
| 36 | 3.600 [91.44] | 1.800 [45.72] | 1.700 [43.18] | — | 7-87499-0 |

*Cavity identification, part number and date code stamped on housing where size permits.

**No marking on housing.

Notes: 1. Strain reliefs are available and may be purchased separately. Consult TE.
2. Contact **Extraction/Lance Reset Tool No. 843996-3**.

Note: All part numbers are RoHS compliant.

Mod IV Wire-Applied Housings, Single-Row, .100 [2.54] Centerline (Continued)

Polarized (with Detent Latching)

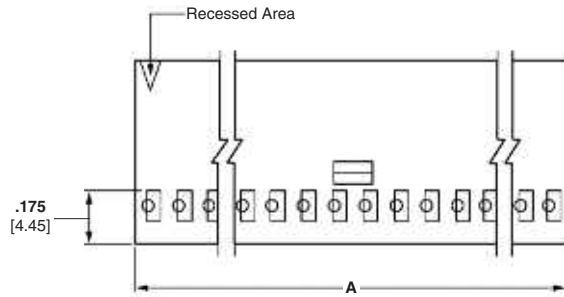

Material

Black thermoplastic, flame retardant

Related Product Data

- Contacts** — pages 211-213
- Mateable Headers and Posts** — pages 115, 116
- Flexible Film Connectors, Single-Row Pin Assemblies** — Catalog 82007

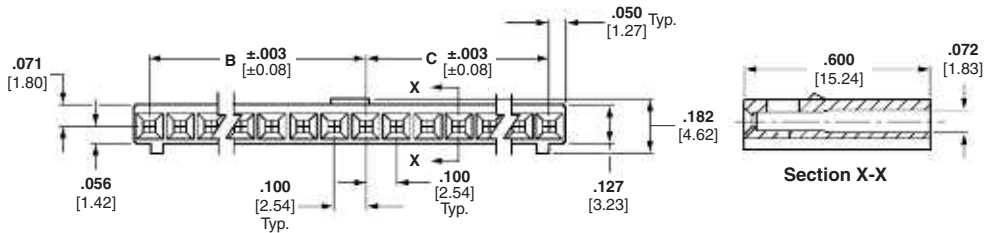

Technical Documents — pages 277, 278

Product Specification
108-25007, 108-25019, 108-25020, 108-25021

Application Specification
114-25003, 114-25016

| No. of Pos. | Dimensions | | | Part Nos. Unstamped* |
|-------------|---------------|---------------|---------------|----------------------|
| | A | B | C | |
| 3 | .300 [7.62] | .100 [2.54] | .100 [2.54] | 102241-1 |
| 4 | .400 [10.16] | .200 [5.08] | .100 [2.54] | 102241-2 |
| 5 | .500 [12.70] | .200 [5.08] | .200 [5.08] | 102241-3 |
| 6 | .600 [15.24] | .300 [7.62] | .200 [5.08] | 102241-4 |
| 7 | .700 [17.78] | .300 [7.62] | .300 [7.62] | 102241-5 |
| 8 | .800 [20.32] | .400 [10.16] | .300 [7.62] | 102241-6 |
| 9 | .900 [22.86] | .400 [10.16] | .400 [10.16] | 102241-7 |
| 10 | 1.000 [25.40] | .500 [12.70] | .400 [10.16] | 102241-8 |
| 11 | 1.100 [27.94] | .500 [12.70] | .500 [12.70] | 102241-9 |
| 12 | 1.200 [30.48] | .600 [15.24] | .500 [12.70] | 1-102241-0 |
| 13 | 1.300 [33.02] | .600 [15.24] | .600 [15.24] | 1-102241-1 |
| 14 | 1.400 [35.56] | .700 [17.78] | .600 [15.24] | 1-102241-2 |
| 15 | 1.500 [38.10] | .700 [17.78] | .700 [17.78] | 1-102241-3 |
| 16 | 1.600 [40.64] | .800 [20.32] | .700 [17.78] | 1-102241-4 |
| 17 | 1.700 [43.18] | .800 [20.32] | .800 [20.32] | 1-102241-5 |
| 18 | 1.800 [45.72] | .900 [22.86] | .800 [20.32] | 1-102241-6 |
| 19 | 1.900 [48.26] | .900 [22.86] | .900 [22.86] | 1-102241-7 |
| 20 | 2.000 [50.80] | 1.000 [25.40] | .900 [22.86] | 1-102241-8 |
| 21 | 2.100 [53.34] | 1.000 [25.40] | 1.000 [25.40] | 1-102241-9 |
| 22 | 2.200 [55.88] | 1.100 [27.94] | 1.000 [25.40] | 2-102241-0 |
| 23 | 2.300 [58.42] | 1.100 [27.94] | 1.100 [27.94] | 2-102241-1 |
| 24 | 2.400 [60.96] | 1.200 [30.48] | 1.100 [27.94] | 2-102241-2 |
| 25 | 2.500 [63.50] | 1.200 [30.48] | 1.200 [30.48] | 2-102241-3 |
| 26 | 2.600 [66.04] | 1.300 [33.02] | 1.200 [30.48] | 2-102241-4 |
| 27 | 2.700 [68.58] | 1.300 [33.02] | 1.300 [33.02] | 2-102241-5 |
| 28 | 2.800 [71.12] | 1.400 [35.56] | 1.300 [33.02] | 2-102241-6 |
| 29 | 2.900 [73.66] | 1.400 [35.56] | 1.400 [35.56] | 2-102241-7 |
| 30 | 3.000 [76.20] | 1.500 [38.10] | 1.400 [35.56] | 2-102241-8 |
| 31 | 3.100 [78.74] | 1.500 [38.10] | 1.500 [38.10] | 2-102241-9 |
| 32 | 3.200 [81.28] | 1.600 [40.64] | 1.500 [38.10] | 3-102241-0 |
| 33 | 3.300 [83.82] | 1.600 [40.64] | 1.600 [40.64] | 3-102241-1 |
| 34 | 3.400 [86.36] | 1.700 [43.18] | 1.600 [40.64] | 3-102242-2 |
| 35 | 3.500 [88.90] | 1.700 [43.18] | 1.700 [43.18] | 3-102241-3 |
| 36 | 3.600 [91.44] | 1.800 [45.72] | 1.700 [43.18] | 3-102241-4 |

*No marking on housing.
Note: Contact Extraction/Lance Reset Tool No. 843996-3.

Note: All part numbers are RoHS compliant.

Keying Plugs



Part No. 86286-1
(Plugs into standard or intermediate pressure receptacle contact)

Material — Natural color nylon

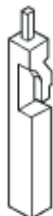

Part No. 87077-2
(Plugs directly into housing)

Mod IV Wire-Applied Housings, Double-Row, .100 x .100 [2.54 x 2.54] Centerline

Non-Polarized

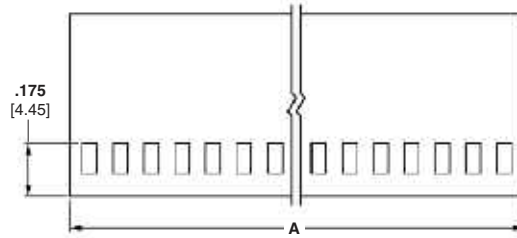

Material

Black thermoplastic, flame retardant

Related Product Data

Contacts — pages 211-213
Mateable Headers and Posts — pages 96-99, 104, 105, 117-120

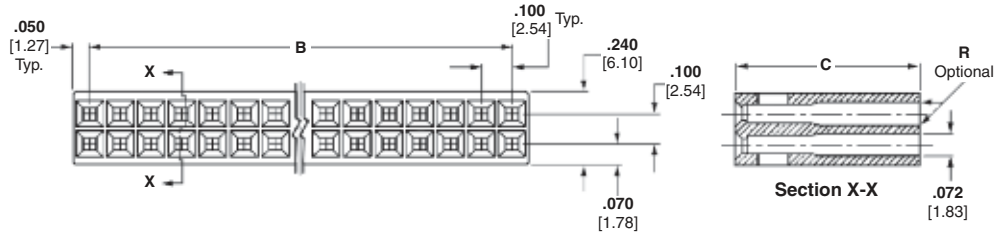

Technical Documents —

pages 277, 278

Product Specification
 108-25007, 108-25019, 108-25020, 108-25021

Application Specification
 114-25003, 114-25016

Keying Plugs

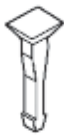

Part No. 86286-1
 (Plugs into standard or intermediate pressure receptacle contact)

Material — Natural color nylon

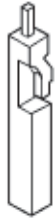

Part No. 87077-1
 (for .645 high housings)
Part No. 87077-2
 (for .600 high housings)
 (Plugs directly into housing)

| No. of Pos. | Dimensions | | Part Nos. | | |
|-------------|---------------|---------------|------------------|-------------|------------------|
| | A | B | C = .600 [15.24] | | C = .645 [16.38] |
| | | | Stamped* | Unstamped** | Unstamped** |
| 2 | .100 [2.54] | — | — | 5-87456-3 | — |
| 4 | .200 [5.08] | .100 [2.54] | 5-87456-0 | 4-87456-9 | 2-86177-5 |
| 6 | .300 [7.62] | .200 [5.08] | 87456-2 | 87456-1 | 1-86177-8 |
| 8 | .400 [10.16] | .300 [7.62] | 87456-4 | 87456-3 | 2-86177-0 |
| 10 | .500 [12.70] | .400 [10.16] | 87456-6 | 87456-5 | 1-86177-2 |
| 12 | .600 [15.24] | .500 [12.70] | 87456-8 | 87456-7 | 1-86177-3 |
| 14 | .700 [17.78] | .600 [15.24] | 1-87456-0 | 87456-9 | 1-86177-4 |
| 16 | .800 [20.32] | .700 [17.78] | 1-87456-2 | 1-87456-1 | 1-86177-5 |
| 18 | .900 [22.86] | .800 [20.32] | 1-87456-4 | 1-87456-3 | 1-86177-6 |
| 20 | 1.000 [25.40] | .900 [22.86] | 1-87456-6 | 1-87456-5 | 86177-1 |
| 22 | 1.100 [27.94] | 1.000 [25.40] | — | 1-87456-7 | 86177-2 |
| 24 | 1.200 [30.48] | 1.100 [27.94] | 2-87456-0 | 1-87456-9 | 86177-3 |
| 26 | 1.300 [33.02] | 1.200 [30.48] | 2-87456-2 | 2-87456-1 | 86177-4 |
| 28 | 1.400 [35.56] | 1.300 [33.02] | 2-87456-4 | 2-87456-3 | 86177-5 |
| 30 | 1.500 [38.10] | 1.400 [35.56] | 2-87456-6 | 2-87456-5 | 86177-6 |
| 32 | 1.600 [40.64] | 1.500 [38.10] | 2-87456-8 | 2-87456-7 | 86177-7 |
| 34 | 1.700 [43.18] | 1.600 [40.64] | 3-87456-0 | 2-87456-9 | 86177-8 |
| 36 | 1.800 [45.72] | 1.700 [43.18] | 3-87456-2 | 3-87456-1 | 86177-9 |
| 38 | 1.900 [48.26] | 1.800 [45.72] | — | 3-87456-3 | 1-86177-0 |
| 40 | 2.000 [50.80] | 1.900 [48.26] | 3-87456-6 | 3-87456-5 | 1-86177-1 |
| 42 | 2.100 [53.34] | 2.000 [50.80] | 4-87456-4 | 4-87456-3 | — |
| 44 | 2.200 [55.88] | 2.100 [53.34] | 3-87456-8 | 3-87456-7 | 1-86177-7 |
| 48 | 2.400 [60.96] | 2.300 [58.42] | 6-87456-0 | 5-87456-9 | 2-86177-3 |
| 50 | 2.500 [63.50] | 2.400 [60.96] | 4-87456-0 | 3-87456-9 | 2-86177-1 |
| 52 | 2.600 [66.04] | 2.500 [63.50] | 4-87456-2 | 4-87456-1 | 1-86177-9 |
| 54 | 2.700 [68.58] | 2.600 [66.04] | — | 4-87456-5 | — |
| 56 | 2.800 [71.12] | 2.700 [68.58] | — | 6-87456-1 | — |
| 58 | 2.900 [73.66] | 2.800 [71.12] | — | 6-87456-3 | — |
| 60 | 3.000 [76.20] | 2.900 [73.66] | 5-87456-2 | 5-87456-1 | — |
| 64 | 3.200 [81.28] | 3.100 [78.74] | 6-87456-6 | 6-87456-5 | — |
| 66 | 3.300 [83.82] | 3.200 [81.28] | 5-87456-4 | 5-87456-7 | — |
| 70 | 3.500 [88.90] | 3.400 [86.36] | — | 5-87456-5 | 2-86177-4 |
| 72 | 3.600 [91.44] | 3.500 [88.90] | 4-87456-8 | 4-87456-7 | — |

*Cavity identification, part number and date code stamped on housing where size permits.

**No marking on housing.

Notes: 1. Strain reliefs are available and may be purchased separately. Consult TE.
 2. Contact **Extraction/Lance Reset Tool No. 843996-3**.

Note: All part numbers are RoHS compliant.

Mod IV Wire-Applied Housings, Double-Row, .100 x .100 [2.54 x 2.54] Centerline (Continued)

Polarized



Material

Black thermoplastic, flame retardant

Related Product Data

Contacts — pages 211-213
Mateable Headers and Posts — pages 117-131

Technical Documents — pages 277, 278

Product Specification
 108-25007, 108-25019, 108-25020, 108-25021

Application Specification
 114-25003, 114-25016

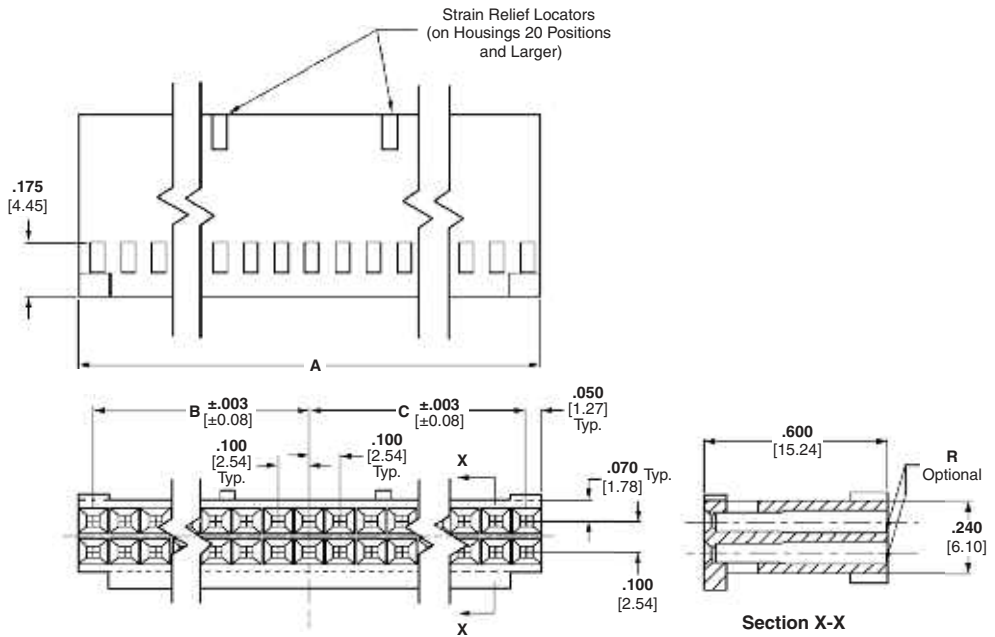

| No. of Pos. | Dimensions | | | Part Nos. | |
|-------------|---------------|---------------|---------------|-----------|-------------|
| | A | B | C | Stamped* | Unstamped** |
| 6 | .300 [7.62] | .100 [2.54] | .100 [2.54] | 87977-1 | 2-87977-8 |
| 8 | .400 [10.16] | .200 [5.08] | .100 [2.54] | 87977-2 | 2-87977-9 |
| 10 | .500 [12.70] | .200 [5.08] | .200 [5.08] | 87977-3 | 3-87977-0 |
| 12 | .600 [15.24] | .300 [7.62] | .200 [5.08] | 87977-4 | 3-87977-1 |
| 14 | .700 [17.78] | .300 [7.62] | .300 [7.62] | 87977-5 | 3-87977-2 |
| 16 | .800 [20.32] | .400 [10.16] | .300 [7.62] | 87977-6 | 3-87977-3 |
| 18 | .900 [22.86] | .400 [10.16] | .400 [10.16] | — | 3-87977-4 |
| 20 | 1.000 [25.40] | .500 [12.70] | .400 [10.16] | 87977-8 | 3-87977-5 |
| 22 | 1.100 [27.94] | .500 [12.70] | .500 [12.70] | — | 3-87977-6 |
| 24 | 1.200 [30.48] | .600 [15.24] | .500 [12.70] | 1-87977-0 | 3-87977-7 |
| 26 | 1.300 [33.02] | .600 [15.24] | .600 [15.24] | 1-87977-1 | 3-87977-8 |
| 28 | 1.400 [35.56] | .700 [17.78] | .600 [15.24] | — | 3-87977-9 |
| 30 | 1.500 [38.10] | .700 [17.78] | .700 [17.78] | — | 4-87977-0 |
| 32 | 1.600 [40.64] | .800 [20.32] | .700 [17.78] | — | 4-87977-1 |
| 34 | 1.700 [43.18] | .800 [20.32] | .800 [20.32] | — | 4-87977-2 |
| 36 | 1.800 [45.72] | .900 [22.86] | .800 [20.32] | — | 4-87977-3 |
| 38 | 1.900 [48.26] | .900 [22.86] | .900 [22.86] | — | 4-87977-4 |
| 40 | 2.000 [50.80] | 1.000 [25.40] | .900 [22.86] | 1-87977-8 | 4-87977-5 |
| 42 | 2.100 [53.34] | 1.000 [25.40] | 1.000 [25.40] | — | 4-87977-6 |
| 44 | 2.200 [55.88] | 1.100 [27.94] | 1.000 [25.40] | — | 4-87977-7 |
| 48 | 2.400 [60.96] | 1.200 [30.48] | 1.100 [27.94] | — | 5-87977-6 |
| 50 | 2.500 [63.50] | 1.200 [30.48] | 1.200 [30.48] | 2-87977-1 | 4-87977-8 |
| 52 | 2.600 [66.04] | 1.300 [33.02] | 1.200 [30.48] | — | 4-87977-9 |
| 54 | 2.700 [68.58] | 1.300 [33.02] | 1.300 [33.02] | — | 5-87977-0 |
| 56 | 2.800 [71.12] | 1.400 [35.56] | 1.300 [33.02] | — | 5-87977-8 |
| 58 | 2.900 [73.66] | 1.400 [35.56] | 1.400 [35.56] | — | 6-87977-0 |
| 60 | 3.000 [76.20] | 1.500 [38.10] | 1.400 [35.56] | 2-87977-4 | 5-87977-1 |
| 64 | 3.200 [81.28] | 1.600 [40.64] | 1.500 [38.10] | — | 6-87977-2 |
| 66 | 3.300 [83.82] | 1.600 [40.64] | 1.600 [40.64] | — | 5-87977-2 |
| 70 | 3.500 [88.90] | 1.700 [43.18] | 1.700 [43.18] | — | 5-87977-3 |
| 72 | 3.600 [91.44] | 1.800 [45.72] | 1.700 [43.18] | — | 5-87977-4 |

*Cavity identification, part number and date code stamped on housing where size permits.

**No marking on housing or strain relief.

Notes: 1. Strain reliefs are available and may be purchased separately. Consult TE.
 2. Contact **Extraction/Lance Reset Tool No. 843996-3**.

Note: All part numbers are RoHS compliant.

Keying Plugs

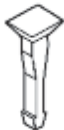

Part No. 86286-1

(Plugs into standard or intermediate pressure receptacle contact)

Material — Natural color nylon

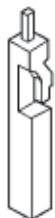

Part No. 87077-2

(Plugs directly into housing)

Mod IV Wire-Applied Housings, Double-Row, .100 x .100 [2.54 x 2.54] Centerline (Continued)

Polarized (with Detent Latching, with and without Strain Relief/Pull Tab)



Material

Black thermoplastic, flame retardant

Related Product Data

Contacts — pages 211-213
Mateable Headers and Posts — pages 117-125, 127-133

Technical Documents — pages 277, 278

Product Specification
 108-25007, 108-25019, 108-25020, 108-25021

Application Specification
 114-25003, 114-25016

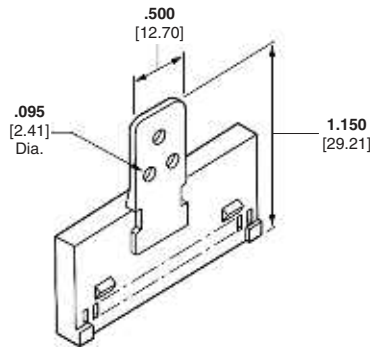
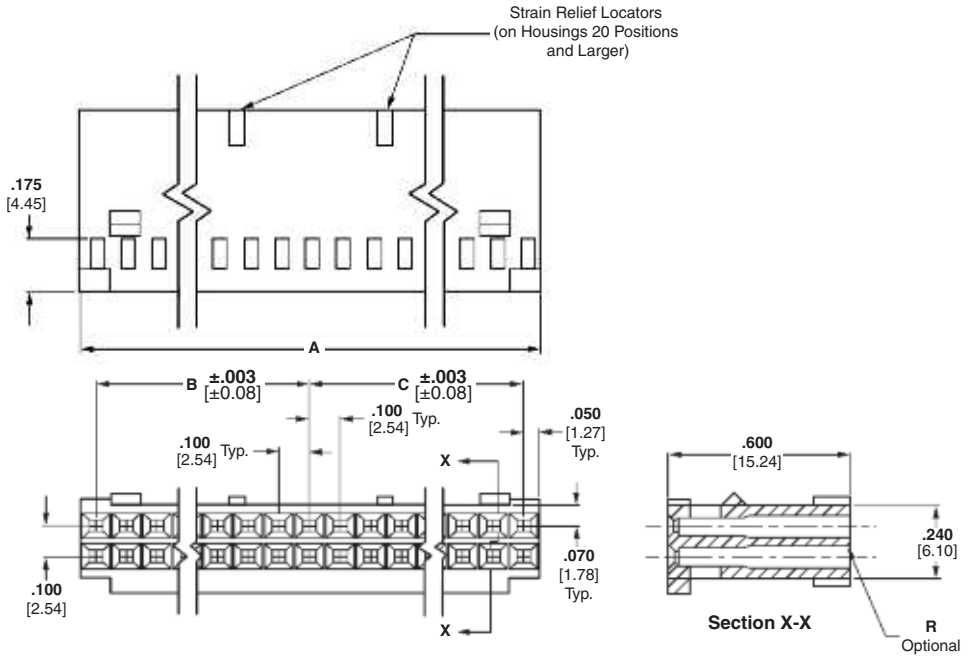

Housing with Strain Relief/Pull Tab
 Strain Relief Part No. 87921-1
 (10 thru 18 positions)

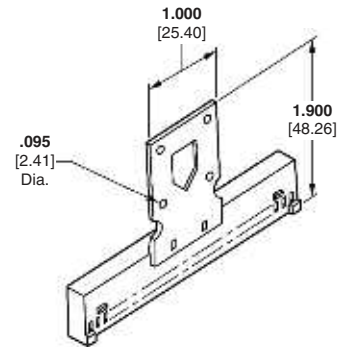

Housing with Strain Relief/Pull Tab
 Strain Relief Part No. 87710-1
 (20 positions and larger)

Keying Plugs

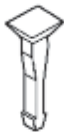

Part No. 86286-1
 (Plugs into standard or intermediate pressure receptacle contact)

Material — Natural color nylon

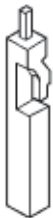

Part No. 87077-2
 (Plugs directly into housing)

| No. of Pos. | Dimensions | | | No. of Detents | Part Nos. | | |
|-------------|--------------|--------------|-------------|----------------|-----------------------|-------------|--------------------|
| | A | B | C | | Without Strain Relief | | With Strain Relief |
| | | | | | Stamped* | Unstamped** | |
| 6 | .300 [7.62] | .100 [2.54] | .100 [2.54] | 1 | 87631-2 | 87631-1 | — |
| 8 | .400 [10.16] | .200 [5.08] | .100 [2.54] | 1 | 87631-4 | 87631-3 | — |
| 10 | .500 [12.70] | .200 [5.08] | .200 [5.08] | 1 | 87631-6 | 87631-5 | 87922-1 |
| 12 | .600 [15.24] | .300 [7.62] | .200 [5.08] | 1 | 87631-8 | 87631-7 | 87922-2 |
| 14 | .700 [17.78] | .300 [7.62] | .300 [7.62] | 1 | 1-87631-0 | 87631-9 | 87922-3 |
| 16 | .800 [20.32] | .400 [10.16] | .300 [7.62] | 1 | 1-87631-2 | 1-87631-1 | 87922-4 |

*Cavity identification, part number and date code stamped on housing and/or strain relief where size permits.

**No marking on housing or strain relief.

- Notes:**
1. The Strain Relief/Pull Tab can be bonded to any thermoplastic connector housing.
 2. Strain reliefs may be purchased separately.
 3. Contact **Extraction/Lance Reset Tool No. 843996-3**.

Note: All part numbers are RoHS compliant.

**Mod IV Wire-Applied Housings, Double-Row,
.100 x .100 [2.54 x 2.54] Centerline** (Continued)

| No. of Pos. | Dimensions | | | No. of Detents | Part Nos. | | |
|-------------|---------------|---------------|---------------|----------------|-----------------------|-------------|--------------------|
| | A | B | C | | Without Strain Relief | | With Strain Relief |
| | | | | | Stamped* | Unstamped** | Stamped* |
| 18 | .900 [22.86] | .400 [10.16] | .400 [10.16] | 1 | 1-87631-4 | 1-87631-3 | 87922-5 |
| 20 | 1.000 [25.40] | .500 [12.70] | .400 [10.16] | 2 | 1-87631-6 | 1-87631-5 | 87733-1 |
| 22 | 1.100 [27.94] | .500 [12.70] | .500 [12.70] | 2 | 1-87631-8 | 1-87631-7 | — |
| 24 | 1.200 [30.48] | .600 [15.24] | .500 [12.70] | 2 | 2-87631-0 | 1-87631-9 | 87733-3 |
| 26 | 1.300 [33.02] | .600 [15.24] | .600 [15.24] | 2 | 2-87631-2 | 2-87631-1 | 87733-4 |
| 28 | 1.400 [35.56] | .700 [17.78] | .600 [15.24] | 2 | 2-87631-4 | 2-87631-3 | — |
| 30 | 1.500 [38.10] | .700 [17.78] | .700 [17.78] | 2 | 2-87631-6 | 2-87631-5 | 87733-6 |
| 32 | 1.600 [40.64] | .800 [20.32] | .700 [17.78] | 2 | 2-87631-8 | 2-87631-7 | 87733-7 |
| 34 | 1.700 [43.18] | .800 [20.32] | .800 [20.32] | 2 | 3-87631-0 | 2-87631-9 | 87733-8 |
| 36 | 1.800 [45.72] | .900 [22.86] | .800 [20.32] | 2 | 3-87631-2 | 3-87631-1 | — |
| 38 | 1.900 [48.26] | .900 [22.86] | .900 [22.86] | 2 | — | 3-87631-3 | — |
| 40 | 2.000 [50.80] | 1.000 [25.40] | .900 [22.86] | 2 | 3-87631-6 | 3-87631-5 | 1-87733-1 |
| 42 | 2.100 [53.34] | 1.000 [25.40] | 1.000 [25.40] | 2 | 3-87631-8 | 3-87631-7 | — |
| 44 | 2.200 [55.88] | 1.100 [27.94] | 1.000 [25.40] | 2 | 4-87631-0 | 3-87631-9 | — |
| 48 | 2.400 [60.96] | 1.200 [30.48] | 1.100 [27.94] | 2 | — | 5-87631-9 | — |
| 50 | 2.500 [63.50] | 1.200 [30.48] | 1.200 [30.48] | 2 | 4-87631-2 | 4-87631-1 | 1-87733-4 |
| 52 | 2.600 [66.04] | 1.300 [33.02] | 1.200 [30.48] | 2 | — | 4-87631-3 | — |
| 54 | 2.700 [68.58] | 1.300 [33.02] | 1.300 [33.02] | 2 | 4-87631-6 | 4-87631-5 | — |
| 58 | 2.900 [73.66] | 1.400 [35.56] | 1.400 [35.56] | 2 | — | 6-87631-3 | — |
| 60 | 3.000 [76.20] | 1.500 [38.10] | 1.400 [35.56] | 2 | 5-87631-2 | 5-87631-1 | 1-87733-7 |
| 64 | 3.200 [81.28] | 1.600 [40.64] | 1.500 [38.10] | 2 | 6-87631-6 | 6-87631-5 | — |
| 66 | 3.300 [83.82] | 1.600 [40.64] | 1.600 [40.64] | 2 | — | 5-87631-3 | — |
| 70 | 3.500 [88.90] | 1.700 [43.18] | 1.700 [43.18] | 2 | — | 5-87631-5 | — |
| 72 | 3.800 [96.52] | 1.800 [45.72] | 1.700 [43.18] | 2 | 5-87631-8 | 5-87631-7 | — |

*Cavity identification, part number and date code stamped on housing and/or strain relief where size permits.
**No marking on housing or strain relief.

- Notes:** 1. The Strain Relief/Pull Tab can be bonded to any thermoplastic connector housing.
2. Strain reliefs may be purchased separately.
3. Contact **Extraction/Lance Reset Tool No. 843996-3**.

Note: All part numbers are RoHS compliant.

Mod IV Wire-Applied Housings, Double-Row, .100 x .100 [2.54 x 2.54] Centerline (Continued)

Center Polarized



Material

Black thermoplastic, flame retardant

Related Product Data

Contacts — pages 211-213
Mateable Headers and Posts —
AMP-LATCH Low Profile Headers, Shrouded — pages 135-140

Technical Documents —
 pages 277, 278

Product Specification
 108-25007, 108-25019, 108-25020,
 108-25021

Application Specification
 114-25003, 114-25016

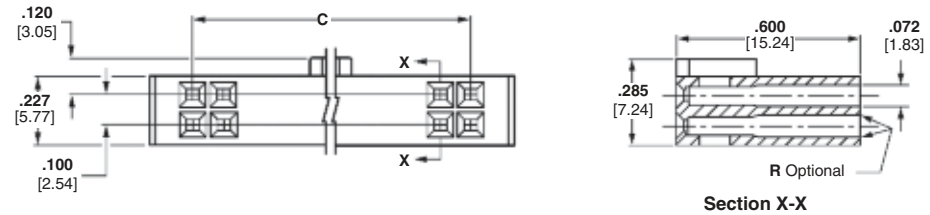
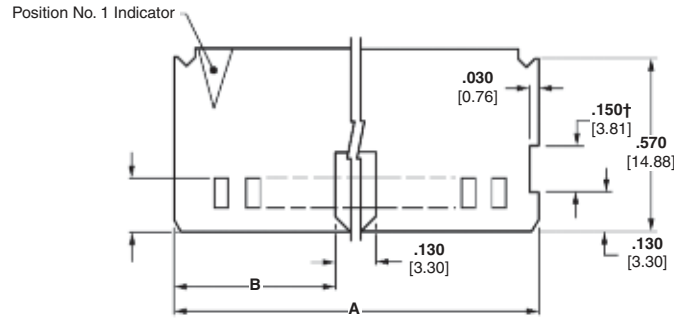

| No. of Pos. | Dimensions | | | Part Nos. (Stamped*) |
|-------------|---------------|---------------|---------------|----------------------|
| | A | B | C | |
| 8 | .580 [14.73] | .225 [5.72] | .300 [7.62] | 1-102387-4 |
| 10 | .680 [17.27] | .275 [6.98] | .400 [10.16] | 102387-1 |
| 14 | .880 [22.35] | .375 [9.53] | .600 [15.24] | 102387-2 |
| 16 | .980 [24.89] | .425 [10.80] | .700 [17.78] | 102387-3 |
| 20 | 1.180 [29.97] | .525 [13.34] | .900 [22.86] | 102387-4 |
| 22 | 1.280 [32.51] | .575 [14.61] | 1.000 [25.40] | 1-102387-5 |
| 24 | 1.380 [35.05] | .625 [15.88] | 1.100 [27.94] | 102387-5 |
| 26 | 1.480 [37.59] | .675 [17.15] | 1.200 [30.48] | 102387-6 |
| 30 | 1.680 [42.67] | .775 [19.69] | 1.400 [35.56] | 102387-7 |
| 34 | 1.880 [47.75] | .875 [22.23] | 1.600 [40.64] | 102387-8 |
| 40 | 2.180 [55.37] | 1.025 [26.04] | 1.900 [48.26] | 102387-9 |
| 44 | 2.380 [60.45] | 1.125 [28.58] | 2.100 [53.34] | 1-102387-3 |
| 50 | 2.680 [68.07] | 1.275 [32.39] | 2.400 [60.96] | 1-102387-0 |
| 60 | 3.180 [80.77] | 1.525 [38.74] | 2.900 [73.66] | 1-102387-1 |
| 64 | 3.380 [85.85] | 1.625 [41.28] | 3.100 [78.74] | 1-102387-2 |

*Cavity identification and TE stamped on housing.

†Non-functional slot is used for gating purposes during injection molding process. This gating feature is not inherent in all production molds. Therefore, the depicted slot will only be present on housings produced on mold tooling requiring this gating feature.

Note: Contact **Extraction/Lance Reset Tool No. 843996-3**.

Keying Plugs

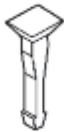

Part No. 86286-1

(Plugs into standard or intermediate pressure receptacle contact)

Material — Natural color nylon

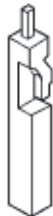

Part No. 87077-2

(Plugs directly into housing)

Note: All part numbers are RoHS compliant.

Short Point, Crimp Snap-In Wire-Applied Contacts and Housings

Product Facts

- Short point of contact mates with .169 [4.29] to .259 [6.58] long post
- Double-row housings are end-to-end and side-to-side stackable
- Terminates 32-20 AWG [0.03-0.6 mm²] discrete wire
- Contacts have insulation support to accept a maximum insulation diameter of .060 [1.52]
- Available with .000015 [0.00038] or .000030 [0.00076] gold duplex, or tin plating
- Mates with .025 [0.64] square posts
- Dual cantilever contact beams for reliable matings
- Locking retention latch provides approximately 3 lb [13.34 N] of retention force
- Unique locking latch design helps prevent latch from protruding through latch window
- Contacts snap into AMPMODU MTE single-row housings
- Double-row housing configurations include .100 [2.54] centerline, plain and polarized
- Housing sizes range from 4 to 52 positions
- Recognized under the Component Program of Underwriters Laboratories Inc., File No. E28476
- Certified by Canadian Standards Association, File No. LR7189
- Produced under a Quality Management System certified to ISO 9001



A copy of the certificate is available upon request

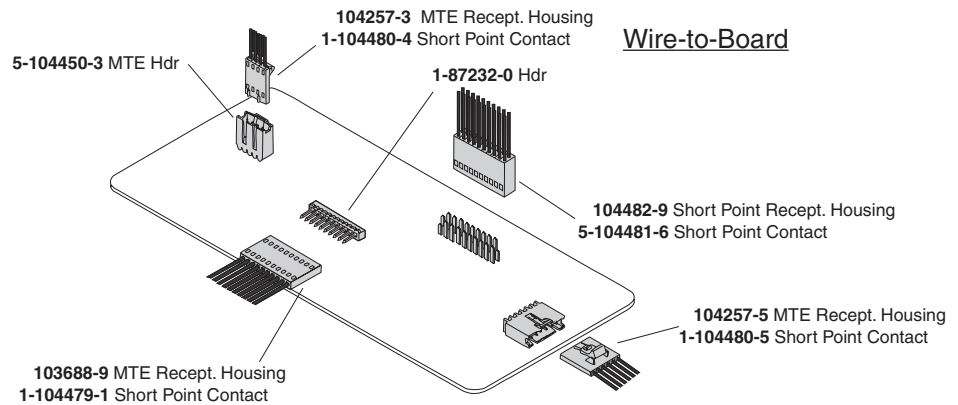
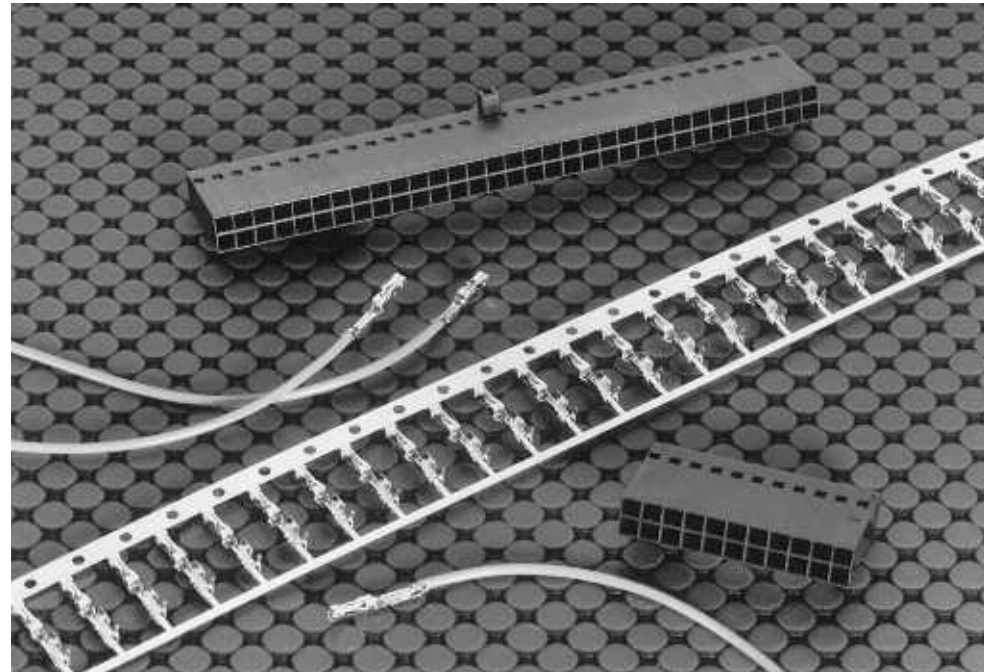

AMPMODU Short Point receptacle contacts are designed to mate with .025 [0.64] square posts. They will mate with posts as short as .169 [4.29].

Short Point double-row housings are end-to-end and side-to-side stackable on .100 [2.54] centers. Contacts also can be used in single-row AMPMODU MTE housings to provide a complete wire-crimp system, or to serve as replacement contacts.

Performance Characteristics

- Contact Current Rating** — 3 amperes
- Termination Resistance** — 12 milliohms (max.)
- Durability** — Ref. Product Specification 108-1472

Note: All part numbers are RoHS compliant.

Short Point Crimp Snap-In Receptacle Contacts

Material and Finish

Copper alloy C7025, plated as follows:

Plating A — Duplex plated .000030 [0.00076] min. gold on contact area, .000050 [0.00127] min. tin in crimp area, with entire contact underplated .000050 [0.00127] min. nickel

Plating B — Duplex plated .000015 [0.00038] min. gold on contact area, .000050 [0.00127] min. tin in crimp area, with entire contact underplated .000050 [0.00127] min. nickel

Plating C — .000100 [0.00254] min. tin over .000050 [0.00127] min. nickel on entire contact

Related Product Data

Performance Characteristics — page 221

Housings used in — Short Point—pages 223, 224

AMPMODU MTE Unloaded Housings — pages 228-233

Application Tooling — page 270-272

Technical Documents — pages 276-278

Product Specification 108-1472

Application Specification 114-25038

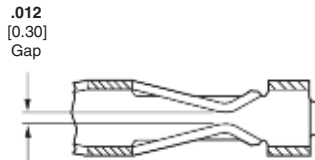
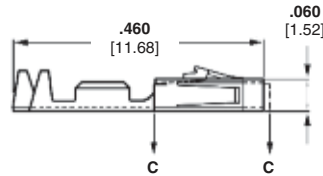
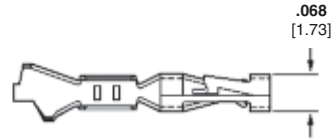

Section C - C



Keying Plug
Part No. 104072-1

Ten plugs are supplied per strip. Order quantity reflects the number of strips required.



Extraction/Lance Reset
Tool No. 843477-1

| Wire Size Range | | Ins. Dia. Range | Finish | Contact Part No. (Standard Pressure) | | Quick-Change Applicator for AMP-O-LECTRIC Machine* | Applicator for AMP-O-MATIC Stripper/Crimper Machine | Hand Tool Nos. |
|-----------------|--------------------|-----------------------|-----------|--------------------------------------|-------------|--|---|----------------|
| AWG | [mm ²] | | | Strip Form | Loose Piece | | | |
| 32-28 | 0.03-0.08 | .025-.060 [0.64-1.52] | Plating A | 1-104481-1 | 1-104481-3 | 567296-2 | 466980-1 | 91518-1 |
| | | | Plating B | 1-104481-0 | 1-104481-2 | | | |
| | | | Plating C | 5-104481-2 | 5-104481-6 | | | |
| 26-22 | 0.13-0.3 | .025-.060 [0.64-1.52] | Plating A | 1-104480-3 | 1-104480-6 | 567297-2 | 466981-1 | 91518-1 |
| | | | Plating B | 1-104480-2 | 1-104480-5 | | | |
| | | | Plating C | 1-104480-7 | 1-104480-4 | | | |
| 24-20 | 0.2-0.5 | .025-.060 [0.64-1.52] | Plating A | 1-104479-0 | 1-104479-3 | 567298-2 | 466982-1 | 91551-1 |
| | | | Plating B | 104479-9 | 1-104479-2 | | | |
| | | | Plating C | 104479-8 | 1-104479-1 | | | |

*For use with Model "K" machines. Call the Tooling/Technical Assistance Center (1-800-722-1111) for part nos. of applicators for use with the Model "G" machines (shown on page 288), as well as other bench machines and fully automatic AMPOMATOR lead making machines.

Note: All part numbers are RoHS compliant.

Short Point Wire-Applied Housings, Double-Row, Non-Polarized, .100 x .100 [2.54 x 2.54] Centerline

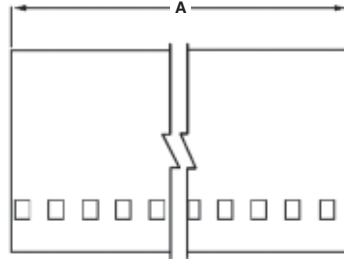

Material

Black thermoplastic, flame retardant, 94V-0 rated

Related Product Data

Performance Characteristics — page 221

Contacts — page 222

Mateable Headers — pages 104, 105

Technical Documents — pages 276-278

Product Specification 108-1472

Application Specification 114-25038

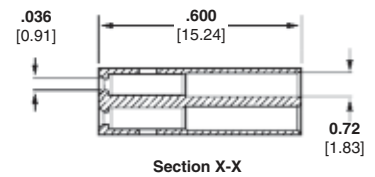
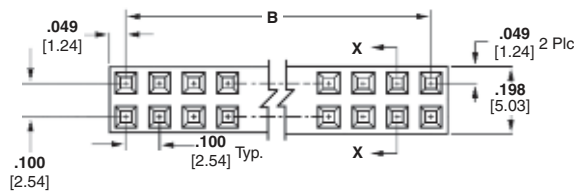

| No. of Pos. | Dimensions | | Housing Part No. |
|-------------|---------------|---------------|------------------|
| | A | B | |
| 4 | .198 [5.03] | .100 [2.54] | 104482-1 |
| 6 | .298 [7.57] | .200 [5.08] | 104482-2 |
| 8 | .398 [10.11] | .300 [7.62] | 104482-3 |
| 10 | .498 [12.65] | .400 [10.16] | 104482-4 |
| 12 | .598 [15.19] | .500 [12.70] | 104482-5 |
| 14 | .698 [17.73] | .600 [15.24] | 104482-6 |
| 16 | .798 [20.27] | .700 [17.78] | 104482-7 |
| 18 | .898 [22.81] | .800 [20.32] | 104482-8 |
| 20 | .998 [25.35] | .900 [22.86] | 104482-9 |
| 22 | 1.098 [27.89] | 1.000 [25.40] | 1-104482-0 |
| 26 | 1.298 [32.97] | 1.200 [30.48] | 1-104482-1 |
| 28 | 1.398 [35.51] | 1.300 [33.02] | 1-104482-2 |
| 30 | 1.498 [38.05] | 1.400 [35.56] | 1-104482-3 |
| 32 | 1.598 [40.59] | 1.500 [38.10] | 1-104482-4 |
| 34 | 1.698 [43.13] | 1.600 [40.64] | 1-104482-5 |
| 36 | 1.798 [45.67] | 1.700 [43.18] | 1-104482-6 |
| 38 | 1.898 [48.21] | 1.800 [45.72] | 1-104482-7 |
| 40 | 1.998 [50.75] | 1.900 [48.26] | 1-104482-8 |
| 44 | 2.198 [55.83] | 2.100 [53.34] | 1-104482-9 |
| 52 | 2.598 [65.99] | 2.500 [63.50] | 2-104482-0 |

Note: All part numbers are RoHS compliant.

Short Point Wire-Applied Housings, Double-Row, Polarized, .100 x .100 [2.54 x 2.54] Centerline

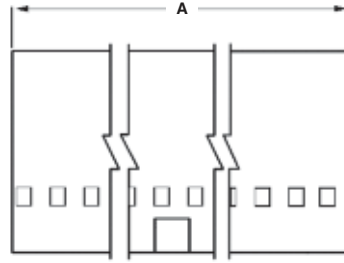

Material

Black thermoplastic, flame retardant, 94V-0 rated

Related Product Data

Performance Characteristics — page 221

Contacts — page 222

Mateable Headers — pages 104, 105, 135-138

Technical Documents — pages 276-278

Product Specification 108-1472

Application Specification 114-25038

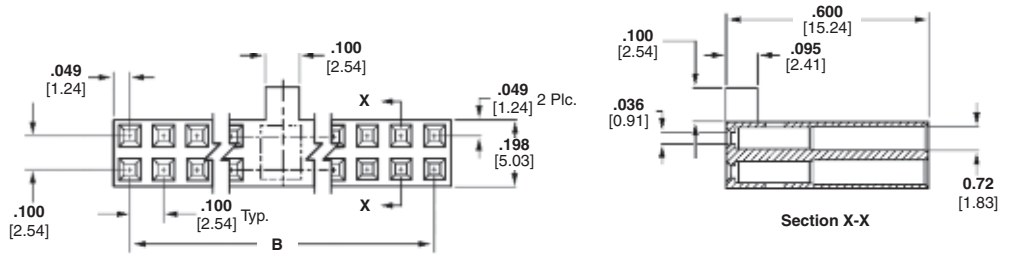



| No. of Pos. | Dimensions | | Housing Part No. |
|-------------|---------------|---------------|------------------|
| | A | B | |
| 8 | .398 [10.11] | .300 [7.62] | 104483-1 |
| 10 | .498 [12.65] | .400 [10.16] | 1-104483-1 |
| 12 | .598 [15.19] | .500 [12.70] | 1-104483-2 |
| 14 | .698 [17.73] | .600 [15.24] | 104483-9 |
| 18 | .898 [22.81] | .800 [20.32] | 104483-2 |
| 20 | .998 [25.35] | .900 [22.86] | 104483-3 |
| 26 | 1.298 [32.97] | 1.200 [30.48] | 104483-4 |
| 30 | 1.498 [38.05] | 1.400 [35.56] | 104483-5 |
| 38 | 1.898 [48.21] | 1.800 [45.72] | 104483-6 |
| 50 | 2.498 [63.45] | 2.400 [60.96] | 1-104483-3 |
| 52 | 2.598 [65.99] | 2.500 [63.50] | 1-104483-0 |
| 54 | 2.698 [68.53] | 2.600 [66.04] | 104483-7 |
| 64 | 3.198 [81.23] | 3.100 [78.74] | 104483-8 |

Note: Other sizes can be made available on request.

Note: All part numbers are RoHS compliant.

MTE Interconnection System

Product Facts

- Receptacle assemblies mate with .025 [0.64] sq. posts; mating post length is .200 [5.08] min., .250 [6.35] max.
- Proven AMPMODU receptacle contact design; dual cantilever beams, built-in anti-overstress, completely enclosed "box" design, standard or high-pressure
- Insulation displacement technology
- Two contact sizes for terminating 30-22 AWG [0.05-0.3 mm²] wire range; .054 [1.37] max. insulation diameter with an insulation wall thickness of .015 [0.38] max.
- Choice of gold duplex or tin plated contacts
- Interchangeable crimp snap-in pin and receptacle contacts available
- Housing sizes 2 through 25 positions, single-row .100 [2.54] centers
- Plain housings are end-to-end and/or back-to-back stackable for open pin field applications
- Optional header with "swaged tail" feature helps prevent movement prior to flow soldering
- Integral latch provides positive retention between header and receptacle housing
- Coupling shrouds permit ganging of smaller connectors with guide ribs to form larger single- or double-row latching connectors
- Mass terminating tooling provides lowest applied cost for most production needs
- SMT and SMT compatible, high-temp headers available
- Recognized under the Component Program of Underwriters Laboratories Inc., File No. E28476 
- Certified by Canadian Standards Association, File No. LR7189 

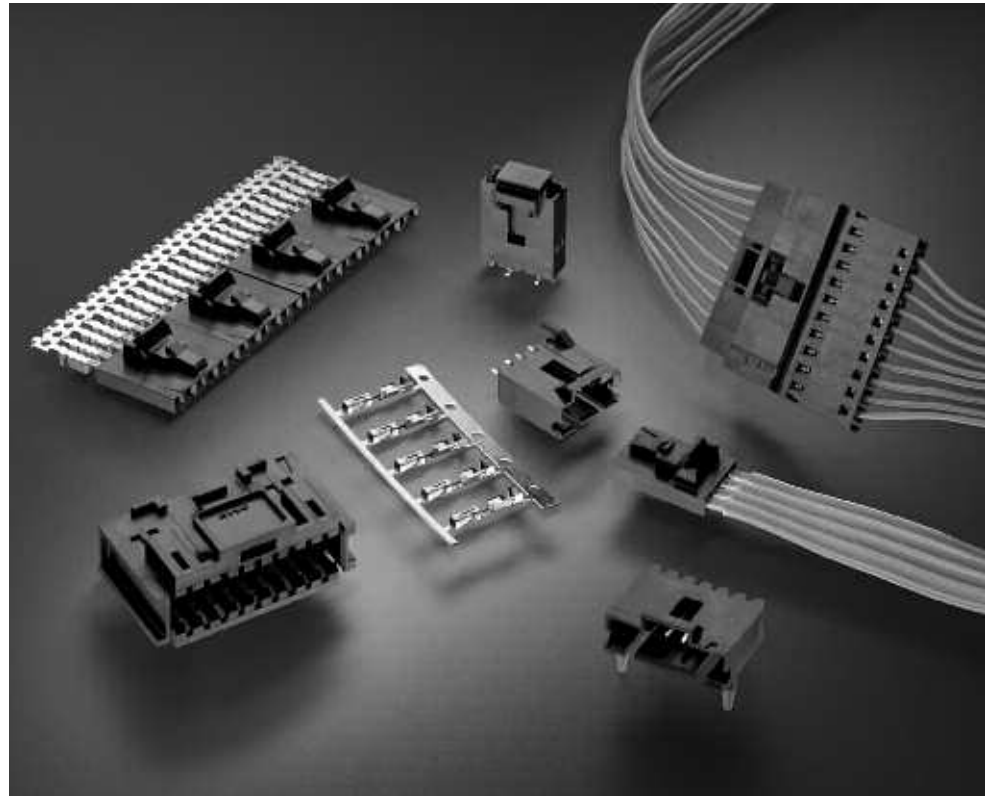

The AMPMODU MTE Interconnection System offers both wire-to-board and wire-to-wire connectors using .025 [0.64] sq. post technology.

The AMPMODU MTE Interconnection System consists of single-row housings with contacts preloaded on .100 [2.54] centers. Housings are furnished with contacts partially inserted, leaving the termination areas exposed. Final contact insertion can be accomplished automatically with TE application equipment, and manually when terminated with the TE pistol grip hand tool.

The heart of the system is the insulation displacement contact design, featured in both pin and receptacle contacts. The receptacle contact, available in either

standard or high-pressure, features dual cantilever beams in an enclosed "box." The post stop helps prevent a mating post from disturbing the wire termination and also limits the mating depth of a long post to protect a wrap-type termination at the base of the post. The forward contact stop helps prevent contact overinsertion prior to termination. All contacts are furnished on carrier strips which are interlocked for stability and positive location during termination.

Single-row housings are available in sizes 2 through 25 positions. Included are three styles of receptacle housings—plain, polarized/latching and ribbed and two styles of pin housings, shrouded with polarizing/latching feature and ribbed.

Performance Specifications

Electrical Characteristics

Contact Current Rating —

3 amperes for single contact in free air (Amperage could vary due to ambient temperature, wire size and duty cycles.)

Contact Termination Resistance —

15 milliohms (max.)

Dielectric Withstanding Voltage —

At Sea Level—600 VAC, rms
At 70,000 Ft. [21 336 m]—225 VAC, rms

Insulation Resistance —

5,000 megohms (min.)

Environmental Characteristics

Operating Temperature —

-65°C to +105°C

Vibration —

15 G's (gold), 10 G's (tin)

Physical Shock —

50 G's

Industrial Mixed Flow Gasing —

Class 1 (20 days) (gold)

Product Specification

108-25034

Application Specification

114-25026

MTE Interconnection System (Continued)

Wire-to-Board

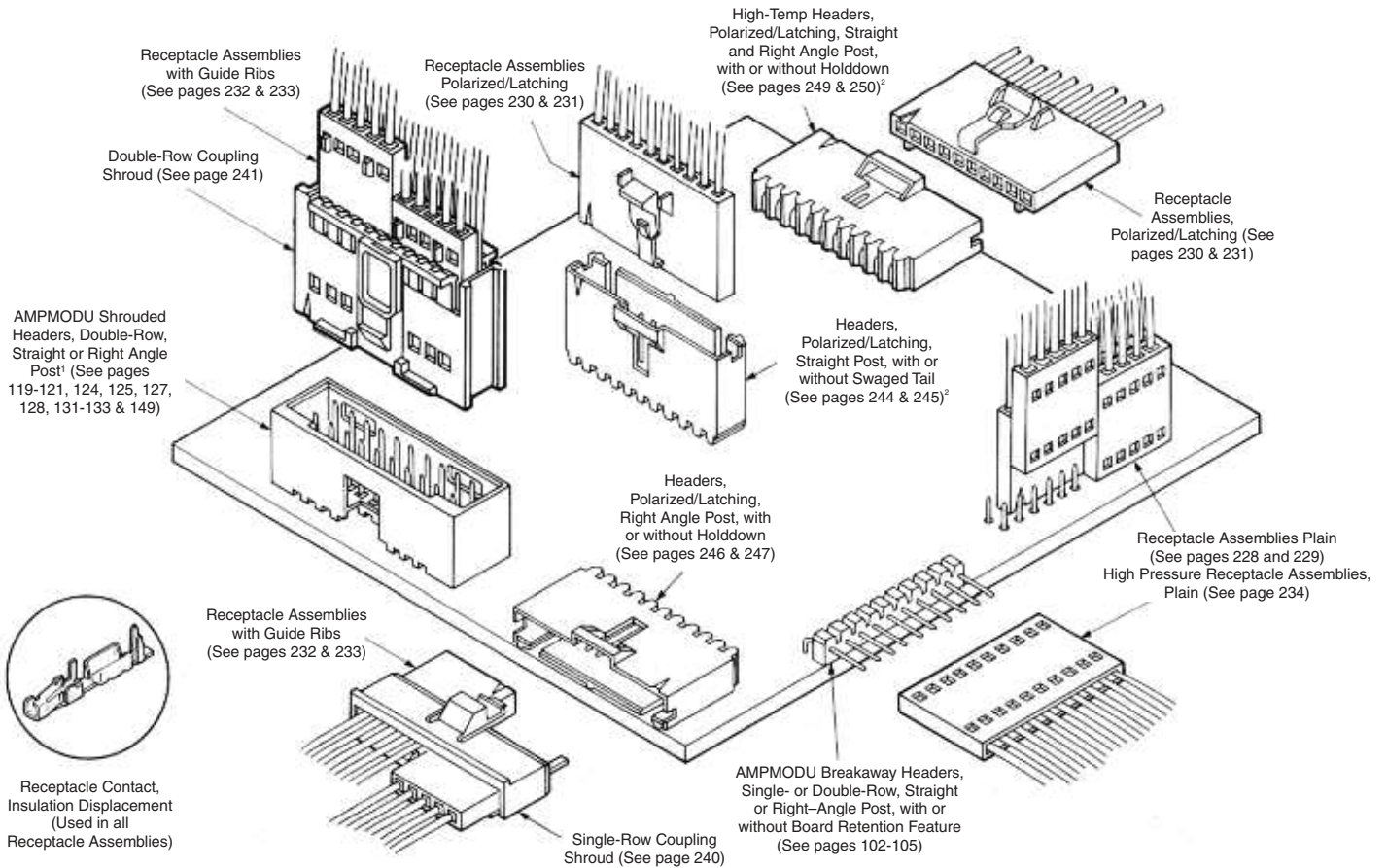

¹Mating AMPMODU Double-Row Shrouded Header Assemblies must have .318 [8.08] mating post length and .150 [3.81] dimension from centerline of last post to inside of end shroud wall.

²Surface Mount Right-Angle and Vertical Headers are also available (see pages 251 and 252)

MTE Interconnection System

5

MTE Interconnection System (Continued)

Wire-to-Wire

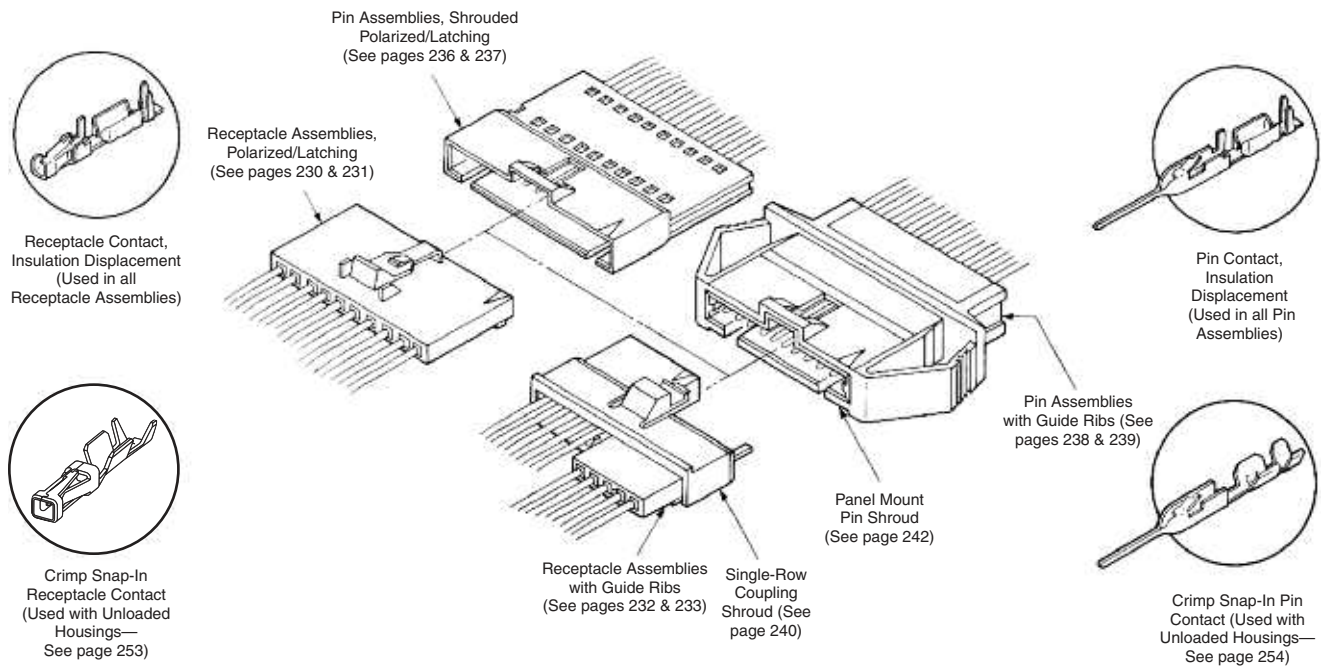

Note: For wire-to-wire applications shown above, all pin and receptacle assembly combinations are intermateable.

MTE Receptacle Assemblies—Plain, Single-Row, .100 [2.54] Centerline



Preassembled housings in strip form are available in positions 2 thru 12. For ease of handling, positions 2 thru 5 are recommended when using the TE Manual Pistol Grip Tool.

Material and Finish

Housing — Black thermoplastic, 94V-0 rated

Contacts — Phosphor Bronze, plated as follows:

Plating A — Duplex plated .000030 [0.00076] gold on contact area, .000050 [0.00127] min. tin in crimp area, with entire contact underplated .000050 [0.00127] nickel

Plating B — Duplex plated .000015 [0.00038] gold on contact area, .000050 [0.00127] min. tin in crimp area, with entire contact underplated .000050 [0.00127] nickel

Plating C — .000100 [0.00254] tin over .000050 [0.00127] nickel on entire contact

Note: Insulation displacement contacts accept an insulation diameter of .030 [0.76] min. to .054 [1.37] max. with an insulation wall thickness of .015 [0.38] max. Mating post length for preloaded housings is .200 [5.08] min., .250 [6.35] max.

Related Product Data

Mateable AMPMODU Products Breakaway Headers — pages 102-110 (with .230 mating length)

Reeled Breakaway Headers — pages 106, 107 (with .230 mating length)

Machine Applied Bandolier Posts — page 163

Single-Row Shrouded Headers with .066 [1.68] End Dimension — pages 115, 116

Interchangeable Crimp Contacts (Short Point) — page 253

Application Tooling — page 273

Performance Specifications — page 225

Technical Documents — pages 277, 278

Product Specification 108-25034

Application Specification 114-25026

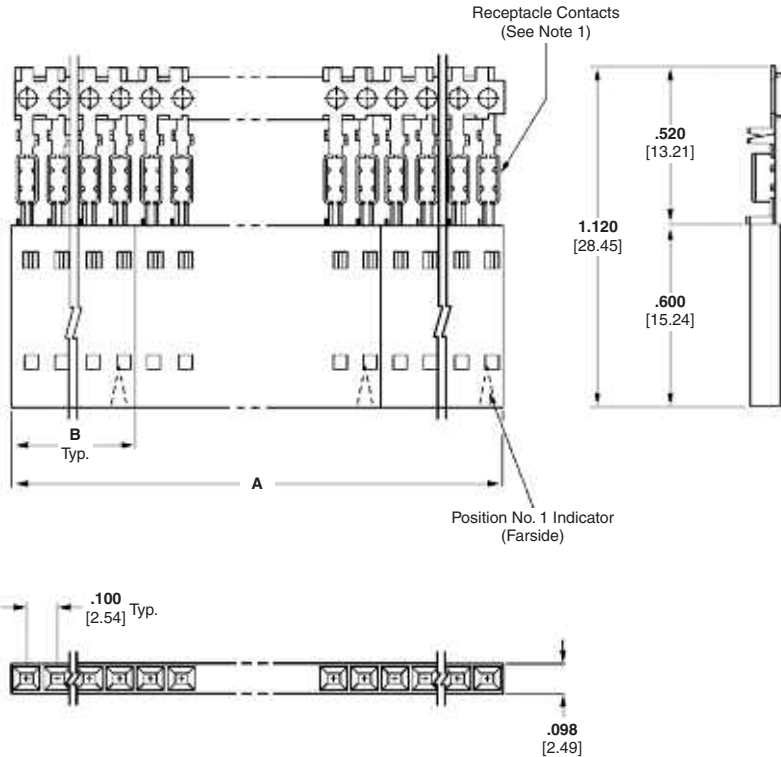

These receptacle assemblies with plain housings can be stacked end-to-end and/or side-to-side for single or double-row connections to an open pin field with a .100 [2.54] centerline grid.

MTE Receptacle Assemblies

5

MTE Receptacle Assemblies—Strip Form Plain, Single-Row, .100 [2.54] Centerline (Continued)

| No. of Pos. | Dimensions | | Housing Quantities Per Strip Segment | Strip Form Receptacle Assembly 30-26 AWG [0.05-0.15mm ²] Wire | | | Strip Form Receptacle Assembly 26-22 AWG [0.12-0.3mm ²] Wire | | | Unloaded Housings |
|-------------|---------------|---------------|--------------------------------------|---|------------|------------|--|------------|------------|-------------------|
| | A | B | | Plating A | Plating B | Plating C | Plating A | Plating B | Plating C | |
| 2 | 2.000 [50.80] | .198 [5.03] | 10 | 5-103979-1 | 5-103978-1 | 5-103977-1 | 5-103976-1 | 5-103975-1 | 5-103974-1 | 103688-1 |
| 3 | 2.400 [60.96] | .298 [7.57] | 8 | 5-103979-2 | 5-103978-2 | 5-103977-2 | 5-103976-2 | 5-103975-2 | 5-103974-2 | 103688-2 |
| 4 | 1.990 [50.55] | .398 [10.11] | 5 | 5-103979-3 | 5-103978-3 | 5-103977-3 | 5-103976-3 | 5-103975-3 | 5-103974-3 | 103688-3 |
| 5 | 1.990 [50.55] | .498 [12.65] | 4 | 5-103979-4 | 5-103978-4 | 5-103977-4 | 5-103976-4 | 5-103975-4 | 5-103974-4 | 103688-4 |
| 6 | 2.390 [60.71] | .598 [15.19] | 4 | 5-103979-5 | 5-103978-5 | 5-103977-5 | 5-103976-5 | 5-103975-5 | 5-103974-5 | 103688-5 |
| 7 | 1.400 [35.56] | .698 [17.73] | 2 | 5-103979-6 | 5-103978-6 | 5-103977-6 | 5-103976-6 | 5-103975-6 | 5-103974-6 | 103688-6 |
| 8 | 1.600 [40.64] | .798 [20.27] | 2 | 5-103979-7 | 5-103978-7 | 5-103977-7 | 5-103976-7 | 5-103975-7 | 5-103974-7 | 103688-7 |
| 9 | 1.800 [45.72] | .898 [22.81] | 2 | 5-103979-8 | 5-103978-8 | 5-103977-8 | 5-103976-8 | 5-103975-8 | 5-103974-8 | 103688-8 |
| 10 | 2.000 [50.80] | .998 [23.35] | 2 | 5-103979-9 | 5-103978-9 | 5-103977-9 | 5-103976-9 | 5-103975-9 | 5-103974-9 | 103688-9 |
| 11 | 2.200 [55.88] | 1.098 [27.89] | 2 | 6-103979-0 | 6-103978-0 | 6-103977-0 | 6-103976-0 | 6-103975-0 | 6-103974-0 | 1-103688-0 |
| 12 | 2.400 [60.96] | 1.198 [30.43] | 2 | 6-103979-1 | 6-103978-1 | 6-103977-1 | 6-103976-1 | 6-103975-1 | 6-103974-1 | 1-103688-1 |

MTE Receptacle Assemblies—Individual Form Plain, Single-Row, .100 [2.54] Centerline

| No. of Pos. | Dimensions B | Individual Receptacle Assembly 30-26 AWG [0.05-0.15mm ²] Wire | | | Individual Receptacle Assembly 26-22 AWG [0.12-0.3mm ²] Wire | | | Unloaded Housings |
|-------------|---------------|---|------------|------------|--|------------|------------|-------------------|
| | | Plating A | Plating B | Plating C | Plating A | Plating B | Plating C | |
| 13 | 1.298 [32.96] | 6-103903-2 | 6-103684-2 | 6-103685-2 | 6-103902-2 | 6-103686-2 | 6-103687-2 | 1-103688-2 |
| 14 | 1.398 [35.51] | 6-103903-3 | 6-103684-3 | 6-103685-3 | 6-103902-3 | 6-103686-3 | 6-103687-3 | 1-103688-3 |
| 15 | 1.498 [38.05] | 6-103903-4 | 6-103684-4 | 6-103685-4 | 6-103902-4 | 6-103686-4 | 6-103687-4 | 1-103688-4 |
| 16 | 1.598 [40.59] | 6-103903-5 | 6-103684-5 | 6-103685-5 | 6-103902-5 | 6-103686-5 | 6-103687-5 | 1-103688-5 |
| 17 | 1.698 [43.13] | 6-103903-6 | 6-103684-6 | 6-103685-6 | 6-103902-6 | 6-103686-6 | 6-103687-6 | 1-103688-6 |
| 18 | 1.798 [45.67] | 6-103903-7 | 6-103684-7 | 6-103685-7 | 6-103902-7 | 6-103686-7 | 6-103687-7 | 1-103688-7 |
| 19 | 1.898 [48.20] | 6-103903-8 | 6-103684-8 | 6-103685-8 | 6-103902-8 | 6-103686-8 | 6-103687-8 | 1-103688-8 |
| 20 | 1.998 [50.75] | 6-103903-9 | 6-103684-9 | 6-103685-9 | 6-103902-9 | 6-103686-9 | 6-103687-9 | 1-103688-9 |
| 21 | 2.098 [53.29] | 7-103903-0 | 7-103684-0 | 7-103685-0 | 7-103902-0 | 7-103686-0 | 7-103687-0 | 2-103688-0 |
| 22 | 2.198 [55.83] | 7-103903-1 | 7-103684-1 | 7-103685-1 | 7-103902-1 | 7-103686-1 | 7-103687-1 | 2-103688-1 |
| 23 | 2.298 [58.37] | 7-103903-2 | 7-103684-2 | 7-103685-2 | 7-103902-2 | 7-103686-2 | 7-103687-2 | 2-103688-2 |
| 24 | 2.398 [60.91] | 7-103903-3 | 7-103684-3 | 7-103685-3 | 7-103902-3 | 7-103686-3 | 7-103687-3 | 2-103688-3 |
| 25 | 2.498 [63.45] | 7-103903-4 | 7-103684-4 | 7-103685-4 | 7-103902-4 | 7-103686-4 | 7-103687-4 | 2-103688-4 |

- Notes:** 1. Receptacle assemblies are furnished with strip contacts partially inserted into housing—contacts latched into “preload” windows. Contacts are fully inserted into housings automatically when terminated with TE application machines, or manually when terminated with TE pistol grip hand tool.
 2. Use **Extraction/Lance Reset Tool No. 843477-1** to remove receptacle contacts.
 3. Keying plugs are available, see page 253.

Note: All part numbers are RoHS compliant.

MTE Receptacle Assemblies—Polarized/Latching, Single-Row, .100 [2.54] Centerline



Preassembled housings in strip form are available in positions 2 thru 12. For ease of handling, positions 2 thru 5 are recommended when using the TE Manual Pistol Grip Tool.

Material and Finish

Housing — Black thermoplastic, 94V-0 rated

Contacts — Phosphor Bronze, plated as follows:

Plating A — Duplex plated .000030 [0.00076] gold on contact area, .000050 [0.00127] min. tin in crimp area, with entire contact underplated .000050 [0.00127] nickel

Plating B — Duplex plated .000015 [0.00038] gold on contact area, .000050 [0.00127] min. tin in crimp area, with entire contact underplated .000050 [0.00127] nickel

Plating C — .000100 [0.00254] tin over .000050 [0.00127] nickel on entire contact

Note: Insulation displacement contacts accept an insulation diameter of .030 [0.76] min. to .054 [1.37] max. with an insulation wall thickness of .015 [0.38] max. Mating post length for preloaded housings is .200 [5.08] min., .250 [6.35] max.

Related Product Data

Mateable AMPMODU Products

Pin Assemblies (Polarized/Latching) — pages 236, 237

Pin Assemblies with Guide Ribs (installed in Panel Mount Pin Shroud) — pages 238, 239, 242

Headers (Polarized/Latching) — pages 244-252

Interchangeable Crimp Contacts (Short Point) — page 253

Application Tooling — page 273

Performance Specifications — page 225

Technical Documents — pages 277, 278

Product Specification
108-25034

Application Specification
114-25026

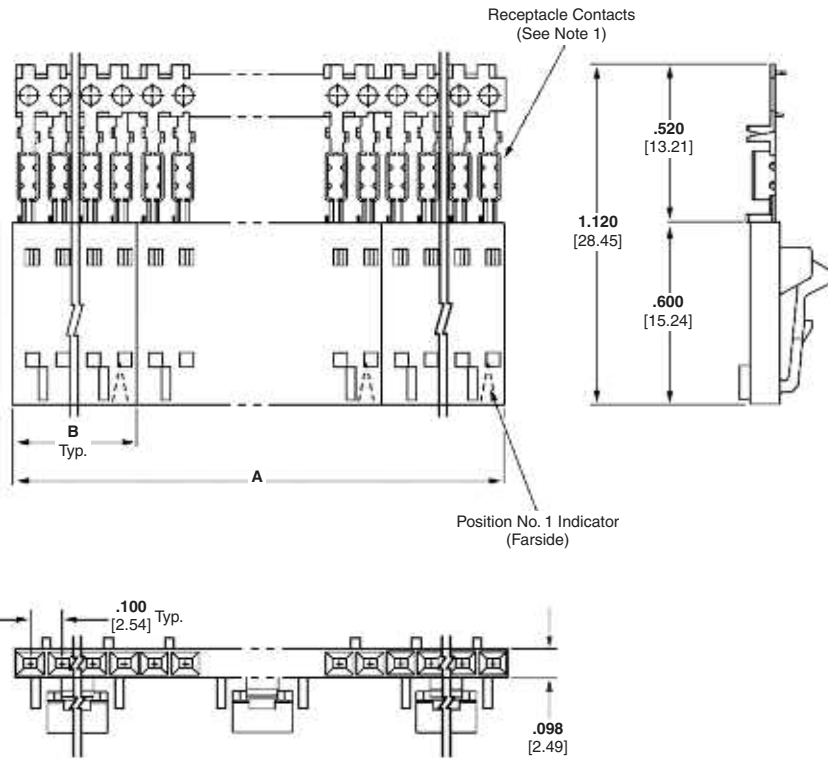

MTE Receptacle Assemblies—Strip Form Polarized/Latching, Single-Row, .100 [2.54] Centerline (Continued)

| No. of Pos. | Dimensions | | Housing Quantities Per Strip Segment | Strip Form Receptacle Assembly 30-26 AWG [0.05-0.15mm ²] Wire | | | Strip Form Receptacle Assembly 26-22 AWG [0.12-0.3mm ²] Wire | | | Unloaded Housings |
|-------------|---------------|---------------|--------------------------------------|---|------------|------------|--|------------|------------|-------------------|
| | A | B | | Plating A | Plating B | Plating C | Plating A | Plating B | Plating C | |
| 2 | 2.000 [50.80] | .198 [5.03] | 10 | 5-103961-1 | 5-103960-1 | 5-103959-1 | 5-103958-1 | 5-103957-1 | 5-103956-1 | 104257-1 |
| 3 | 2.400 [60.96] | .298 [7.57] | 8 | 5-103961-2 | 5-103960-2 | 5-103959-2 | 5-103958-2 | 5-103957-2 | 5-103956-2 | 104257-2 |
| 4 | 1.990 [50.55] | .398 [10.11] | 5 | 5-103961-3 | 5-103960-3 | 5-103959-3 | 5-103958-3 | 5-103957-3 | 5-103956-3 | 104257-3 |
| 5 | 1.990 [50.55] | .498 [12.65] | 4 | 5-103961-4 | 5-103960-4 | 5-103959-4 | 5-103958-4 | 5-103957-4 | 5-103956-4 | 104257-4 |
| 6 | 2.390 [60.71] | .598 [15.19] | 4 | 5-103961-5 | 5-103960-5 | 5-103959-5 | 5-103958-5 | 5-103957-5 | 5-103956-5 | 104257-5 |
| 7 | 1.400 [35.56] | .698 [17.73] | 2 | 5-103961-6 | 5-103960-6 | 5-103959-6 | 5-103958-6 | 5-103957-6 | 5-103956-6 | 104257-6 |
| 8 | 1.600 [40.64] | .798 [20.27] | 2 | 5-103961-7 | 5-103960-7 | 5-103959-7 | 5-103958-7 | 5-103957-7 | 5-103956-7 | 104257-7 |
| 9 | 1.800 [45.72] | .898 [22.81] | 2 | 5-103961-8 | 5-103960-8 | 5-103959-8 | 5-103958-8 | 5-103957-8 | 5-103956-8 | 104257-8 |
| 10 | 2.000 [50.80] | .998 [23.35] | 2 | 5-103961-9 | 5-103960-9 | 5-103959-9 | 5-103958-9 | 5-103957-9 | 5-103956-9 | 104257-9 |
| 11 | 2.200 [55.88] | 1.098 [27.89] | 2 | 6-103961-0 | 6-103960-0 | 6-103959-0 | 6-103958-0 | 6-103957-0 | 6-103956-0 | 1-104257-0 |
| 12 | 2.400 [60.96] | 1.198 [30.43] | 2 | 6-103961-1 | 6-103960-1 | 6-103959-1 | 6-103958-1 | 6-103957-1 | 6-103956-1 | 1-104257-1 |

MTE Receptacle Assemblies—Individual Form Polarized/Latching, Single-Row, .100 [2.54] Centerline

| No. of Pos. | Dimensions B | Individual Receptacle Assembly 30-26 AWG [0.05-0.15mm ²] Wire | | | Individual Receptacle Assembly 26-22 AWG [0.12-0.3mm ²] Wire | | | Unloaded Housings |
|-------------|---------------|---|------------|------------|--|------------|------------|-------------------|
| | | Plating A | Plating B | Plating C | Plating A | Plating B | Plating C | |
| 13 | 1.298 [32.96] | 6-103897-2 | 6-103640-2 | 6-103641-2 | 6-103734-2 | 6-103644-2 | 6-103645-2 | 1-104257-2 |
| 14 | 1.398 [35.51] | 6-103897-3 | 6-103640-3 | 6-103641-3 | 6-103734-3 | 6-103644-3 | 6-103645-3 | 1-104257-3 |
| 15 | 1.498 [38.05] | 6-103897-4 | 6-103640-4 | 6-103641-4 | 6-103734-4 | 6-103644-4 | 6-103645-4 | 1-104257-4 |
| 16 | 1.598 [40.59] | 6-103897-5 | 6-103640-5 | 6-103641-5 | 6-103734-5 | 6-103644-5 | 6-103645-5 | 1-104257-5 |
| 17 | 1.698 [43.13] | 6-103897-6 | 6-103640-6 | 6-103641-6 | 6-103734-6 | 6-103644-6 | 6-103645-6 | 1-104257-6 |
| 18 | 1.798 [45.67] | 6-103897-7 | 6-103640-7 | 6-103641-7 | 6-103734-7 | 6-103644-7 | 6-103645-7 | 1-104257-7 |
| 19 | 1.898 [48.20] | 6-103897-8 | 6-103640-8 | 6-103641-8 | 6-103734-8 | 6-103644-8 | 6-103645-8 | 1-104257-8 |
| 20 | 1.998 [50.75] | 6-103897-9 | 6-103640-9 | 6-103641-9 | 6-103734-9 | 6-103644-9 | 6-103645-9 | 1-104257-9 |
| 21 | 2.098 [53.29] | 7-103897-0 | 7-103640-0 | 7-103641-0 | 7-103734-0 | 7-103644-0 | 7-103645-0 | 2-104257-0 |
| 22 | 2.198 [55.83] | 7-103897-1 | 7-103640-1 | 7-103641-1 | 7-103734-1 | 7-103644-1 | 7-103645-1 | 2-104257-1 |
| 23 | 2.298 [58.37] | 7-103897-2 | 7-103640-2 | 7-103641-2 | 7-103734-2 | 7-103644-2 | 7-103645-2 | 2-104257-2 |
| 24 | 2.398 [60.91] | 7-103897-3 | 7-103640-3 | 7-103641-3 | 7-103734-3 | 7-103644-3 | 7-103645-3 | 2-104257-3 |
| 25 | 2.498 [63.45] | 7-103897-4 | 7-103640-4 | 7-103641-4 | 7-103734-4 | 7-103644-4 | 7-103645-4 | 2-104257-4 |

- Notes:** 1. Receptacle assemblies are furnished with strip contacts partially inserted into housing—contacts latched into “preload” windows. Contacts are fully inserted into housings automatically when terminated with TE application machines, or manually when terminated with TE pistol grip hand tool.
 2. Use **Extraction/Lance Reset Tool No. 843477-1** to remove receptacle contacts.
 3. Keying plugs are available, see page 253.

Note: All part numbers are RoHS compliant.

MTE Receptacle Assemblies—Guide Ribs, Single-Row, .100 [2.54] Centerline



Preassembled housings in strip form are available in positions 2 thru 12. For ease of handling, positions 2 thru 5 are recommended when using the TE Manual Pistol Grip Tool.

Material and Finish

Housing — Black thermoplastic, 94V-0 rated

Contacts — Phosphor Bronze, plated as follows:

Plating A — Duplex plated .000030 [0.00076] gold on contact area, .000050 [0.00127] min. tin in crimp area, with entire contact underplated .000050 [0.00127] nickel

Plating B — Duplex plated .000015 [0.00038] gold on contact area, .000050 [0.00127] min. tin in crimp area, with entire contact underplated .000050 [0.00127] nickel

Plating C — .000100 [0.00254] tin over .000050 [0.00127] nickel on entire contact

Note: Insulation displacement contacts accept an insulation diameter of .030 [0.76] min. to .054 [1.37] max. with an insulation wall thickness of .015 [0.38] max. Mating post length for preloaded housings is .200 [5.08] min., .250 [6.35] max.

Related Product Data

Coupling Shrouds used with —
Single-Row — page 240
Double-Row — page 241

Mateable AMPMODU Products (with Receptacle Assemblies Installed in Single-Row Coupling Shrouds) —

Pin Assemblies (Polarized/Latching) — pages 236, 237

Pin Assemblies with Guide Ribs (installed in Panel Mount Pin Shroud) — pages 238, 239, 242

Headers (Polarized/Latching) — pages 244-252

Mateable AMPMODU Products (with Receptacle Assemblies Installed in Double-Row Coupling Shrouds) —

Headers, Shrouded, Double-Row (.318 [8.08] mating post length, .150 [3.81] end dimension) — pages 119-121, 124, 125, 128, 129, 131-133

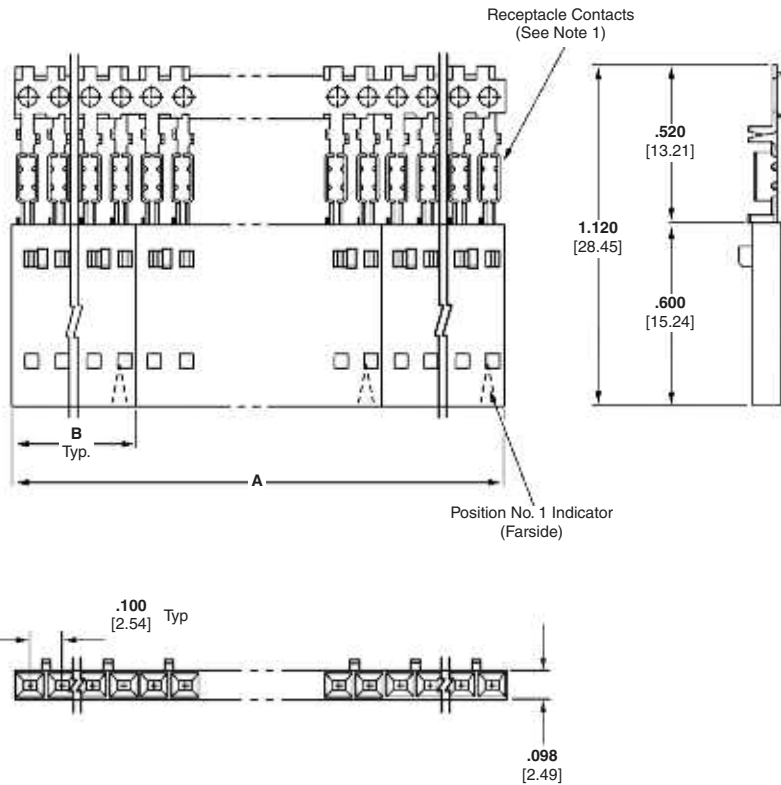

Interchangeable Crimp Contacts—
 (Short Point) — page 253

Application Tooling — page 273

Performance Specifications — page 225

Technical Documents — pages 277, 278

Product Specification
 108-25034

Application Specification
 114-25026

MTE Receptacle Assemblies—Strip Form with Guide Ribs, Single-Row, .100 [2.54] Centerline (Continued)

| No. of Pos. | Dimensions | | Housing Quantities Per Strip Segment | Strip Form Receptacle Assembly 30-26 AWG [0.05-0.15mm ²] Wire | | | Strip Form Receptacle Assembly 26-22 AWG [0.12-0.3mm ²] Wire | | | Unloaded Housings |
|-------------|---------------|---------------|--------------------------------------|---|------------|------------|--|------------|------------|-------------------|
| | A | B | | Plating A | Plating B | Plating C | Plating A | Plating B | Plating C | |
| 2 | 2.000 [50.80] | .198 [5.03] | 10 | 5-103973-1 | 5-103972-1 | 5-103971-1 | 5-103970-1 | 5-103969-1 | 5-103968-1 | 103648-1 |
| 3 | 2.400 [60.96] | .298 [7.57] | 8 | 5-103973-2 | 5-103972-2 | 5-103971-2 | 5-103970-2 | 5-103969-2 | 5-103968-2 | 103648-2 |
| 4 | 1.990 [50.55] | .398 [10.11] | 5 | 5-103973-3 | 5-103972-3 | 5-103971-3 | 5-103970-3 | 5-103969-3 | 5-103968-3 | 103648-3 |
| 5 | 1.990 [50.55] | .498 [12.65] | 4 | 5-103973-4 | 5-103972-4 | 5-103971-4 | 5-103970-4 | 5-103969-4 | 5-103968-4 | 103648-4 |
| 6 | 2.390 [60.71] | .598 [15.19] | 4 | 5-103973-5 | 5-103972-5 | 5-103971-5 | 5-103970-5 | 5-103969-5 | 5-103968-5 | 103648-5 |
| 7 | 1.400 [35.56] | .698 [17.73] | 2 | 5-103973-6 | 5-103972-6 | 5-103971-6 | 5-103970-6 | 5-103969-6 | 5-103968-6 | 103648-6 |
| 8 | 1.600 [40.64] | .798 [20.27] | 2 | 5-103973-7 | 5-103972-7 | 5-103971-7 | 5-103970-7 | 5-103969-7 | 5-103968-7 | 103648-7 |
| 9 | 1.800 [45.72] | .898 [22.81] | 2 | 5-103973-8 | 5-103972-8 | 5-103971-8 | 5-103970-8 | 5-103969-8 | 5-103968-8 | 103648-8 |
| 10 | 2.000 [50.80] | .998 [23.35] | 2 | 5-103973-9 | 5-103972-9 | 5-103971-9 | 5-103970-9 | 5-103969-9 | 5-103968-9 | 103648-9 |
| 11 | 2.200 [55.88] | 1.098 [27.89] | 2 | 6-103973-0 | 6-103972-0 | 6-103971-0 | 6-103970-0 | 6-103969-0 | 6-103968-0 | 1-103648-0 |
| 12 | 2.400 [60.96] | 1.198 [30.43] | 2 | 6-103973-1 | 6-103972-1 | 6-103971-1 | 6-103970-1 | 6-103969-1 | 6-103968-1 | 1-103648-1 |

MTE Receptacle Assemblies—Individual Form with Guide Ribs, Single-Row, .100 [2.54] Centerline

| No. of Pos. | Dimensions B | Individual Receptacle Assembly 30-26 AWG [0.05-0.15mm ²] Wire | | | Individual Receptacle Assembly 26-22 AWG [0.12-0.3mm ²] Wire | | | Unloaded Housings |
|-------------|---------------|---|------------|------------|--|------------|------------|-------------------|
| | | Plating A | Plating B | Plating C | Plating A | Plating B | Plating C | |
| 13 | 1.298 [32.96] | 6-103901-2 | 6-103649-2 | 6-103650-2 | 6-103900-2 | 6-103651-2 | 6-103652-2 | 1-103648-2 |
| 14 | 1.398 [35.51] | 6-103901-3 | 6-103649-3 | 6-103650-3 | 6-103900-3 | 6-103651-3 | 6-103652-3 | 1-103648-3 |
| 15 | 1.498 [38.05] | 6-103901-4 | 6-103649-4 | 6-103650-4 | 6-103900-4 | 6-103651-4 | 6-103652-4 | 1-103648-4 |
| 16 | 1.598 [40.59] | 6-103901-5 | 6-103649-5 | 6-103650-5 | 6-103900-5 | 6-103651-5 | 6-103652-5 | 1-103648-5 |
| 17 | 1.698 [43.13] | 6-103901-6 | 6-103649-6 | 6-103650-6 | 6-103900-6 | 6-103651-6 | 6-103652-6 | 1-103648-6 |
| 18 | 1.798 [45.67] | 6-103901-7 | 6-103649-7 | 6-103650-7 | 6-103900-7 | 6-103651-7 | 6-103652-7 | 1-103648-7 |
| 19 | 1.898 [48.20] | 6-103901-8 | 6-103649-8 | 6-103650-8 | 6-103900-8 | 6-103651-8 | 6-103652-8 | 1-103648-8 |
| 20 | 1.998 [50.75] | 6-103901-9 | 6-103649-9 | 6-103650-9 | 6-103900-9 | 6-103651-9 | 6-103652-9 | 1-103648-9 |
| 21 | 2.098 [53.29] | 7-103901-0 | 7-103649-0 | 7-103650-0 | 7-103900-0 | 7-103651-0 | 7-103652-0 | 2-103648-0 |
| 22 | 2.198 [55.83] | 7-103901-1 | 7-103649-1 | 7-103650-1 | 7-103900-1 | 7-103651-1 | 7-103652-1 | 2-103648-1 |
| 23 | 2.298 [58.37] | 7-103901-2 | 7-103649-2 | 7-103650-2 | 7-103900-2 | 7-103651-2 | 7-103652-2 | 2-103648-2 |
| 24 | 2.398 [60.91] | 7-103901-3 | 7-103649-3 | 7-103650-3 | 7-103900-3 | 7-103651-3 | 7-103652-3 | 2-103648-3 |
| 25 | 2.498 [63.45] | 7-103901-4 | 7-103649-4 | 7-103650-4 | 7-103900-4 | 7-103651-4 | 7-103652-4 | 2-103648-4 |

- Notes:** 1. Receptacle assemblies are furnished with strip contacts partially inserted into housing—contacts latched into “preload” windows. Contacts are fully inserted into housings automatically when terminated with TE application machines, or manually when terminated with TE pistol grip hand tool.
 2. Use **Extraction/Lance Reset Tool No. 843477-1** to remove receptacle contacts.
 3. Keying plugs are available, see page 253.

Note: All part numbers are RoHS compliant.

MTE High Pressure Receptacle Assemblies—Plain, Single-Row, .100 [2.54] Centerline



Preassembled housings in strip form are available in positions 2 thru 12. For ease of handling, positions 2 thru 5 are recommended when using the TE Manual Pistol Grip Tool.

Material and Finish

Housing — Black thermoplastic, 94V-0 rated

Contacts — Phosphor Bronze, duplex plated .000030 [0.00076] gold on contact area, .000050 [0.00127] min. tin in crimp area, with entire contact underplated .000050 [0.00127] nickel

Note: Insulation displacement contacts accept an insulation diameter of .030 [0.76] min. to .054 [1.37] max. with an insulation wall thickness of .015 [0.38] max. Mating post length for preloaded housings is .200 [5.08] min., .250 [6.35] max.

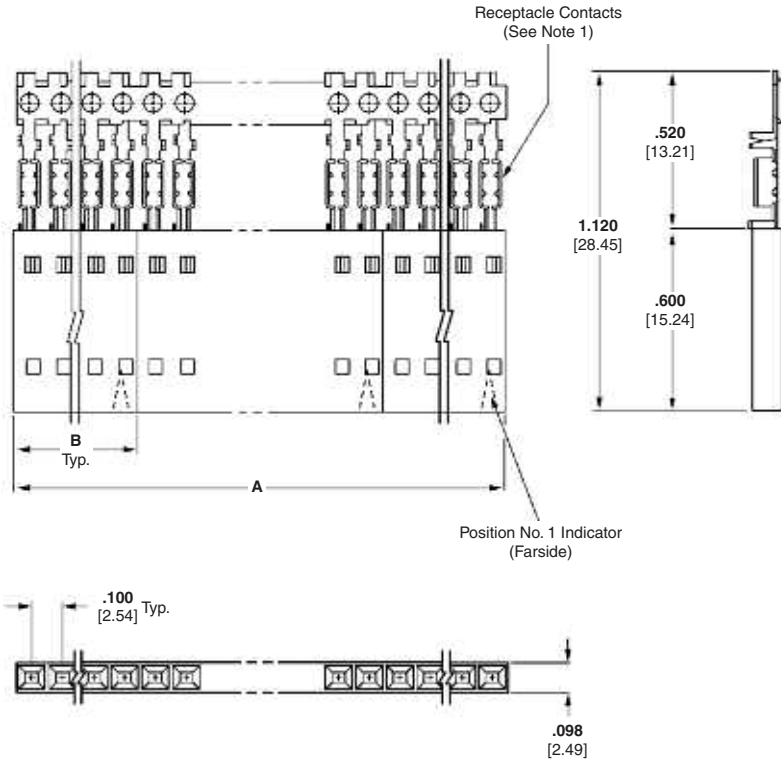

Related Product Data

Mateable AMPMODU Products

Breakaway Headers — pages 102-110, (with .230 mating length)

Reeled Breakaway Headers — pages 106, 107 (with .230 mating length)

Machine Applied Bandolier Posts — page 163

Application Tooling — page 273

Performance Specifications — page 225

Technical Documents — pages 277, 278)

Product Specification
108-25034

Application Specification
114-25026

| No. of Pos. | Dimensions | | Housings Quantities Per Strip Segment | Strip Form Receptacle Assembly | Strip Form Receptacle Assembly |
|-------------|---------------|---------------|---------------------------------------|---|---|
| | A | B | | 30-26 AWG [.05-.15mm ²] Wire | 26-22 AWG [.12-.30mm ²] Wire |
| 2 | 1.980 [50.29] | .198 [5.03] | 10 | 5-104438-1 | 5-104439-1 |
| 3 | 1.490 [37.85] | .298 [7.57] | 5 | 5-104438-2 | 5-104439-2 |
| 4 | 1.990 [50.55] | .398 [10.11] | 5 | 5-104438-3 | 5-104439-3 |
| 5 | 1.990 [50.55] | .498 [12.65] | 4 | 5-104438-4 | 5-104439-4 |
| 6 | 2.390 [60.71] | .598 [15.19] | 4 | 5-104438-5 | 5-104439-5 |
| 7 | 1.400 [35.56] | .698 [17.73] | 2 | 5-104438-6 | 5-104439-6 |
| 8 | 1.600 [40.64] | .798 [20.27] | 2 | 5-104438-7 | 5-104439-7 |
| 9 | 1.800 [45.72] | .898 [22.81] | 2 | 5-104438-8 | 5-104439-8 |
| 10 | 2.000 [50.80] | .998 [23.35] | 2 | 5-104438-9 | 5-104439-9 |
| 11 | 2.200 [55.88] | 1.098 [27.89] | 2 | 6-104438-0 | 6-104439-0 |
| 12 | 2.400 [60.96] | 1.198 [30.43] | 2 | 6-104438-1 | 6-104439-1 |

- Notes:**
1. Receptacle assemblies are furnished with strip contacts partially inserted into housing—contacts latched into “preload” windows. Contacts are fully inserted into housings automatically when terminated with TE application machines, or manually when terminated with TE pistol grip hand tool.
 2. High pressure receptacle contacts can be made available in other housing styles and position sizes. Contact your TE sales representative.

Note: All part numbers are RoHS compliant.

MTE High Pressure Receptacle Assemblies – Guide Ribs



Preassembled housings in strip form are available in positions 2 thru 12. For ease of handling, positions 2 thru 5 are recommended when using the TE Manual Pistol Grip Tool.

Material and Finish

Housing — Thermoplastic, black, 94V-0 rated

Contacts — Phosphor Bronze, duplex plated .000030 [0.00076] gold on contact area, .000050 [0.00127] min. tin on crimp area, with entire contact underplated .000050 [0.00127] nickel.

Related Product Data

Coupling Shrouds used with — Single-Row — page 240

Double-Row — page 241

Mateable AMPMODU Products (with Receptacle Assemblies Installed in Single-Row Coupling Shrouds) —

Pin Assemblies (Polarized/Latching) — pages 236, 237

Pin Assemblies with Guide Ribs (installed in Panel Mount Pin Shroud) — pages 238, 239, 242

Headers (Polarized/Latching) — pages 244-252

Mateable AMPMODU Products (with Receptacle Assemblies Installed in Double-Row Coupling Shrouds) —

Headers, Shrouded, Double-Row (.318 [8.08] mating post length, .150 [3.81] end dimension) — pages 119-121, 124, 125, 128, 129, 131-133

Application Tooling — page 273

Performance Specifications — page 225

Technical Documents — pages 277, 278

Product Specification
108-25034

Application Specification
114-25026

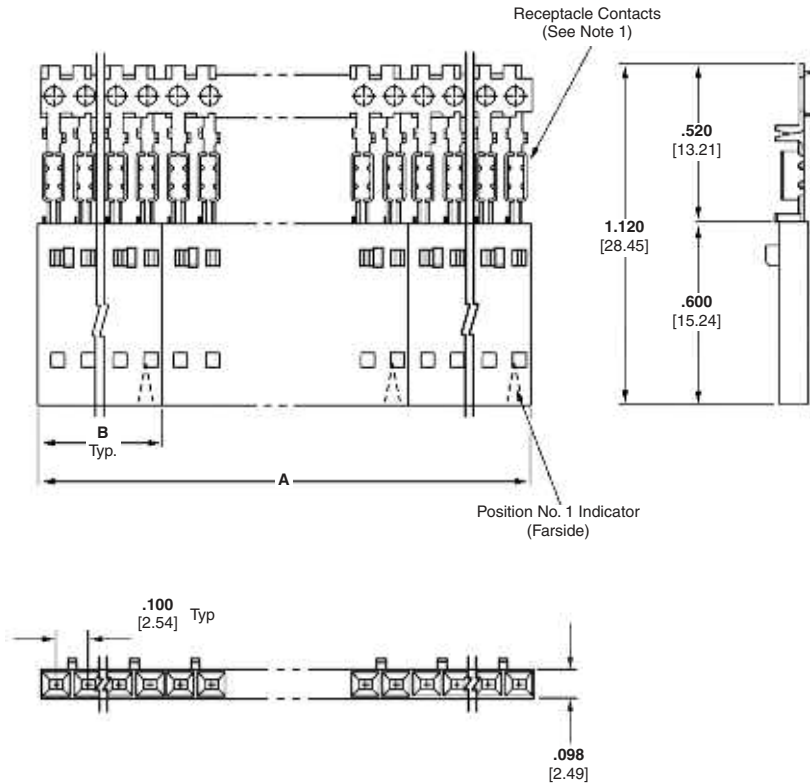

| No. of Pos. | Dimensions | | Housings Quantities Per Strip Segment | Strip Form Receptacle Assembly 30-26 AWG [.05-.15mm ²] Wire | Strip Form Receptacle Assembly 26-22 AWG [.12-.30mm ²] Wire |
|-------------|---------------|---------------|---------------------------------------|---|---|
| | A | B | | | |
| 2 | 1.980 [50.29] | .198 [5.03] | 10 | 5-147396-1 | 5-147030-3 |
| 3 | 1.490 [37.85] | .298 [7.57] | 5 | 5-147396-2 | 5-147030-4 |
| 4 | 1.990 [50.55] | .398 [10.11] | 5 | 5-147396-3 | 5-147030-1 |
| 5 | 1.990 [50.55] | .498 [12.65] | 4 | 5-147396-4 | 5-147030-2 |
| 6 | 2.390 [60.71] | .598 [15.19] | 4 | 5-147396-5 | 5-147030-5 |
| 7 | 1.400 [35.56] | .698 [17.73] | 2 | 5-147396-6 | 5-147030-6 |
| 8 | 1.600 [40.64] | .798 [20.27] | 2 | 5-147396-7 | 5-147030-7 |
| 9 | 1.800 [45.72] | .898 [22.81] | 2 | 5-147396-8 | 5-147030-8 |
| 10 | 2.000 [50.80] | .998 [23.35] | 2 | 5-147396-9 | 5-147030-9 |
| 11 | 2.200 [55.88] | 1.098 [27.89] | 2 | 6-147396-0 | 6-147030-0 |
| 12 | 2.400 [60.96] | 1.198 [30.43] | 2 | 6-147396-1 | 6-147030-1 |

Note: All part numbers are RoHS compliant.

MTE Pin Assemblies, Shrouded—Polarized/Latching, Single-Row, .100 [2.54] Centerline



Preassembled housings in strip form are available in positions 2 thru 12. For ease of handling, positions 2 thru 5 are recommended when using the TE Manual Pistol Grip Tool.

Material and Finish

Housing — Black thermoplastic, 94V-0 rated

Contacts — Phosphor Bronze, plated as follows:

Plating A — Duplex plated .000030 [0.00076] gold on contact area, .000050 [0.00127] min. tin in crimp area, with entire contact underplated .000050 [0.00127] nickel

Plating B — Duplex plated .000015 [0.00038] gold on contact area, .000050 [0.00127] min. tin in crimp area, with entire contact underplated .000050 [0.00127] nickel

Plating C — .000100 [0.00254] tin over .000050 [0.00127] nickel on entire contact

Note: Insulation displacement contacts accept an insulation diameter of .030 [0.76] min. to .054 [1.37] max. with an insulation wall thickness of .015 [0.38] max.

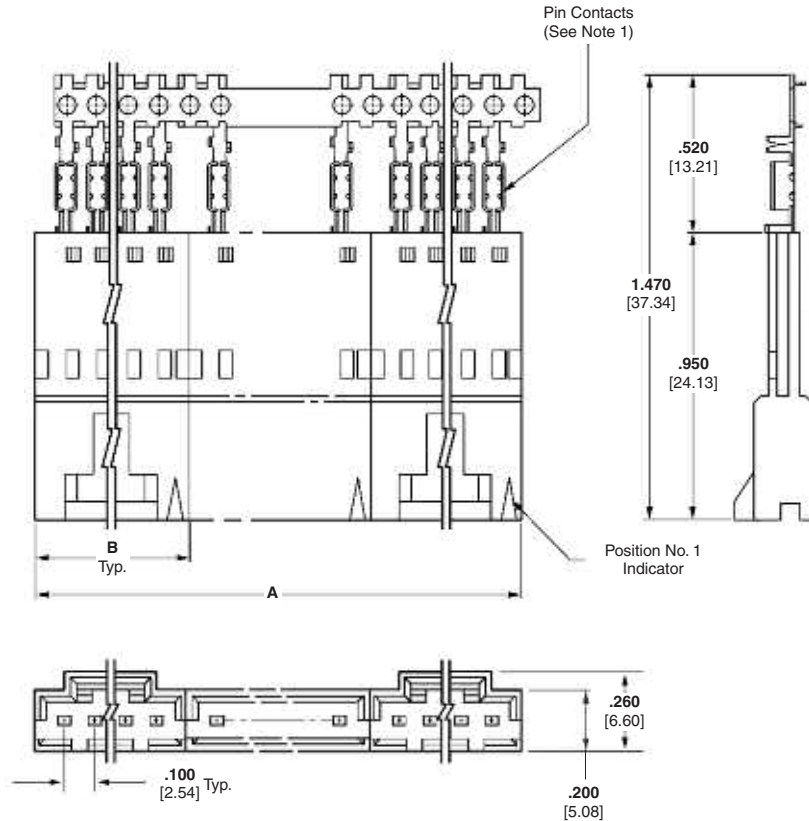

Related Product Data

Mateable AMPMODU Products —

Receptacle Assemblies (Polarized/Latching) — pages 230, 231

Receptacle Assemblies with Guide Ribs (installed in Single-Row Coupling Shroud) — pages 232, 233, 235, 240

Interchangeable Crimp Contacts — page 254

Application Tooling — page 273

Performance Specifications — page 225

Technical Documents — pages 277, 278

Product Specification
108-25034

Application Specification
114-25026

MTE Pin Assemblies, Shrouded—Strip Form Polarized/Latching, Single-Row, .100 [2.54] Centerline (Continued)

| No. of Pos. | Dimensions | | Housing Quantities Per Strip Segment | Strip Form Pin Assembly 30-26 AWG [0.05-0.15mm ²] Wire | | | Strip Form Pin Assembly 26-22 AWG [0.12-0.3mm ²] Wire | | | Unloaded Housings |
|-------------|---------------|---------------|--------------------------------------|--|------------|------------|---|------------|------------|-------------------|
| | A | B | | Plating A | Plating B | Plating C | Plating A | Plating B | Plating C | |
| 2 | 2.360 [59.94] | .295 [7.49] | 8 | 5-103949-1 | 5-103948-1 | 5-103947-1 | 5-103946-1 | 5-103945-1 | 5-103944-1 | 103653-1 |
| 3 | 1.980 [50.29] | .395 [10.03] | 5 | 5-103949-2 | 5-103948-2 | 5-103947-2 | 5-103946-2 | 5-103945-2 | 5-103944-2 | 103653-2 |
| 4 | 1.980 [50.29] | .495 [12.57] | 4 | 5-103949-3 | 5-103948-3 | 5-103947-3 | 5-103946-3 | 5-103945-3 | 5-103944-3 | 103653-3 |
| 5 | 2.380 [60.45] | .595 [15.11] | 4 | 5-103949-4 | 5-103948-4 | 5-103947-4 | 5-103946-4 | 5-103945-4 | 5-103944-4 | 103653-4 |
| 6 | 1.390 [35.31] | .695 [17.65] | 2 | 5-103949-5 | 5-103948-5 | 5-103947-5 | 5-103946-5 | 5-103945-5 | 5-103944-5 | 103653-5 |
| 7 | 2.390 [60.71] | .795 [20.19] | 3 | 5-103949-6 | 5-103948-6 | 5-103947-6 | 5-103946-6 | 5-103945-6 | 5-103944-6 | 103653-6 |
| 8 | 1.790 [45.47] | .895 [22.73] | 2 | 5-103949-7 | 5-103948-7 | 5-103947-7 | 5-103946-7 | 5-103945-7 | 5-103944-7 | 103653-7 |
| 9 | 1.990 [50.57] | .995 [25.27] | 2 | 5-103949-8 | 5-103948-8 | 5-103947-8 | 5-103946-8 | 5-103945-8 | 5-103944-8 | 103653-8 |
| 10 | 2.190 [55.63] | 1.095 [27.81] | 2 | 5-103949-9 | 5-103948-9 | 5-103947-9 | 5-103946-9 | 5-103945-9 | 5-103944-9 | 103653-9 |
| 11 | 2.390 [60.71] | 1.195 [30.35] | 2 | 6-103949-0 | 6-103948-0 | 6-103947-0 | 6-103946-0 | 6-103945-0 | 6-103944-0 | 1-103653-0 |
| 12 | 2.590 [65.79] | 1.295 [32.89] | 2 | 6-103949-1 | 6-103948-1 | 6-103947-1 | 6-103946-1 | 6-103945-1 | 6-103944-1 | 1-103653-1 |

MTE Pin Assemblies, Shrouded—Individual Form Polarized/Latching, Single-Row, .100 [2.54] Centerline

| No. of Pos. | Dimensions B | Individual Pin Assembly 30-26 AWG [0.05-0.15mm ²] Wire | | | Individual Pin Assembly 26-22 AWG [0.12-0.3mm ²] Wire | | | Unloaded Housings |
|-------------|---------------|--|------------|------------|---|------------|------------|-------------------|
| | | Plating A | Plating B | Plating C | Plating A | Plating B | Plating C | |
| 13 | 1.395 [35.43] | 6-103894-2 | 6-103658-2 | 6-103659-2 | 6-103893-2 | 6-103660-2 | 6-103661-2 | 1-103653-2 |
| 14 | 1.495 [37.97] | 6-103894-3 | 6-103658-3 | 6-103659-3 | 6-103893-3 | 6-103660-3 | 6-103661-3 | 1-103653-3 |
| 15 | 1.595 [40.51] | 6-103894-4 | 6-103658-4 | 6-103659-4 | 6-103893-4 | 6-103660-4 | 6-103661-4 | 1-103653-4 |
| 16 | 1.695 [43.05] | 6-103894-5 | 6-103658-5 | 6-103659-5 | 6-103893-5 | 6-103660-5 | 6-103661-5 | 1-103653-5 |
| 17 | 1.795 [45.59] | 6-103894-6 | 6-103658-6 | 6-103659-6 | 6-103893-6 | 6-103660-6 | 6-103661-6 | 1-103653-6 |
| 18 | 1.895 [48.13] | 6-103894-7 | 6-103658-7 | 6-103659-7 | 6-103893-7 | 6-103660-7 | 6-103661-7 | 1-103653-7 |
| 19 | 1.995 [50.67] | 6-103894-8 | 6-103658-8 | 6-103659-8 | 6-103893-8 | 6-103660-8 | 6-103661-8 | 1-103653-8 |
| 20 | 2.095 [53.21] | 6-103894-9 | 6-103658-9 | 6-103659-9 | 6-103893-9 | 6-103660-9 | 6-103661-9 | 1-103653-9 |
| 21 | 2.195 [55.75] | 7-103894-0 | 7-103658-0 | 7-103659-0 | 7-103893-0 | 7-103660-0 | 7-103661-0 | 2-103653-0 |
| 22 | 2.295 [58.29] | 7-103894-1 | 7-103658-1 | 7-103659-1 | 7-103893-1 | 7-103660-1 | 7-103661-1 | 2-103653-1 |
| 23 | 2.395 [60.83] | 7-103894-2 | 7-103658-2 | 7-103659-2 | 7-103893-2 | 7-103660-2 | 7-103661-2 | 2-103653-2 |
| 24 | 2.495 [63.37] | 7-103894-3 | 7-103658-3 | 7-103659-3 | 7-103893-3 | 7-103660-3 | 7-103661-3 | 2-103653-3 |
| 25 | 2.595 [65.91] | 7-103894-4 | 7-103658-4 | 7-103659-4 | 7-103893-4 | 7-103660-4 | 7-103661-4 | 2-103653-4 |

Notes: 1. Pin assemblies are furnished with strip contacts partially inserted into housing—contacts latched into “preload” windows. Contacts are fully inserted into housings automatically when terminated with TE application machines, or manually when terminated with TE pistol grip hand tool.
 2. Use **Extraction/Lance Reset Tool No. 843477-1** to remove pin contacts.

Note: All part numbers are RoHS compliant.

MTE Pin Assemblies—Guide Ribs, Single-Row, .100 [2.54] Centerline



Preassembled housings in strip form are available in positions 2 thru 12. For ease of handling, positions 2 thru 5 are recommended when using the TE Manual Pistol Grip Tool.

Material and Finish

Housing — Black thermoplastic, 94V-0 rated

Contacts — Phosphor Bronze, plated as follows:

Plating A — Duplex plated .000030 [0.00076] gold on contact area, .000050 [0.00127] min. tin in crimp area, with entire contact underplated .000050 [0.00127] nickel

Plating B — Duplex plated .000015 [0.00038] gold on contact area, .000050 [0.00127] min. tin in crimp area, with entire contact underplated .000050 [0.00127] nickel

Plating C — .000100 [0.00254] tin over .000050 [0.00127] nickel on entire contact

Note: Insulation displacement contacts accept an insulation diameter of .030 [0.76] min. to .054 [1.37] max. with an insulation wall thickness of .015 [0.38] max.

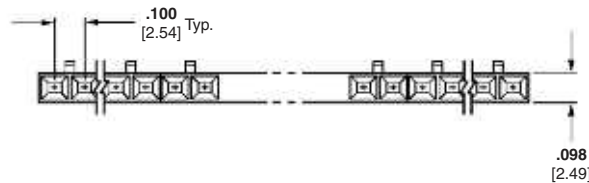
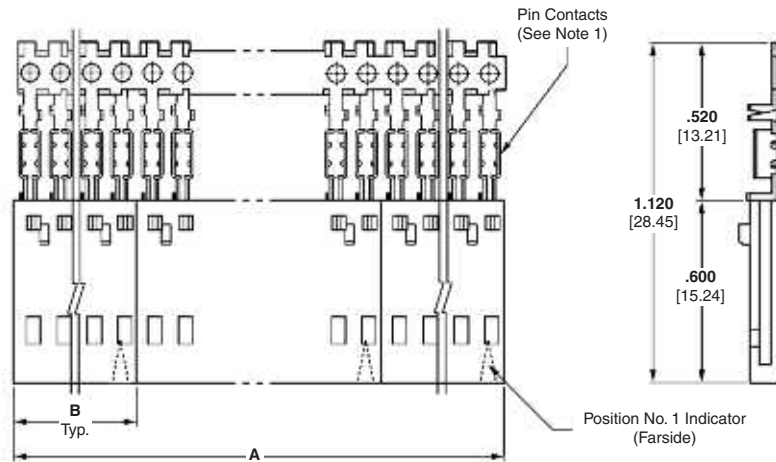

Related Product Data

Mateable AMPMODU MTE Products (with Pin Assembly Installed in Panel Mount Pin Shroud) — pages 242, 243

Receptacle Assemblies (Polarized/Latching) — pages 230, 231

Receptacle Assemblies with Guide Ribs (installed in Single Row Coupling Shroud) — pages 232, 233, 235, 240

Interchangeable Crimp Contacts — page 254

Application Tooling — page 273

Performance Specifications — page 225

Technical Documents — pages 277, 278

Product Specification
108-25034

Application Specification
114-25026

**MTE Pin Assemblies—Strip Form with Guide Ribs,
Single-Row, .100 [2.54] Centerline** (Continued)

| No. of Pos. | Dimensions | | Housing Quantities Per Strip Segment | Strip Form Pin Assembly 30-26 AWG [0.05-0.15mm ²] Wire | | | Strip Form Pin Assembly 26-22 AWG [0.12-0.3mm ²] Wire | | | Unloaded Housings |
|-------------|---------------|---------------|--------------------------------------|---|------------|------------|--|------------|------------|-------------------|
| | A | B | | Plating A | Plating B | Plating C | Plating A | Plating B | Plating C | |
| 2 | 1.980 [50.29] | 0.198 [5.03] | 10 | 5-103955-1 | 5-103954-1 | 5-103953-1 | 5-103952-1 | 5-103951-1 | 5-103950-1 | 104503-1 |
| 3 | 1.490 [37.85] | 0.298 [7.57] | 5 | 5-103955-2 | 5-103954-2 | 5-103953-2 | 5-103952-2 | 5-103951-2 | 5-103950-2 | 104503-2 |
| 4 | 1.990 [50.55] | 0.398 [10.11] | 5 | 5-103955-3 | 5-103954-3 | 5-103953-3 | 5-103952-3 | 5-103951-3 | 5-103950-3 | 104503-3 |
| 5 | 1.990 [50.55] | 0.498 [12.65] | 4 | 5-103955-4 | 5-103954-4 | 5-103953-4 | 5-103952-4 | 5-103951-4 | 5-103950-4 | 104503-4 |
| 6 | 2.390 [60.71] | 0.598 [15.19] | 4 | 5-103955-5 | 5-103954-5 | 5-103953-5 | 5-103952-5 | 5-103951-5 | 5-103950-5 | 104503-5 |
| 7 | 1.400 [35.56] | 0.698 [17.73] | 2 | 5-103955-6 | 5-103954-6 | 5-103953-6 | 5-103952-6 | 5-103951-6 | 5-103950-6 | 104503-6 |
| 8 | 1.600 [40.64] | 0.798 [20.27] | 2 | 5-103955-7 | 5-103954-7 | 5-103953-7 | 5-103952-7 | 5-103951-7 | 5-103950-7 | 104503-7 |
| 9 | 1.800 [45.72] | 0.898 [22.81] | 2 | 5-103955-8 | 5-103954-8 | 5-103953-8 | 5-103952-8 | 5-103951-8 | 5-103950-8 | 104503-8 |
| 10 | 2.000 [50.80] | 0.998 [25.35] | 2 | 5-103955-9 | 5-103954-9 | 5-103953-9 | 5-103952-9 | 5-103951-9 | 5-103950-9 | 104503-9 |
| 11 | 2.200 [55.88] | 1.098 [27.89] | 2 | 6-103955-0 | 6-103954-0 | 6-103953-0 | 6-103952-0 | 6-103951-0 | 6-103950-0 | 1-104503-0 |
| 12 | 2.400 [60.96] | 1.198 [30.43] | 2 | 6-103955-1 | 6-103954-1 | 6-103953-1 | 6-103952-1 | 6-103951-1 | 6-103950-1 | 1-104503-1 |

**MTE Pin Assemblies—Individual Form with Guide Ribs,
Single-Row, .100 [2.54] Centerline**

| No. of Pos. | Dimensions B | Individual Pin Assembly 30-26 AWG [0.05-0.15mm ²] Wire | | | Individual Pin Assembly 26-22 AWG [0.12-0.3mm ²] Wire | | | Unloaded Housings |
|-------------|---------------|---|------------|------------|--|------------|------------|-------------------|
| | | Plating A | Plating B | Plating C | Plating A | Plating B | Plating C | |
| 13 | 1.398 [35.51] | 6-103896-2 | 6-103657-2 | 6-103656-2 | 6-103895-2 | 6-103655-2 | 6-103654-2 | 1-104503-2 |
| 14 | 1.498 [38.05] | 6-103896-3 | 6-103657-3 | 6-103656-3 | 6-103895-3 | 6-103655-3 | 6-103654-3 | 1-104503-3 |
| 15 | 1.598 [40.59] | 6-103896-4 | 6-103657-4 | 6-103656-4 | 6-103895-4 | 6-103655-4 | 6-103654-4 | 1-104503-4 |
| 16 | 1.698 [43.13] | 6-103896-5 | 6-103657-5 | 6-103656-5 | 6-103895-5 | 6-103655-5 | 6-103654-5 | 1-104503-5 |
| 17 | 1.798 [45.67] | 6-103896-6 | 6-103657-6 | 6-103656-6 | 6-103895-6 | 6-103655-6 | 6-103654-6 | 1-104503-6 |
| 18 | 1.898 [48.20] | 6-103896-7 | 6-103657-7 | 6-103656-7 | 6-103895-7 | 6-103655-7 | 6-103654-7 | 1-104503-7 |
| 19 | 1.998 [50.75] | 6-103896-8 | 6-103657-8 | 6-103656-8 | 6-103895-8 | 6-103655-8 | 6-103654-8 | 1-104503-8 |
| 20 | 2.098 [53.29] | 6-103896-9 | 6-103657-9 | 6-103656-9 | 6-103895-9 | 6-103655-9 | 6-103654-9 | 1-104503-9 |
| 21 | 2.198 [55.83] | 7-103896-0 | 7-103657-0 | 7-103656-0 | 7-103895-0 | 7-103655-0 | 7-103654-0 | 2-104503-0 |
| 22 | 2.298 [58.37] | 7-103896-1 | 7-103657-1 | 7-103656-1 | 7-103895-1 | 7-103655-1 | 7-103654-1 | 2-104503-1 |
| 23 | 2.398 [60.91] | 7-103896-2 | 7-103657-2 | 7-103656-2 | 7-103895-2 | 7-103655-2 | 7-103654-2 | 2-104503-2 |
| 24 | 2.498 [63.45] | 7-103896-3 | 7-103657-3 | 7-103656-3 | 7-103895-3 | 7-103655-3 | 7-103654-3 | 2-104503-3 |
| 25 | 2.598 [65.99] | 7-103896-4 | 7-103657-4 | 7-103656-4 | 7-103895-4 | 7-103655-4 | 7-103654-4 | 2-104503-4 |

- Notes:** 1. Pin assemblies are furnished with strip contacts partially inserted into housing—contacts latched into “preload” windows. Contacts are fully inserted into housings automatically when terminated with TE application machines, or manually when terminated with TE pistol grip hand tool.
2. Use **Extraction/Lance Reset Tool No. 843477-1** to remove pin contacts.

Note: All part numbers are RoHS compliant.

Coupling Shrouds for MTE Receptacle Assemblies with Guide Ribs

Single-Row

Material

Black thermoplastic, 94V-0 rated

Technical Documents —
pages 277, 278

Product Specification
108-25034

Application Specification
114-25026

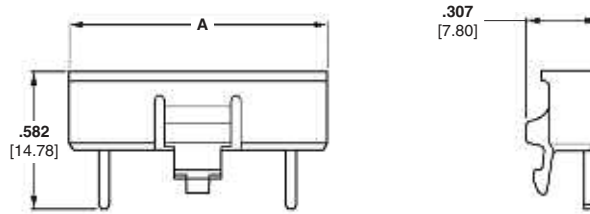

| No. of Pos. | Dimension A | Single-Row Coupling Shroud |
|-------------|---------------|----------------------------|
| 4 | .485 [12.32] | 103680-1 |
| 5 | .585 [14.86] | 103680-2 |
| 6 | .685 [17.40] | 103680-3 |
| 7 | .785 [19.94] | 103680-4 |
| 8 | .885 [22.48] | 103680-5 |
| 9 | .985 [25.02] | 103680-6 |
| 10 | 1.085 [27.56] | 103680-7 |
| 11 | 1.185 [30.10] | 103680-8 |
| 12 | 1.285 [32.64] | 103680-9 |
| 13 | 1.385 [35.18] | 1-103680-0 |
| 14 | 1.485 [37.72] | 1-103680-1 |

| No. of Pos. | Dimension A | Single-Row Coupling Shroud |
|-------------|---------------|----------------------------|
| 15 | 1.585 [40.26] | 1-103680-2 |
| 16 | 1.685 [42.80] | 1-103680-3 |
| 17 | 1.785 [45.34] | 1-103680-4 |
| 18 | 1.885 [47.88] | 1-103680-5 |
| 19 | 1.985 [50.42] | 1-103680-6 |
| 20 | 2.085 [52.96] | 1-103680-7 |
| 21 | 2.185 [55.50] | 1-103680-8 |
| 22 | 2.285 [58.04] | 1-103680-9 |
| 23 | 2.385 [60.58] | 2-103680-0 |
| 24 | 2.485 [63.12] | 2-103680-1 |
| 25 | 2.585 [65.66] | 2-103680-2 |

MTE Coupling Shrouds

5

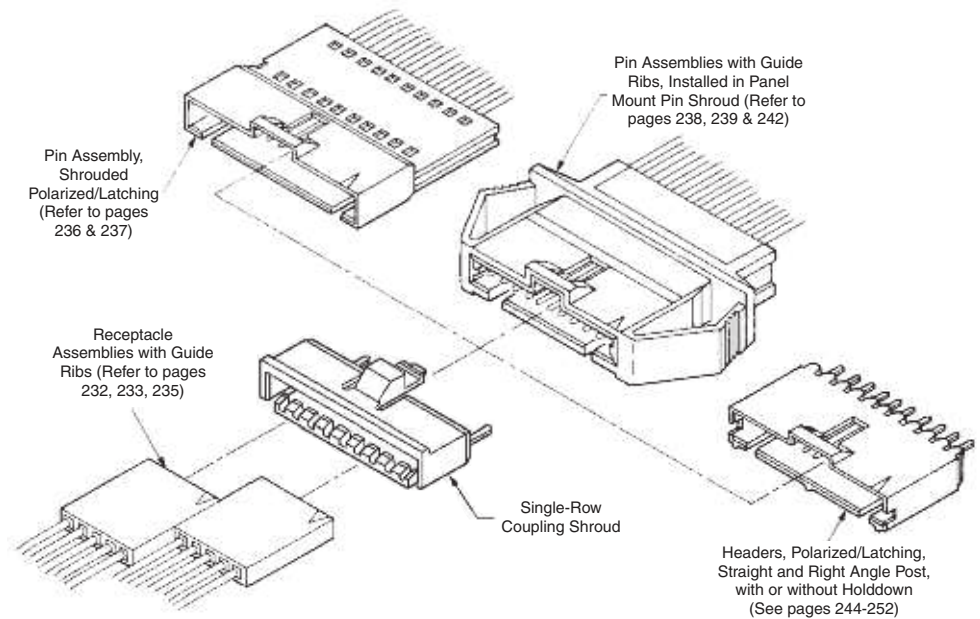

Typical Application of Single-Row Coupling Shroud and Mating AMPMODU MTE Products

Note: All part numbers are RoHS compliant.

Coupling Shrouds for MTE Receptacle Assemblies with Guide Ribs (Continued)

Double-Row

Material

Black thermoplastic, 94V-0 rated

Technical Documents —
pages 277, 278

Product Specification
108-25034

Application Specification
114-25026

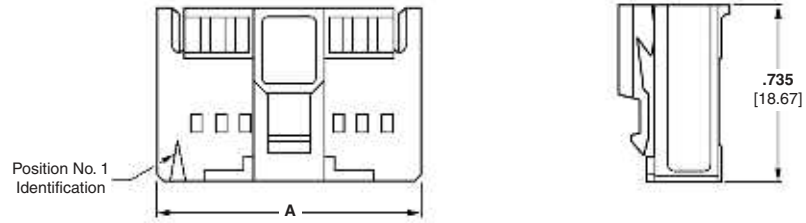

| No. of Pos. | Dimension A | Double-Row Coupling Shroud |
|-------------|---------------|----------------------------|
| 8 | .585 [14.86] | 103681-1 |
| 10 | .685 [17.40] | 103681-2 |
| 12 | .785 [19.94] | 103681-3 |
| 14 | .885 [22.48] | 103681-4 |
| 16 | .985 [25.02] | 103681-5 |
| 18 | 1.085 [27.56] | 104500-1 |
| 20 | 1.185 [30.10] | 104500-2 |
| 22 | 1.285 [32.64] | 104500-3 |
| 24 | 1.385 [35.18] | 104500-4 |
| 26 | 1.485 [37.72] | 104500-5 |
| 28 | 1.585 [40.26] | 104500-6 |
| 30 | 1.685 [42.80] | 104500-7 |
| 32 | 1.785 [45.34] | 104500-8 |
| 34 | 1.885 [47.88] | 104500-9 |
| 40 | 2.185 [55.50] | 1-104500-0 |
| 50 | 2.685 [68.20] | 1-104500-1 |

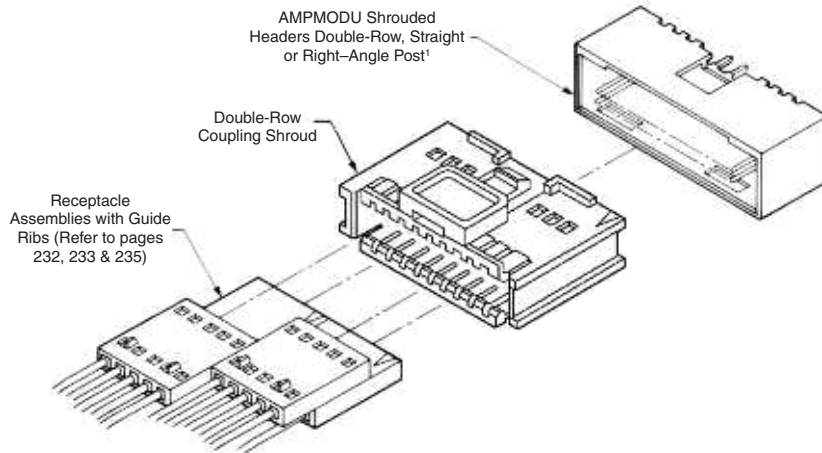

¹Mating AMPMODU Double-Row Shrouded Headers must have .318 [8.08] mating post length and .150 [3.81] dimension from centerline of last post to inside of end shroud wall.

Typical Application of Double-Row Coupling Shroud and Mating AMPMODU Products

Note: All part numbers are RoHS compliant.

Panel Mount Pin Shrouds for MTE Pin Assemblies with Guide Ribs, Single-Row

Material

Black thermoplastic, 94V-0 rated

Technical Documents —
pages 277, 278

Product Specification
108-25034

Application Specification
114-25026

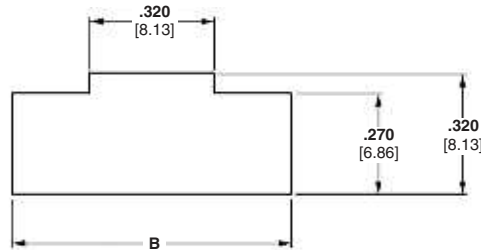
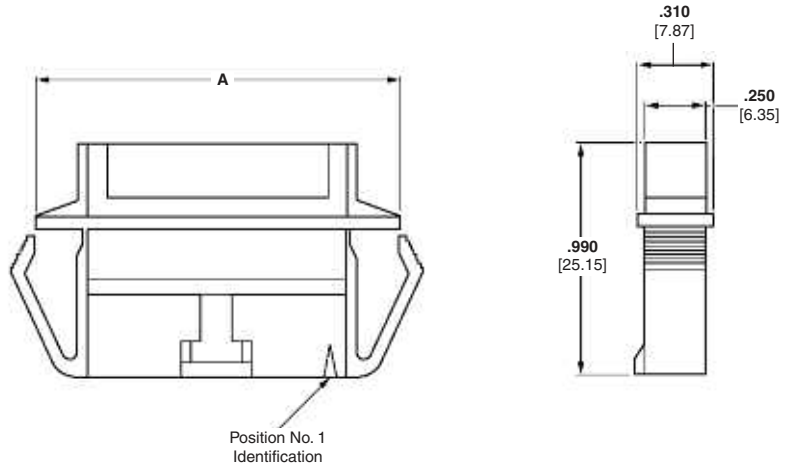

| No. of Pos. | Dimensions | | Panel Mount Pin Shroud |
|-------------|---------------|---------------|------------------------|
| | A | B | |
| 2 | .735 [18.67] | .625 [15.88] | 103682-1 |
| 3 | .835 [21.21] | .725 [18.42] | 103682-2 |
| 4 | .935 [23.75] | .825 [20.96] | 103682-3 |
| 5 | 1.035 [26.29] | .925 [23.50] | 103682-4 |
| 6 | 1.135 [28.83] | 1.025 [26.04] | 103682-5 |
| 7 | 1.235 [31.37] | 1.125 [28.58] | 103682-6 |
| 8 | 1.335 [33.91] | 1.225 [31.12] | 103682-7 |
| 9 | 1.435 [36.45] | 1.325 [33.66] | 103682-8 |
| 10 | 1.535 [38.99] | 1.425 [36.20] | 103682-9 |
| 11 | 1.635 [41.53] | 1.525 [38.74] | 1-103682-0 |
| 12 | 1.735 [44.07] | 1.625 [41.28] | 1-103682-1 |
| 13 | 1.835 [46.61] | 1.725 [43.82] | 1-103682-2 |

| No. of Pos. | Dimensions | | Panel Mount Pin Shroud |
|-------------|---------------|---------------|------------------------|
| | A | B | |
| 14 | 1.935 [49.15] | 1.825 [46.36] | 1-103682-3 |
| 15 | 2.035 [51.69] | 1.925 [48.90] | 1-103682-4 |
| 16 | 2.135 [54.23] | 2.025 [51.44] | 1-103682-5 |
| 17 | 2.235 [56.77] | 2.125 [53.98] | 1-103682-6 |
| 18 | 2.335 [59.31] | 2.225 [56.52] | 1-103682-7 |
| 19 | 2.435 [61.85] | 2.325 [59.06] | 1-103682-8 |
| 20 | 2.535 [64.39] | 2.425 [61.60] | 1-103682-9 |
| 21 | 2.635 [66.93] | 2.525 [64.14] | 2-103682-0 |
| 22 | 2.735 [69.47] | 2.625 [66.68] | 2-103682-1 |
| 23 | 2.835 [72.01] | 2.725 [69.22] | 2-103682-2 |
| 24 | 2.935 [74.55] | 2.825 [71.76] | 2-103682-3 |
| 25 | 3.035 [77.09] | 2.925 [74.30] | 2-103682-4 |

Note: All part numbers are RoHS compliant.

Panel Mount Pin Shrouds for MTE Pin Assemblies with Guide Ribs, Single-Row (Continued)

Material

Black thermoplastic, 94V-0 rated

Technical Documents —
pages 277, 278

Product Specification
108-25034

Application Specification
114-25026

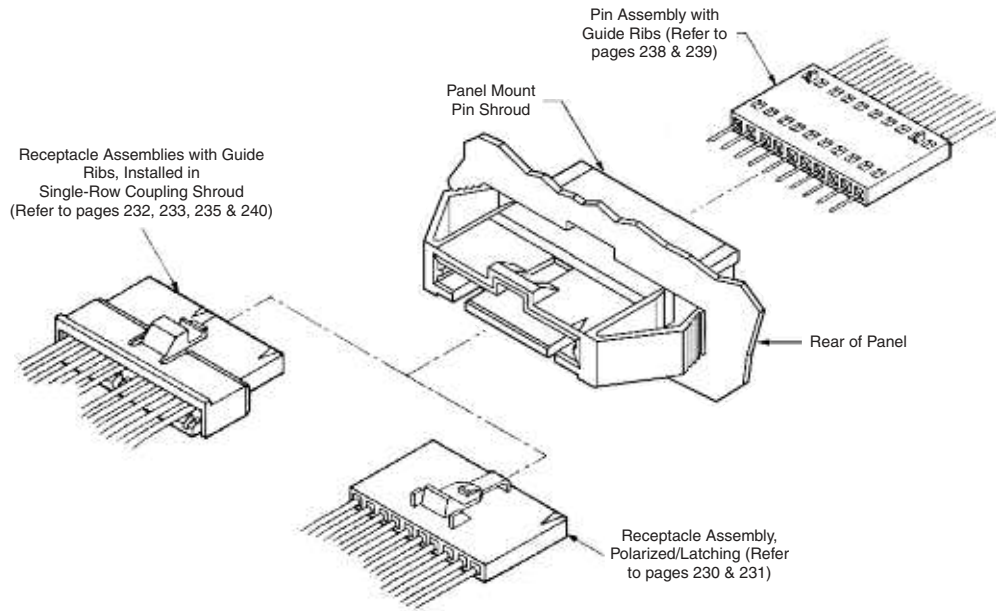

Typical Application of Panel Mount Pin Shroud and Mating AMPMODU Products

MTE Headers, Shrouded Polarized/Latching, Single-Row .100 [2.54] Centerline

.025 [0.64] Square Straight Post (With or Without Swaged Tail)

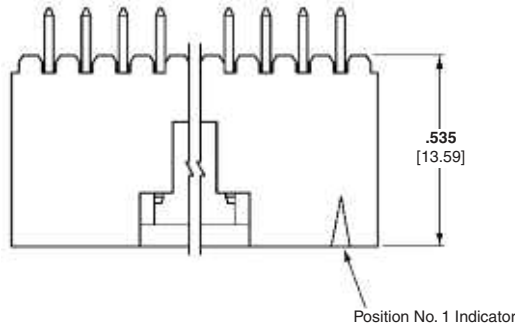

Swaged Retention Tail (See Note)

Material and Finish

Housing — Black thermoplastic, 94V-0 rated

Posts — Brass, plated as follows:

Plating A — Duplex plated .000030 [0.00076] gold on contact area, .000100 [0.00254] min. tin on solder area, with entire post underplated .000050 [0.00127] nickel

Plating B — Duplex plated .000015 [0.00038] gold on contact area, .000100 [0.00254] min. tin on solder area, with entire post underplated .000050 [0.00127] nickel

Plating C — .000100 [0.00254] tin over .000050 [0.00127] nickel on entire post

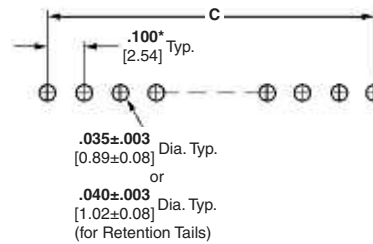
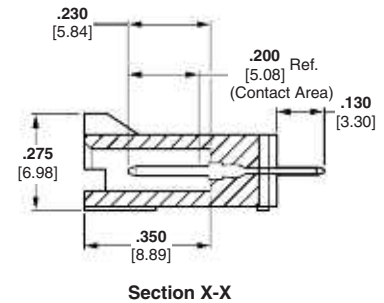
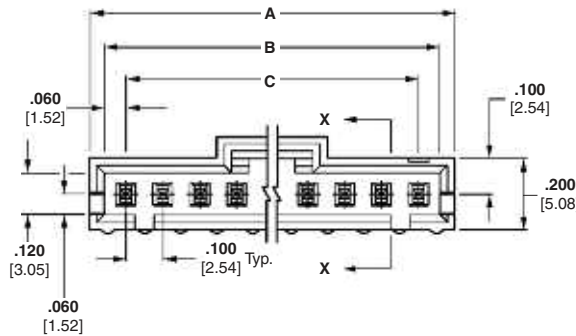

Recommended PC Board Hole Layout

*±.003 [±0.08]; tolerances not to accumulate within one connector pattern.

Note: Swaged retention tails are provided in a minimum of two locations per header.

Related Product Data

Mateable AMPMODU MTE Products —

Receptacle Assemblies (Polarized/Latching) — pages 230, 231

Receptacle Assemblies with Guide Ribs (installed in Single-Row Coupling Shroud) — pages 232, 233, 235, 240

Technical Documents — pages 277, 278

Product Specification
108-25034

Application Specification
114-25026

**MTE Headers, Shrouded Polarized/Latching,
Single-Row .100 [2.54] Centerline** (Continued)

| No. of Pos. | Dimensions | | | Polarized/Latching Header With Swage | | | Polarized/Latching Header Without Swage | | |
|-------------|---------------|---------------|---------------|--------------------------------------|------------|------------|---|------------|------------|
| | A | B | C | Plating A | Plating B | Plating C | Plating A | Plating B | Plating C |
| 2 | .300 [7.62] | .220 [5.59] | .100 [2.54] | 5-103908-1 | 5-104362-1 | 5-103669-1 | 5-103735-1 | 5-104363-1 | 5-103639-1 |
| 3 | .400 [10.16] | .320 [8.13] | .200 [5.08] | 5-103908-2 | 5-104362-2 | 5-103669-2 | 5-103735-2 | 5-104363-2 | 5-103639-2 |
| 4 | .500 [12.70] | .420 [10.67] | .300 [7.62] | 5-103908-3 | 5-104362-3 | 5-103669-3 | 5-103735-3 | 5-104363-3 | 5-103639-3 |
| 5 | .600 [15.24] | .520 [13.21] | .400 [10.16] | 5-103908-4 | 5-104362-4 | 5-103669-4 | 5-103735-4 | 5-104363-4 | 5-103639-4 |
| 6 | .700 [17.78] | .620 [15.75] | .500 [12.70] | 5-103908-5 | 5-104362-5 | 5-103669-5 | 5-103735-5 | 5-104363-5 | 5-103639-5 |
| 7 | .800 [20.32] | .720 [18.29] | .600 [15.24] | 5-103908-6 | 5-104362-6 | 5-103669-6 | 5-103735-6 | 5-104363-6 | 5-103639-6 |
| 8 | .900 [22.86] | .820 [20.83] | .700 [17.78] | 5-103908-7 | 5-104362-7 | 5-103669-7 | 5-103735-7 | 5-104363-7 | 5-103639-7 |
| 9 | 1.000 [25.40] | .920 [23.37] | .800 [20.32] | 5-103908-8 | 5-104362-8 | 5-103669-8 | 5-103735-8 | 5-104363-8 | 5-103639-8 |
| 10 | 1.100 [27.94] | 1.020 [25.91] | .900 [22.86] | 5-103908-9 | 5-104362-9 | 5-103669-9 | 5-103735-9 | 5-104363-9 | 5-103639-9 |
| 11 | 1.200 [30.48] | 1.120 [28.45] | 1.000 [25.40] | 6-103908-0 | 6-104362-0 | 6-103669-0 | 6-103735-0 | 6-104363-0 | 6-103639-0 |
| 12 | 1.300 [33.02] | 1.220 [30.99] | 1.100 [27.94] | 6-103908-1 | 6-104362-1 | 6-103669-1 | 6-103735-1 | 6-104363-1 | 6-103639-1 |
| 13 | 1.400 [35.56] | 1.320 [33.53] | 1.200 [30.48] | 6-103908-2 | 6-104909-2 | 6-103669-2 | 6-103735-2 | 6-104910-2 | 6-103639-2 |
| 14 | 1.500 [38.10] | 1.420 [36.07] | 1.300 [33.02] | 6-103908-3 | 6-104909-3 | 6-103669-3 | 6-103735-3 | 6-104910-3 | 6-103639-3 |
| 15 | 1.600 [40.64] | 1.520 [38.61] | 1.400 [35.56] | 6-103908-4 | 6-104909-4 | 6-103669-4 | 6-103735-4 | 6-104910-4 | 6-103639-4 |
| 16 | 1.700 [43.18] | 1.620 [41.15] | 1.500 [38.10] | 6-103908-5 | 6-104909-5 | 6-103669-5 | 6-103735-5 | 6-104910-5 | 6-103639-5 |
| 17 | 1.800 [45.72] | 1.720 [43.69] | 1.600 [40.64] | 6-103908-6 | 6-104909-6 | 6-103669-6 | 6-103735-6 | 6-104910-6 | 6-103639-6 |
| 18 | 1.900 [48.26] | 1.820 [46.23] | 1.700 [43.18] | 6-103908-7 | 6-104909-7 | 6-103669-7 | 6-103735-7 | 6-104910-7 | 6-103639-7 |
| 19 | 2.000 [50.80] | 1.920 [48.77] | 1.800 [45.72] | 6-103908-8 | 6-104909-8 | 6-103669-8 | 6-103735-8 | 6-104910-8 | 6-103639-8 |
| 20 | 2.100 [53.34] | 2.020 [51.31] | 1.900 [48.26] | 6-103908-9 | 6-104909-9 | 6-103669-9 | 6-103735-9 | 6-104910-9 | 6-103639-9 |
| 21 | 2.200 [55.88] | 2.120 [53.85] | 2.000 [50.80] | 7-103908-0 | 7-104909-0 | 7-103669-0 | 7-103735-0 | 7-104910-0 | 7-103639-0 |
| 22 | 2.300 [58.42] | 2.220 [56.39] | 2.100 [53.34] | 7-103908-1 | 7-104909-1 | 7-103669-1 | 7-103735-1 | 7-104910-1 | 7-103639-1 |
| 23 | 2.400 [60.96] | 2.320 [58.93] | 2.200 [55.88] | 7-103908-2 | 7-104909-2 | 7-103669-2 | 7-103735-2 | 7-104910-2 | 7-103639-2 |
| 24 | 2.500 [63.50] | 2.420 [61.47] | 2.300 [58.42] | 7-103908-3 | 7-104909-3 | 7-103669-3 | 7-103735-3 | 7-104910-3 | 7-103639-3 |
| 25 | 2.600 [66.04] | 2.520 [64.01] | 2.400 [60.96] | 7-103908-4 | 7-104909-4 | 7-103669-4 | 7-103735-4 | 7-104910-4 | 7-103639-4 |

Notes: 1. Selectively loaded headers are available, consult TE.
2. Use Keying Tool No. 91417-1 to remove post for keying.

Note: All part numbers are RoHS compliant.

MTE Headers, Shrouded Latching, Single-Row .100 [2.54] Centerline

.025 [0.64] Square Right-Angle Post



Material and Finish

Housing — Black thermoplastic, 94V-0 rated

Posts — Brass, plated as follows:

Plating A — Duplex plated .000030 [0.00076] gold on contact area, .000100 [0.00254] min. tin on solder area, with entire post underplated .000050 [0.00127] nickel

Plating B — Duplex plated .000015 [0.00038] gold on contact area, .000100 [0.00254] min. tin on solder area, with entire post underplated .000050 [0.00127] nickel

Plating C — .000100 [0.00254] tin over .000050 [0.00127] nickel on entire post

With Holddown

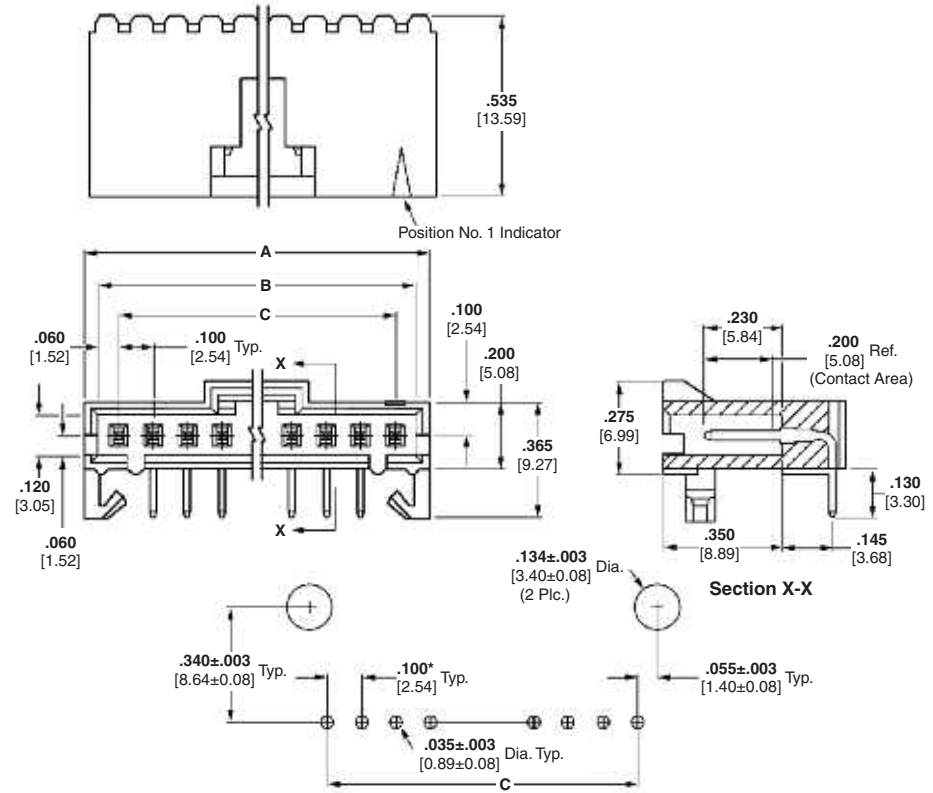

Recommended PC Board Hole Layout
(PC board thickness (for Holddown Feature) is .062±.008 [1.57±0.20])
*±.003 [±0.08]; tolerance not to accumulate within one connector pattern.

Without Holddown

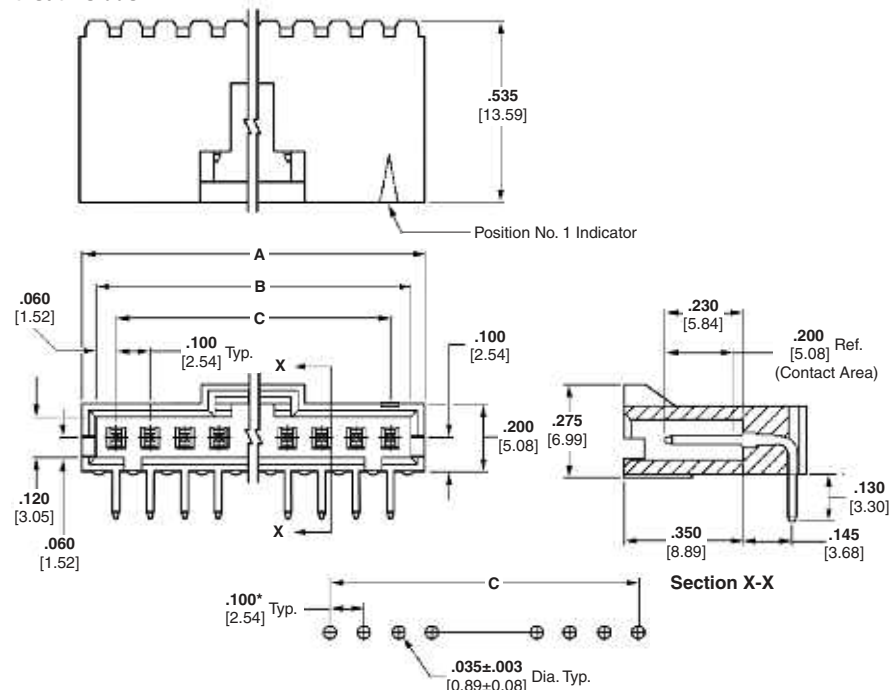

Recommended PC Board Hole Layout
*±.003 [±0.08]; tolerance not to accumulate within one connector pattern.

Related Product Data

Mateable AMPMODU MTE Products —

Receptacle Assemblies (Latching) — pages 230, 231
Receptacle Assemblies with Guide Ribs (installed in Single-Row Coupling Shroud) — pages 232, 233, 235, 240

Technical Documents — pages 277, 278

Product Specification
108-25034

Application Specification
114-25026

MTE Headers, Shrouded Latching, Single-Row .100 [2.54] Centerline (Continued)

| No. of Pos. | Dimensions | | | Latching Header With Hold Down | | | Latching Header Without Hold Down | | |
|-------------|---------------|---------------|---------------|--------------------------------|------------|------------|-----------------------------------|------------|------------|
| | A | B | C | Plating A | Plating B | Plating C | Plating A | Plating B | Plating C |
| 2 | .300 [7.62] | .220 [5.59] | .100 [2.54] | 5-103904-1 | 5-103673-1 | 5-103672-1 | 5-104935-5 | 5-103635-1 | 5-103634-1 |
| 3 | .400 [10.16] | .320 [8.13] | .200 [5.08] | 5-103904-2 | 5-103673-2 | 5-103672-2 | 5-104935-3 | 5-103635-2 | 5-103634-2 |
| 4 | .500 [12.70] | .420 [10.67] | .300 [7.62] | 5-103904-3 | 5-103673-3 | 5-103672-3 | 5-104935-1 | 5-103635-3 | 5-103634-3 |
| 5 | .600 [15.24] | .520 [13.21] | .400 [10.16] | 5-103904-4 | 5-103673-4 | 5-103672-4 | 5-104935-6 | 5-103635-4 | 5-103634-4 |
| 6 | .700 [17.78] | .620 [15.75] | .500 [12.70] | 5-103904-5 | 5-103673-5 | 5-103672-5 | 5-104935-7 | 5-103635-5 | 5-103634-5 |
| 7 | .800 [20.32] | .720 [18.29] | .600 [15.24] | 5-103904-6 | 5-103673-6 | 5-103672-6 | 5-104935-8 | 5-103635-6 | 5-103634-6 |
| 8 | .900 [22.86] | .820 [20.83] | .700 [17.78] | 5-103904-7 | 5-103673-7 | 5-103672-7 | 5-104935-2 | 5-103635-7 | 5-103634-7 |
| 9 | 1.000 [25.40] | .920 [23.37] | .800 [20.32] | 5-103904-8 | 5-103673-8 | 5-103672-8 | 5-104935-9 | 5-103635-8 | 5-103634-8 |
| 10 | 1.100 [27.94] | 1.020 [25.91] | .900 [22.86] | 5-103904-9 | 5-103673-9 | 5-103672-9 | 6-104935-0 | 5-103635-9 | 5-103634-9 |
| 11 | 1.200 [30.48] | 1.120 [28.45] | 1.000 [25.40] | 6-103904-0 | 6-103673-0 | 6-103672-0 | 6-104935-1 | 6-103635-0 | 6-103634-0 |
| 12 | 1.300 [33.02] | 1.220 [30.99] | 1.100 [27.94] | 6-103904-1 | 6-103673-1 | 6-103672-1 | 5-104935-4 | 6-103635-1 | 6-103634-1 |
| 13 | 1.400 [35.56] | 1.320 [33.53] | 1.200 [30.48] | 6-103904-2 | 6-103673-2 | 6-103672-2 | 6-104935-2 | 6-103635-2 | 6-103634-2 |
| 14 | 1.500 [38.10] | 1.420 [36.07] | 1.300 [33.02] | 6-103904-3 | 6-103673-3 | 6-103672-3 | 6-104935-3 | 6-103635-3 | 6-103634-3 |
| 15 | 1.600 [40.64] | 1.520 [38.61] | 1.400 [35.56] | 6-103904-4 | 6-103673-4 | 6-103672-4 | 6-104935-4 | 6-103635-4 | 6-103634-4 |
| 16 | 1.700 [43.18] | 1.620 [41.15] | 1.500 [38.10] | 6-103904-5 | 6-103673-5 | 6-103672-5 | 6-104935-5 | 6-103635-5 | 6-103634-5 |
| 17 | 1.800 [45.72] | 1.720 [43.69] | 1.600 [40.64] | 6-103904-6 | 6-103673-6 | 6-103672-6 | 6-104935-6 | 6-103635-6 | 6-103634-6 |
| 18 | 1.900 [48.26] | 1.820 [46.23] | 1.700 [43.18] | 6-103904-7 | 6-103673-7 | 6-103672-7 | 6-104935-7 | 6-103635-7 | 6-103634-7 |
| 19 | 2.000 [50.80] | 1.920 [48.77] | 1.800 [45.72] | 6-103904-8 | 6-103673-8 | 6-103672-8 | 6-104935-8 | 6-103635-8 | 6-103634-8 |
| 20 | 2.100 [53.34] | 2.020 [51.31] | 1.900 [48.26] | 6-103904-9 | 6-103673-9 | 6-103672-9 | 6-104935-9 | 6-103635-9 | 6-103634-9 |
| 21 | 2.200 [55.88] | 2.120 [53.85] | 2.000 [50.80] | 7-103904-0 | 7-103673-0 | 7-103672-0 | 7-104935-0 | 7-103635-0 | 7-103634-0 |
| 22 | 2.300 [58.42] | 2.220 [56.39] | 2.100 [53.34] | 7-103904-1 | 7-103673-1 | 7-103672-1 | 7-104935-1 | 7-103635-1 | 7-103634-1 |
| 23 | 2.400 [60.96] | 2.320 [58.93] | 2.200 [55.88] | 7-103904-2 | 7-103673-2 | 7-103672-2 | 7-104935-2 | 7-103635-2 | 7-103634-2 |
| 24 | 2.500 [63.50] | 2.420 [61.47] | 2.300 [58.42] | 7-103904-3 | 7-103673-3 | 7-103672-3 | 7-104935-3 | 7-103635-3 | 7-103634-3 |
| 25 | 2.600 [66.04] | 2.520 [64.01] | 2.400 [60.96] | 7-103904-4 | 7-103673-4 | 7-103672-4 | 7-104935-4 | 7-103635-4 | 7-103634-4 |

Notes: 1. Selectively loaded headers are available, consult TE.
 2. Use Keying Tool No. 91417-1 to remove post for keying.

Note: All part numbers are RoHS compliant.

MTE Headers, Shrouded Latching, Single-Row .100 [2.54] Centerline

.025 [0.64] Square Straight Post (With Swaged Tails and PC Board Orientation)

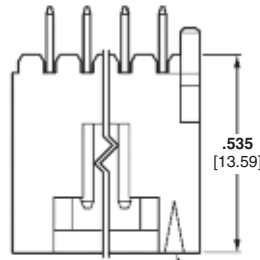

Swaged Retention Tail (See Note)

Material and Finish

Housing — Black thermoplastic, 94V-0 rated

Posts — Brass, plated .000100 [0.00254] tin over .000050 [0.00127] nickel on entire post

Related Product Data

Mateable AMPMODU MTE Products —

Receptacle Assemblies (Polarized/Latching) — pages 230, 231

Receptacle Assemblies with Guide Ribs (installed in Single-Row Coupling Shroud) — pages 232, 233, 235, 240

Technical Documents — pages 277, 278

Product Specification 108-25034

Application Specification 114-25026

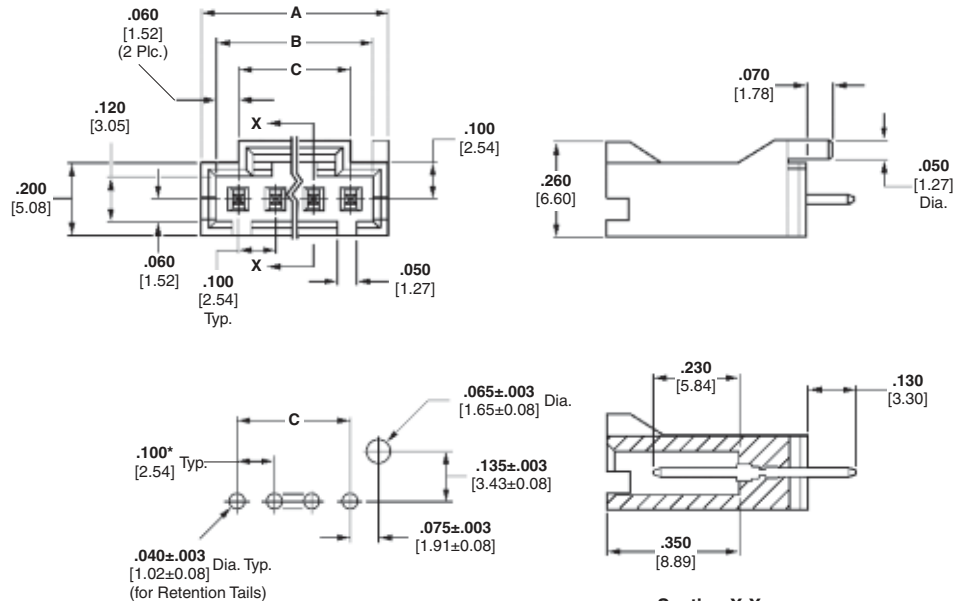

Recommended PC Board Hole Layout

*±.003 [±0.08]; tolerances not to accumulate within one connector pattern.

Note: Swaged retention tails are provided in a minimum of two locations per header.

| No. of Pos. | Dimensions | | | Latching Header |
|-------------|---------------|---------------|--------------|-----------------|
| | A | B | C | |
| 2 | .300 [7.62] | .220 [5.59] | .100 [2.54] | 5-104450-1 |
| 3 | .400 [10.16] | .320 [8.13] | .200 [5.08] | 5-104450-2 |
| 4 | .500 [12.70] | .420 [10.67] | .300 [7.62] | 5-104450-3 |
| 5 | .600 [15.24] | .520 [13.21] | .400 [10.16] | 5-104450-4 |
| 6 | .700 [17.78] | .620 [15.75] | .500 [12.70] | 5-104450-5 |
| 7 | .800 [20.32] | .720 [18.29] | .600 [15.24] | 5-104450-6 |
| 8 | .900 [22.86] | .820 [20.83] | .700 [17.78] | 5-104450-7 |
| 9 | 1.000 [25.40] | .920 [23.37] | .800 [20.32] | 5-104450-8 |
| 10 | 1.100 [27.94] | 1.020 [25.91] | .900 [22.86] | 5-104450-9 |

Note: All part numbers are RoHS compliant.

MTE Headers, Through-hole, Surface Mount Compatible, Shrouded Polarized/Latching, Single-Row .100 [2.54] Centerline

.025 [0.64] Square Straight Post (With Swaged Tails and PC Board Orientation)



Material and Finish

Housing — Black thermoplastic, 94V-0 rated

Posts — Brass, duplex plated .000015 [0.00038] gold on contact area, .000100 [0.00254] min tin on solder tail, with entire post underplated .000050 [0.00127] nickel

Related Product Data

Mateable AMPMODU MTE Products —

Receptacle Assemblies with Guide Ribs (installed in Single-Row Coupling Shroud) — pages 232, 233, 235, 240

Receptacle Assemblies (Polarized Latching) — pages 230, 231

Technical Documents — pages 277, 278

Product Specification 108-25034

Application Specification 114-25026

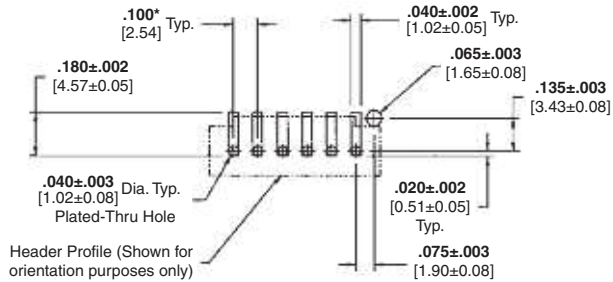
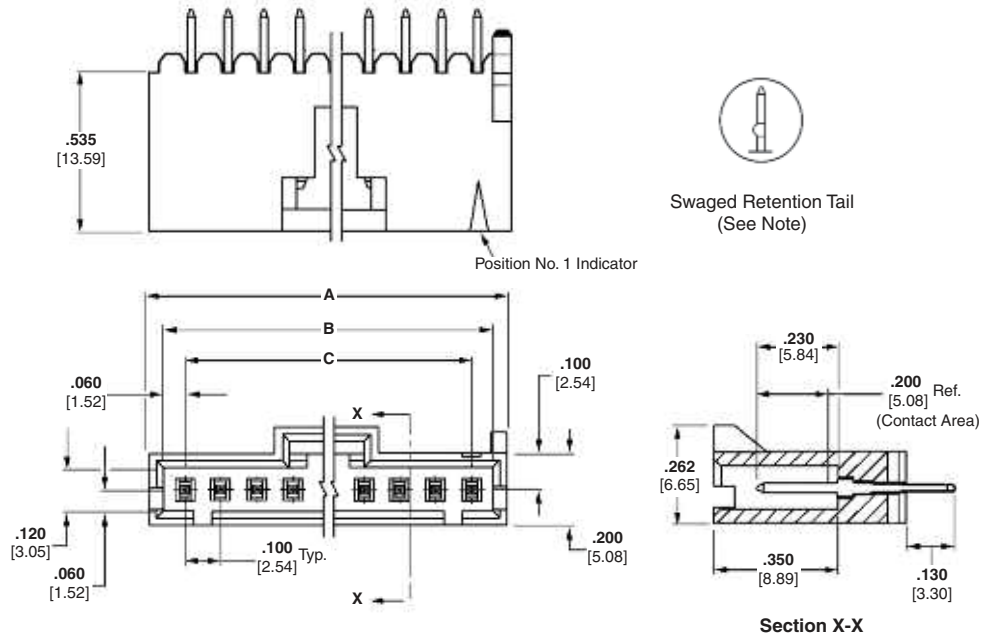

Recommended PC Board Hole Layout (Stencil Thickness = .010 [0.25])
*±.003 [±0.08] tolerance not to accumulate within one connector pattern

| No. of Pos. | Dimensions | | | Polarized/Latching Header, High-Temp |
|-------------|---------------|---------------|---------------|--------------------------------------|
| | A | B | C | |
| 2 | .300 [7.62] | .220 [5.59] | .100 [2.54] | 5-104809-1 |
| 3 | .400 [10.16] | .320 [8.13] | .200 [5.08] | 5-104809-2 |
| 4 | .500 [12.70] | .420 [10.67] | .300 [7.62] | 5-104809-3 |
| 5 | .600 [15.24] | .520 [13.21] | .400 [10.16] | 5-104809-4 |
| 6 | .700 [17.78] | .620 [15.75] | .500 [12.70] | 5-104809-5 |
| 7 | .800 [20.32] | .720 [18.29] | .600 [15.24] | 5-104809-6 |
| 8 | .900 [22.86] | .820 [20.83] | .700 [17.78] | 5-104809-7 |
| 9 | 1.000 [25.40] | .920 [23.37] | .800 [20.32] | 5-104809-8 |
| 10 | 1.100 [27.94] | 1.020 [25.91] | .900 [22.86] | 5-104809-9 |
| 11 | 1.200 [30.48] | 1.120 [28.45] | 1.000 [25.40] | 6-104809-0 |
| 12 | 1.300 [33.02] | 1.220 [30.99] | 1.100 [27.94] | 6-104809-1 |

Note: All part numbers are RoHS compliant.

MTE Headers, Polarized/Latching, Through-Hole, Surface Mount Compatible, Single-Row, .100 [2.54] Centerline

.025 [0.64] Square Right-Angle Post (With Holddown)



Material and Finish

Housing — Black thermoplastic, 94V-0 rated

Posts — Brass, duplex plated .000015 [0.00038] gold on contact area, .000100 [0.00254] min. tin on solder tail, with entire post underplated .000050 [0.00127] nickel

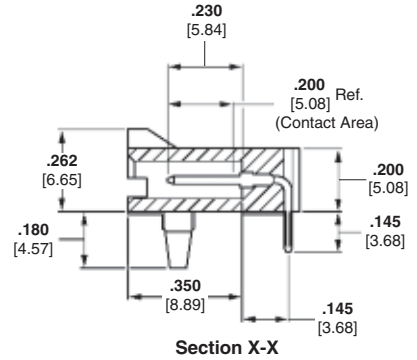
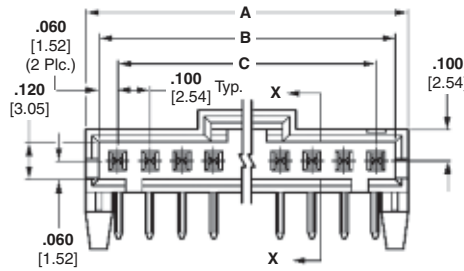
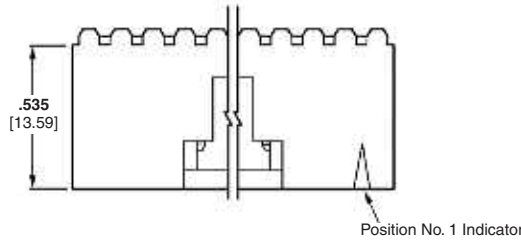

Related Product Data

Mateable AMPMODU MTE Products —

Receptacle Assemblies (Polarized/Latching) — pages 230, 231

Receptacle Assemblies with Guide Ribs (installed in Single-Row Coupling Shroud) — pages 232, 233, 235, 240

Technical Documents — pages 277, 278

Product Specification
108-25034

Application Specification
114-25026

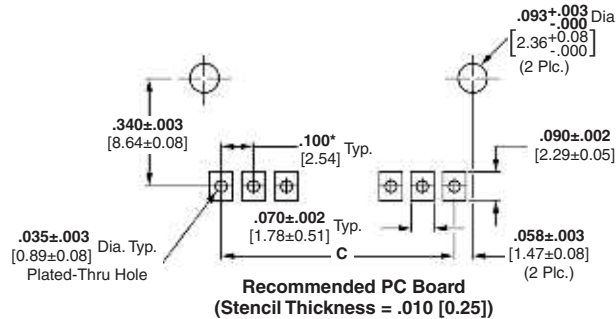

Recommended PC Board
(Stencil Thickness = .010 [0.25])

*±.003 [±0.08]; tolerance is not to accumulate within one connector pattern.

| No. of Pos. | Dimensions | | | Right-Angle Header with Hold Down |
|-------------|---------------|---------------|---------------|-----------------------------------|
| | A | B | C | |
| 2 | .300 [7.62] | .220 [5.59] | .100 [2.54] | 5-104361-1 |
| 3 | .400 [10.16] | .320 [8.13] | .200 [5.08] | 5-104361-2 |
| 4 | .500 [12.70] | .420 [10.67] | .300 [7.62] | 5-104361-3 |
| 5 | .600 [15.24] | .520 [13.21] | .400 [10.16] | 5-104361-4 |
| 6 | .700 [17.78] | .620 [15.75] | .500 [12.70] | 5-104361-5 |
| 7 | .800 [20.32] | .720 [18.29] | .600 [15.24] | 5-104361-6 |
| 8 | .900 [22.86] | .820 [20.83] | .700 [17.78] | 5-104361-7 |
| 9 | 1.000 [25.40] | .920 [23.37] | .800 [20.32] | 5-104361-8 |
| 10 | 1.100 [27.94] | 1.020 [25.91] | .900 [22.86] | 5-104361-9 |
| 11 | 1.200 [30.48] | 1.120 [28.44] | 1.000 [25.40] | 6-104361-0 |
| 12 | 1.300 [33.02] | 1.220 [30.99] | 1.100 [27.94] | 6-104361-1 |
| 13 | 1.400 [35.56] | 1.320 [33.53] | 1.200 [30.48] | 6-104361-2 |

| No. of Pos. | Dimensions | | | Right-Angle Header with Hold Down |
|-------------|---------------|---------------|---------------|-----------------------------------|
| | A | B | C | |
| 14 | 1.500 [38.10] | 1.420 [36.07] | 1.300 [33.02] | 6-104361-3 |
| 15 | 1.600 [40.64] | 1.520 [38.61] | 1.400 [35.56] | 6-104361-4 |
| 16 | 1.700 [43.18] | 1.620 [41.15] | 1.500 [38.10] | 6-104361-5 |
| 17 | 1.800 [45.72] | 1.720 [43.69] | 1.600 [40.64] | 6-104361-6 |
| 18 | 1.900 [48.26] | 1.820 [46.23] | 1.700 [43.18] | 6-104361-7 |
| 19 | 2.000 [50.80] | 1.920 [48.77] | 1.800 [45.72] | 6-104361-8 |
| 20 | 2.100 [53.34] | 2.020 [51.31] | 1.900 [48.26] | 6-104361-9 |
| 21 | 2.200 [55.88] | 2.120 [53.85] | 2.000 [50.80] | 7-104361-0 |
| 22 | 2.300 [58.42] | 2.220 [56.39] | 2.100 [53.34] | 7-104361-1 |
| 23 | 2.400 [60.96] | 2.320 [58.93] | 2.200 [55.88] | 7-104361-2 |
| 24 | 2.500 [63.50] | 2.420 [61.47] | 2.300 [58.42] | 7-104361-3 |
| 25 | 2.600 [66.04] | 2.520 [64.01] | 2.400 [60.96] | 7-104361-4 |

Note: All part numbers are RoHS compliant.

MTE Headers, Right-Angle, Polarized/Latching, Surface Mount

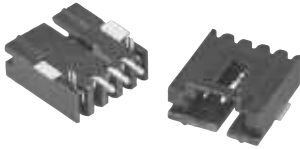

Material and Finish

Housing — Black thermoplastic, 94V-0 rated

Posts — Brass, plated as follows:

Plating A — Duplex plated .000030 [.00076] gold on contact area, .000100 [.00254] min. tin on solder area, with entire post underplated .000050 [.00127] nickel.

Plating B — Duplex plated .000015 [.00038] gold on contact area, .000100 [.00254] min. tin on solder area, with entire post underplated .000050 [.00127] nickel.

Plating C — .000100 [.00254] tin over .000050 [.00127] nickel on entire post

Recommended PC Board Layout

(Refer to MTE Application Spec. 114-25026 for Stencil Aperture Layout Using .006 [0.152] or .008 [0.203] Stencil Thickness)

Related Product Data

Mateable AMPMODU MTE Products —

Receptacle Assemblies (Polarized/Latching) — pages 230, 231

Receptacle Assemblies with Guide Ribs (installed in Single-Row Coupling Shroud) — pages 232, 233, 235, 240

Technical Documents — pages 277, 278

Product Specification
108-25034

Application Specification
114-25026

Note: All part numbers are RoHS compliant.

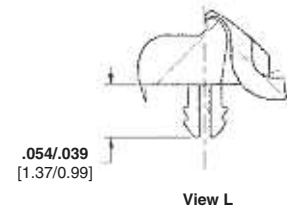
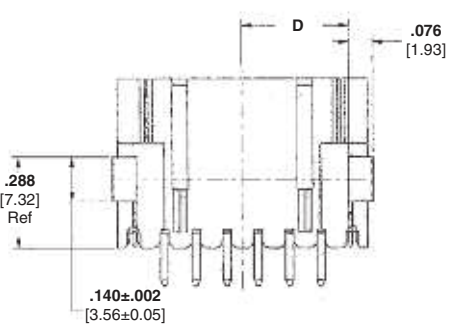
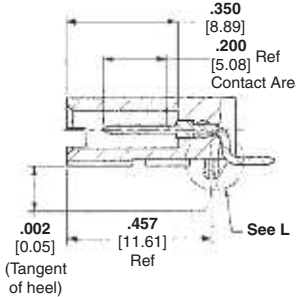
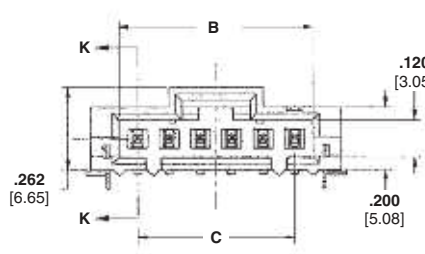
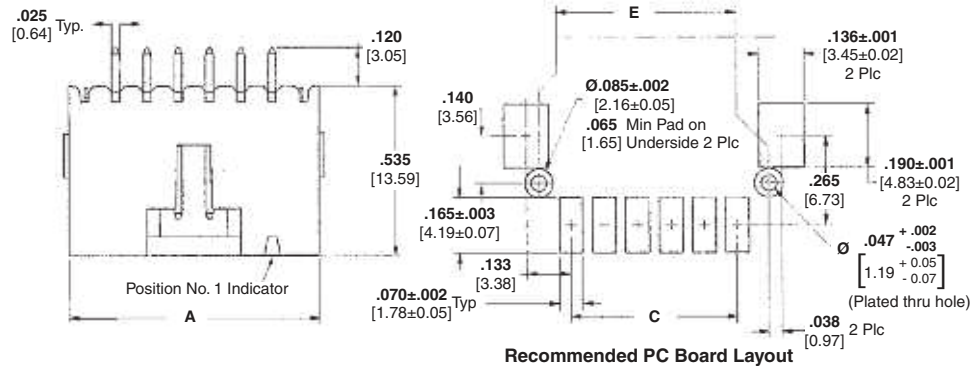

| No. of Pos. | Dimensions | | | | | Right-Angle Latching SMT Headers | | |
|-------------|---------------|---------------|---------------|---------------|---------------|----------------------------------|------------|------------|
| | A | B | C | D | E | Plating A | Plating B | Plating C |
| 2 | .400 [10.16] | .220 [5.59] | .100 [2.54] | .140 [3.56] | .290 [7.37] | 5-147323-1 | 5-147278-1 | 5-147324-1 |
| 3 | .500 [12.70] | .320 [8.13] | .200 [5.08] | .190 [4.83] | .390 [9.91] | 5-147323-2 | 5-147278-2 | 5-147324-2 |
| 4 | .600 [15.24] | .420 [10.67] | .300 [7.62] | .240 [6.10] | .490 [12.45] | 5-147323-3 | 5-147278-3 | 5-147324-3 |
| 5 | .700 [17.78] | .520 [13.21] | .400 [10.16] | .290 [7.37] | .590 [14.99] | 5-147323-4 | 5-147278-4 | 5-147324-4 |
| 6 | .800 [20.32] | .620 [15.75] | .500 [12.70] | .340 [8.64] | .690 [17.53] | 5-147323-5 | 5-147278-5 | 5-147324-5 |
| 7 | .900 [22.86] | .720 [18.29] | .600 [15.24] | .390 [9.91] | .790 [20.07] | 5-147323-6 | 5-147278-6 | 5-147324-6 |
| 8 | 1.000 [25.40] | .820 [20.83] | .700 [17.78] | .440 [11.18] | .890 [22.61] | 5-147323-7 | 5-147278-7 | 5-147324-7 |
| 9 | 1.100 [27.94] | .920 [23.37] | .800 [20.32] | .490 [12.45] | .990 [25.15] | 5-147323-8 | 5-147278-8 | 5-147324-8 |
| 10 | 1.200 [30.48] | 1.020 [25.91] | .900 [22.86] | .540 [13.72] | 1.090 [27.69] | 5-147323-9 | 5-147278-9 | 5-147324-9 |
| 11 | 1.300 [33.02] | 1.120 [28.45] | 1.000 [25.40] | .590 [14.99] | 1.190 [30.23] | 6-147323-0 | 6-147278-0 | 6-147324-0 |
| 12 | 1.400 [35.56] | 1.220 [30.99] | 1.100 [27.94] | .640 [16.26] | 1.290 [32.77] | 6-147323-1 | 6-147278-1 | 6-147324-1 |
| 13 | 1.500 [38.10] | 1.320 [33.53] | 1.200 [30.48] | .690 [17.53] | 1.390 [35.31] | 6-147323-2 | 6-147278-2 | 6-147324-2 |
| 14 | 1.600 [40.64] | 1.420 [36.07] | 1.300 [33.02] | .740 [18.80] | 1.490 [37.85] | 6-147323-3 | 6-147278-3 | 6-147324-3 |
| 15 | 1.700 [43.18] | 1.520 [38.61] | 1.400 [35.56] | .790 [20.07] | 1.590 [40.39] | 6-147323-4 | 6-147278-4 | 6-147324-4 |
| 16 | 1.800 [45.72] | 1.620 [41.15] | 1.500 [38.10] | .840 [21.34] | 1.690 [42.93] | 6-147323-5 | 6-147278-5 | 6-147324-5 |
| 17 | 1.900 [48.26] | 1.720 [43.69] | 1.600 [40.64] | .890 [22.61] | 1.790 [45.47] | 6-147323-6 | 6-147278-6 | 6-147324-6 |
| 18 | 2.000 [50.80] | 1.820 [46.23] | 1.700 [43.18] | .940 [23.88] | 1.890 [48.01] | 6-147323-7 | 6-147278-7 | 6-147324-7 |
| 19 | 2.100 [53.34] | 1.920 [48.77] | 1.800 [45.72] | .990 [25.15] | 1.990 [50.55] | 6-147323-8 | 6-147278-8 | 6-147324-8 |
| 20 | 2.200 [55.88] | 2.020 [51.31] | 1.900 [48.26] | 1.040 [26.42] | 2.090 [53.09] | 6-147323-9 | 6-147278-9 | 6-147324-9 |
| 21 | 2.300 [58.42] | 2.120 [53.85] | 2.000 [50.80] | 1.090 [27.69] | 2.190 [55.63] | 7-147323-0 | 7-147278-0 | 7-147324-0 |
| 22 | 2.400 [60.96] | 2.220 [56.39] | 2.100 [53.34] | 1.140 [28.96] | 2.290 [58.17] | 7-147323-1 | 7-147278-1 | 7-147324-1 |
| 23 | 2.500 [63.50] | 2.320 [58.93] | 2.200 [55.88] | 1.190 [30.23] | 2.390 [60.71] | 7-147323-2 | 7-147278-2 | 7-147324-2 |
| 24 | 2.600 [66.04] | 2.420 [61.47] | 2.300 [58.42] | 1.240 [31.50] | 2.490 [63.25] | 7-147323-3 | 7-147278-3 | 7-147324-3 |
| 25 | 2.700 [68.58] | 2.520 [64.01] | 2.400 [60.96] | 1.290 [32.77] | 2.590 [65.79] | 7-147323-4 | 7-147278-4 | 7-147324-4 |

MTE Headers, Vertical, Polarized/Latching, Surface Mount

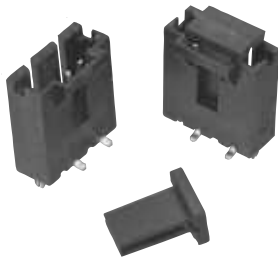

Material and Finish

Housing — Black thermoplastic, 94V-0 rated

Posts — Brass, plated as follows:

Plating A — Duplex plated .000030 [.00076] gold on contact area, .000100 [.00254] min. tin on solder area, with entire post underplated .000050 [.00127] nickel.

Plating B — Duplex plated .000015 [.00038] gold on contact area, .000100 [.00254] min. tin on solder area, with entire post underplated .000050 [.00127] nickel.

Plating C — .000100 [.00254] tin over .000050 [.00127] nickel on entire post

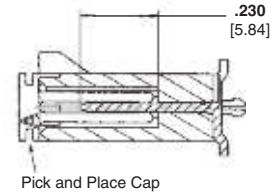
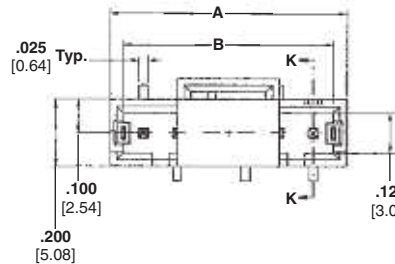
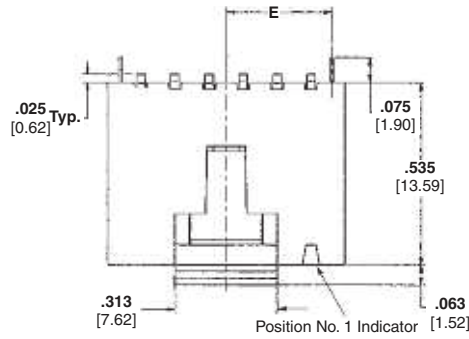

Section K-K

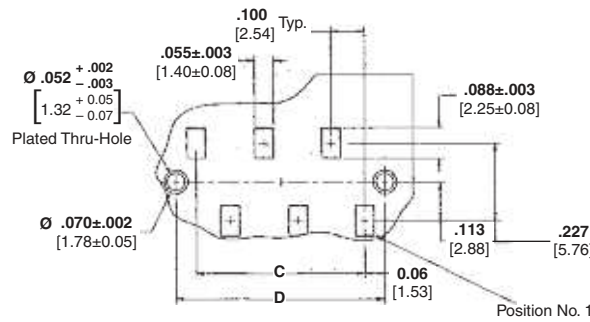

Recommended PC Board Layout

Recommended PC Board Layout

(Refer to MTE Application Spec. 114-25026 for Stencil Aperture Layout using .006 [0.152] or .008 [0.203] stencil thickness

Related Product Data

Mateable AMPMODU MTE Products —

Receptacle Assemblies (Polarized/Latching) — pages 230, 231

Receptacle Assemblies with Guide Ribs (installed in Single-Row Coupling Shroud) — pages 232, 233, 235, 240

Technical Documents — pages 277, 278

Product Specification 108-25034

Application Specification 114-25026

| No. of Pos. | Dimensions | | | | | Vertical SMT Headers | | |
|-------------|--------------|--------------|--------------|--------------|--------------|----------------------|-------------|-------------|
| | A | B | C | D | E | Plating A | Plating B | Plating C |
| 2 | .300[7.62] | .220[5.59] | .100[2.54] | .220[5.60] | .110[2.80] | 5-1375583-1 | 5-1375582-1 | 5-1375549-1 |
| 3 | .400[10.16] | .320[8.13] | .200[5.08] | .320[8.14] | .160[4.07] | 5-1375583-2 | 5-1375582-2 | 5-1375549-2 |
| 4 | .500[12.70] | .420[10.67] | .300[7.62] | .420[10.68] | .210[5.34] | 5-1375583-3 | 5-1375582-3 | 5-1375549-3 |
| 5 | .600[15.24] | .520[13.21] | .400[10.16] | .520[13.22] | .260[6.61] | 5-1375583-4 | 5-1375582-4 | 5-1375549-4 |
| 6 | .700[17.78] | .620[15.75] | .500[12.70] | .620[15.76] | .310[7.88] | 5-1375583-5 | 5-1375582-5 | 5-1375549-5 |
| 7 | .800[20.32] | .720[18.29] | .600[15.24] | .720[18.30] | .360[9.15] | 5-1375583-6 | 5-1375582-6 | 5-1375549-6 |
| 8 | .900[22.86] | .820[20.83] | .700[17.78] | .820[20.84] | .410[10.42] | 5-1375583-7 | 5-1375582-7 | 5-1375549-7 |
| 9 | 1.000[25.40] | .920[23.37] | .800[20.32] | .920[23.38] | .460[11.69] | 5-1375583-8 | 5-1375582-8 | 5-1375549-8 |
| 10 | 1.100[27.94] | 1.020[25.91] | .900[22.86] | 1.020[25.92] | .510[12.96] | 5-1375583-9 | 5-1375582-9 | 5-1375549-9 |
| 11 | 1.200[30.48] | 1.120[28.45] | 1.000[25.40] | 1.120[28.46] | .560[14.23] | 6-1375583-0 | 6-1375582-0 | 6-1375549-0 |
| 12 | 1.300[33.02] | 1.220[30.99] | 1.100[27.94] | 1.220[31.00] | .610[15.50] | 6-1375583-1 | 6-1375582-1 | 6-1375549-1 |
| 13 | 1.400[35.56] | 1.320[33.53] | 1.200[30.48] | 1.320[33.54] | .660[16.77] | 6-1375583-2 | 6-1375582-2 | 6-1375549-2 |
| 14 | 1.500[38.10] | 1.420[36.07] | 1.300[33.02] | 1.420[36.08] | .710[18.04] | 6-1375583-3 | 6-1375582-3 | 6-1375549-3 |
| 15 | 1.600[40.64] | 1.520[38.61] | 1.400[35.56] | 1.520[38.62] | .760[19.31] | 6-1375583-4 | 6-1375582-4 | 6-1375549-4 |
| 16 | 1.700[43.18] | 1.620[41.15] | 1.500[38.10] | 1.620[41.16] | .810[20.58] | 6-1375583-5 | 6-1375582-5 | 6-1375549-5 |
| 17 | 1.800[45.72] | 1.720[43.69] | 1.600[40.64] | 1.720[43.70] | .860[21.85] | 6-1375583-6 | 6-1375582-6 | 6-1375549-6 |
| 18 | 1.900[48.26] | 1.820[46.23] | 1.700[43.18] | 1.820[46.24] | .910[23.12] | 6-1375583-7 | 6-1375582-7 | 6-1375549-7 |
| 19 | 2.000[50.80] | 1.920[48.77] | 1.800[45.72] | 1.920[48.78] | .960[24.39] | 6-1375583-8 | 6-1375582-8 | 6-1375549-8 |
| 20 | 2.100[53.34] | 2.020[51.31] | 1.900[48.26] | 2.020[51.32] | 1.010[25.66] | 6-1375583-9 | 6-1375582-9 | 6-1375549-9 |
| 21 | 2.200[55.88] | 2.120[53.85] | 2.000[50.80] | 2.120[53.86] | 1.060[26.93] | 7-1375583-0 | 7-1375582-0 | 7-1375549-0 |
| 22 | 2.300[58.42] | 2.220[56.39] | 2.100[53.34] | 2.220[56.40] | 1.110[28.20] | 7-1375583-1 | 7-1375582-1 | 7-1375549-1 |
| 23 | 2.400[60.96] | 2.320[58.93] | 2.200[55.88] | 2.320[58.94] | 1.160[29.47] | 7-1375583-2 | 7-1375582-2 | 7-1375549-2 |
| 24 | 2.500[63.50] | 2.420[61.47] | 2.300[58.42] | 2.420[61.48] | 1.210[30.74] | 7-1375583-3 | 7-1375582-3 | 7-1375549-3 |
| 25 | 2.600[66.04] | 2.520[64.01] | 2.400[60.96] | 2.520[64.02] | 1.260[32.01] | 7-1375583-4 | 7-1375582-4 | 7-1375549-4 |

Note: All part numbers are RoHS compliant.

Interchangeable Contacts, Wire Crimp (Snap-In)

Material and Finish

Copper alloy C7025, plated as follows:

Plating A — Duplex plated .000030 [0.00076] min. gold on contact area, .000050 [0.00127] min. tin in crimp area, with entire contact underplated .000050 [0.00127] min. nickel

Plating B — Duplex plated .000015 [0.00038] min. gold on contact area, .000050 [0.00127] min. tin in crimp area, with entire contact underplated .000050 [0.00127] min. nickel

Plating C — .000100 [0.00254] min. tin over .000050 [0.00127] min. nickel on entire contact



Keying Plug
Part No. 104072-1

Ten plugs are supplied per strip.
Order quantity reflects the number of strips required.



Extraction/Lance Reset
Tool No. 843477-1

Short Point Receptacles

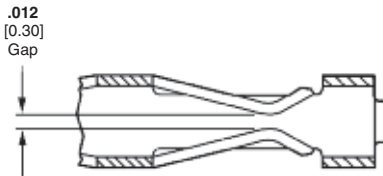
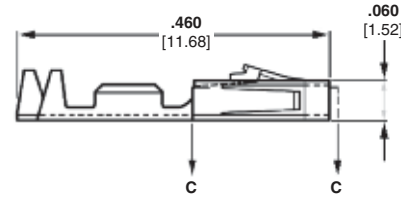
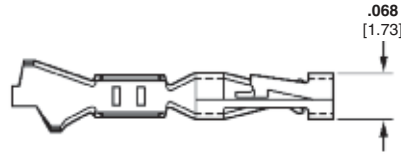

Section C - C

Related Product Data

Performance Characteristics — page 221

Housings used in — Short Point—pages 223, 224

AMPMODU MTE Unloaded Housings — pages 228-233

Application Tooling— pages 270-272

Technical Documents — pages 277, 278

Product Specification
108-1472, 108-1472-1

Application Specification
114-25038

| Wire Size Range AWG [mm ²] | Ins. Dia. Range | Finish | Contact Part No. (Standard Pressure) | | Heavy Duty Miniature Applicator for AMP-O-ELECTRIC Machine* | Applicator for AMP-O-MATIC Stripper/Crimper Machine | Hand Tool Nos. |
|---|------------------------|-----------|--------------------------------------|-------------|---|---|----------------|
| | | | Strip Form | Loose Piece | | | |
| 32-28 0.03-0.08 | .025-.060 0.64-1.52 | Plating A | 1-104481-1 | 1-104481-3 | 567296-2 | 466980-1 | 91518-1 |
| | | Plating B | 1-104481-0 | 1-104481-2 | | | |
| | | Plating C | 5-104481-2 | 5-104481-6 | | | |
| 26-22 0.13-0.3 | .025-.060 0.64-1.52 | Plating A | 1-104480-3 | 1-104480-6 | 567297-2 | 466981-1 | 91518-1 |
| | | Plating B | 1-104480-2 | 1-104480-5 | | | |
| | | Plating C | 1-104480-7 | 1-104480-4 | | | |
| 24-20 0.2-0.5 | .025-.060 0.64-1.52 | Plating A | 1-104479-0 | 1-104479-3 | 567298-2 | 466982-1 | 91551-1 |
| | | Plating B | 1-104479-9 | 1-104479-2 | | | |
| | | Plating C | 1-104479-8 | 1-104479-1 | | | |

*For use with Model "K" machines. Call the Technical Support Center (1-800-522-6752) for part nos. of applicators for use with the Model "G" machines (shown on page 270), as well as other bench machines and fully automatic AMPOMATOR lead making machines.

Note: These wire crimp contacts can be intermixed with insulation displacement crimp contacts.

Note: All part numbers are RoHS compliant.

Interchangeable Contacts, Wire Crimp (Snap-In) (Continued)

Material and Finish

Phosphor bronze, plated as follows:

Plating A — Duplex plated .000030 [0.00076] gold on contact area, .000030 [0.00076] min. tin in crimp area, with entire contact underplated .000050 [0.00127] nickel

Plating B — Duplex plated .000015 [0.00038] gold on contact area, .000030 [0.00076] min. tin on solder area, with entire contact underplated .000050 [0.00127] nickel

Plating C — .000100 [0.00254] tin over .000050 [0.00127] nickel on entire contact

Pins

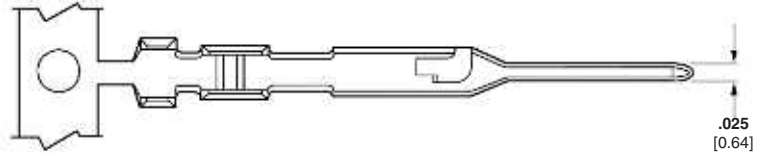

Extraction/Lance Reset
Tool No. 843477-1

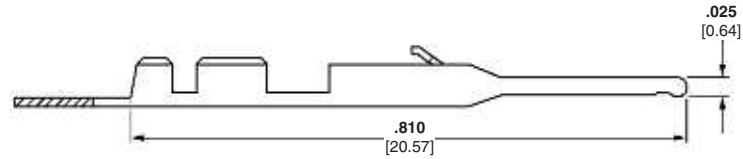

Related Product Data

Performance Characteristics — page 221

AMPMODU MTE Unloaded Housings — pages 228-233

Application Tooling — pages 270-272

Technical Documents — pages 277, 278

Product Specification 108-25034

Application Specification 114-25026

| Wire Size Range AWG [mm ²] | Ins. Dia. Range | Finish | Contact Part No. (Standard Pressure) | | Heavy Duty Miniature Applicator for AMP-O-LECTRIC Machine* | Applicator for AMP-O-MATIC Stripper/Crimper Machine | Hand Tool Nos. |
|---|------------------------|-----------|--------------------------------------|-------------|--|---|----------------|
| | | | Strip Form | Loose Piece | | | |
| 32-28 0.03-0.08 | .025-.054 0.64-1.37 | Plating A | 5-104506-6 | 5-104506-7 | — | — | 58342-2 |
| | | Plating B | 5-104506-4 | 5-104506-5 | | | |
| | | Plating C | 5-104506-2 | 5-104506-3 | | | |
| 26-22 0.14-0.32 | .036-.054 0.91-1.37 | Plating A | 5-104505-6 | 5-104505-7 | 567239-2 | 466983-1 | 91531-1 |
| | | Plating B | 5-104505-4 | 5-104505-5 | | | |
| | | Plating C | 5-104505-2 | 5-104505-3 | | | |

*For use with AMP-O-LECTRIC Model "K" machines. Call Technical Support Center (1-800-522-6752) for part nos. of applicators for use with the AMP-O-LECTRIC Model "G" machines (shown on page 270), as well as other bench machines and fully automatic AMPOMATOR lead making machines.
Note: These wire crimp contacts can be intermixed with insulation displacement crimp contacts.

Note: All part numbers are RoHS compliant.

MT and Shielded MT Interconnection System

Product Facts

- Full line of mass termination tooling offers lowest installed cost for most production needs
- Dual cantilever beams with anti-overstress features provide redundant contact of mating post and limit beam deflection, preventing permanent deformation
- Redundant insulation displacement slots provide for maximum reliability
- Integral wire strain relief on contact can prevent wire motion from being transmitted to wire termination areas
- Built-in contact post stop can protect terminated wire from being disturbed by over-insertion of mating post, prevents wire from entering contact area and positively limits mating connector depth
- Insulation displacement contacts and crimp, snap-in contacts are interchangeable
- Complete serviceability with replacement contacts
- Cover styles include low profile (polarized, non-polarized, latching and ejection) and standard profile (hermaphroditic and ejection)
- Connector housings may be stacked end-to-end within one pair of covers. All varieties of covers in this catalog are suitable for multiple housing stacking applications similar to the example illustrated in the photograph to the right
- Recognized under the Component Program of Underwriters Laboratories Inc., File No. E28476 
- Certified by Canadian Standards Association, File No. LR 7189 

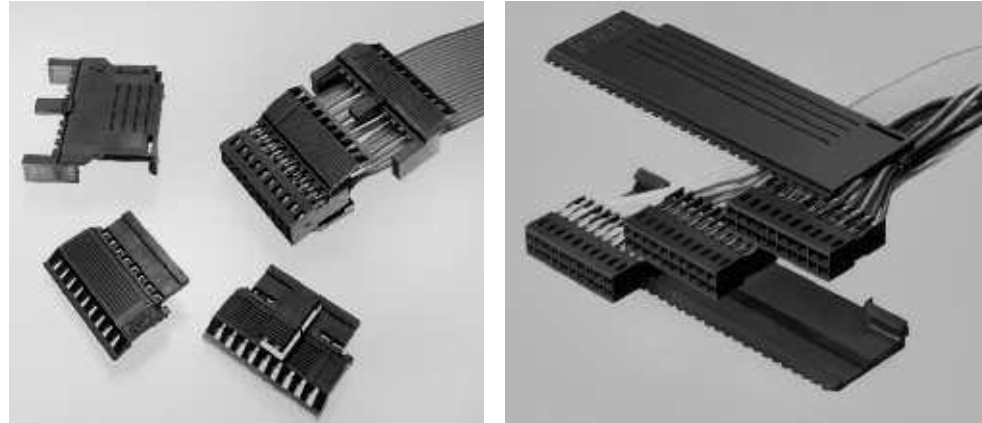

Typical Application of End-to-End Stacking

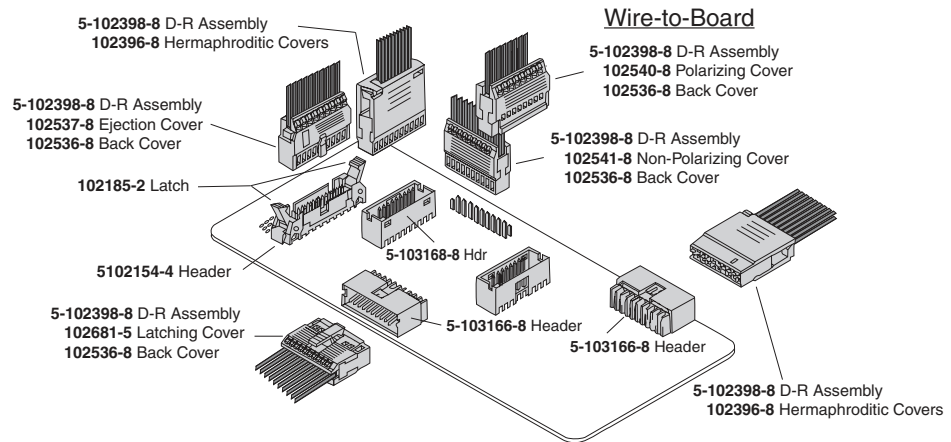

The AMPMODU MT and Shielded MT Interconnection System offers labor and cost savings through mass termination technology, while maintaining the time-proven reliability of the AMPMODU product family. The MT system is comprised of preloaded, double-row receptacle assemblies with snap-on covers and a variety of shielding hardware and accessories. The system is supported by a full line of mass termination tooling to meet virtually most production needs.

The insulation displacement contact, the heart of the MT

system, features a mating interface that is the same as the conventional AMPMODU crimp, snap-in contact, featuring dual cantilever beams, built-in overstress protection and a completely enclosed "box" design.

To reduce EMI/ESD (electromagnetic interference/electrostatic discharge) at the input-output interface, add-on metal shields can be used to convert standard MT connectors to shielded MT connectors.

Performance Characteristics

- Contact Current Rating** — 3 amperes for single contact in free air. (Amperage could vary due to ambient temperature, wire size and duty cycles.)
- Operating Temperature** — -65°C to +105°C
- Termination Resistance** — 12 milliohms max.
- Max. Mating Force** — High pressure - 26 oz. [7.23 N]
Standard pressure - 9 oz. [2.50 N]
- Min. Unmating Force** — High pressure — 5 oz. [1.39 N]
Standard pressure — 1.5 oz. [0.417 N]
- Contact Retention in Housing** — 5 lb. [22.24 N] per contact min.

Note: All part numbers are RoHS compliant.

MT Receptacle Assemblies, Double-Row .100 x .100 [2.54 x 2.54] Centerline

Housings Pre-loaded with Standard Pressure Contacts



Material and Finish

Housing — Glass-filled thermoplastic, black, 94V-0 rated

Contacts — Copper alloy, duplex plated .000030 [0.00076] gold in mating area, .000050 [0.00127] tin on solder tail, with entire contact underplated .000050 [0.00127] nickel

Related Product Data

Mateable Connectors — pages 117, 122, 126, 130, 264

Cable Insulation Wall Thickness — .015 [0.39] max.

Cable Insulation Diameter — .050 [1.27] max.

Mating Post Length — .222-.273 [5.64-6.94] max.

Performance Characteristics — page 255

Replacement Contacts — page 265

Connector Covers — pages 258, 259

Application Tooling — pages 273-275

Technical Documents — pages 277, 278

Product Specification
108-25015, 108-25018, 108-25030

Application Specification
114-25032

Instruction Sheet
408-6532

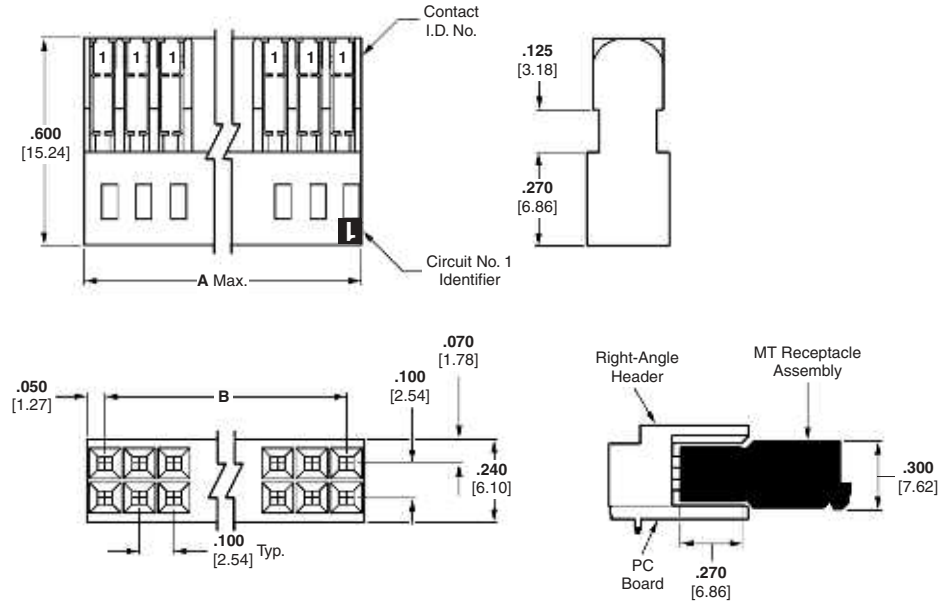

| No. of Pos. | Dimensions | | Part Nos. (Stamped) | | | Unloaded Housings |
|-------------|---------------|---------------|---|--|---|-------------------|
| | A | B | Wire Size Range | | | |
| | | | 30-26 AWG [0.05-0.15 mm ²] | 26-22 AWG [0.12-0.3 mm ²] | 22-20 AWG [0.3-0.6 mm ²] | |
| 6 | .300 [7.62] | .200 [5.08] | 5-102393-1 | 5-102398-1 | 5-102448-1 | 102394-1 |
| 8 | .400 [10.16] | .300 [7.62] | 5-102393-2 | 5-102398-2 | 5-102448-2 | 102394-2 |
| 10 | .500 [12.70] | .400 [10.16] | 5-102393-3 | 5-102398-3 | 5-102448-3 | 102394-3 |
| 12 | .600 [15.24] | .500 [12.70] | 5-102393-4 | 5-102398-4 | 5-102448-4 | 102394-4 |
| 14 | .700 [17.78] | .600 [15.24] | 5-102393-5 | 5-102398-5 | 5-102448-5 | 102394-5 |
| 16 | .800 [20.32] | .700 [17.78] | 5-102393-6 | 5-102398-6 | 5-102448-6 | 102394-6 |
| 18 | .900 [22.86] | .800 [20.32] | 5-102393-7 | 5-102398-7 | 5-102448-7 | 102394-7 |
| 20 | 1.000 [25.40] | .900 [22.86] | 5-102393-8 | 5-102398-8 | 5-102448-8 | 102394-8 |
| 22 | 1.100 [27.94] | 1.000 [25.40] | 5-102393-9 | 5-102398-9 | 5-102448-9 | 102394-9 |
| 24 | 1.200 [30.48] | 1.100 [27.94] | 6-102393-0 | 6-102398-0 | 6-102448-0 | 1-102394-0 |
| 26 | 1.300 [33.02] | 1.200 [30.48] | 6-102393-1 | 6-102398-1 | 6-102448-1 | 1-102394-1 |
| 28 | 1.400 [35.56] | 1.300 [33.02] | 6-102393-2 | 6-102398-2 | 6-102448-2 | 1-102394-2 |
| 30 | 1.500 [38.10] | 1.400 [35.56] | 6-102393-3 | 6-102398-3 | 6-102448-3 | 1-102394-3 |
| 32 | 1.600 [40.64] | 1.500 [38.10] | 6-102393-4 | 6-102398-4 | 6-102448-4 | 1-102394-4 |
| 34 | 1.700 [43.18] | 1.600 [40.64] | 6-102393-5 | 6-102398-5 | 6-102448-5 | 1-102394-5 |
| 40 | 2.000 [50.80] | 1.900 [48.26] | 6-102393-8 | 6-102398-8 | 6-102448-8 | 1-102394-8 |
| 50 | 2.500 [63.50] | 2.400 [60.96] | 7-102393-3 | 7-102398-3 | 7-102448-3 | 2-102394-3 |
| 60 | 3.000 [76.20] | 2.900 [73.66] | 7-102393-8 | 7-102398-8 | 7-102448-8 | 2-102394-8 |
| 64 | 3.200 [81.28] | 3.100 [78.74] | 8-102393-0 | 8-102398-0 | 8-102448-0 | 3-102394-0 |

Note: Contact Extraction/Lance Reset Tool No. 843477-3, see page 265.

Keying Plugs

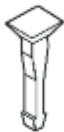

Part No. 86286-1
(Plugs into receptacle contact)

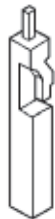

Part No. 87077-2
(Plugs directly into housing)

Material — Natural color nylon

Note: All part numbers are RoHS compliant.

MT Receptacle Assemblies, Double-Row .100 x .100 [2.54 x 2.54] Centerline (Continued)

Housings Pre-loaded with High Pressure Contacts

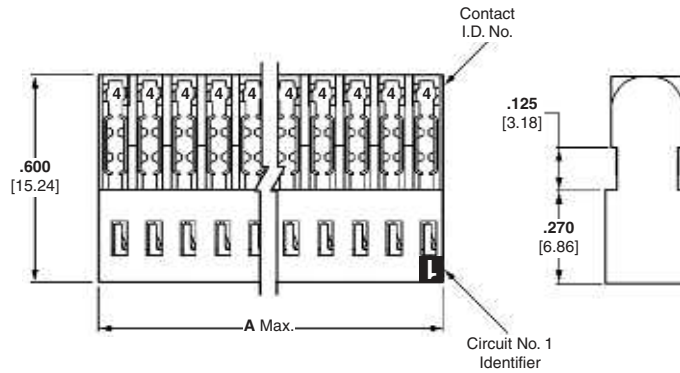

Material and Finish

Housing — Glass-filled thermoplastic, black, 94V-0 rated

Contacts — Copper alloy, duplex plated .000030 [0.00076] gold in mating area, .000050 [0.00127] tin on solder tails, with entire contact underplated .000050 [0.00127] nickel

Related Product Data

Mateable Connectors — pages 117, 122, 126, 130, 264

Cable Insulation Wall Thickness — .015 [0.39] max.

Cable Insulation Diameter — .050 [1.27] max.

Mating Post Length — .200-.273 [5.64-6.94] max.

Performance Characteristics — page 255

Replacement Contacts — page 265

Connector Covers — pages 258, 259

Application Tooling — pages 273-275

Technical Documents — pages 277, 278

Product Specification 108-25015, 108-25018, 108-25030

Application Specification 114-25032

Instruction Sheet 408-6532

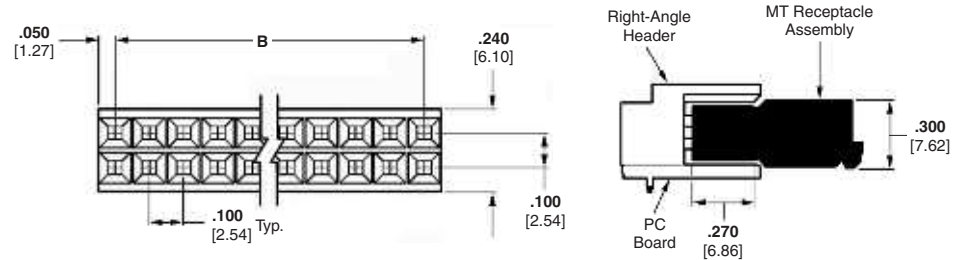

| No. of Pos. | Dimensions | | Part Nos. (Stamped*) | | |
|-------------|---------------|--------------|---|--|---|
| | A | B | Wire Size Range | | |
| | | | 30-26 AWG [0.05-0.15 mm ²] | 26-22 AWG [0.12-0.3 mm ²] | 22-20 AWG [0.3-0.6 mm ²] |
| 6 | .300 [7.62] | .200 [5.08] | 5-102693-1 | 5-102694-1 | 5-102695-1 |
| 8 | .400 [10.16] | .300 [7.62] | 5-102693-2 | 5-102694-2 | 5-102695-2 |
| 10 | .500 [12.70] | .400 [10.16] | 5-102693-3 | 5-102694-3 | 5-102695-3 |
| 12 | .600 [15.24] | .500 [12.70] | 5-102693-4 | 5-102694-4 | 5-102695-4 |
| 14 | .700 [17.78] | .600 [15.24] | 5-102693-5 | 5-102694-5 | 5-102695-5 |
| 16 | .800 [20.32] | .700 [17.78] | 5-102693-6 | 5-102694-6 | 5-102695-6 |
| 18 | .900 [22.86] | .800 [20.32] | 5-102693-7 | 5-102694-7 | 5-102695-7 |
| 20 | 1.000 [25.40] | .900 [22.86] | 5-102693-8 | 5-102694-8 | 5-102695-8 |

*Cavity identification — first cavity (one side); TE Part No. and date code stamped on housing where size permits.

Note: Contact Extraction/Lance Reset Tool No. 843477-3, see page 265.

Keying Plugs

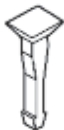

Part No. 86286-1
(Plugs into receptacle contact)



Part No. 87077-2
(Plugs directly into housing)

Material — Natural color nylon

Note: All part numbers are RoHS compliant.

Low Profile Covers for Double-Row MT Receptacle Assemblies

Material

Black thermoplastic, flame retardant

Related Product Data

For use on Double-Row MT Receptacle Assemblies — pages 256, 257

Technical Documents —
pages 277, 278

Product Specification
108-25015, 108-25018, 108-25030

Application Specification
114-25032

Instruction Sheet
408-6532

Note: See page 259 for Low Profile Cover Part Nos.

Front Covers

A - Polarizing Cover
(Mates with AMPMODU 4-sided shrouded headers. Refer to pages 117, 122, 126, 130.)

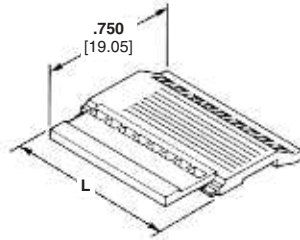

B - Latching Cover
(Mates with AMPMODU 4-sided shrouded headers with extraction slot. Refer to pages 117, 122, 126, 130.)

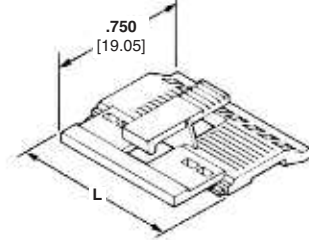

C - Ejection Cover
(Mates with AMP-LATCH universal ejection style pin headers equipped with latching ears, Part No. 102185-2 (with push tabs) or Part No. 102312-2 (without push tabs), see TE Catalog 82012.)

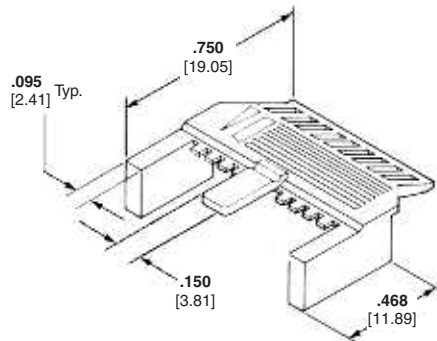

D - Non-Polarizing Cover
(Designed for use with shielded connectors, pages 261 & 262; or for non-polarizing applications.)

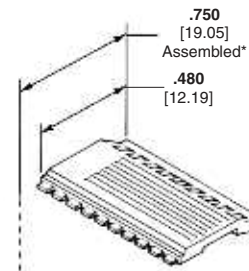

*Dimension applies to cover when installed on connector housing.

Back Covers

E - For Shielding and Non-Shielding Applications
(For use with any low profile cover.)

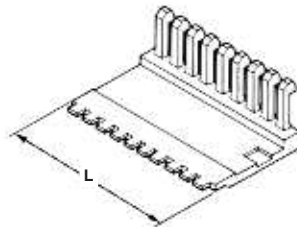

F - For Shielding Applications
(For use with Non-Polarizing Cover only.)

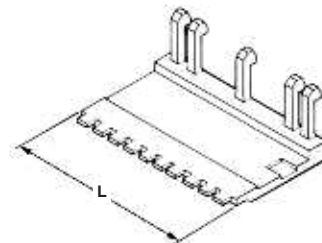

Note: All part numbers are RoHS compliant.

Standard Profile Covers for Double-Row MT Receptacle Assemblies

Material

Black thermoplastic, flame retardant

Related Product Data

For use on Double-Row MT Receptacle Assemblies — pages 256, 257

Technical Documents — pages 277, 278

Product Specification
108-25015, 108-25018, 108-25030

Application Specification
114-25032

Instruction Sheet
408-6532

G - Hermaphroditic Cover

(Two hermaphroditic covers can be used or one hermaphroditic cover can be used with an H Ejection Cover.)

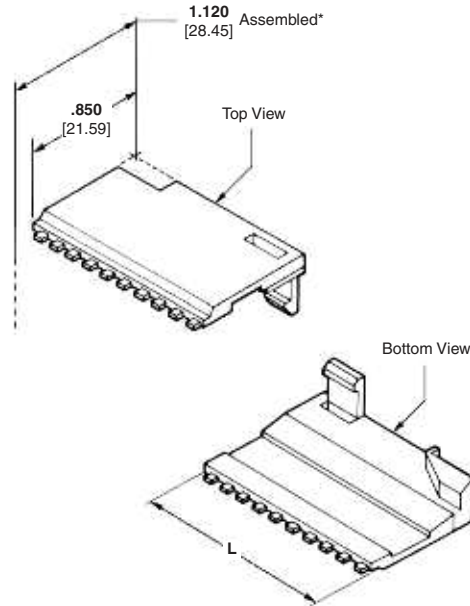

H - Ejection Cover

(Mates with AMP-LATCH universal ejection style pin headers equipped with latching ears, Part No. 102185-2 (with push tabs) or Part No. 102312-2 (without push tabs), see TE Catalog 82012.)

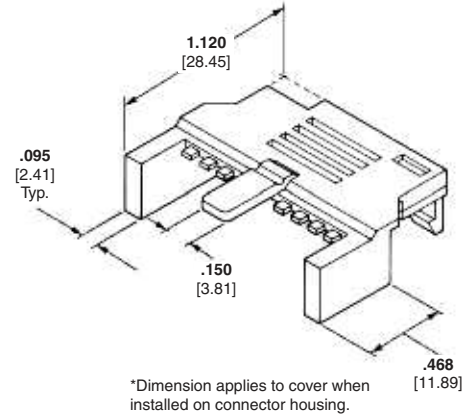

| No. of Pos. | Dimension L | Low Profile Covers | | | | | | Standard Profile Covers | |
|-------------|---------------|--------------------|------------|------------|------------------|--|--------------------------|-------------------------|------------|
| | | Front Covers | | | | Back Covers | | G Hermaphroditic | H Ejection |
| | | A Polarizing | B Latching | C Ejection | D Non-Polarizing | E Shielding and Non-Shielding Applications | F Shielding Applications | | |
| 6 | .300 [7.62] | 102540-1 | — | 102537-1 | 102541-1 | 102536-1 | — | 102396-1 | — |
| 8 | .400 [10.16] | 102540-2 | — | 102537-2 | 102541-2 | 102536-2 | — | 102396-2 | — |
| 10 | .500 [12.70] | 102540-3 | — | 102537-3 | 102541-3 | 102536-3 | — | 102396-3 | — |
| 12 | .600 [15.24] | 102540-4 | 102681-1 | 102537-4 | 102541-4 | 102536-4 | 102823-5 | 102396-4 | — |
| 14 | .700 [17.78] | 102540-5 | 102681-2 | 102537-5 | 102541-5 | 102536-5 | 102823-6 | 102396-5 | — |
| 16 | .800 [20.32] | 102540-6 | 102681-3 | 102537-6 | 102541-6 | 102536-6 | 102823-7 | 102396-6 | — |
| 18 | .900 [22.86] | 102540-7 | 102681-4 | 102537-7 | 102541-7 | 102536-7 | 102823-1 | 102396-7 | — |
| 20 | 1.000 [25.40] | 102540-8 | 102681-5 | 102537-8 | 102541-8 | 102536-8 | 102823-4 | 102396-8 | 103268-6 |
| 22 | 1.100 [27.94] | 102540-9 | 102681-6 | 102537-9 | 102541-9 | 102536-9 | 102823-8 | 102396-9 | — |
| 24 | 1.200 [30.48] | 1-102540-0 | 102681-7 | 1-102537-0 | 1-102541-0 | 1-102536-0 | 102823-9 | 1-102396-0 | 103268-7 |
| 26 | 1.300 [33.02] | 1-102540-1 | 102681-8 | 1-102537-1 | 1-102541-1 | 1-102536-1 | 1-102823-0 | 1-102396-1 | 103268-8 |
| 28 | 1.400 [35.56] | 1-102540-2 | 102681-9 | 1-102537-2 | 1-102541-2 | 1-102536-2 | 1-102823-1 | 1-102396-2 | — |
| 30 | 1.500 [38.10] | 1-102540-3 | 1-102681-0 | 1-102537-3 | 1-102541-3 | 1-102536-3 | 1-102823-2 | 1-102396-3 | 103268-9 |
| 32 | 1.600 [40.64] | — | 1-102681-1 | 1-102537-4 | 1-102541-4 | 1-102536-4 | 1-102823-3 | 1-102396-4 | — |
| 34 | 1.700 [43.18] | — | 1-102681-2 | 1-102537-5 | 1-102541-5 | 1-102536-5 | 1-102823-4 | 1-102396-5 | 1-103268-0 |
| 40 | 2.000 [50.80] | — | 1-102681-5 | 1-102537-8 | 1-102541-8 | 1-102536-8 | 102823-2 | 1-102396-8 | — |
| 50 | 2.500 [63.50] | — | 2-102681-0 | 2-102537-3 | 2-102541-3 | 2-102536-3 | 102823-3 | 2-102396-3 | 1-103268-3 |
| 60 | 3.000 [76.20] | — | — | 2-102537-8 | 2-102541-8 | 2-102536-8 | — | 2-102396-8 | — |
| 64 | 3.200 [81.28] | — | — | 3-102537-0 | 3-102541-0 | 3-102536-0 | — | 3-102396-0 | — |

Note: All part numbers are RoHS compliant.

Shielding Hardware and Accessories for MT Interconnection System

Product Facts

- Add-on shielding accessories for existing AMPMODU Standard MT and PC board mounted headers
- Compact design
- Tin plated copper alloy material
- Redundant cantilever beams provide for good peripheral contact, eliminating the need for a separate RF gasket
- Polarized mating
- 360° cable braid termination with cable jacket support
- Cable shielding hardware permits molded cable terminations after assembly
- Must be used with braided shielded cables
- Solder tabs on right-angle header shields are self-retaining in a PC board



Shielded MT Receptacles

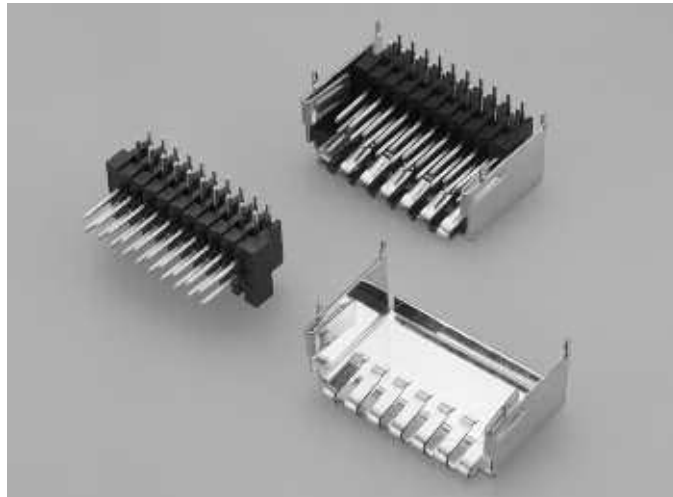

Shielded Right-Angle Headers

The shielded AMPMODU MT system features add-on metal shielding kits for double-row standard MT receptacle assemblies and double-row right-angle headers.

Cable shielding hardware consists of a ferrule and two stamped and formed shell halves. The inner shell half has a series of integral cantilever beams to provide

good peripheral contact with the mating outer shell half. This feature also eliminates the need for a separate RF gasket. Detents in the cantilever beam provide a positive lock when the two halves are mated. During assembly the inner and outer shell halves are snapped together over a terminated standard MT connector.

Shields for right-angle headers have integral cantilever beams which provide good contact with the mating shielded MT receptacle assembly, without the use of a separate RF gasket.

Shielding Hardware and Accessories for Double-Row MT Receptacle Assemblies

Two-Piece Shields— Straight Exit

Material and Finish

Shell Halves — Copper alloy, .020 [0.51] thick; pretinned .000030 [0.00076] min.

Related Product Data

Double-Row MT Receptacle Assemblies — pages 256, 257

Non-Polarizing Covers (Part No. Series 102541 with back cover 102536 or 102823) — pages 258, 259

Shield Ferrules — page 263

Technical Documents — pages 277, 278

Product Specification
108-25015, 108-25018, 108-25030

Application Specification
114-25032

Instruction Sheet
408-6532

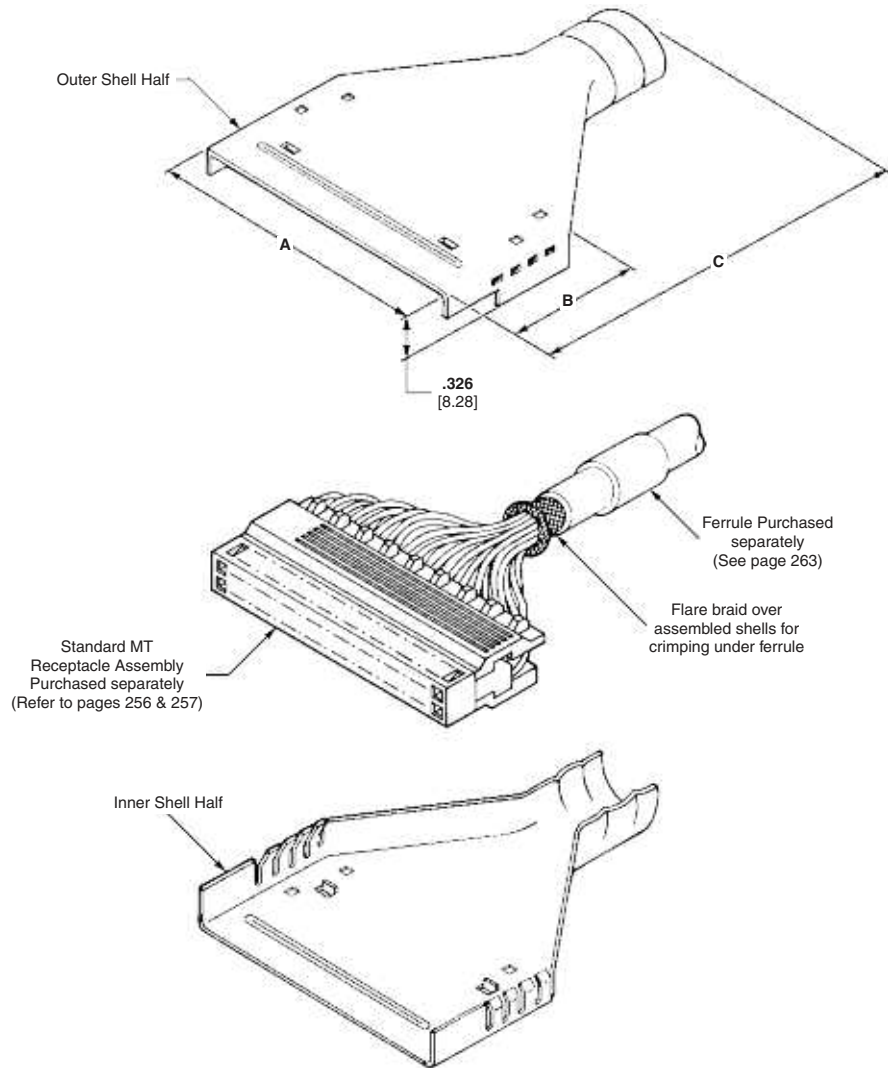

MT Shielding Hardware and Accessories

5

| No. of Pos. | Dimensions | | | Part Nos. | |
|-------------|---------------|---------------|---------------|-------------|-------------|
| | A | B | C | Outer Shell | Inner Shell |
| 6 | .410 [10.41] | .817 [20.75] | 1.268 [32.21] | 102988-2 | 102987-6 |
| 10 | .610 [15.49] | .817 [20.75] | 1.667 [42.34] | 103137-2 | 103136-2 |
| 16 | .910 [23.11] | .950 [24.13] | 1.925 [48.90] | 103153-2 | 103152-2 |
| 26 | 1.410 [35.81] | .950 [24.13] | 1.925 [48.90] | 103341-2 | 103340-2 |
| 40 | 2.110 [53.59] | 1.325 [33.66] | 2.468 [62.69] | 104272-1 | 104271-1 |
| 50 | 2.610 [66.29] | .950 [24.13] | 2.468 [62.69] | 103158-2 | 103157-2 |

Note: Match shield size to number of connector positions.

Note: All part numbers are RoHS compliant.

Shielding Hardware and Accessories for Double-Row MT Receptacle Assemblies (Continued)

Two-Piece Shields— Right-Angle Exit

Material and Finish

Shell Halves — Copper alloy, .020 [0.51] thick; pretinned .000030 [0.00076] min.

Related Product Data

Double-Row MT Receptacle Assemblies — pages 256, 257

Non-Polarizing Covers (Part No. Series 102541 with back cover 102536 or 102823) — pages 258, 259

Shield Ferrules — page 263

Technical Documents — pages 277, 278

Product Specification
108-25015, 108-25018, 108-25030

Application Specification
114-25032

Instruction Sheet
408-6532

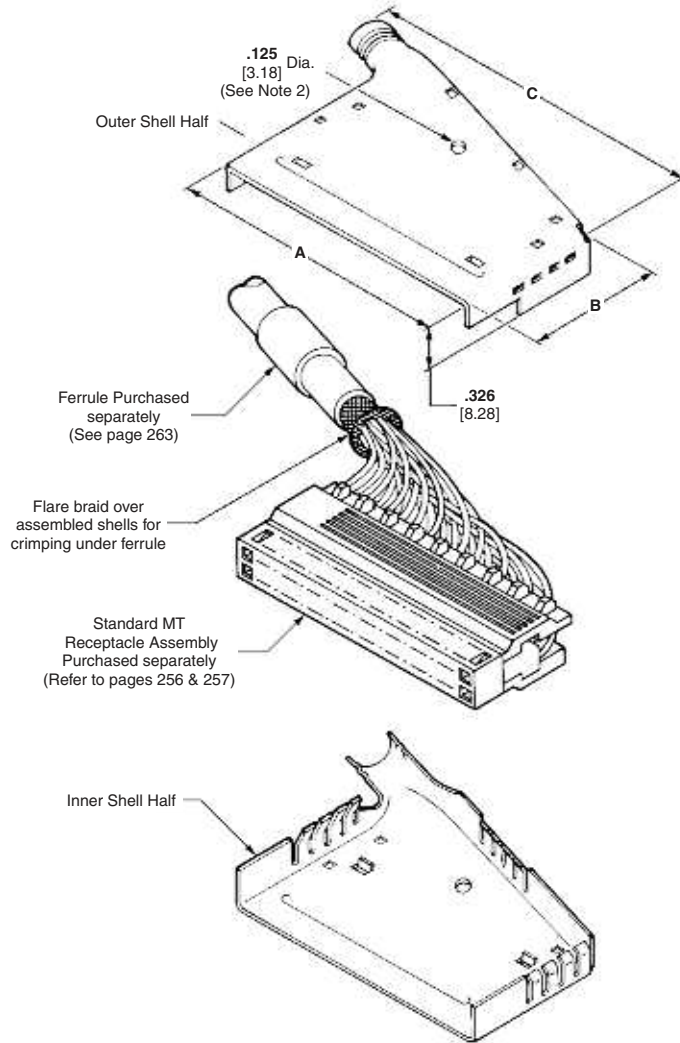

| No. of Pos. | Dimensions | | | Part Nos. | |
|-------------|---------------|---------------|---------------|-------------|-------------|
| | A | B | C | Outer Shell | Inner Shell |
| 18 | 1.010 [25.65] | 1.120 [28.45] | 1.413 [35.89] | 102784-2 | 102783-2 |
| 26 | 1.410 [35.81] | 1.166 [29.62] | 1.975 [50.17] | 103139-2 | 103138-2 |
| 40 | 2.110 [53.59] | 1.135 [28.83] | 2.633 [66.88] | 102786-2 | 102785-2 |
| 50 | 2.610 [66.29] | .983 [24.97] | 3.133 [79.58] | 102788-2 | 102787-2 |
| 60 | 3.110 [78.99] | 1.118 [28.40] | 3.606 [91.59] | 103141-2 | 103140-2 |

Notes: 1. Match shield size to number of connector positions.
2. Hole is provided in 26 through 60-position cable shields for application of optional cable tie pull ring after assembly.

Note: All part numbers are RoHS compliant.

Shielding Hardware and Accessories for Double-Row MT Receptacle Assemblies (Continued)

Ferrules for Shielding Kits

Material and Finish

Soft copper, tin plated

Related Product Data

Used with Shielding Kits —
pages 261, 262

Technical Documents

pages 277, 278

Product Specification

108-25015, 108-25018, 108-25030

Application Specification

114-25032

Instruction Sheet

408-6532

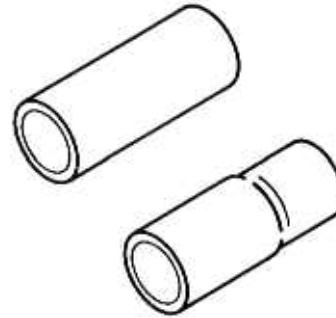

Application Tooling



AMP-O-LECTRIC Model "G" Terminating Machine



TE Hand Tool 91410-1
(Die Set required, see table below)

| No. of Pos. | Straight-Exit Shields | | Right-Angle Exit Shields | | Cable Dia. Range | Ferrule Part Number | Applicator Die* Assembly Part No. | Hand Tool Die Sets | |
|-------------|-----------------------|----------|--------------------------|----------|---------------------------|---------------------|-----------------------------------|--------------------|----------|
| | Outer | Inner | Outer | Inner | | | | Insulation | Braid |
| 6 | 102988-2 | 102987-6 | — | — | 0.200-0.250 [5.08-6.35] | 102985-4 | 812665-2 | 1-527116-8 | 527116-4 |
| | | | | | 0.250-0.300 [6.35-7.62] | 5-102903-2 | 812665-5 | 1-527116-6 | 527116-3 |
| | | | | | 0.310-0.360 [7.87-9.14] | 5-102903-1 | 812665-4 | 1-527116-5 | 527116-3 |
| 10 | 103137-2 | 103136-2 | — | — | 0.370-0.420 [9.40-10.67] | 5-102789-1 | 812665-3 | 1-527116-4 | 527116-3 |
| | | | | | 0.190-0.240 [4.83-6.10] | 5-102903-3 | 812665-6 | 1-527116-7 | 527116-3 |
| | | | | | 0.250-0.300 [6.35-7.62] | 5-102903-2 | 812665-5 | 1-527116-6 | 527116-3 |
| 16 | 103153-2 | 103152-2 | — | — | 0.310-0.360 [7.87-9.14] | 5-102903-1 | 812665-4 | 1-527116-5 | 527116-3 |
| | | | | | 0.370-0.420 [9.40-10.67] | 5-102789-1 | 812665-3 | 1-527116-4 | 527116-3 |
| | | | | | 0.190-0.240 [4.83-6.10] | 5-102903-3 | 812665-6 | 1-527116-7 | 527116-3 |
| 18 | — | — | 102784-2 | 102783-2 | 0.250-0.300 [6.35-7.62] | 5-102903-2 | 812665-5 | 1-527116-6 | 527116-3 |
| | | | | | 0.310-0.360 [7.87-9.14] | 5-102903-1 | 812665-4 | 1-527116-5 | 527116-3 |
| | | | | | 0.370-0.420 [9.40-10.67] | 5-102903-1 | 812665-3 | 1-527116-4 | 527116-3 |
| 26 | 103341-2 | 103340-2 | 103139-2 | 103138-2 | 0.320-0.370 [8.13-9.40] | 5-102903-4 | 812665-9 | 1-527116-3 | 527116-2 |
| | | | | | 0.430-0.460 [10.92-11.68] | 5-102789-2 | 812665-7 | 1-527116-1 | 527116-2 |
| | | | | | 0.320-0.370 [8.13-9.40] | 5-102903-4 | 812665-9 | 1-527116-3 | 527116-2 |
| 40 | 104272-1 | 104271-1 | 102786-2 | 102785-2 | 0.430-0.460 [10.92-11.68] | 5-102789-2 | 812665-7 | 1-527116-1 | 527116-2 |
| | | | | | 0.380-0.420 [9.65-10.67] | 5-102903-6 | 1-812665-5 | 1-527116-2 | 527116-1 |
| | | | | | 0.430-0.460 [10.92-11.68] | 5-102903-5 | 1-812665-4 | 1-527116-1 | 527116-1 |
| 50 | 103158-2 | 103157-2 | 102788-2 | 102787-2 | 0.470-0.520 [11.94-13.21] | 5-102789-3 | 1-812665-3 | 1-527116-0 | 527116-1 |
| | | | | | 0.470-0.520 [11.94-13.21] | 5-102903-8 | 1-812665-8 | — | — |
| | | | | | 0.500-0.545 [12.70-13.84] | 5-102903-7 | 1-812665-7 | — | — |
| 60 | — | — | 103141-2 | 103140-2 | 0.550-0.600 [13.97-15.24] | 5-102789-4 | 1-812665-6 | — | — |
| | | | | | — | — | — | — | — |

*For use with Model "K" machines. Call the TE Technical Support Center (1-800-522-6752) for part nos. of applicators for use with the AMP-O-LECTRIC Model "G" machines (also shown on page 270), as well as other bench machines and fully automatic AMPOMATOR lead making machines.

- Notes:** 1. Ferrules are used with shielding kits shown on pages 261 & 262, and are purchased separately.
2. Individual anvils and crimpers also may be purchased separately.
3. Ferrule Part Number 1-102903-8 also requires Spacer Part Number 527116-9.

Note: All part numbers are RoHS compliant.

Shielded MT Headers for use with Shielded MT Receptacle Assemblies

AMPMODU Right-Angle Headers PC Board Mounted

Material and Finish

Housing — Black thermoplastic, flame retardant

Posts — Copper alloy, plated .000030 [0.00076] gold over .000050 [0.00127] nickel on entire post

Shield — Copper alloy, .020 [0.51] thick; pretinned .000030 [0.00076] min.

Related Product Data

Mating Connectors — Double-Row MT Receptacle Assemblies with Shielding Hardware — pages 256-263

Technical Documents — pages 277, 278

Product Specification
108-25015, 108-25018, 108-25030

Application Specification
114-25032.

Instruction Sheet
408-6532

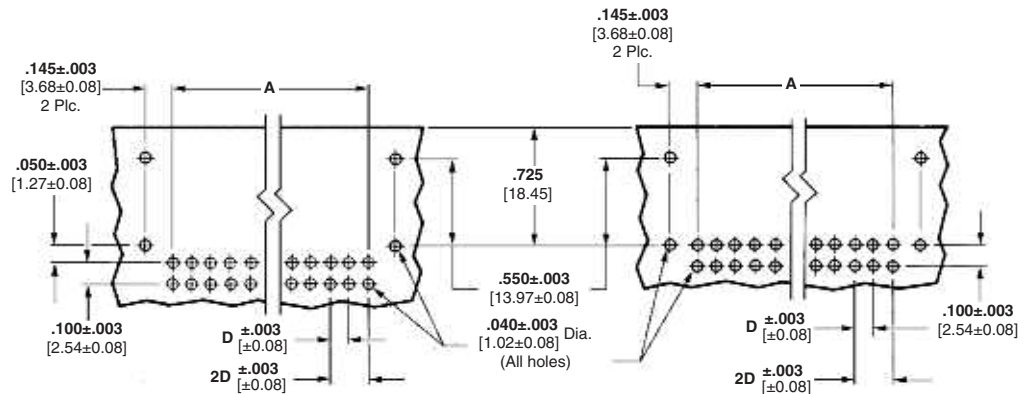
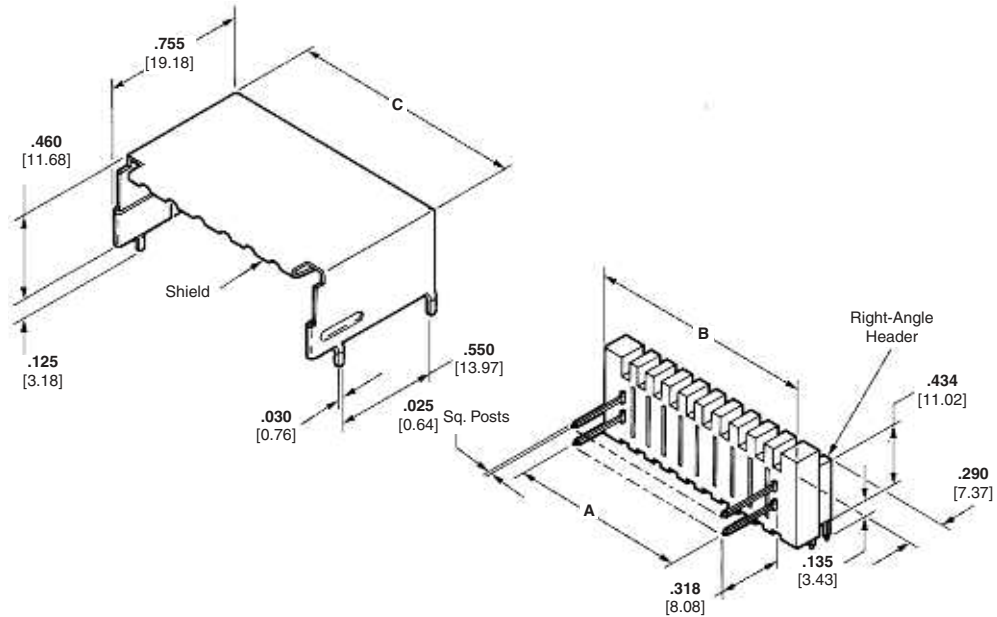

Recommended PC Board Hole Layout for 6, 8 and 10 Positions

Recommended PC Board Hole Layout for 16 thru 50 Positions

D - Contact centerline is .100 [2.54] ±.003 [0.08] tolerances not to accumulate within one connector pattern.

| No. of Pos. | Dimensions | | | Header Part Nos. | Shield Part Nos. |
|-------------|---------------|---------------|---------------|------------------|------------------|
| | A | B | C | | |
| 6 | .200 [5.08] | .430 [10.92] | .510 [12.95] | 102792-6 | 102991-1 |
| 8 | .300 [7.62] | .530 [13.46] | .610 [15.49] | 102792-8 | 102991-2 |
| 10 | .400 [10.16] | .630 [16.00] | .710 [18.03] | 102792-1 | 102791-2 |
| 16 | .700 [17.78] | .930 [23.62] | 1.010 [25.65] | 102792-7 | 102791-3 |
| 18 | .800 [20.32] | 1.030 [26.16] | 1.110 [28.19] | 102792-2 | 102791-4 |
| 20 | .900 [22.86] | 1.130 [28.70] | 1.210 [30.73] | 102792-5 | 1-102791-0 |
| 26 | 1.200 [30.48] | 1.430 [36.32] | 1.510 [38.35] | 102792-9 | 102791-1 |
| 50 | 2.400 [60.96] | 2.630 [66.80] | 2.710 [68.83] | 102792-4 | 102791-8 |

Note: All part numbers are RoHS compliant.

Replacement MT Receptacle Contacts

Insulation Displacement Contacts

Material and Finish

Copper alloy, duplex plated .000030 [0.00076] gold in mating area, .000100-.000200 [0.00254-0.00508] tin in crimp area, with entire contact underplated .000050 [0.00127] nickel

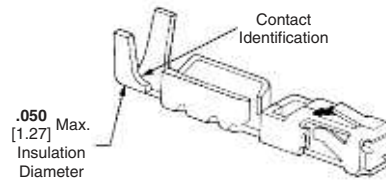

Related Product Data

Performance Characteristics — page 255

Application Tooling — pages 273-275

Technical Documents — pages 277, 278

Product Specification
108-25015, 108-25018, 108-25030

Application Specification
114-25032

Instruction Sheet
408-6532

| Wire Size Range | | Standard Pressure Receptacle | | High Pressure Receptacle | |
|-----------------|--------------------|------------------------------|------------|--------------------------|------------|
| AWG | [mm ²] | Contact Ident. | Part No. | Contact Ident. | Part No. |
| 30-26 | 0.05-0.15 | 1 | 5-102395-2 | 4 | 5-102641-6 |
| 26-22 | 0.12-0.3 | 2 | 5-102399-1 | 5 | 5-102642-6 |
| 22-20 | 0.3-0.6 | 3 | 5-102449-6 | — | — |

Note: Termination tooling for MT receptacle insulation displacement contacts is shown on pages 273-275.

MT receptacle contacts incorporate the following features.

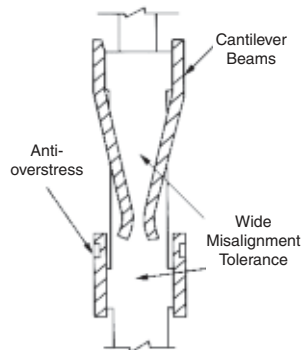

The MT receptacle contact cross-section is primarily rectangular, with rounded corners. Two integral cantilever beams contact the mating square male posts. Deflection of these spring members is limited by anti-overstress and excessive permanent deformation is prevented. This feature allows a wide range for tolerance of misalignment of mating contacts.

The configuration of the receptacle completely encloses the spring members helping to prevent damage during handling and assembly, and makes the system compatible with automatic application techniques.





**Extraction/Lance Reset Tool
No. 843477-3**

Note: All part numbers are RoHS compliant.

Mini-Tandem Spring Receptacle Housings and Contacts

Product Facts

- Individual contacts mate with .025 [0.64] sq. posts, .125 [3.18] long
- Crimp snap-in contacts accept 32-22 AWG [0.03-0.32 mm²] wire
- Retention latch provides for positive installation
- No insertion tool required
- High durability design provides long life
- Available with .000015 [0.00038] or .000030 [0.00076] thick gold inlay in contact areas, or bright tin plated
- Closed-entry housings
- Mini-contact box size: .060 [1.52] sq.
- Mini-Tandem Spring Housings can be stacked on .100 [2.54] centers in either direction
- Mini-Tandem Spring Housings are Recognized under the Component Program of Underwriters Laboratories Inc.,  File No. E28476
- Certified by Canadian Standards Association,  File No. LR 7189

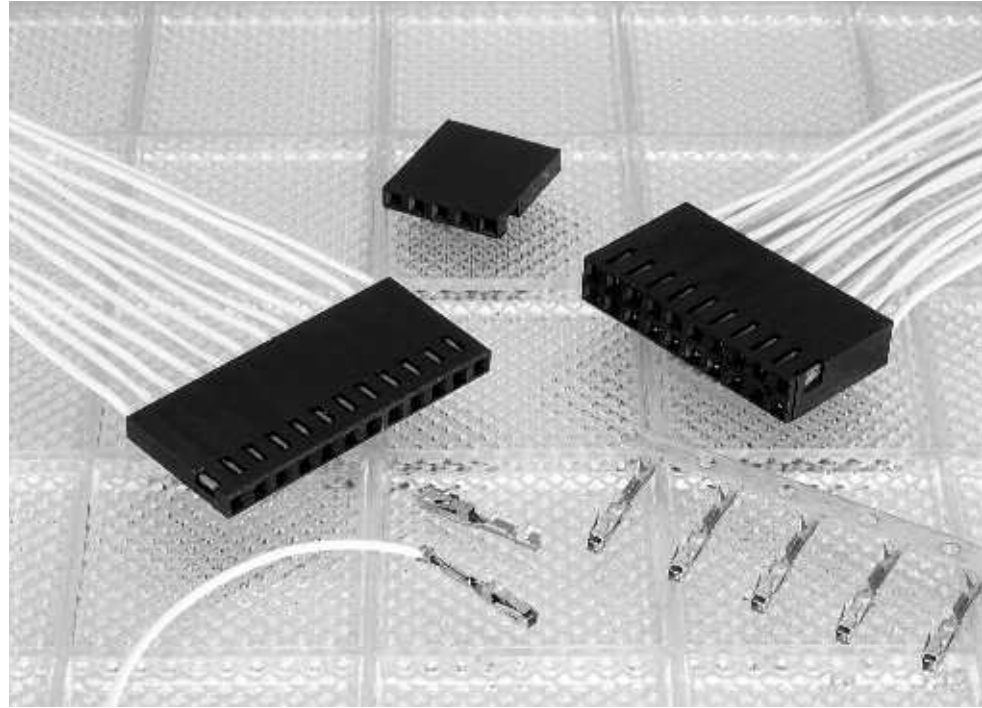

Mini-Tandem Spring Receptacle Contacts are designed to mate with .025 [0.64] posts. When used individually, they will mate with posts as short as .125 [3.18] and when used in a housing, they will mate with .140 [3.55] long posts. These versatile contacts may be used for interconnecting posted pc panels, I/O wiring and cross-connecting pin arrays.

The receptacle contact's box configuration provides for long contact life with controlled contact mating forces which minimize wear. An external retention spring facilitates quick assembly and provides firm seating in a contact housing.

Mini-Tandem Spring Receptacle Contacts are used in single- or double-row housings with .100 [2.54] centerline spacing. Single-row housings can be converted into double-row connectors on .100 x .200 [2.54 x 5.08] centers with the use of stacking clips.

Mini-Tandem Spring Housings can be stacked side-by-side or end-to-end on .100 [2.54] centers.

Specifications

Contact Current Rating — 3 amperes

Termination Resistance — 12 milliohms (max.) — gold plated contacts
18 milliohms (max.) — tin plated contacts

Durability — Ref. Product Specification 108-25031

Mini-Tandem Spring Housings, Single-Row

.100 [2.54] Centerline



Material — Black glass-filled polyester, 94V-0 rated

Technical Documents — pages 277, 278

Product Specification
108-25031

Application Specification
114-25021

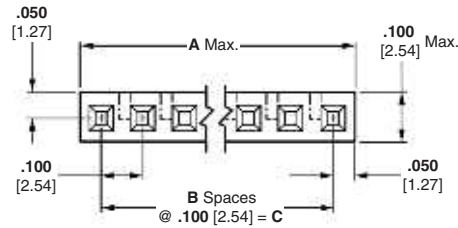
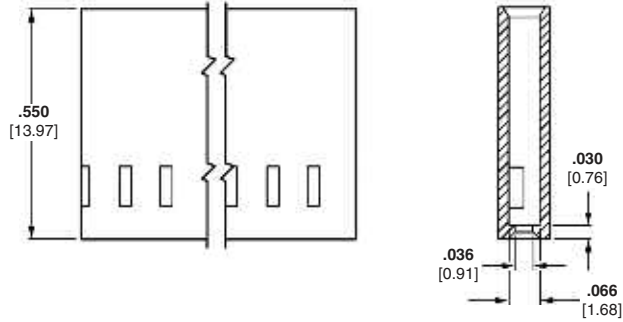

Minimum mating post length is .140 [3.55].

Material—Natural color nylon, 94V-2 rated

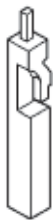

Keying Plug
Part No. 531226-1
(Plugs directly into housing)

Note: Mini-Tandem Spring contacts for use in these housings are shown on page 269.

| No. of Pos. | Dimensions | | | Housing Part No. |
|-------------|---------------|----|---------------|------------------|
| | A | B | C | |
| 2 | .200 [5.08] | 1 | .100 [2.54] | 530554-1 |
| 4 | .400 [10.16] | 3 | .300 [7.62] | 530554-3 |
| 8 | .800 [20.32] | 7 | .700 [17.78] | 530554-7 |
| 12 | 1.200 [30.48] | 11 | 1.100 [27.94] | 1-530554-1 |
| 16 | 1.600 [40.64] | 15 | 1.500 [38.10] | 1-530554-5 |
| 18 | 1.800 [45.72] | 17 | 1.700 [43.18] | 1-530554-7 |
| 20 | 2.000 [50.80] | 19 | 1.900 [48.26] | 1-530554-9 |
| 22 | 2.200 [55.88] | 21 | 2.100 [53.34] | 2-530554-1 |

Note: All part numbers are RoHS compliant.

Mini-Tandem Spring Housings, Double-Row

.100 [2.54] Centerline



Material — Black glass-filled polyester, 94V-0 rated*

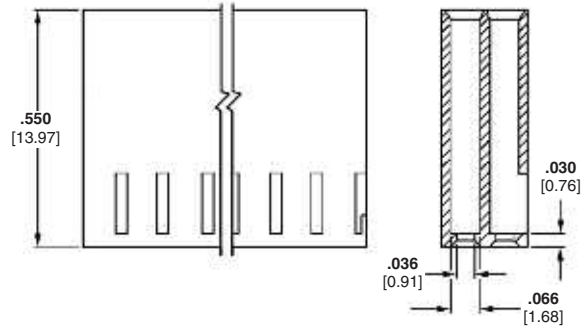

Technical Documents —
pages 277, 278

Product Specification
108-25031

Application Specification
114-25021

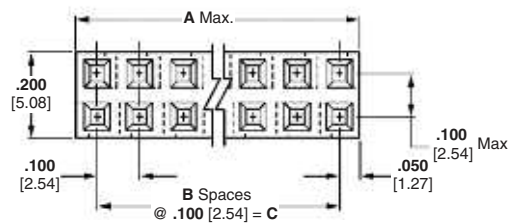

Minimum mating post length is .140 [3.55].

Mini-Tandem Spring Contacts

5

Material — Natural color nylon, 94V-2 rated



Keying Plug
Part No. 531226-1
(Plugs directly into housing)

| No. of Pos. | Dimensions | | | Housing Part No. |
|-------------|--------------|---|--------------|------------------|
| | A | B | C | |
| 6 | .300 [7.62] | 2 | .200 [5.08] | 530902-1 |
| 8 | .400 [10.16] | 3 | .300 [7.62] | 530902-6 |
| 12 | .600 [15.24] | 5 | .500 [12.70] | 2-530902-0 |
| 16 | .800 [20.32] | 7 | .700 [17.78] | 3-530902-0 |

Note: Mini-Tandem Spring contacts for use in these housings are shown on page 269.

*Consult TE for specific UL recognition.

Note: All part numbers are RoHS compliant.

Mini-Tandem Spring Contacts

Receptacle Contacts

Material and Finish

Phosphor bronze, plated as follows:
Plating A — Duplex plated .000030 [0.00076] gold inlay on contact area, matte tin in crimp area, with entire contact underplated .000050 [0.00127] nickel
Plating B — Duplex plated .000015 [0.00038] gold inlay on contact area, matte tin in crimp area, with entire contact underplated .000050 [0.00127] nickel
Plating C — Duplex plated .000050 [0.00127] over matte tin in contact area, over .000030 [0.00076] nickel on entire contact
Plating D — .000100 [0.00254] min. matte tin over .000030 [0.00076] nickel on entire contact

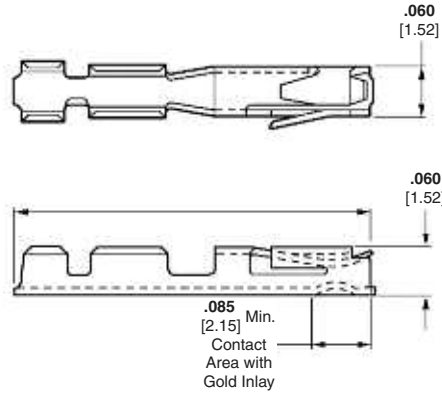

Technical Documents — pages 277, 278

Product Specification
108-25031

Application Specification
114-25021

Low Pressure Contacts

| Wire Size Range AWG | mm ² | Ins. Dia. Range | Finish | Contact Part No. | | Miniature Applicator for AMP-O-LECTRIC Machine* | Applicator for AMP-O-MATIC Stripper/Crimper Machine |
|------------------------|-----------------|--------------------------|-----------|------------------|-------------|--|--|
| | | | | Strip Form | Loose Piece | | |
| 26-22 | 0.14-0.32 | .036-.054 [0.64-1.37] | Plating A | 5531216-3 | 5531216-4 | 466819-2 | 466943-1 |
| | | | Plating B | 5531216-1 | 5531216-2 | | |

Standard Pressure Contacts

| Wire Size Range AWG | mm ² | Ins. Dia. Range | Finish | Contact Part No. | | Miniature Applicator for AMP-O-LECTRIC Machine* | Applicator for AMP-O-MATIC Stripper/Crimper Machine |
|------------------------|-----------------|--------------------------|-----------|------------------|-------------|--|--|
| | | | | Strip Form | Loose Piece | | |
| 32-28 | 0.03-0.08 | .025-.054 [0.64-1.37] | Plating B | 530901-2 | 530901-3 | 466723-1 | 466952-1 |
| | | | Plating C | 5530901-6 | 5530901-7 | | |
| | | | Plating D | 5530901-4 | 5530901-5 | | |
| 26-22 | 0.14-0.32 | .036-.054 [0.91-1.37] | Plating B | 5530553-4 | — | 466819-2 | 466943-1 |
| | | | Plating C | 5530553-6 | — | | |
| | | | Plating D | 5530553-2 | — | | |

High Pressure Contacts

| Wire Size Range AWG | mm ² | Ins. Dia. Range | Finish | Contact Part No. | | Miniature Applicator for AMP-O-LECTRIC Machine* | Applicator for AMP-O-MATIC Stripper/Crimper Machine |
|------------------------|-----------------|--------------------------|-----------|------------------|-------------|--|--|
| | | | | Strip Form | Loose Piece | | |
| 32-28 | 0.03-0.08 | .025-.054 [0.64-1.37] | Plating B | 5531225-6 | — | 466723-1 | 466952-1 |
| 26-22 | 0.14-0.32 | .036-.054 [0.91-1.37] | Plating B | 5531224-6 | — | 466819-2 | 466943-1 |

*For use with AMP-O-LECTRIC Model "K" machines. Call the Tooling/Technical Assistance Center (1-800-522-6752) for part nos. of applicators for use with the AMP-O-LECTRIC Model "G" machines (shown on page 270), as well as other bench machines and fully automatic AMPOMATOR lead making machines.

- Notes:**
1. Mini-Tandem Spring Receptacle Contacts are for use only in the housings shown on pages 267 & 268. They cannot be used in AMPMODU Mod IV Housings.
 2. Use Hand Tool No. 91540-1 for crimping loose-piece receptacles to all wire sizes listed above.
 3. Application tooling is described on pages 270 & 275.

Note: All part numbers are RoHS compliant.

Application Tooling for Wire Crimp Contacts

Tooling shown on this page is designed to terminate wire crimp contacts used in various AMPMODU wire-to-board connectors. Refer to page 88 to determine the applicable connectors.

AMP-O-LECTRIC Model "G" Terminating Machine (Shown with Optional Crimp Force Monitor)

A totally new design of our most popular machine for bench-top operation. It features a quiet and reliable direct motor drive, electronic controls for easy setup and operation, and improved guarding and lighting for operator convenience and safety. All versions include either manual or automatic precision adjustment for crimp height.

For further details, request TE Catalog 65828.



AMP-O-MATIC Stripper/Crimper Machine

Applicators

Several terminating machines, including the AMP-O-LECTRIC Model "G", AMP-O-MATIC Stripper/Crimper and AMPOMATOR CLS machines, are designed for use with interchangeable applicators. Basic styles are quickly interchangeable to minimize costly downtimes, and feature dial-in wire and insulation crimp height settings. Special applicators are available for use with the Crimp Force Monitor (see page 272), for measuring the crimp height of each termination as it is made, plus evaluating the quality of each crimp.



This machine automatically strips as well as terminates individual wires. Similar to the AMP-O-LECTRIC Model "G" machine, applicators are quickly interchangeable, and it includes precision adjustment for crimp height. All adjustments can be made from the front of the machine, without special tools.

For further details, request TE Catalog 65004.



Heavy Duty Miniature Applicators



EDGE, Electronic Applicator Counter

The new versatile EDGE applicator counter tracks wearable tool usage for the most effective maintenance planning. The completely electronic counter with clear LCD display, indicates cycles since installation. By performing maintenance at measured intervals with pre-set limits, operators avoid breakdowns and rejects caused by tool wear or mid-adjustment. For more information, request catalog 1773385.

Application Tooling for Wire Crimp Contacts (Continued)

AMP 3K/40 and AMP 5K/40 Terminators

As a value oriented terminator, the AMP 3K/40 and AMP 5K/40 are designed for customers that require the increased output and quality of a semiautomatic machine at a competitive price. By incorporating the most commonly requested features as standard and offering a long list of optional equipment, these terminators offer flexibility to meet the specific needs of various applications at the lowest possible cost.



AMP 5K/40 Terminator

Optional Stripping Module for the AMP 3K/40, AMP 5K/40 and the AMP-O-LECTRIC Model G

The combination of the Stripping Module with the AMP-O-LECTRIC Model G Terminator or the AMP 3K/40, 5K/40 provides an economical, proficient method of stripping wire and crimping terminals on the same machine. Wires are stripped moments before crimping, meaning there is virtually no chance of damaging wire conductors during handling or storage. Once the wire is fed into the start sensor, the Stripping Module does the rest, improving placement accuracy. For more information, request catalog 1309085.

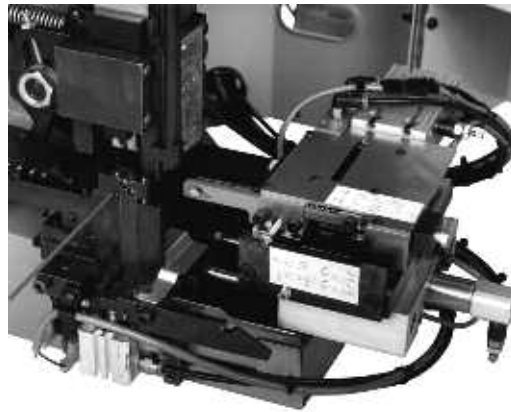

Application Tooling for Wire Crimp Contacts (Continued)

Tooling shown on this page is designed to terminate wire crimp contacts used in various AMPMODU wire-to-board connectors. Refer to page 88 to determine the applicable connectors.

Crimp Force Monitor (CFM)



Your quality program calls for more than a good crimping system. It demands proof - the proof you get with the SLE Crimp Force Monitor. It has high-resolution piezo-quartz sensor technology for a more precise identification of typical crimping faults. The monitor features Zone & Peak Force Analysis, 128x128 Dot Matrix, Force Trigger and Encoder Proximity Trigger, and Absolute Force Measurement for real-time monitoring of every crimp. The CFM can be used with bench or fully-automatic machines. Special applicators are not required.

Sure, you can sample and test crimp height with a micrometer. In fact, that's how you standardize your process. But for ongoing quality control, testing every crimp, SLE is the choice. It's known worldwide, and meets our standards for a high performance terminating system. That's how you can be sure.

High quality crimping - with verification - means higher production and productivity.

AMPOMATOR System III Leadmaker



The AMPOMATOR System III is an automatic machine for the production of terminated wire leads. The machine combines state of the art technology to process single and double wire application utilizing the wire processing industry's best and most friendly subsystems and accessories available to meet the latest market requirements for wire lead production.

The new machine incorporates a servo-driven, software-controlled AMP-O-LECTRIC ST III terminator and the next generation System III Applicator.

See catalog 1654956-5 for more information.



Commercial PRO-CRIMPER III Hand Tool



Commercial grade hand tool for crimping various products. Features ratchet control to provide complete crimp cycle. Accepts both pinned- and shouldered-style die sets. Locators are provided with pinned-style die sets for proper contact and wire positioning, and to help minimize contact rotation and bending during crimping. Approximate weight 1.3 lb [0.60 kg].

Premium CERTI-CRIMP Straight Action Hand Tool (SAHT)



TE hand tools are ideal for small production and prototype applications. They feature ratchet control to help eliminate partial crimps,

straight-line die closure, terminal locator and support, and insulation crimp adjustment. TE hand tools also can be adapted for use with pneumatic tooling assemblies, providing air operated crimping capabilities.

For further details on TE straight action hand tools, request TE Catalog 65780. For more details on TE pneumatic tooling assemblies, call the TE Technical Support Center, 1-800-522-6752.



Application Tooling for Insulation Displacement Crimp (IDC) Contacts and Connectors

Tooling shown on this page is designed to terminate IDC contacts for various AMPMODU wire-to-board connectors. Refer to page 88 to determine the applicable connectors.

Pistol Grip Manual and Air Powered Tools

The manual pistol grip tool features an interchangeable modular terminating head which also can be used in the pneumatic version, the Bench Mount Pneumatic Power Assembly and the IDC Electric Power Unit. The head terminates one unstripped wire per cycle and indexes the connector to the next terminating position. The head rotates to permit optimum access to the wiring area.

The Bench Mount Pneumatic Power Assembly is air actuated with either a foot or knee switch. This capability frees the operator's hands for optimum positioning.

Modular Heads:

- 58062-1** (for MT connectors)
- 58336-1** (for MTE connectors)
- 58395-1** (for Level V IDC connectors)
- 58540-1** (for MTE connectors, discrete wire or flat ribbon cable)



**Manual Pistol Grip
Tool No. 58074-1**



**Pneumatic Pistol Grip
Tool No. 58075-1**



**Bench Mounted Pneumatic Power Assembly
No. 58338-1**

Modular Head Tool No. 58540-1



This modular head tool can be used on any pistol grip tool. It was designed for discrete wire or flat ribbon cable applications.

Note: All part numbers are RoHS compliant.



**IDC Electric Power Unit
No. 931800-1**

IDC Electric Power Unit

This electrically powered semiautomatic bench machine is designed for applying AMPMODU MTE and MT connectors to discrete wires. It is portable and compact and uses existing pistol grip modular heads. The heads are easily interchanged to run different products. *The IDC Electric Power Unit's cycle rate is approximately 7,200 cycles per hour, with exact production rates depending upon operator dexterity.

Modular Heads:

- 58062-1** (for MT connectors)
- 58336-1** (for MTE connectors)

*A tube-fed track assembly, Part No. 856675-1, also can be used with MTE Connectors.

Application Tooling for Insulation Displacement Crimp (IDC) Contacts and Connectors (Continued)

Tooling shown on this page is designed to terminate IDC contacts for various AMPMODU wire-to-board connectors. Refer to page 88 to determine the applicable connectors.

Tube-Fed Ribbon Cable Machine

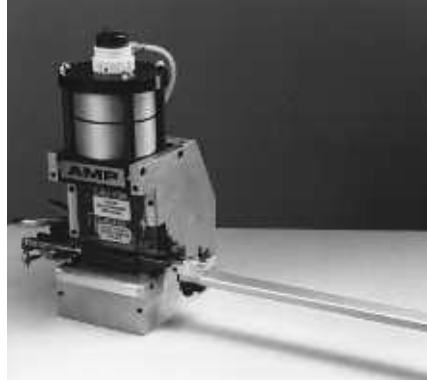

Tube-Fed Ribbon Cable Machine No. 856002-1

Designed for bench applications, this machine is pneumatically operated and controlled by a foot pedal. It terminates connectors onto end-notched ribbon cable. *The connectors are supplied in strip form and in plastic tubes. The machine consists of three basic sub-assemblies: a feed track, a terminating station and a seating station. The feed track is a constant force,

spring-driven unit which conveys connectors through the product tube to the terminating station. The air-operated terminating station positions and terminates contacts onto the notched cable. The seating station is manually operated and seats connector housings onto the terminated contacts.

*At a rate of 13-25 positions at a time.

2700 lb. Power Unit With Cable Notching Die



2700 lb. Power Unit No. 312522-1

Equipped with a cable notching die an adapter kit, this fully pneumatic bench machine provides the 2700 lb [12 010N] force required for end-notching ribbon cable. It features a grooved cable support plate, a pressure plate and a cable stop to facilitate cable alignment and positioning during the notching process.

Notching Dies:

854449-1 (for 24-22 AWG [0.2-0.6 mm²] Wire)

854449-2 (for 28-26 AWG [0.08-0.15 mm²] Wire)

Note: All part numbers are RoHS compliant.

Application Tooling for Insulation Displacement Crimp (IDC) Contacts and Connectors (Continued)

Tooling shown on this page is designed to terminate IDC contacts for various AMPMODU wire-to-board connectors. Refer to page 88 to determine the applicable connectors.

CHAMPOMATOR Model 2.5 Terminating Machine No. 354786-(*)



This compact bench machine terminates wires manually sorted from multiconductor cables. Termination sequence may include full termination of all contacts, or selective termination. Designed for easy programming, the machine is microprocessor controlled

and programmed by a membrane switch keyboard. It also has an internal storage capability for retaining up to 350 cable assemblies. Connectors can be terminated with either straight or right-angle wire dress.

*For applicable dash nos., call the Technical Support Center: 1-800-522-6752. For further details, request TE Catalog 82247

CHAMPOMATOR Model 3A Terminating Machine No. 761420-(*)



This floor model machine automatically sorts wires from multiconductor jacketed cable and terminates them in a user-determined sequence; either full termination of all contacts, or selective termination. Designed for easy programming, the machine is microprocessor

controlled and programmed by a touchscreen. It also has an internal storage capability for retaining up to 50 cable assemblies. Connectors can be terminated with either straight or right-angle wire dress. All cable assemblies are tested for continuity and shorts.

*For applicable dash nos., call the Technical Support Center: 1-800-522-6752. For further details, request TE Catalog 82247

Note: All part numbers are RoHS compliant.

Technical Documents for Board-to-Board Products

Various technical documents are available for your use.

Product Specifications describe technical performance characteristics and verification tests. They are intended for the Design, Component and Quality Engineers.

PC/104 and PC/104-Plus Connectors — Pages 5-12:

108-1956 PC/104 and PC/104-Plus Connector Systems

Receptacle Assemblies and Unshrouded Breakaway Headers, Surface-Mount — Pages 109, 110, 185-192:

108-25017 AMPMODU Interconnection System, Two-Piece
 108-25022 AMPMODU Mod. IV Interconnection System, Vertical Assemblies
 108-25026 AMPMODU Mod. II Interconnection System, Standard Pressure Receptacle Assembly and Header

Two-Piece Printed Circuit Board Connectors — Pages 193-202:

108-16 ACTION PIN Contacts
 108-25017 AMPMODU Interconnection System, Two-Piece
 108-25027 AMPMODU Mod. II Interconnection System, Short-Point Receptacle Assembly and Header

Receptacle Assemblies, Horizontal and Vertical Board Mount — Pages 168-192:

108-25022 AMPMODU Mod. IV Interconnection System, Vertical Assemblies
 108-25026 AMPMODU Mod. II Interconnection System, Standard Pressure Receptacle Assembly and Header
 108-25027 AMPMODU Mod. II Interconnection System, Short-Point Receptacle Assembly and Header

.025 [0.64] Square Posts, Headers, Accessories and Tooling — Pages 92-105, 114-140, 145-153, 163:

108-16 ACTION PIN Contacts
 108-25026 AMPMODU Mod. II Interconnection System, Standard Pressure Receptacle Assembly and Header

Application Specifications describe requirements for using the product in its intended application, and/or crimping information. They are intended for the Packaging and Design Engineers and the Setup person.

PC/104 and PC/104-Plus Connectors — Pages 5-12:

114-13021 PC/104 and PC/104-Plus Connectors

Two-Piece Printed Circuit Board Connectors — Pages 193-202:

114-9009 AMPMODU Header, Two-Piece, Double Row, Application of

Receptacle Assemblies, Horizontal and Vertical Board Mount — Pages 168-192:

114-25018 AMPMODU Mod. II and IV Receptacle Assembly, PC Board Mounted, Vertical, Application of

.025 [0.64] Square Posts, Headers, Accessories and Tooling — Pages 92-105, 114-140, 145-153, 163-167:

114-25028 ACTION PIN Contacts with TE Headers, Application
 114-13011 AMPMODU .025 and .045 Square Continuous Posts

Instruction Sheets provide instructions for assembling or applying the product. They are intended for the Manufacturing Assembler or Operator.

PC/104 and PC/104-Plus Connectors — Pages 5-12:

408-8502 Future Board Assembly 1424685 for PC/104 and PC/104-Plus Connectors
 408-8503 Seating Tool Assembly 1424686 for PC/104 and PC/104-Plus Connectors
 408-8504 Pneumatic Seating Tool Assembly 1424930-1 for PC/104 and PC/104-Plus Connectors
 408-8505 Manual Seating Tool Assembly 1424931-1 for PC/104 and PC/104-Plus Connectors

Two-Piece Printed Circuit Board Connectors — Pages 193-202:

408-2636 ACTION PIN Contact Rear Insertion/Extraction Tool 265871-7
 408-9054 Seating Tools

Receptacle Assemblies, Horizontal and Vertical Board Mount — Pages 168-192:

408-7411 Suggestions for Wave Soldering Vertical AMPMODU Receptacles

.025 [0.64] Square Posts, Headers, Accessories and Tooling — Pages 92-105, 114-140, 145-153, 163:

408-2636 ACTION PIN Contact Rear Insertion/Extraction Tool 265871-7
 408-6944 TE Uninsulated Bandolier Post Insertion Tool 91419-1
 408-7977 AMPMODU Double Row, Straight Posts, End Shrouds .100 x .100 [0.64 x 0.64] Centers
 408-7878 AMPMODU Header Barrier Inserts
 408-9054 ACTION PIN Contact Headers Seating Tool, 91170 Series
 408-9707 Tool Kit 314818-1 for Breakaway Headers

Handbook
5697

Guide to Application of ACTION PIN Contact Connectors

Note: All part numbers are RoHS compliant.

Technical Documents for Wire-to-Board Products

Various technical documents are available for your use.

Product Specifications describe technical performance characteristics and verification tests. They are intended for the Design, Component and Quality Engineers.

Locking Clip Contacts and Housings — Pages 206-209:

- 108-36028 Connector, Locking Clip, .025 [0.64] Square, Gold
- 108-36028-1 Connector, Locking Clip, .025 [0.64] Square, Tin

Mod. IV Wire-Applied Contacts and Housings — Pages 210-220:

- 108-25007 AMPMODU Mod. V Interconnection System, Wire-Applied (High Pressure)
- 108-25019 AMPMODU Mod. IV Male Connectors
- 108-25020 AMPMODU Mod. IV Interconnection System, (Standard Pressure)
- 108-25021 AMPMODU Mod. IV.V Interconnection System, (Intermediate Pressure)

Short-Point Wire-Applied Contacts and Housings — Pages 221-224:

- 108-1472 Short-Point Contacts and Housings

AMPMODU MTE Interconnection System — Pages 225-252:

- 108-25034 AMPMODU MTE Connectors

AMPMODU MT and Shielded MT Interconnection System — Pages 255-265:

- 108-25015 AMPMODU MT Standard Pressure Connectors
- 108-25018 AMPMODU MT High Pressure Connectors
- 108-25030 AMPMODU MT Shielding Accessories

AMPMODU Level V, IDC Connectors —

- 108-25028 Interconnection System, Insulation Displacement Connector, IDC Level

Mini-Tandem Spring Receptacle Contacts — Pages 266-269:

- 108-25031 Tandem Spring Receptacle Contact

Application Specifications describe requirements for using the product in its intended application, and/or crimping information. They are intended for the Packaging and Design Engineers and the Setup person.

Locking Clip Contacts and Housings — Pages 206-209:

- 114-25006 Contact, Locking Clip, .025 [0.64] Square, Application of

Mod. IV Wire-Applied Contacts and Housings — Pages 210-220:

- 114-25003 AMPMODU Mod. IV (Standard Pressure), AMPMODU Mod. IV.V (Intermediate Pressure) and AMPMODU Mod. V (High Pressure) Receptacle Contacts, Application of
- 114-25016 AMPMODU Mod. IV Crimp Pin Contact

Short-Point Wire-Applied Contacts and Housings — Pages 221-224:

- 114-25038 Short-Point Contacts and Housings

AMPMODU MTE Interconnection System — Pages 225-252:

- 114-25026 AMPMODU MTE Interconnection System

AMPMODU MT and Shielded MT Interconnection System — Pages 255-265:

- 114-25032 AMPMODU MT Interconnection System and Shielding Accessories, Application of

AMPMODU Level V, IDC Connectors —

- 114-25020 Interconnection System, IDC Level V, Application of

Mini-Tandem Spring Receptacle Contacts — Pages 266-269:

- 114-25021 Tandem Spring Receptacle Contact, Application of

Note: All part numbers are RoHS compliant.

Technical Documents for Wire-to-Board Products (Continued)

Instruction Sheets provide instructions for assembling or applying the product. They are intended for the Manufacturing Assembler or Operator.

Locking Clip Contacts and Housings — Pages 206-209:

| | |
|----------|--|
| 408-7604 | TE Extraction Tool 91084-1 |
| 408-7606 | TE Locking Clip Contacts and Connectors |
| 408-7627 | TE Hand Crimp Tool 90295-1, 28-30 AWG Wire |
| 408-8547 | TE Hand Crimp Tool 91533-1, 22-26 AWG Wire |
| 408-9388 | TE Hand Crimp Tool 90431-1, 20 AWG Wire |

Mod. IV Wire-Applied Contacts and Housings — Pages 210-220:

| | |
|----------|---|
| 408-4379 | TE PRO-CRIMPER II Hand Tool |
| 408-7935 | AMPMODU Receptacle Connectors with Strain Relief/Pull Tabs |
| 408-8547 | TE Hand Tool 91516-1, 91517-1 and 91541-1 |
| 408-9451 | TE Extraction Tool 843473-1 for AMPMODU Wire-Applied Housings 86308 |
| 408-9453 | TE Extraction Tools 843996 and 843477 for Removing AMPMODU Crimp Snap-In Receptacle Contacts from Wire-Applied Housings |

AMPMODU MTE Interconnection System — Pages 225-252:

| | |
|----------|---|
| 409-5746 | TE Electric Power Unit 931800-1 |
| 409-5832 | MTE Ribbon Cable Terminator 856002-1 |
| 408-6789 | TE Pneumatic Pistol Handle 58075-1 |
| 408-6790 | TE Manual Pistol Handle 58074-1 |
| 408-6919 | AMPMODU MTE Connectors |
| 408-8547 | TE Hand Crimp Tool 91518-1 and 91551-1 |
| 408-9230 | TE Keying Tool 91417-1 |
| 408-9359 | MTE Modular Terminating Head 58336-1 |
| 408-9393 | TE Pneumatic Bench Assy. 58338-1 |
| 408-9407 | TE Hand Crimp Tool 91531-1 and 58342-2 |
| 408-9453 | TE Extraction Tools 843996 and 843477 for Removing AMPMODU Crimp Snap-In Receptacle Contacts from Wire-Applied Housings |
| 408-9515 | Ribbon Cable Notcher 854449-[] |

AMPMODU MT and Shielded MT Interconnection System — Pages 255-265:

| | |
|----------|-----------------------|
| 408-6532 | AMPMODU MT Connectors |
|----------|-----------------------|

AMPMODU Level V, IDC Connectors —

| | |
|----------|----------------------------|
| 408-6843 | TE Extraction Tool 91409-1 |
|----------|----------------------------|

Standard Tandem Spring and Mini-Tandem Spring Receptacle Contacts — Pages 266-269:

| | |
|----------|-------------------------------|
| 408-7909 | TE Hand Crimping Tool 91540-1 |
|----------|-------------------------------|

Note: All part numbers are RoHS compliant.

Level V IDC Connectors, .125 x .125 [3.18 x 3.18] Centerline

Product Facts

- Termination of discrete wire sizes 26-22 AWG [0.12-0.3 mm²] as well as jacketed cable and bonded ribbon cable (conductors separated)
- Connectors stackable end-to-end and side-to-side on .125 [3.18] centers
- Connectors preloaded with insulation displacement receptacle contacts
- Contact design employs dual cantilever beams, redundant insulation displacement slots, built-in post stop and wire support crimp
- Copper alloy contacts are duplex plated
- Snap-on covers with or without cable tie paddles
- Full line of mass termination tooling offers lowest installed costs for most production needs
- Recognized under the Component Program of Underwriters Laboratories Inc.,  File No. E28476
- Certified by Canadian Standards Association,  File No. LR 7189

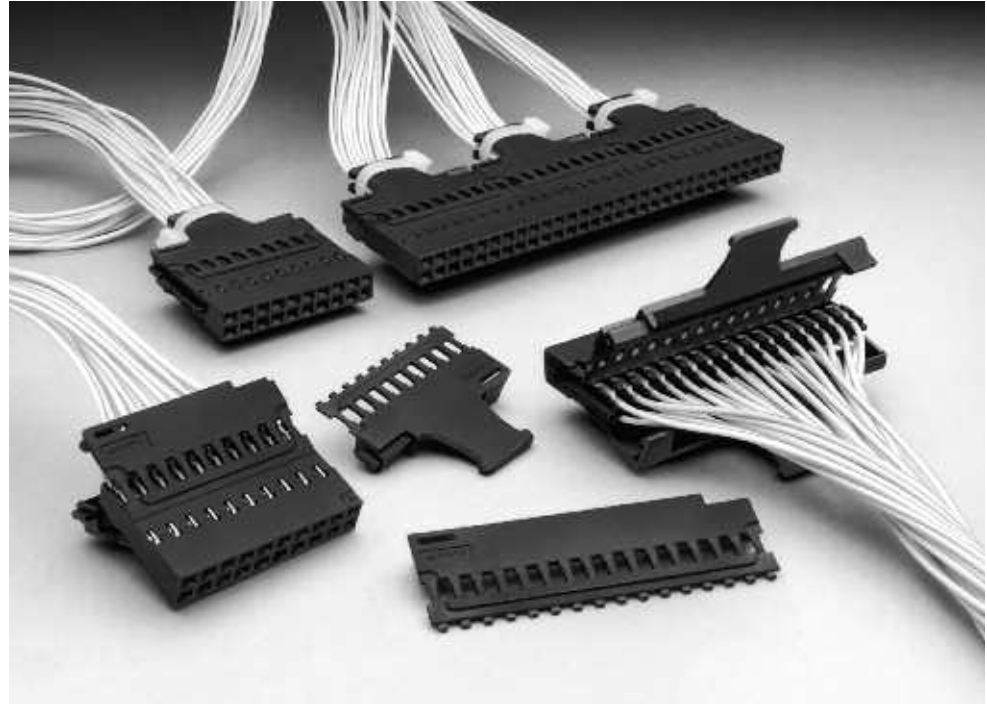

AMPMODU Level V IDC connectors provide cost effective discrete wire connections that are compatible with today's telecommunications packaging techniques. These connectors are designed to mate with .025 [0.64] sq. posts on .125 x .125 [3.18 x 3.18] centers and are comprised of double-row housings preloaded with insulation displacement receptacle contacts, snap-on hermaphroditic covers, and a full line of mass termination tooling to meet virtually every production need. For modular flexibility, connectors can be stacked end-to-end or side-to-side, maintaining a .125 x .125 [3.18 x 3.18] centerline spacing.

Covers can be furnished with and without a cable tie paddle. The covers are simply snapped onto a housing after the connector has been terminated.

The receptacle contacts feature the TE insulation displacement crimp technique for achieving top quality, low cost terminations. These contacts employ dual cantilever beams for redundant interface with a mating post, an integral post stop to limit post mating depth and protect the crimp termination, and a wire support (strain relief) crimp to prevent accidental wire pull-out. The contacts are made of high conductivity copper alloy and are duplex plated.

Performance Characteristics

Contact Current Rating — 3 amperes

Termination Resistance — 12 milliohms (max.)

Durability — Ref. Product Specification 108-25028 (Interconnection System, Insulation Displacement Connector, IDC Level)

Application Specification 114-25020 (Interconnection System, IDC Level V, Application of)

Receptacle Assemblies, Double-Row, .125 x .125 [3.18 x 3.18] Centerline

Housings Preloaded with Insulation Displacement Crimp Receptacle Contacts



Material and Finish

Housing — Black thermoplastic, flame retardant

Contacts — Copper alloy, duplex plated .000050 [0.00127] gold on contact area, .000100 [0.00254] min. tin in crimp area, with entire contact underplated .000050 [0.00127] nickel

Note: Preloaded contacts accept max. insulation dia. of .050 [1.27]. The minimum point of contact, as measured from front edge of housing, is .095 [2.41].

Technical Documents — pages 277, 278

Product Specification
108-25028

Application Specification
114-25020

Receptacle assemblies can be stacked end-to-end and side-to-side on .125 x .125 [3.18 x 3.18] centers.

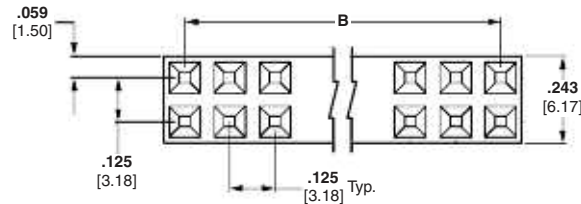
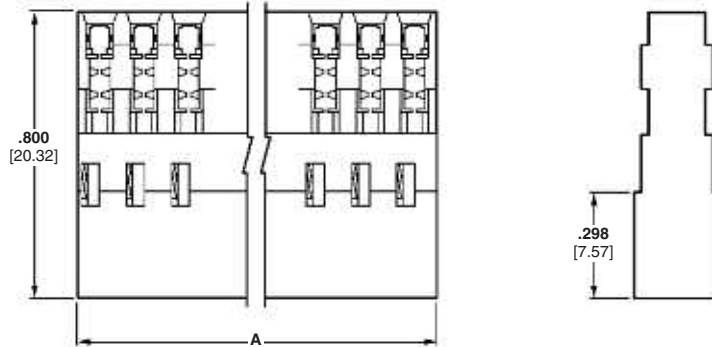

| No. of Pos. | Dimensions | | Receptacle Assembly (Stamped ¹) for 26-22 AWG [0.12-0.3 mm ²] Wire |
|-------------|---------------|---------------|--|
| | A | B | |
| 8 | .493 [12.52] | .375 [9.52] | 102935-4 |
| 10 | .618 [15.70] | .500 [12.70] | 102935-6 |
| 12 | .743 [18.87] | .625 [15.88] | 102935-8 |
| 16 | .993 [25.22] | .875 [22.23] | 1-102935-2 |
| 20 | 1.243 [31.57] | 1.125 [28.58] | 1-102935-6 |
| 24 | 1.493 [37.92] | 1.375 [34.93] | 1-102935-9 |
| 30 | 1.868 [47.45] | 1.750 [44.45] | 1-102935-3 |
| 32 | 1.993 [50.62] | 1.875 [47.63] | 2-102935-8 |
| 40 | 2.493 [63.32] | 2.375 [60.33] | 3-102935-6 |

¹White ink stamped, one side—8- thru 12-position with AMP and arrow; 14- and 16-position with AMP, part no., and arrow; 18- thru 40-position with AMP, part no., date code and arrow.

- Notes:**
- Covers for these housings are shown on pages 281 & 282.
 - Termination tooling for these connectors are shown on page 273-275.
 - 14- and 18-position receptacle assemblies, as well as other sizes, can be made available upon request. Consult TE.

Note: All part numbers are RoHS compliant.

.125 [3.18] x .125 [3.18] Centerline

6

Hermaphroditic Covers for Level V IDC Receptacle Assemblies, Double-Row, .125 x .125 [3.18 x 3.18] Centerline

All covers illustrated here and on the following page can be used on the double-row Level V IDC connectors shown on page 280.

Material

Black thermoplastic, flame retardant, 94V-0 rated

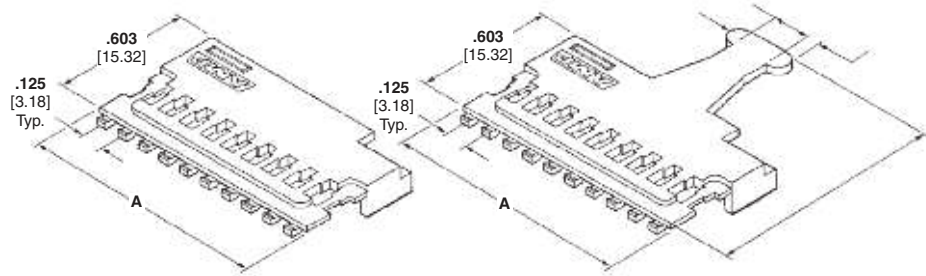

Cover 103056 Series
without Cable Tie Paddle

Cover 103058 Series
with Cable Tie Paddle

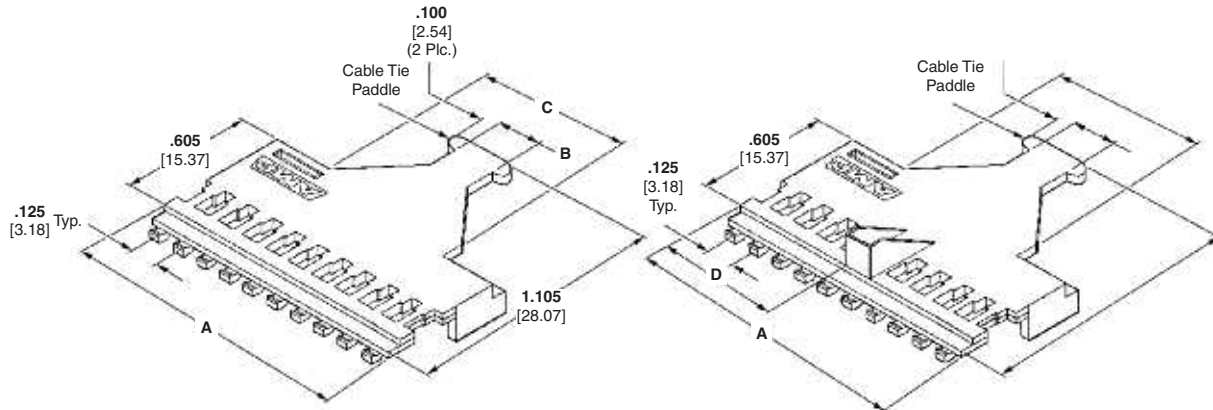

Cover 103349 Series
with Wide Cable Tie Paddle

Cover 103350 Series
with Wide Cable Tie Paddle
and Polarization

| No. of Pos. (Housing Size) | Dimensions | | | | | Cover Part Nos. | | | |
|----------------------------|--|--------------|---------------|---------------|--------------|--------------------------|-----------------------|----------------------------|---|
| | A | B | C | D | E | Without Cable Tie Paddle | With Cable Tie Paddle | With Wide Cable Tie Paddle | With Wide Cable Tie Paddle and Polarization |
| 8 | .491 [12.47] | .150 [3.81] | .285 [7.24] | .166 [4.22] | .125 [3.18] | — | — | 103349-4 | 103350-4 |
| 10 | .616 [15.65] | — | — | — | .125 [3.18] | — | 103058-3 | — | — |
| 12 | .741 [18.82] | — | — | — | .200 [5.08] | — | 103058-4 | — | — |
| 16 | .991 [25.17] | .300 [7.62] | .592 [15.04] | .416 [10.57] | — | — | — | 103349-1 | 103350-1 |
| 20 | 1.241 [31.52] | .300 [7.62] | .592 [15.04] | .541 [13.74] | — | — | — | 103349-5 | 103350-5 |
| 24 | 1.491 [37.87] | — | — | — | .400 [10.16] | 1-103056-0 | 1-103058-0 | — | — |
| 32 | 1.991 [50.57] | .600 [15.24] | 1.312 [33.32] | .916 [23.27] | — | — | — | 103349-2 | 103350-2 |
| 40 | 2.491 [63.27] | .750 [19.05] | 1.820 [46.23] | 1.166 [29.61] | — | — | — | 103349-3 | 103350-3 |
| 64 | See page 282 for Double Cable Tie Paddle versions. | | | | | | | | |

Notes: 1. Two hermaphroditic covers of any style can be installed on a double-row connector housing.
2. Other sizes can be made available upon request.

Note: All part numbers are RoHS compliant.

**Hermaphroditic Covers for Level V IDC Receptacle Assemblies,
Double-Row, .125 x .125 [3.18 x 3.18] Centerline** (Continued)

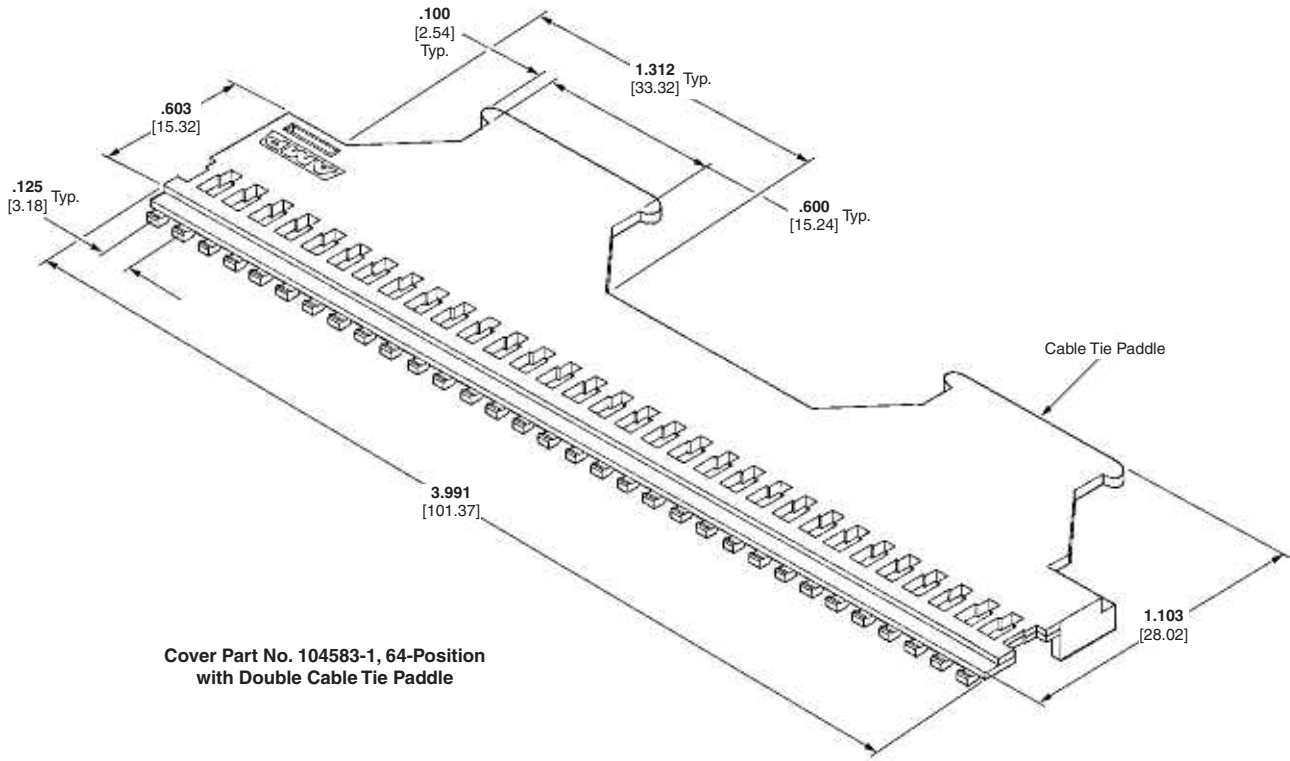

**Cover Part No. 104583-1, 64-Position
with Double Cable Tie Paddle**

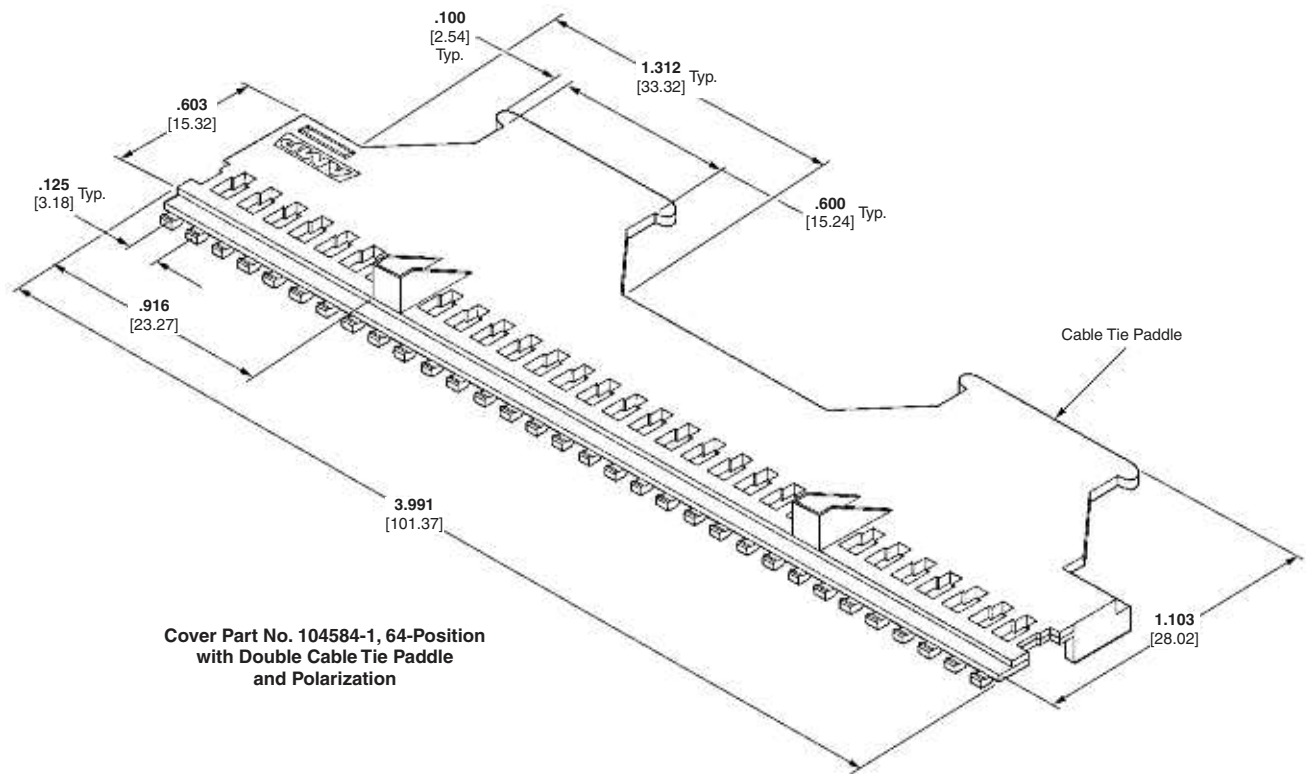



**Cover Part No. 104584-1, 64-Position
with Double Cable Tie Paddle
and Polarization**

Note: All part numbers are RoHS compliant.

.125 [3.18] x .125 [3.18] Centerline
6

AMPMODU .031 x .062 [0.79 x 1.57] Interconnection System

Product Facts

- Rugged connector system featuring .031 x .062 [0.79 x 1.57] posts with mating receptacles
- Current rating 5 amps max per contact. Varies due to ambient temperature, wire size and duty cycles.
- Available for board-to-board and wire-to-board applications
- Posts available on strip for machine application directly to pc board or in housings for board mounting
- Receptacles available for board mounting or wire crimping
- Contacts available in both tin and gold plating
- Flame retardant thermoplastic housings 94V-0 rated
- Locking Clip contacts available to mate with .031 x .062 [0.79 x 1.57] posts
- Recognized under the Component Program of Underwriters Laboratories Inc.,  File No. E28476
- Certified by Canadian Standards Association,  File No. LR 16455

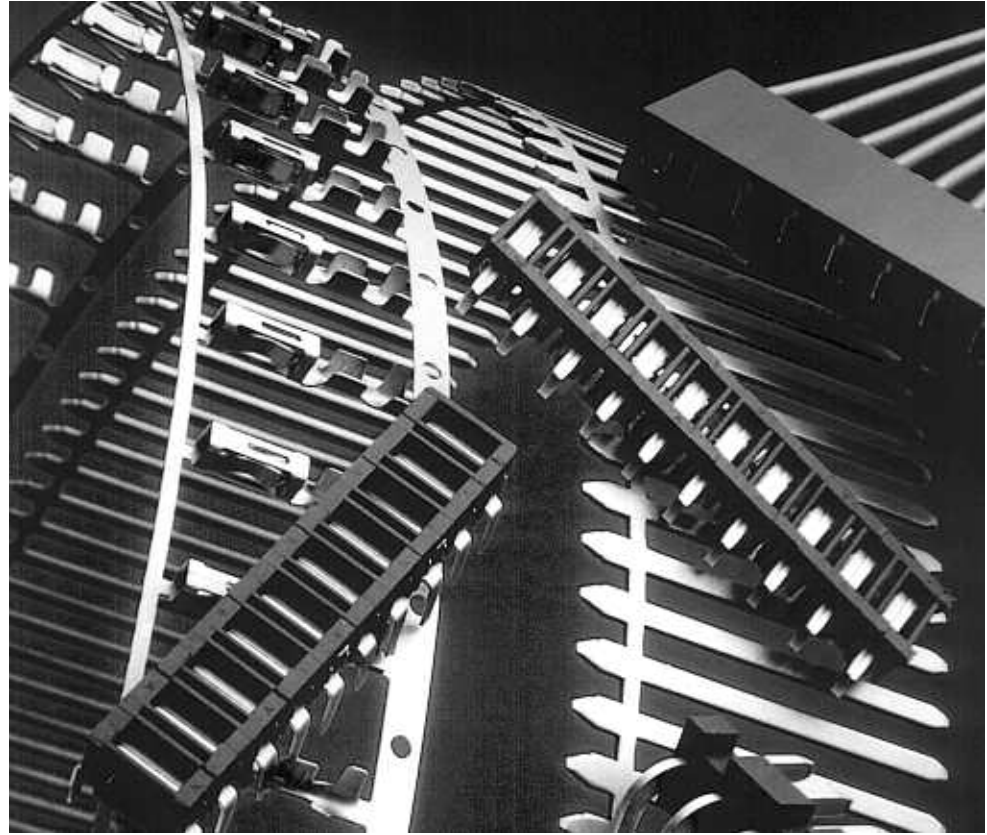

The .031 x .062 [0.79 x 1.57] interconnection system has served as an industry standard for modular packaging for over three decades. It is a rugged, large scale system designed for board-to-board and board-to-wire or cable applications that has offered millions of reliable interconnections and countless mating cycles. This versatile interconnection system successfully meets the requirements for most modular power supply packaging.

Board mounted receptacles and receptacle assemblies are available in various geometries, offering packaging interconnections that include perpendicular, parallel and stacking

capabilities. Machine applied terminations, through matched application equipment, are geared to virtually any production requirement, assuring the lowest possible applied cost.

Crimp snap-in receptacles for 26-18 AWG [0.12 – 0.9mm²] wire provide excellent discrete wire terminations. Housings for these contacts provide for ease of handling terminations in high density applications.

AMPMODU mating posts are supplied typically as header assemblies. They are available in various sizes to meet the interconnection and packaging requirements of your system. However, in instances where packaging

configurations do not lend themselves to the economies of assemblies, TE can provide for the discrete location of individual posts and receptacles.

If your interconnections require Top Entry, Bottom Entry and/or Side Entry for perpendicular, parallel and stacked configurations, the .031 x .062 [0.79 x 1.57] interconnection system can fulfill your needs with the lowest applied cost through efficient interconnections and supporting application equipment.

AMPMODU .031 x .062 [0.79 x 1.57] Interconnection System (Continued)

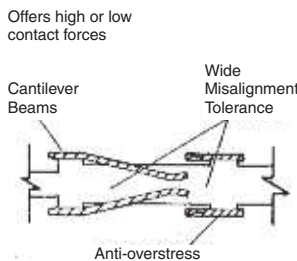
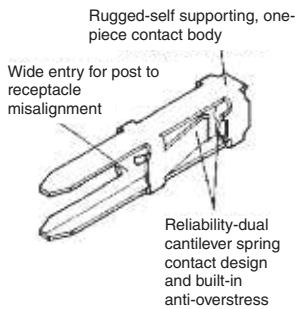
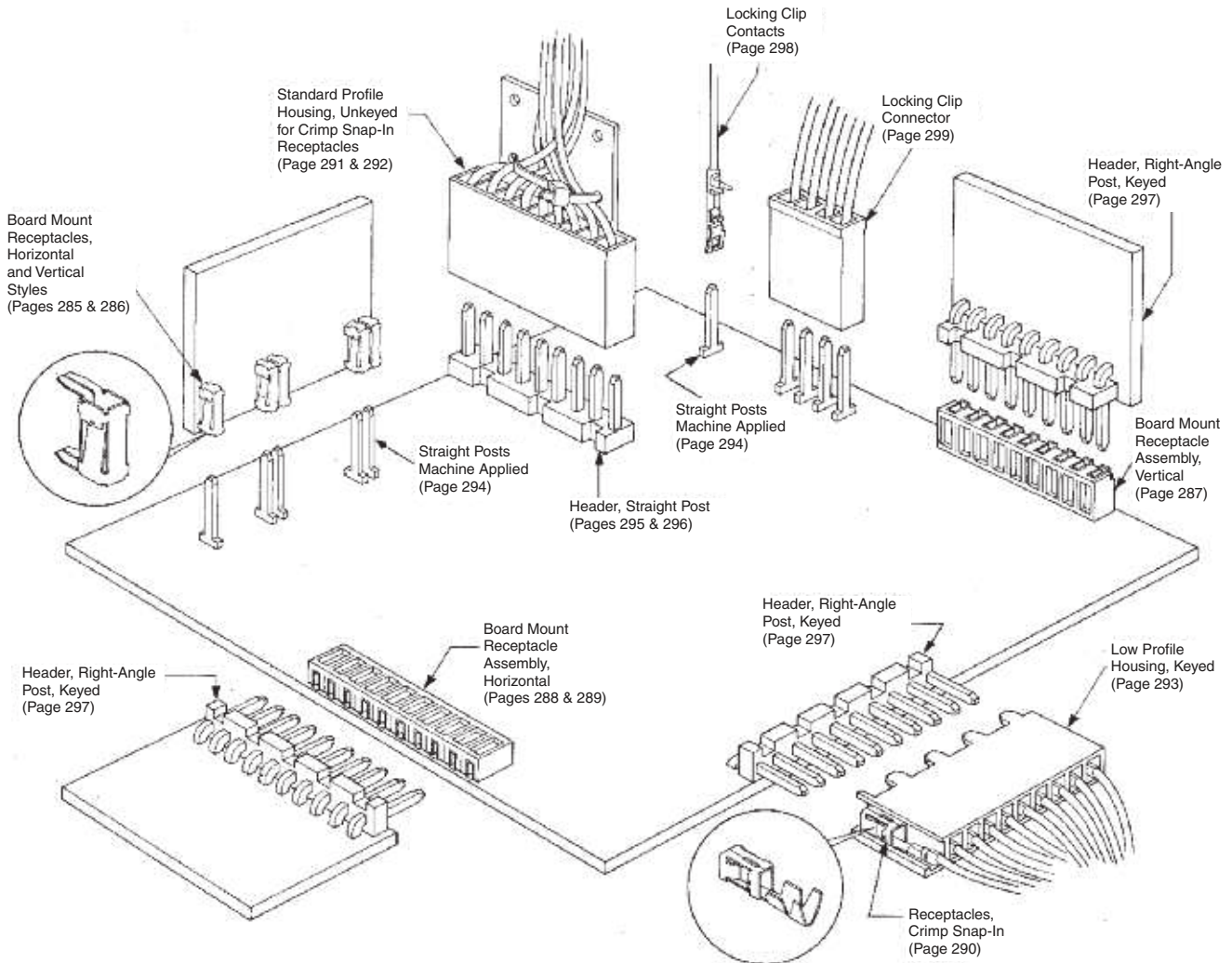

The AMPMODU receptacle cross-section is primarily rectangular, with rounded corners. Two integral cantilever beams contact the mating square or rectangular posts. Deflection of these spring members is limited by anti-overstress and excessive permanent deformation is prevented. This feature allows a wide range of tolerances for misalignment of mating contacts. The configuration of the receptacle completely encloses the spring members preventing damage during handling and assembly and makes the system compatible with automatic application techniques.

This design also permits the use of the receptacles without housings or encapsulation.

Note: Application of a contact lubricant is part of the manufacturing process of all AMPMODU tin-plated crimp products. However, it is not part of the manufacturing process of products that customers will solder, then clean. For these products, TE recommends that customers purchase a contact lubricant. (See application specification 114-25004 for further information.)

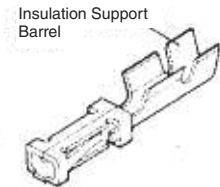

Wire Crimp Receptacle

Mod I Receptacles, Board Mount, .031 x .062 [0.79 x 1.57] Centerline

Vertical and Horizontal Board Mount

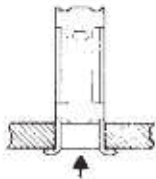

Bottom Post Entry Type A

Top Post Entry Type B

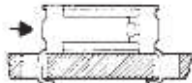
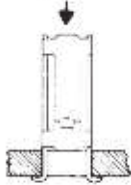

Horizontal Post Entry Type C

Receptacle Styles

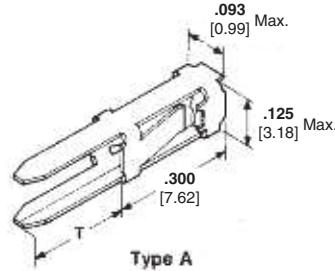

Type A

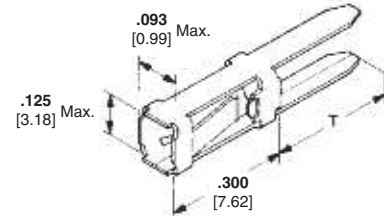

Type B

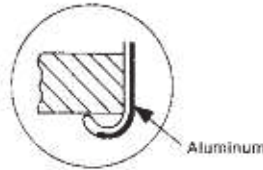

Typical Solder Resist Tab (Type A or B)

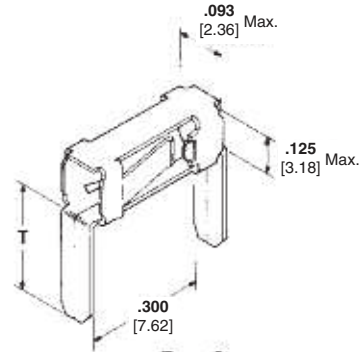

Type C

Related Product Data Recommended Board Layout for Type C — page 288

- Mates with —
- Machine Applied Posts — page 294
- Headers — pages 295-297
- Application Tooling — pages 300-304
- Performance Specifications — page 305
- Technical Documents — page 305

Recommended Board Layout for Receptacle Assemblies and Individual Receptacles (Type A and B)

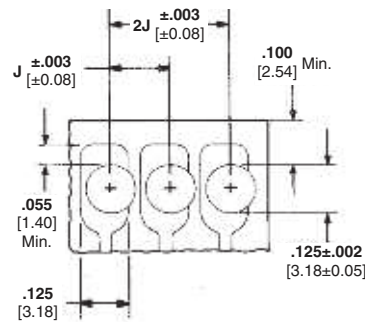

Round Hole (Post Entry Type A or B)

Keying Plug



Part No. 86181-2
Use in Board Mount Receptacles

J-Receptacle centers may vary depending on requirements. For individual receptacles, minimum nominal centerline spacing between adjacent receptacles is .156 [3.81]; for receptacle assemblies, centerline spacing between adjacent receptacles is .156 [3.96]. The .003 [0.08] tolerances are not to accumulate over length of board. For solder mask, see TE Instruction Sheet 408-7411.

Note: Drawings depict normal use of the contact in a one or two-sided circuit board. When using plated thru-holes, refer to TE Engineering Report ER-001 and TE Instruction Sheet 408-7411. For solder mask, see TE Instruction Sheet 408-7411.

Note: All part numbers are RoHS compliant.

Mod I Receptacles, Board Mount, .031 x .062 [0.79 x 1.57] Centerline (Continued)

Material and Finish

Copper alloy, plated as follows:

Plating A — Selectively plated .000030 [0.00076] gold on contact area, with gold flash over .000050 [0.00127] nickel on entire contact

Plating B — .000079 [0.00201] min. tin on entire contact

Plating C — (Solder Resist) — .000030 [0.00076] gold over .000050 [0.00127] nickel on contact area, .000500 [0.01270] aluminum on inside area of solder tines; remainder of contact unfinished

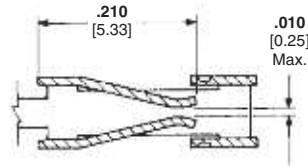

Standard Pressure Receptacle

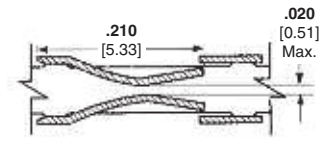

High Pressure Receptacle

| Type | Board Thickness Range | Dimension T (Ref. Pg. 285) | Finish | Standard Pressure Part Nos. | | High Pressure Part Nos. | | Insertion Applicator No. for "U" Frame Machine |
|------|-----------------------|----------------------------|---------------------------|-----------------------------|-------------|-------------------------|-------------|--|
| | | | | Strip Form | Loose Piece | Strip Form | Loose Piece | |
| A | .070-.055 [1.78-1.40] | .112 [2.84] | Plating A | 86477-2 | 86480-2 | — | — | 466376-1 |
| | | | Plating B | 86477-3 | — | 87316-3 | — | 466376-1 |
| | | | Plating C (Solder Resist) | 87772-2 | — | — | — | 466376-1 |
| B | .070-.055 [1.78-1.40] | .112 [2.84] | Plating A | 87003-1 | 87105-1 | — | — | 466376-1 |
| | | | Plating B | 87003-2 | — | — | — | 466376-1 |
| | | | Plating C (Solder Resist) | 87774-2 | — | — | — | 466376-1 |
| C | .103-.055 [2.62-1.40] | .145 [3.68] | Plating A | 85487-4 | 85493-4 | 86432-8 | 86434-6 | 565967-3 |
| | | | Plating B | 85487-3 | — | 86432-1 | 86434-1 | |

Notes: 1. All strip form parts in packaged quantities of 5,000 each.
2. All loose piece parts in packaged quantities of 500 each.

Note: All part numbers are RoHS compliant.

Mod I Receptacle Assemblies, Vertical Board Mount, .031 x .062 [0.79 x 1.57] Centerline

Single Row .156 [3.96] Centerline

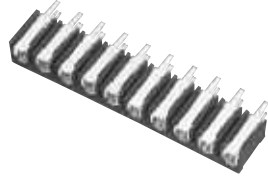

The letter A stamped on contact indicates mating end of receptacle.

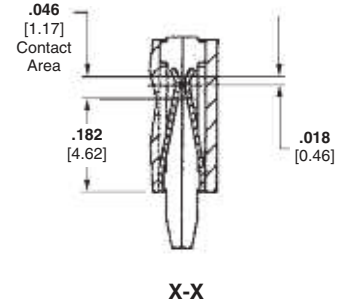
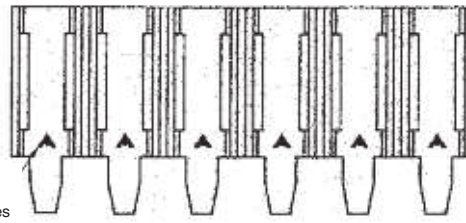

Material and Finish

Housing — Black thermoplastic, 94V-0 rated

Contacts — Copper alloy, plated as follows:

Plating A — Selectively plated .000030 [0.00076] gold on contact area, with gold flash over .000050 [0.00127] nickel on entire contact

Plating B — .000079 [0.00201] min. tin on entire contact

Plating C — (Solder Resist) — .000030 [0.00076] gold over .000050 [0.00127] nickel on contact area, .000500 [0.01270] aluminum on inside area of solder tines; remainder of contact unfinished

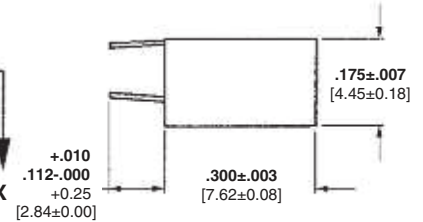
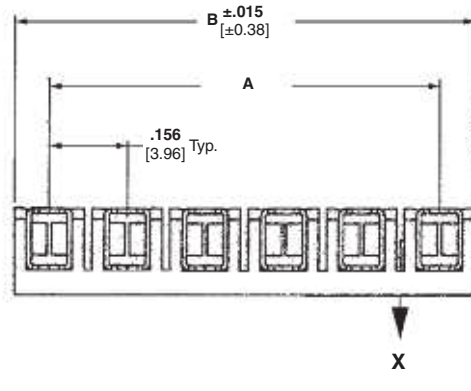

Related Product Data

Recommended Board Layout — page 288

Mates with —

Machine Applied Posts — page 294

Headers — pages 295-297

Performance Specifications — page 305

Technical Documents — page 305

| No. of Pos. | Dimensions | | Type A | | | | Type B | | |
|-------------|---------------|---------------|-------------------|-----------|---------------|-------------------|-----------|-----------|-----------|
| | A | B | Standard Pressure | | High Pressure | Standard Pressure | | | |
| | | | Plating A | Plating B | Plating C | Plating B | Plating A | Plating B | Plating C |
| 2 | .156 [3.96] | .312 [7.92] | 87984-2 | 87983-2 | 87989-2 | 87993-2 | 87986-2 | 87985-2 | 87990-2 |
| 3 | .312 [7.92] | .468 [11.89] | 87984-3 | 87983-3 | 87989-3 | 87993-3 | 87986-3 | 87985-3 | 87990-3 |
| 4 | .468 [11.89] | .624 [15.85] | 87984-4 | 87983-4 | 87989-4 | 87993-4 | 87986-4 | 87985-4 | 87990-4 |
| 5 | .624 [15.85] | .780 [19.81] | 87984-5 | 87983-5 | 87989-5 | 87993-5 | 87986-5 | 87985-5 | 87990-5 |
| 6 | .780 [19.81] | .936 [23.77] | 87984-6 | 87983-6 | 87989-6 | 87993-6 | 87986-6 | 87985-6 | 87990-6 |
| 7 | .936 [23.77] | 1.092 [27.74] | 87984-7 | 87983-7 | 87989-7 | 87993-7 | 87986-7 | 87985-7 | 87990-7 |
| 8 | 1.092 [27.74] | 1.248 [31.70] | 87984-8 | 87983-8 | 87989-8 | 87993-8 | 87986-8 | 87985-8 | 87990-8 |
| 9 | 1.248 [31.70] | 1.404 [35.66] | 87984-9 | 87983-9 | 87989-9 | 87993-9 | 87986-9 | 87985-9 | 87990-9 |
| 10 | 1.404 [35.66] | 1.560 [39.62] | 1-87984-0 | 1-87983-0 | 1-87989-0 | 1-87993-0 | 1-87986-0 | 1-87985-0 | 1-87990-0 |
| 11 | 1.560 [39.62] | 1.716 [43.59] | 1-87984-1 | 1-87983-1 | 1-87989-1 | 1-87993-1 | 1-87986-1 | 1-87985-1 | 1-87990-1 |
| 12 | 1.716 [43.59] | 1.872 [47.55] | 1-87984-2 | 1-87983-2 | 1-87989-2 | 1-87993-2 | 1-87986-2 | 1-87985-2 | 1-87990-2 |
| 13 | 1.872 [47.55] | 2.028 [51.51] | 1-87984-3 | 1-87983-3 | 1-87989-3 | 1-87993-3 | 1-87986-3 | 1-87985-3 | 1-87990-3 |
| 14 | 2.028 [51.51] | 2.184 [55.47] | 1-87984-4 | 1-87983-4 | 1-87989-4 | 1-87993-4 | 1-87986-4 | 1-87985-4 | 1-87990-4 |
| 15 | 2.184 [55.47] | 2.340 [59.44] | 1-87984-5 | 1-87983-5 | 1-87989-5 | 1-87993-5 | 1-87986-5 | 1-87985-5 | 1-87990-5 |
| 16 | 2.340 [59.44] | 2.496 [63.40] | 1-87984-6 | 1-87983-6 | 1-87989-6 | 1-87993-6 | 1-87986-6 | 1-87985-6 | 1-87990-6 |
| 17 | 2.496 [63.40] | 2.652 [67.36] | 1-87984-7 | 1-87983-7 | 1-87989-7 | 1-87993-7 | 1-87986-7 | 1-87985-7 | 1-87990-7 |
| 18 | 2.652 [67.36] | 2.808 [71.32] | 1-87984-8 | 1-87983-8 | 1-87989-8 | 1-87993-8 | 1-87986-8 | 1-87985-8 | 1-87990-8 |
| 19 | 2.808 [71.32] | 2.964 [75.29] | 1-87984-9 | 1-87983-9 | 1-87989-9 | 1-87993-9 | 1-87986-9 | 1-87985-9 | 1-87990-9 |
| 20 | 2.964 [75.29] | 3.120 [79.25] | 2-87984-0 | 2-87983-0 | 2-87989-0 | 2-87993-0 | 2-87986-0 | 2-87985-0 | 2-87990-0 |

Keying Plug



Part No. 86181-2
(Use in Board Mount Receptacles)

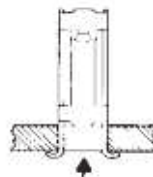

Post Entry Type A

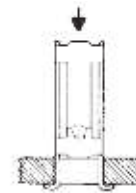

Post Entry Type B

Note: All part numbers are RoHS compliant.

Mod I Receptacle Assemblies, Horizontal Board Mount, .031 x .062 [0.79 x 1.57] Centerline

Single Row .156 [3.96] Centers

Material and Finish

Housing — Black thermoplastic, 94V-0 rated

Contacts — Copper alloy, plated as follows:

Plating A — Selectively plated .000030 [0.00076] gold contact area, with gold flash over .000050 [0.00127] nickel on entire contact

Plating B — .000079 [0.00201] min. tin on entire contact

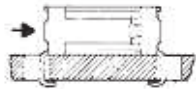

Post Entry Type C

Related Product Data

Mates with —

Machine Applied Posts — page 294

Headers — pages 295-297

Performance Specifications — page 305

Technical Documents — page 305

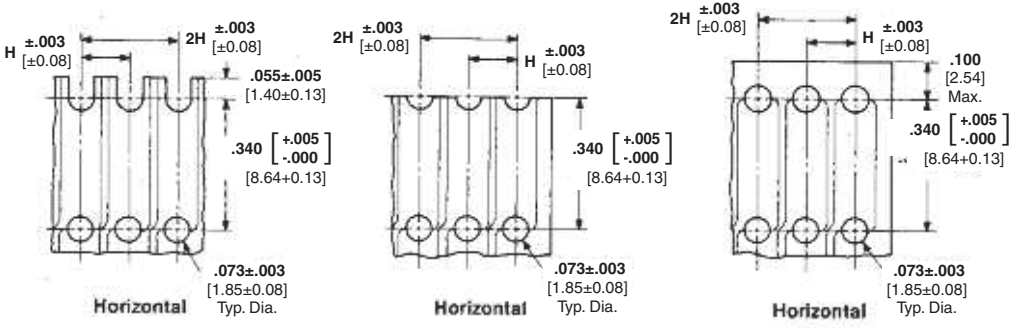
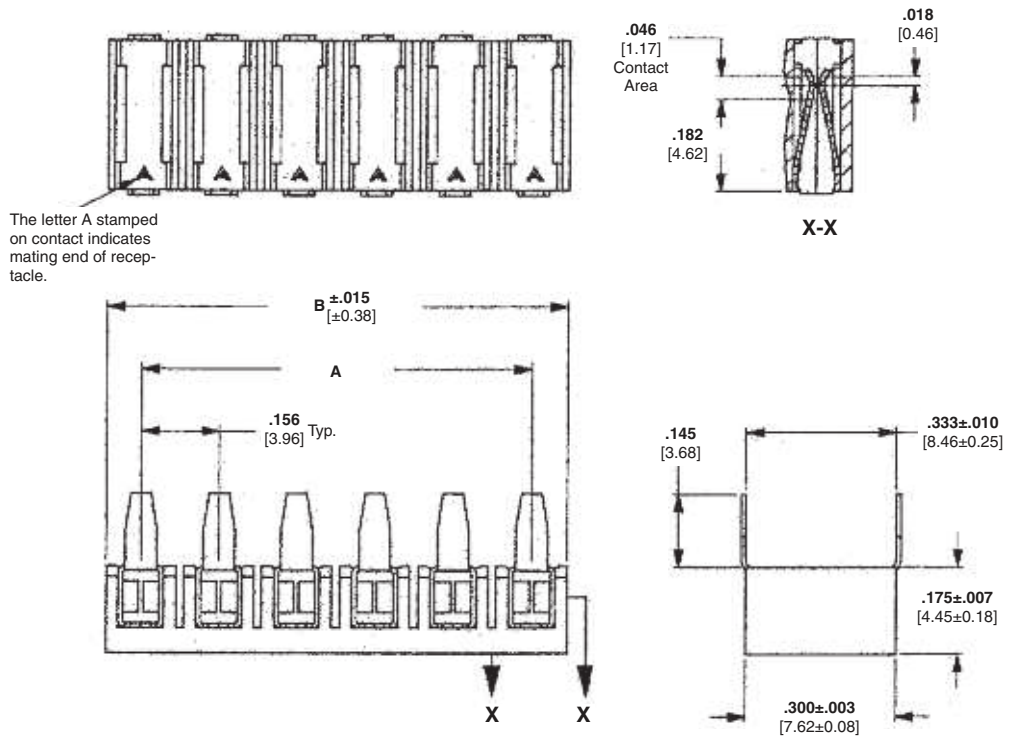

This configuration recommended for use with machine applied posts or headers with a .405 [10.29] minimum mating end post length.*

This configuration recommended for use with machine applied posts or headers with a .345 [18.76] minimum mating end post length.*

This configuration recommended for use with machine applied posts or headers with a .500 [12.70] minimum mating end post length.*

Keying Plug



Part No. 86181-2
(Use in Board Mount Receptacles)

The mating post length is depicted by the A dimension on page 294 (machine applied posts) and the C dimension on pages 295-297 (headers).

H-Receptacle centers may vary depending on requirements. For individual receptacles, minimum nominal centerline spacing between adjacent receptacles is .125 [3.18] for receptacle assemblies, centerline spacing between adjacent receptacles is .156 [3.96]. The .003 [0.08] tolerances are not to accumulate over length of board.

Note: All part numbers are RoHS compliant.

7 Mod I Receptacles, Horizontal Board Mount

**Mod I Receptacle Assemblies, Horizontal Board Mount,
.031 x .062 [0.79 x 1.57] Centerline** (Continued)

| No. of Pos. | Dimensions | | Standard Pressure | | High Pressure Plating B |
|-------------|---------------|---------------|-------------------|-----------|-------------------------|
| | A | B | Plating A | Plating B | |
| 2 | .156 [3.96] | .312 [7.92] | 87988-2 | 87987-2 | 87995-2 |
| 3 | .312 [7.92] | .468 [11.89] | 87988-3 | 87987-3 | 87995-3 |
| 4 | .468 [11.89] | .624 [15.85] | 87988-4 | 87987-4 | 87995-4 |
| 5 | .624 [15.85] | .780 [19.81] | 87988-5 | 87987-5 | 87995-5 |
| 6 | .780 [19.81] | .936 [23.77] | 87988-6 | 87987-6 | 87995-6 |
| 7 | .936 [23.77] | 1.092 [27.74] | 87988-7 | 87987-7 | 87995-7 |
| 8 | 1.092 [27.74] | 1.248 [31.70] | 87988-8 | 87987-8 | 87995-8 |
| 9 | 1.248 [31.70] | 1.404 [35.66] | 87988-9 | 87987-9 | 87995-9 |
| 10 | 1.404 [35.66] | 1.560 [39.62] | 1-87988-0 | 1-87987-0 | 1-87995-0 |
| 11 | 1.560 [39.62] | 1.716 [43.59] | 1-87988-1 | 1-87987-1 | 1-87995-1 |
| 12 | 1.716 [43.59] | 1.872 [47.55] | 1-87988-2 | 1-87987-2 | 1-87995-2 |
| 13 | 1.872 [47.54] | 2.028 [51.51] | 1-87988-3 | 1-87987-3 | 1-87995-3 |
| 14 | 2.028 [51.51] | 2.184 [55.47] | 1-87988-4 | 1-87987-4 | 1-87995-4 |
| 15 | 2.184 [55.47] | 2.340 [59.44] | 1-87988-5 | 1-87987-5 | 1-87995-5 |
| 16 | 2.340 [59.44] | 2.496 [63.40] | 1-87988-6 | 1-87987-6 | 1-87995-6 |
| 17 | 2.496 [63.40] | 2.652 [67.36] | 1-87988-7 | 1-87987-7 | 1-87995-7 |
| 18 | 2.652 [67.36] | 2.808 [71.32] | 1-87988-8 | 1-87987-8 | 1-87995-8 |
| 19 | 2.808 [71.32] | 2.964 [75.29] | 1-87988-9 | 1-87987-9 | 1-87995-9 |
| 20 | 2.964 [75.29] | 3.120 [79.25] | 2-87988-0 | 2-87987-0 | 2-87995-0 |

Note: All part numbers are RoHS compliant.

Mod I Receptacles, Crimp Snap-In (Wire Applied), .031 x .062 [0.79 x 1.57] Centerline

Material and Finish

Copper alloy, plated as follows:

Plating A — Selectively plated .000030 [0.00076] gold on contact area, with gold flash over .000050 [0.00127] nickel on entire contact

Plating B — .000016 [0.00041] min. tin on entire contact

Related Product Data

Housings used in — pages 291-293

Mate with Machine Applied Posts — page 294

Headers — pages 295-297

Application Tooling — page 300-304

Performance Specification — page 305

Technical Documents — page 305

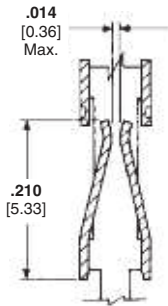
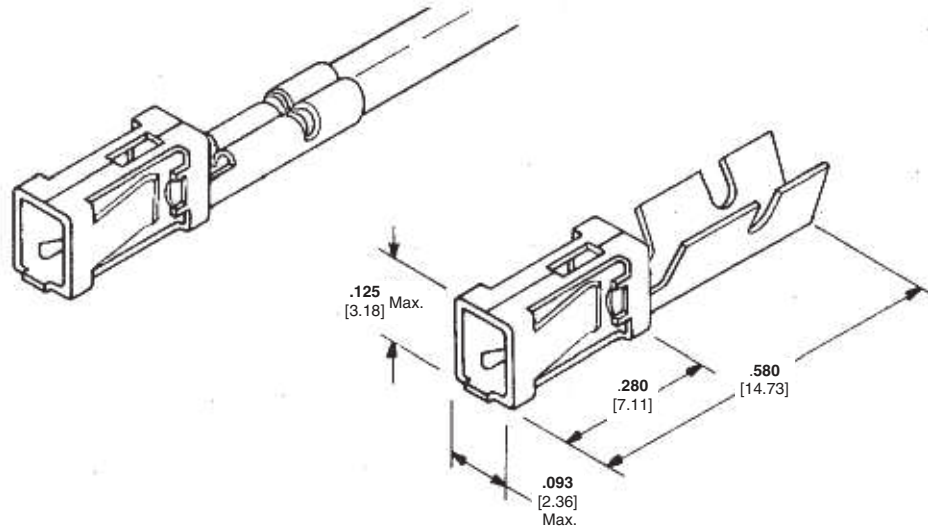

Standard Pressure Receptacle

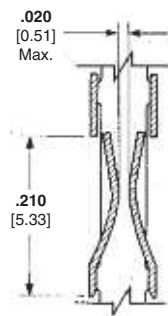

High Pressure Receptacle



Extraction Tool Part No. 843473-1
Part Instruction Sheet 408-9451

| Wire Size Range AWG [mm ²] | Ins. Dia. Range | Finish | Standard Pressure | | | |
|---|-----------------------|-----------|------------------------|--------------|------------------------|--------------|
| | | | Strip Form | | Loose Piece | |
| | | | Packaged Quantities | Part Nos. | Packaged Quantities | Part Nos. |
| 22-18 [0.3-0.9] | .051-.090 [1.30-2.29] | Plating A | 5,000 | 102099-2 | 500 | 102103-2 |
| | | Plating B | 5,000 | 102099-5 | 500 | 102103-3 |

| Wire Size Range AWG [mm ²] | Applicator (Standard Pressure) | | | Premium CERTI-CRIMP Hand Tool Part Number |
|---|--------------------------------|------|--------------------------------|--|
| | Part Number | Type | Used With Machine | |
| 22-18 [0.3-0.9] | 466764-3 | HDM | Model "G" (AMP-O-LECTRIC) | 90274-2 |
| | 466764-2 | HDM | Model "K" (AMP-O-LECTRIC) | |
| | 466764-1 | HDM | CLS IV+ (AMPOMATOR) | |
| | 466937-1 | SCA | Stripper-Crimper (AMP-O-MATIC) | |

AMP-O-LECTRIC KII Machine. Applicators also available for AMPOMATOR Lead Making Machines and Stripper/Crimper Machines. Consult TE.

| Wire Size Range AWG [mm ²] | Ins. Dia. Range | Finish | High Pressure | | | |
|---|-----------------------|-----------|------------------------|--------------|------------------------|--------------|
| | | | Strip Form | | Loose Piece | |
| | | | Packaged Quantities | Part Nos. | Packaged Quantities | Part Nos. |
| 22-18 [0.3-0.9] | .051-.090 [1.30-2.29] | Plating A | 5,000 | 102100-2 | 500 | 102104-2 |
| | | Plating B | 5,000 | 102100-5 | 500 | 102104-3 |
| 26-22 [0.12-0.4] | 0.42-.073 [1.07-1.85] | Plating A | 5,000 | 102102-2 | 500 | 102106-2 |
| | | Plating B | 5,000 | 102102-5 | 500 | 102106-3 |

| Wire Size Range AWG [mm ²] | Applicator (High Pressure) | | | Premium CERTI-CRIMP Hand Tool Part Number |
|---|----------------------------|------|--------------------------------|--|
| | Part Number | Type | Used With Machine | |
| 22-18 [0.3-0.9] | 466764-3 | HDM | Model "G" (AMP-O-LECTRIC) | 90274-2 |
| | 466764-2 | HDM | Model "K" (AMP-O-LECTRIC) | |
| | 466764-1 | HDM | CLS IV+ (AMPOMATOR) | |
| | 466937-1 | SCA | Stripper-Crimper (AMP-O-MATIC) | |
| 26-22 [0.12-0.4] | 466763-2 | HDM | Model "K" (AMP-O-LECTRIC) | 90328-1 |
| | 466763-1 | HDM | CLS IV+ (AMPOMATOR) | |

AMP-O-LECTRIC KII Machine. Applicators also available for AMPOMATOR Lead Making Machines and Stripper/Crimper Machines. Consult TE.

Note: All part numbers are RoHS compliant.

Mod I Receptacle Housings, Standard Profile, Unkeyed, .031 x .062 [0.79 x 1.57] Centerline

Single Row, .156 [3.96] Centers, Without Strain Relief

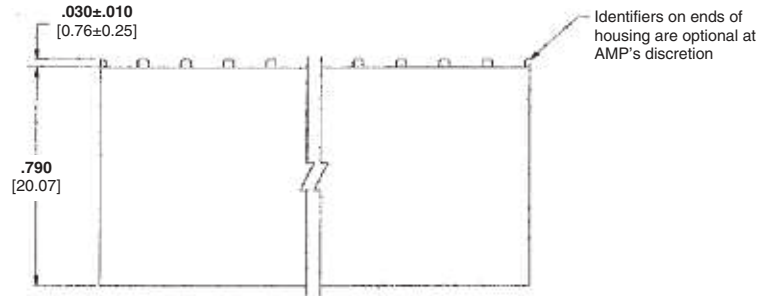
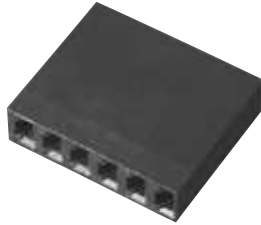

Material

Black thermoplastic, flame retardant, 94V-0 rated

Related Product Data

- Contacts used with — page 290
- Mate with —
- Machine Applied Posts — page 294
- Headers — pages 295-297
- Performance Specifications — page 305

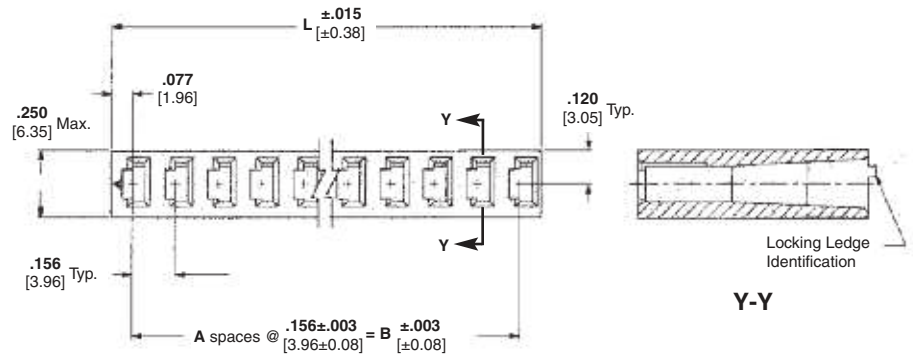

Technical Documents — page 305

| No. of Pos. | Dimensions | | | Housing Part Nos. | |
|-------------|------------|---------------|---------------|----------------------|------------------------|
| | A | B | L | Stamped ¹ | Unstamped ² |
| 2 | 1 | .156 [3.96] | .312 [7.92] | — | 2-87025-5 |
| 3 | 2 | .312 [7.92] | .468 [11.89] | — | 2-87025-1 |
| 4 | 3 | .468 [11.89] | .624 [15.85] | — | 1-87025-3 |
| 5 | 4 | .624 [15.85] | .780 [19.81] | — | 2-87025-3 |
| 6 | 5 | .780 [19.81] | .936 [23.77] | 87025-1 | 87025-2 |
| 7 | 6 | .936 [23.77] | 1.092 [27.74] | — | 3-87025-4 |
| 8 | 7 | 1.092 [27.74] | 1.248 [31.70] | — | 1-87025-6 |
| 9 | 8 | 1.248 [31.70] | 1.404 [35.66] | 87025-9 | 1-87025-0 |
| 10 | 9 | 1.404 [35.66] | 1.560 [39.62] | 1-87025-7 | 1-87025-8 |
| 11 | 10 | 1.560 [39.62] | 1.716 [43.59] | — | 3-87025-6 |
| 12 | 11 | 1.716 [43.59] | 1.872 [47.55] | 1-87025-1 | 1-87025-2 |
| 13 | 12 | 1.872 [47.55] | 2.028 [51.51] | — | 3-87025-0 |
| 14 | 13 | 2.028 [51.51] | 2.184 [55.47] | — | 3-87025-8 |
| 15 | 14 | 2.184 [55.47] | 2.340 [59.44] | — | 3-87025-2 |
| 16 | 15 | 2.340 [59.44] | 2.496 [63.40] | — | 2-87025-0 |
| 17 | 16 | 2.496 [63.40] | 2.652 [67.36] | — | 4-87025-0 |
| 18 | 17 | 2.652 [67.36] | 2.808 [71.32] | — | 87025-4 |
| 19 | 18 | 2.808 [71.32] | 2.964 [75.29] | — | 87025-6 |
| 20 | 19 | 2.964 [75.29] | 3.120 [79.25] | — | 87025-8 |
| 25 | 24 | 3.744 [95.10] | 3.900 [99.06] | — | 5-87025-0 |

Notes: ¹Markings on housing.
²No markings on housing.

Note: All part numbers are RoHS compliant.

**Mod I Receptacle Housings, Standard Profile, Unkeyed,
.031 x .062 [0.79 x 1.57] Centerline** (Continued)

**Single Row, .156 [3.96]
Centers, With Strain Relief**

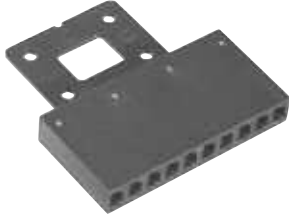

Material

Black thermoplastic, flame retardant,
94V-0 rated

Related Product Data

- Contacts used with** — page 290
- Mate with** —
- Machine Applied Posts** — page 294
- Headers** — pages 295-297
- Performance Specifications** —
page 305

Technical Documents —
page 305

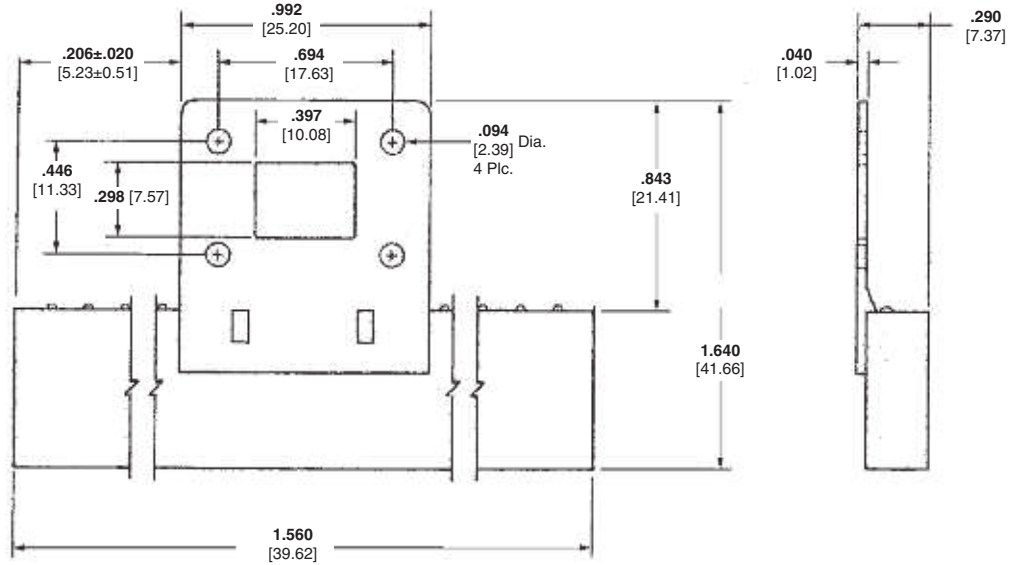

10 Position Receptacle Housing, Part No. 1-102090-0

Note: All part numbers are RoHS compliant.

Mod I Receptacle Housings, Low Profile, Keyed, .031 x .062 [0.79 x 1.57] Centerline

Single Row, .156 [3.96] Centers

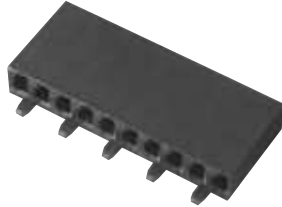

Material

Black thermoplastic, flame retardant, 94V-0 rated

Related Product Data

Contacts used with — page 290

Mate with —

Headers — pages 295-297

Performance Specifications — page 305

Technical Documents —

page 305

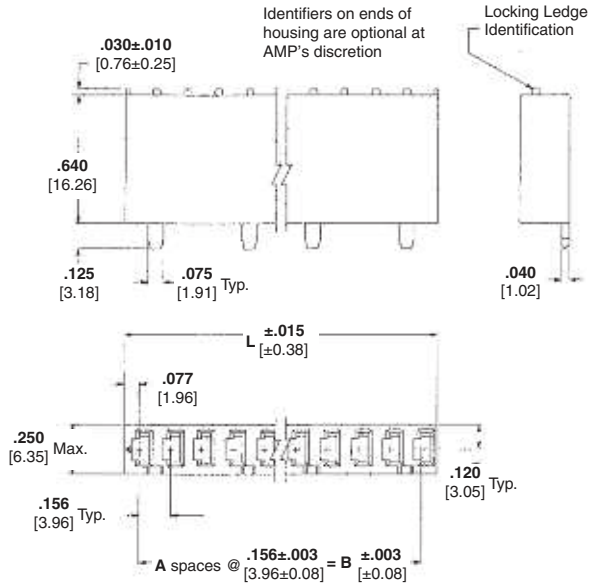

| No. of Pos. | Dimensions | | | No. of Keys | Housing Part Nos. (Unstamped) ¹ | Key Locations |
|-------------|------------|---------------|---------------|-------------|--|-----------------------|
| | A | B | L | | | |
| 2 | 1 | .156 [3.96] | .312 [7.92] | 1 | 87159-3 | A |
| 3 | 2 | .312 [7.92] | .468 [11.89] | 1 | 87159-4 | A |
| 4 | 3 | .468 [11.89] | .624 [15.85] | 2 | 87159-5 | A,C |
| 5 | 4 | .624 [15.85] | .780 [19.81] | 2 | 87159-1 | A,D |
| 6 | 5 | .780 [19.81] | .936 [23.77] | 3 | 87159-6 | A,C,E |
| 7 | 6 | .936 [23.77] | 1.092 [27.74] | 3 | 87159-7 | A,C,E |
| 8 | 7 | 1.092 [27.74] | 1.248 [31.70] | 4 | 87159-8 | A,C,E,G |
| 9 | 8 | 1.248 [31.70] | 1.404 [35.66] | 3 | 87159-9 | A,D,G |
| 10 | 9 | 1.404 [35.66] | 1.560 [39.62] | 5 | 1-87159-0 | A,C,E,G,J |
| 11 | 10 | 1.560 [39.62] | 1.716 [43.59] | 4 | 1-87159-1 | A,D,G,K |
| 12 | 11 | 1.716 [43.59] | 1.872 [47.55] | 6 | 1-87159-2 | A,C,E,G,J,L |
| 13 | 12 | 1.872 [47.55] | 2.028 [51.51] | 4 | 87159-2 | A,D,J,M |
| 14 | 13 | 2.028 [51.51] | 2.184 [55.47] | 7 | 1-87159-3 | A,C,E,G,J,L,N |
| 15 | 14 | 2.184 [55.47] | 2.340 [59.44] | 5 | 1-87159-4 | A,D,G,K,N |
| 16 | 15 | 2.340 [59.44] | 2.496 [63.40] | 8 | 1-87159-5 | A,C,E,G,J,L,N,Q |
| 17 | 16 | 2.496 [63.40] | 2.652 [67.36] | 6 | 1-87159-6 | A,D,G,K,N,R |
| 18 | 17 | 2.652 [67.36] | 2.808 [71.32] | 6 | 1-87159-7 | A,D,F,J,P,S |
| 19 | 18 | 2.808 [71.32] | 2.964 [75.29] | 8 | 1-87159-8 | B,D,F,J,L,N,Q,S |
| 20 | 19 | 2.964 [75.29] | 3.120 [79.25] | 10 | 1-87159-9 | A,C,E,G,J,L,N,Q,S,U |
| 25 | 24 | 3.744 [95.10] | 3.900 [99.06] | 11 | 2-87159-4 | A,C,E,H,K,M,Q,S,U,W,Y |

¹No marking on housing.

Keying Plug

Material — Natural Color Nylon

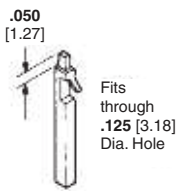

Part No. 87116-2

Keying Plug References

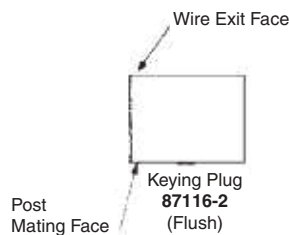

For Standard Housings

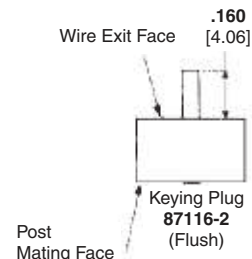

For Low Profile Housings

Note: All part numbers are RoHS compliant.

Mod I Posts, Machine Applied, .031 x .062 [0.79 x 1.57] Centerline

Straight Posts

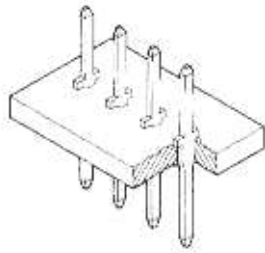

Typical Assembly

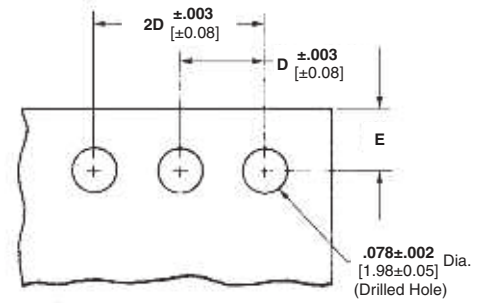
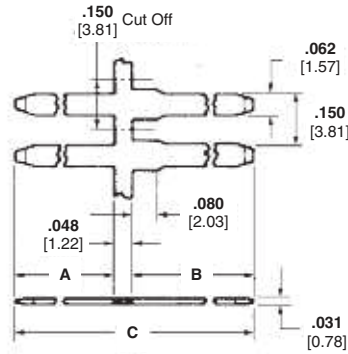

Recommended Mounting Holes

Material and Finish

Brass, plated .000030 [0.00076] gold over .000050 [0.00127] nickel on entire post

Related Product Data

Mate with —

Board Mount Receptacles — pages 285, 286

Board Mount Receptacle Assemblies — pages 287-289

Crimp Snap-In Receptacles and Housings — pages 290-292

Locking Clip Contacts & Housings — pages 298, 299 (see page 298 for recommended post length).

Application Tooling — pages 300-304

Performance Specifications — page 305

Technical Documents — page 305

D—Post centers may vary depending on requirements. Minimum nominal centerline spacing between adjacent contacts is .125 [3.18]; .003 [0.08] tolerances not to accumulate over length of board.
E—Post center location from edge of board may vary to satisfy application.

| A | Dimensions | | Finish | Part Nos. | |
|--------------|-------------|--------------|-----------|-------------------------|--------------------------|
| | B | C | | Strip Form ¹ | Loose Piece ² |
| .360 [9.14] | .187 [4.75] | .595 [15.11] | Plating A | 86147-7 | 86182-7 |
| | | | Plating B | 5086147-2 | 5086182-2 |
| .380 [9.65] | .320 [8.13] | .748 [19.00] | Plating A | 1-86147-5 | 1-86182-5 |
| | | | Plating B | 5086147-9 | 5086182-9 |
| .400 [10.16] | .125 [3.18] | .573 [14.55] | Plating A | 4-86147-2 | 2-86182-9 |
| | | | Plating B | 3-5086147-7 | 2-5086182-5 |
| .480 [12.19] | .187 [4.75] | .715 [18.16] | Plating A | 1-86147-8 | 1-86182-8 |
| | | | Plating B | 2-5086147-2 | 2-5086182-2 |
| .565 [14.35] | .187 [4.75] | .800 [20.32] | Plating A | 86147-8 | 86182-8 |
| | | | Plating B | 5086147-1 | 5086182-1 |
| .800 [20.32] | .150 [3.81] | .998 [25.35] | Plating A | 1-86147-2 | 1-86182-2 |
| | | | Plating B | 1-5086147-0 | 1-5086182-0 |

¹ Packaging quantity of 20,000 per reel.

² Packaging quantity of 1,000 per bag.

Note: Strip form posts applied with Insertion Machine No. 3-457382-1, includes power unit and applicator.

Note: All part numbers are RoHS compliant.

Mod I Headers, Straight Post, Keyed, .031 x .062 [0.79 x 1.57] Centerline

Single Row, .156 [3.96] Centers

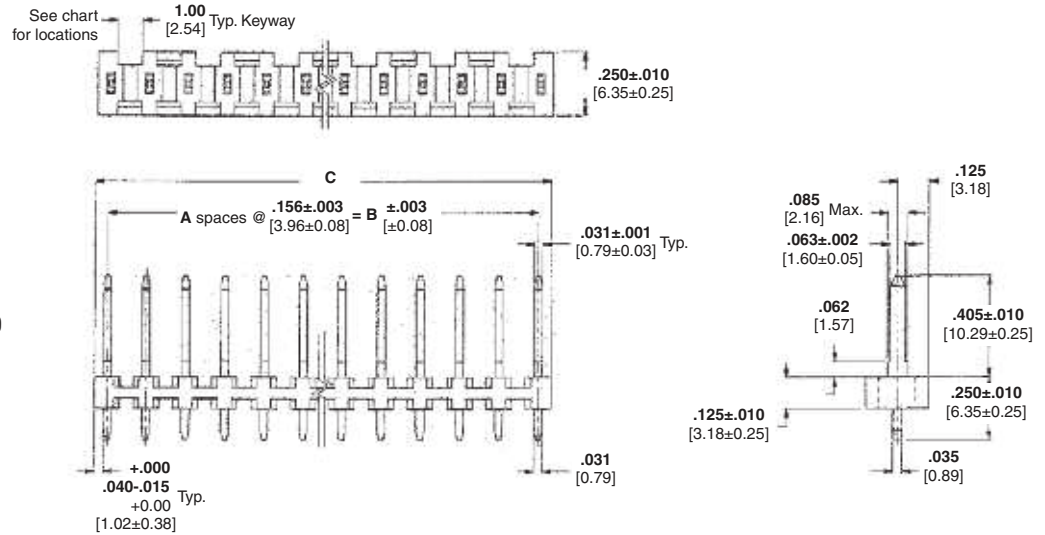
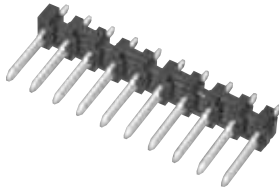

Material and Finish

Housing — Black thermoplastic, 94V-0 rated

Posts — Brass, plated as follows:

Plating A — Selectively plated .000030 [0.00076] gold on contact area, with gold flash over .000050 [0.00127] min. nickel on entire post

Plating B — .000100-.000200 [0.00254-0.00508] tin over .000030 [0.00762] nickel on entire post

Related Product Data

Mate with —

Board Mount Receptacles — pages 285, 286

Board Mount Receptacle Assemblies — pages 287-289

Crimp Snap-In Receptacles and Housings — pages 290-292

Locking Clip Contacts & Housings — pages 298 & 299 (see page 298 for recommended post length).

Performance Specifications — page 305

Technical Documents

page 305

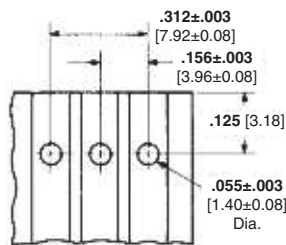

Recommended Board Layout



Keyway Locations (Ref only)

| No. of Pos. | Dimensions | | | No. of Keying Slots | Post Height D=.405 [10.29] | | Post Height D=.587 [14.91] | | Keyway Locations |
|-------------|------------|---------------|---------------|---------------------|----------------------------|-----------|----------------------------|-----------|-------------------------|
| | A | B | C | | Plating A | Plating B | Plating A | Plating B | |
| 2 | 1 | .156 [3.96] | .267 [6.78] | 1 | 85829-2 | 5-87160-4 | 87247-2 | 5-87262-2 | A |
| 3 | 2 | .312 [7.92] | .423 [10.74] | 1 | 85829-3 | 5-87160-5 | 87247-3 | 5-87262-3 | A |
| 4 | 3 | .468 [11.89] | .579 [14.71] | 2 | 85829-4 | 5-87160-6 | 87247-4 | 5-87262-4 | A,C |
| 5 | 4 | .624 [15.85] | .735 [18.67] | 2 | 85829-5 | 5-87160-1 | 87247-5 | 5-87262-5 | A,D |
| 6 | 5 | .780 [19.81] | .891 [22.63] | 3 | 85829-6 | 5-87160-7 | 87247-6 | 5-87262-6 | A,C,E |
| 7 | 6 | .936 [23.77] | 1.047 [26.59] | 3 | 85829-7 | 5-87160-8 | 87247-7 | 5-87262-7 | A,C,E |
| 8 | 7 | 1.092 [27.74] | 1.203 [30.56] | 4 | 85829-8 | 5-87160-9 | 87247-8 | 5-87262-8 | A,C,E,G |
| 9 | 8 | 1.248 [31.70] | 1.359 [34.52] | 3 | 85829-9 | 6-87160-0 | 87247-9 | 5-87262-9 | A,D,G |
| 10 | 9 | 1.404 [35.66] | 1.515 [38.48] | 5 | 1-85829-0 | 6-87160-1 | 1-87247-0 | 6-87262-0 | A,C,E,G,J |
| 11 | 10 | 1.560 [39.62] | 1.671 [42.44] | 4 | 1-85829-1 | 6-87160-2 | 1-87247-1 | 6-87262-1 | A,D,G,K |
| 12 | 11 | 1.716 [43.59] | 1.827 [46.41] | 6 | 1-85829-2 | 6-87160-3 | 1-87247-2 | 6-87262-2 | A,C,E,G,J,L |
| 13 | 12 | 1.872 [47.55] | 1.983 [50.37] | 4 | 1-85829-3 | 5-87160-2 | 1-87247-3 | 6-87262-3 | A,D,J,M |
| 14 | 13 | 2.028 [51.51] | 2.139 [54.33] | 7 | 1-85829-4 | 6-87160-4 | 1-87247-4 | 6-87262-4 | A,C,E,G,J,L,N |
| 15 | 14 | 2.184 [55.47] | 2.295 [58.29] | 5 | 1-85829-5 | 6-87160-5 | 1-87247-5 | 6-87262-5 | A,D,G,K,N |
| 16 | 15 | 2.340 [59.44] | 2.451 [62.26] | 8 | 1-85829-6 | 6-87160-6 | 1-87247-6 | 6-87262-6 | A,C,E,G,J,L,N,Q |
| 17 | 16 | 2.496 [63.40] | 2.607 [66.22] | 6 | 1-85829-7 | 6-87160-7 | 1-87247-7 | 6-87262-7 | A,D,G,K,N,R |
| 18 | 17 | 2.652 [67.36] | 2.763 [70.18] | 7 | 1-85829-8 | 6-87160-8 | 1-87247-8 | 6-87262-8 | A,D,F,J,M,PS |
| 19 | 18 | 2.808 [71.32] | 2.919 [74.14] | 8 | 1-85829-9 | 6-87160-9 | 1-87247-9 | 6-87262-9 | B,D,F,J,L,N,Q,S |
| 20 | 19 | 2.964 [75.29] | 3.075 [78.11] | 10 | 2-85829-0 | 7-87160-0 | 2-87247-0 | 7-87262-0 | A,C,E,G,J,L,N,Q,S,U |
| 21 | 20 | 3.120 [79.25] | 3.231 [82.07] | 7 | 2-85829-1 | 7-87160-1 | 2-87247-1 | 7-87262-1 | A,D,G,K,N,R,U |
| 22 | 21 | 3.276 [83.21] | 3.387 [86.03] | 11 | 2-85829-2 | 7-87160-2 | 2-87247-2 | 7-87262-2 | A,C,E,G,J,L,N,Q,S,U,W |
| 23 | 22 | 3.432 [87.17] | 3.543 [89.99] | 8 | 2-85829-3 | 7-87160-3 | 2-87247-3 | 7-87262-3 | A,D,G,K,N,R,U,X |
| 24 | 23 | 3.588 [91.14] | 3.699 [93.95] | 12 | 2-85829-4 | 7-87160-4 | 2-87247-4 | 7-87262-4 | A,C,E,G,J,L,N,Q,S,U,W,Y |
| 25 | 24 | 3.744 [95.10] | 3.855 [97.92] | 11 | 2-85829-5 | 7-87160-5 | 2-87247-5 | 7-87262-5 | A,C,E,H,K,M,Q,S,U,W,Y |

Note: All part numbers are RoHS compliant.

**Mod I Headers, Straight Post, Keyed,
.031 x .062 [0.79 x 1.57] Centerline** (Continued)

| No. of Pos. | Dimensions | | | No. of Keying Slots | Post Height D=.750 [19.05] | | Post Height D=1.187 [30.15] | | Post Height D=1.310 [33.27] | | Keyway Locations |
|-------------|------------|---------------|---------------|---------------------|----------------------------|-----------|-----------------------------|-----------|-----------------------------|-----------|-------------------------|
| | A | B | C | | Plating A | Plating B | Plating A | Plating B | Plating A | Plating B | |
| | 2 | 1 | .156 [3.96] | | .267 [6.78] | 1 | 85923-2 | 5-85875-7 | 87283-2 | — | |
| 3 | 2 | .312 [7.92] | .423 [10.74] | 1 | 85923-3 | 5-85875-8 | 87283-3 | 5-86207-2 | 85839-3 | 5-85840-3 | A |
| 4 | 3 | .468 [11.89] | .579 [14.71] | 2 | 85923-4 | 5-85875-1 | 87283-4 | 5-86207-9 | 85839-4 | 5-85840-4 | A,C |
| 5 | 4 | .624 [15.85] | .735 [18.67] | 2 | 85923-5 | 5-85875-2 | 87283-5 | 5-86207-3 | 85839-5 | 5-85840-5 | A,D |
| 6 | 5 | .780 [19.81] | .891 [22.63] | 3 | 85923-6 | 5-85875-9 | 87283-6 | — | 85839-6 | 5-85840-6 | A,C,E |
| 7 | 6 | .936 [23.77] | 1.047 [26.59] | 3 | 85923-7 | 6-85875-0 | 87283-7 | — | 85839-7 | 5-85840-7 | A,C,E |
| 8 | 7 | 1.092 [27.74] | 1.203 [30.56] | 4 | 85923-8 | 6-85875-1 | 87283-8 | — | 85839-8 | 5-85840-8 | A,C,E,G |
| 9 | 8 | 1.248 [31.70] | 1.359 [34.52] | 3 | 85923-9 | 5-85875-3 | 87283-9 | — | 85839-9 | 5-85840-9 | A,D,G |
| 10 | 9 | 1.404 [35.66] | 1.515 [38.48] | 5 | 1-85923-0 | 6-85875-2 | 1-87283-0 | — | 1-85839-0 | 6-85840-0 | A,C,E,G,J |
| 11 | 10 | 1.560 [39.62] | 1.671 [42.44] | 4 | 1-85923-1 | 6-85875-3 | 1-87283-1 | — | 1-85839-1 | 6-85840-1 | A,D,G,K |
| 12 | 11 | 1.716 [43.59] | 1.827 [46.41] | 6 | 1-85923-2 | 5-85875-4 | 1-87283-2 | — | 1-85839-2 | 6-85840-2 | A,C,E,G,J,L |
| 13 | 12 | 1.872 [47.55] | 1.983 [50.37] | 4 | 1-85923-3 | 6-85875-4 | 1-87283-3 | — | 1-85839-3 | 6-85840-3 | A,D,J,M |
| 14 | 13 | 2.028 [51.51] | 2.139 [54.33] | 7 | 1-85923-4 | 6-85875-5 | 1-87283-4 | — | 1-85839-4 | 6-85840-4 | A,C,E,G,J,L,N |
| 15 | 14 | 2.184 [55.47] | 2.295 [58.29] | 5 | 1-85923-5 | 6-85875-6 | 1-87283-5 | — | 1-85839-5 | 6-85840-5 | A,D,G,K,N |
| 16 | 15 | 2.340 [59.44] | 2.451 [62.26] | 8 | 1-85923-6 | 6-85875-7 | 1-87283-6 | — | 1-85839-6 | 6-85840-6 | A,C,E,G,J,L,N,Q |
| 17 | 16 | 2.496 [63.40] | 2.607 [66.22] | 6 | 1-85923-7 | 6-85875-8 | 1-87283-7 | — | 1-85839-7 | 6-85840-7 | A,D,G,K,N,R |
| 18 | 17 | 2.652 [67.36] | 2.763 [70.18] | 7 | 1-85923-8 | 6-85875-9 | 1-87283-8 | — | 1-85839-8 | 6-85840-8 | A,D,F,J,M,P,S |
| 19 | 18 | 2.808 [71.32] | 2.919 [74.14] | 8 | 1-85923-9 | 7-85875-0 | 1-87283-9 | — | 1-85839-9 | 6-85840-9 | B,D,F,J,L,N,Q,S |
| 20 | 19 | 2.964 [75.29] | 3.075 [78.11] | 10 | 2-85923-0 | 7-85875-1 | 2-87283-0 | — | 2-85839-0 | 7-85840-0 | A,C,E,G,J,L,N,Q,S,U |
| 21 | 20 | 3.120 [79.25] | 3.231 [82.07] | 7 | 2-85923-1 | 7-85875-2 | 2-87283-1 | — | 2-85839-1 | 7-85840-1 | A,D,G,K,N,R,U |
| 22 | 21 | 3.276 [83.21] | 3.387 [86.03] | 11 | 2-85923-2 | 7-85875-3 | 2-87283-2 | — | 2-85839-2 | 7-85840-2 | A,C,E,G,J,L,N,Q,S,U,W |
| 23 | 22 | 3.432 [87.17] | 3.543 [89.99] | 8 | 2-85923-3 | 5-85875-5 | 2-87283-3 | — | 2-85839-3 | 7-85840-3 | A,D,G,K,N,R,U,X |
| 24 | 23 | 3.588 [91.14] | 3.699 [93.95] | 12 | 2-85923-4 | 7-85875-4 | 2-87283-4 | — | 2-85839-4 | 7-85840-4 | A,C,E,G,J,L,N,Q,S,U,W,Y |
| 25 | 24 | 3.744 [95.10] | 3.855 [97.92] | 11 | 2-85923-5 | 7-85875-5 | 2-87283-5 | — | 2-85839-5 | 7-85840-5 | A,C,E,H,K,M,Q,S,U,W,Y |

Note: All part numbers are RoHS compliant.

Mod I Headers, Right-Angle Post, Keyed, .031 x .062 [0.79 x 1.57] Centerline

Single Row, .156 [3.96] Centers

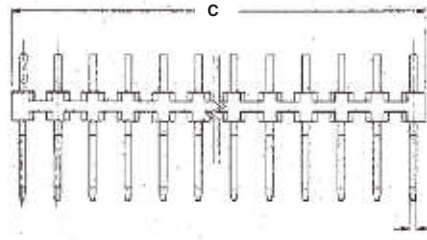
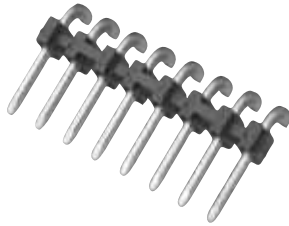

.031±.001
[0.79±0.03] Typ.

Material and Finish

Housing — Black thermoplastic, 94V-0 rated

Posts — Brass, plated as follows:

Plating A — Selectively plated .000030 [0.00076] gold on contact area, with gold flash over .000050 [0.00127] nickel on entire post

Plating B — .000015 [0.00038] gold over .000050 [0.00127] nickel on entire post

Plating C — .00100-.000200 [0.00254-0.00508] tin over .000050 [0.00127] nickel on entire post

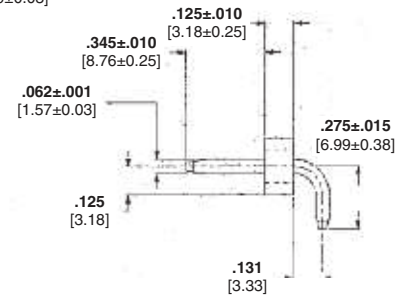
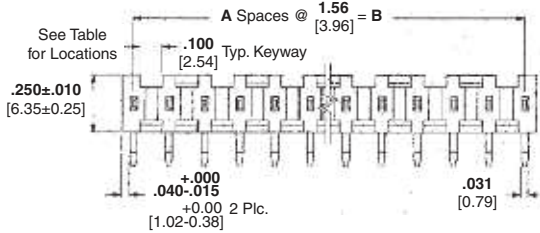

Related Product Data

Mate with —
Board Mount Receptacles — pages 285, 286

Board Mount Receptacle Assemblies — pages 287-289

Crimp Snap-In Receptacles and Housings — pages 290-292

Locking Clip Contacts and Housings — pages 298 & 299 (see page 298 for recommended post length).

Performance Specifications — page 305

Technical Documents — page 305

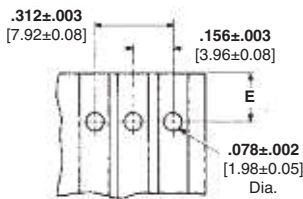

Recommended Board Layout

E Dimension

.345 [8.76] Post Height — .250 [6.35] for mounting header flush with board edge; .595 [15.11] for supporting mating connector on board.

.500 [12.70] Post Height — .250 [6.35] for mounting header flush with board edge; .750 [19.05] for supporting mating connector on board.

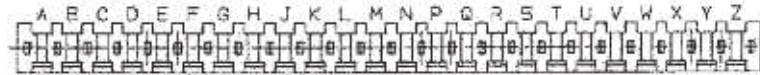

Keyway Locations (Ref Only)

| No. of Pos. | | Dimensions | | | No. of Keying Slots | Post Height D=.345 [8.76] | | Post Height D=.500 [12.70] | | Keyway Locations |
|-------------|----|---------------|---------------|----|---------------------|---------------------------|-----------|----------------------------|-------------------------|------------------|
| | | A | B | C | | Plating A | Plating C | Plating B | Plating C | |
| 2 | 1 | .156 [3.96] | .267 [6.78] | 1 | 87654-2 | 5-87655-2 | 87258-2 | 5-87194-1 | A | |
| 3 | 2 | .312 [7.92] | .423 [10.74] | 1 | 87654-3 | 5-87655-3 | 87258-3 | 5-87194-2 | A | |
| 4 | 3 | .468 [11.89] | .579 [14.71] | 2 | 87654-4 | 5-87655-4 | 87258-4 | 5-87194-3 | A,C | |
| 5 | 4 | .624 [15.85] | .735 [18.67] | 2 | 87654-5 | 5-87655-5 | 87258-5 | 5-87194-4 | A,D | |
| 6 | 5 | .780 [19.81] | .891 [22.63] | 3 | 87654-6 | 5-87655-6 | 87258-6 | 5-87194-5 | A,C,E | |
| 7 | 6 | .936 [23.77] | 1.047 [26.59] | 3 | 87654-7 | 5-87655-7 | 87258-7 | 5-87194-6 | A,C,E | |
| 8 | 7 | 1.092 [27.74] | 1.203 [30.56] | 4 | 87654-8 | 5-87655-8 | 87258-8 | 5-87194-7 | A,C,E,G | |
| 9 | 8 | 1.248 [31.70] | 1.359 [34.52] | 3 | 87654-9 | 5-87655-9 | 87258-9 | 5-87194-8 | A,D,G | |
| 10 | 9 | 1.404 [35.66] | 1.515 [38.48] | 5 | 1-87654-0 | 6-87655-0 | 1-87258-0 | 5-87194-9 | A,C,E,G,J | |
| 11 | 10 | 1.560 [39.62] | 1.671 [42.44] | 4 | 1-87654-1 | 6-87655-1 | 1-87258-1 | 6-87194-0 | A,D,G,K | |
| 12 | 11 | 1.716 [43.59] | 1.827 [46.41] | 6 | 1-87654-2 | 6-87655-2 | 1-87258-2 | 6-87194-1 | A,C,E,G,J,L | |
| 13 | 12 | 1.872 [47.55] | 1.983 [50.37] | 4 | 1-87654-3 | 6-87655-3 | 1-87258-3 | 6-87194-2 | A,D,J,M | |
| 14 | 13 | 2.028 [51.51] | 2.139 [54.33] | 7 | 1-87654-4 | 6-87655-4 | 1-87258-4 | 6-87194-3 | A,C,E,G,J,L,N | |
| 15 | 14 | 2.184 [55.47] | 2.295 [58.29] | 5 | 1-87654-5 | 6-87655-5 | 1-87258-5 | 6-87194-4 | A,D,G,K,N | |
| 16 | 15 | 2.340 [59.44] | 2.451 [62.26] | 8 | 1-87654-6 | 6-87655-6 | 1-87258-6 | 6-87194-5 | A,C,E,G,J,L,N,Q | |
| 17 | 16 | 2.496 [63.40] | 2.607 [66.22] | 6 | 1-87654-7 | 6-87655-7 | 1-87258-7 | 6-87194-6 | A,D,G,K,N,R | |
| 18 | 17 | 2.652 [67.36] | 2.763 [70.18] | 7 | 1-87654-8 | 6-87655-8 | 1-87258-8 | 6-87194-7 | A,D,F,J,M,PS | |
| 19 | 18 | 2.808 [71.32] | 2.919 [74.14] | 8 | 1-87654-9 | 6-87655-9 | 1-87258-9 | 6-87194-8 | B,D,F,J,L,N,Q,S | |
| 20 | 19 | 2.964 [75.29] | 3.075 [78.11] | 10 | 2-87654-0 | 7-87655-0 | 2-87258-0 | 6-87194-9 | A,C,E,G,J,L,N,Q,S,U | |
| 21 | 20 | 3.120 [79.25] | 3.231 [82.07] | 7 | 2-87654-1 | 7-87655-1 | 2-87258-1 | 7-87194-0 | A,D,G,K,N,R,U | |
| 22 | 21 | 3.276 [83.21] | 3.387 [86.03] | 11 | 2-87654-2 | 7-87655-2 | 2-87258-2 | 7-87194-1 | A,C,E,G,J,L,N,Q,S,U,W | |
| 23 | 22 | 3.432 [87.17] | 3.543 [89.99] | 8 | 2-87654-3 | 7-87655-3 | 2-87258-3 | 7-87194-2 | A,D,G,K,N,R,U,X | |
| 24 | 23 | 3.588 [91.14] | 3.699 [93.95] | 12 | 2-87654-4 | 7-87655-4 | 2-87258-4 | 7-87194-3 | A,C,E,G,J,L,N,Q,S,U,W,Y | |
| 25 | 24 | 3.744 [95.10] | 3.855 [97.92] | 11 | 2-87654-5 | 7-87655-5 | 2-87258-5 | 7-87194-4 | A,C,E,H,K,M,Q,S,U,W,Y | |

Note: All part numbers are RoHS compliant.

Locking Clip Contacts for .031 x .062 [0.79 x 1.57] Posts, .031 x .062 [0.79 x 1.57] Centerline

Wire Crimp Contacts with Insulation Support

Material and Finish

Contact Body — Phosphor bronze, plated as follows:

Plating A — Selectively plated .00015 [0.00038] gold on contact area, with gold flash over .000050 [0.00127] nickel on entire post

Plating B — .000100 [0.00254] min. tin over .000050 [0.00127] nickel on entire contact

Contact Spring — Stainless steel

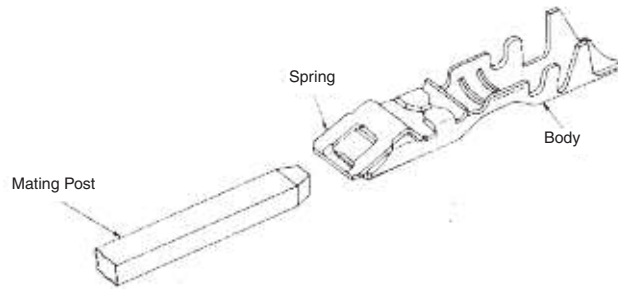

Related Product Data

Mate with —
Machine Applied Posts — page 294
Headers (.500 Post Height Only) — pages 295-297 (see recommended post length below)*

Housings used in — page 299

Application Tooling — pages 300-304

Performance Specification — page 305

Technical Documents — page 305

| Wire Size Range AWG [mm ²] | Ins. Dia. Range | Finish | Contact Part Nos. | |
|---|------------------------|-----------|-------------------|-------------|
| | | | Strip Form | Loose Piece |
| 22-18 [0.3-0.9] | .050-.0100 [1.27-2.54] | Plating A | 87269-2 | 87278-2 |
| | | Plating B | 5-87269-1 | 5-87278-1 |

| Wire Size Range AWG [mm ²] | Applicator | | | Premium CERTI-CRIMP Hand Tool Part Number |
|---|-------------|------|--|---|
| | Part Number | Type | Used With Machine | |
| 22-18 [0.3-0.9] | 466007-2 | HDM | Model "K" (AMP-O-LECTRIC) ¹ | 90308-1 |
| | 466950-2 | SCA | Stripper/Crimper (AMP-O-MATIC) | |

¹AMP-O-LECTRIC KII Machine. Applicators also available for AMPOMATOR Lead Making Machines. Consult TE. **Note:** These contacts must be crimped in accordance with TE Specification No. 114-25008 in order to function properly in a connector housing. Extraction Tool **Part No. 91104-1** is used for removing individual contacts from connector housings and for detaching contacts from mating posts.



Extraction Tool
Part No. 91104-1

Instruction Sheet
408-7678

Wire Harnessing

If necessary, wires can be grouped with cable ties and secured to a panel with fixed clamps. However, locking clip contacts must be free to float within the connector housings to allow proper extraction. Therefore, harnessing hardware or the use of multiple terminations per contact must not restrict the free-floating action of contacts in the housing. For more information, request Insulating and Bundling Products Catalog 124132.

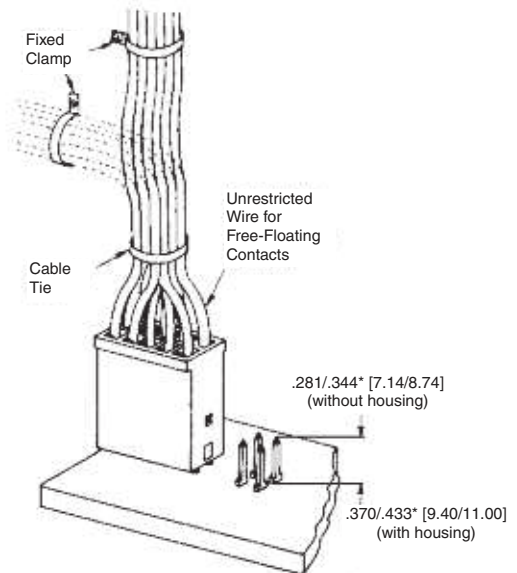

*Dimension defines .031 x .062 [0.79 x 1.57] portion of post. If post is longer than maximum specified, post tip may butt against wire ends.

Note: All part numbers are RoHS compliant.

Locking Clip Connector Housings, .031 x .062 [0.79 x 1.57] Centerline

Single Row, .156 [3.96] Centers

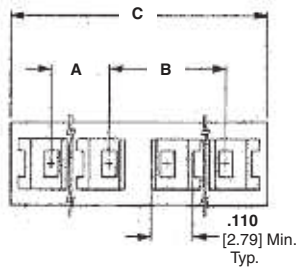

Material and Finish

Black thermoplastic, 94V-0 rated

Related Product Data

Contacts used with — page 298

Mate with —

Machine Applied Posts — page 294

Headers — pages 295-297 (see page 298 for recommended post length)

Performance Specifications — page 305

Technical Documents — page 305

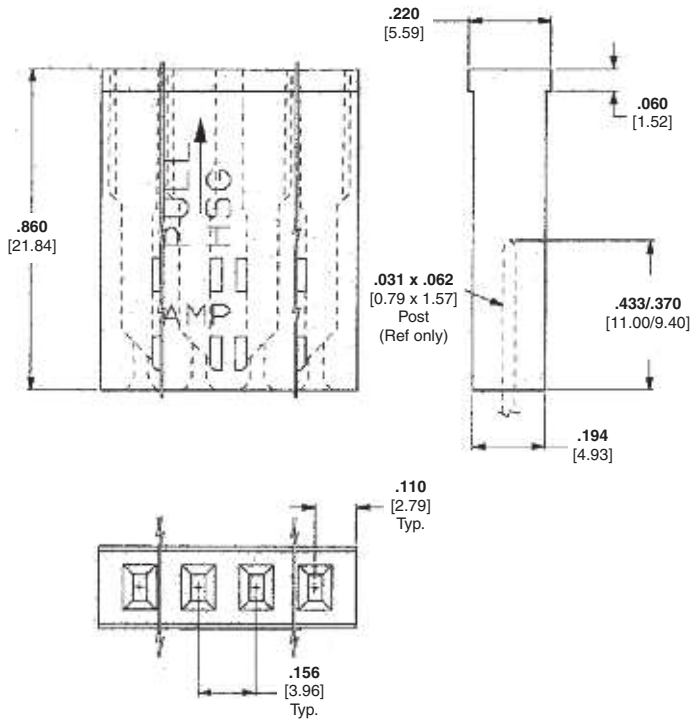

| No. of Pos. | Dimensions | | | Housing Part Nos. | | Keyed Positions on Mating Face |
|-------------|--------------|--------------|---------------|-------------------|-----------|--------------------------------|
| | A | B | C | UnKeyed | Keyed | |
| 1 | — | — | .200 [5.08] | 87270-1 | — | — |
| 2 | — | — | .376 [9.55] | 87270-2 | — | — |
| 3 | .156 [3.96] | .156 [3.96] | .532 [13.51] | 1-87270-3 | — | — |
| 3 of 4 | .156 [3.96] | .312 [7.92] | .688 [17.48] | — | 87270-3 | □□■□ |
| 4 | | | | 87270-4 | — | — |
| 4 of 5 | .312 [7.92] | .312 [7.92] | .844 [21.44] | — | 1-87270-0 | □□□■□ |
| 5 | | | | 1-87270-4 | — | — |
| 5 of 6 | .312 [7.92] | .468 [11.89] | 1.000 [25.40] | — | 1-87270-2 | □□□□■□ |
| 6 | | | | 87270-5 | — | — |
| 6 of 7 | .468 [11.89] | .468 [11.89] | 1.156 [29.36] | — | 1-87270-1 | □□□□■□□ |
| 7 | | | | 1-87270-5 | — | — |
| 8 | .468 [11.89] | .624 [15.85] | 1.312 [33.32] | 87270-6 | — | — |
| 9 | .624 [15.85] | .624 [15.85] | 1.468 [37.29] | 1-87270-6 | — | — |
| 10 | .624 [15.85] | .780 [19.81] | 1.624 [41.25] | 87270-7 | — | — |
| 11 | .780 [19.81] | .780 [19.81] | 1.780 [45.21] | 1-87270-7 | — | — |
| 12 | .780 [19.81] | .936 [23.77] | 1.936 [49.17] | 87270-8 | — | — |

■ Indicates "closed cavity". No post entry hole in this position.

Note: All part numbers are RoHS compliant.

Notes: 1. All housings listed above will accept Locking Clip Contacts No. 87269 and 87278, refer to page 298
2. Refer to TE Instruction Sheet 408-7676 for proper contact orientation within the housings.

Application Tooling

For Crimp Snap-In Receptacles and Locking Clip Contacts

Side-Feed Heavy-Duty Miniature Applicators (Coded HDM)



Interchangeable applicators for crimping products reeled side-by-side on single or dual carrier strips (primarily closed-barrel terminals and open-barrel contacts). Similar design as the end-feed version. All side-feed applicators include a wire stop to help correctly position the wire end in the crimping target area.

For more information, request Instruction Sheet **408-8040**.

AMP-O-LECTRIC Model "G" Terminating Machines, 354500-1, -9, -11



Semiautomatic bench machines for crimping reeled terminals and contacts, featuring a quiet and reliable direct motor drive, microprocessor controls for ease of setup and operation, and guarding and lighting designed for operator convenience and safety. All models are equipped with either manual or automatic precision adjustment of crimp height. Machine-mounted sensors are available for crimp quality monitoring using conventional miniature-style applicators.

Specifications

Width — 18.7-25.3 [475-643] depending on applicator type
Depth — 21.5-28.1 [546-713] depending on applicator type
Height — 20 [508]
Weight — 240 lb [110 kg]
Electrical — 120 or 220 VAC, 50 or 60 Hz; 310 VA
Air — 90-110 psi [6.21-7.59 bar], 6 scfm [0.00282 m³/s] when required with air-feed applicators
Wire Range — 26-10 AWG [0.12-6 mm²] solid or stranded, depending on product applied
 For more information, request Catalog **65828**, Video **198116**, Catalog **82275 [Crimp Quality Monitor (CQM)]**, Video **198094**.

AMPOMATOR CLS IV+ Lead-Making Machines, 356500-1, -2, 1213400-1, -2



Fully-automatic machines that measure, cut, strip and terminate single leads. Microprocessor-controlled, and programmed and operated using an easy-to-follow, menu-driven touchscreen. Features include direct-drive terminating units with precision crimp height adjustment, fully programmable setups, wire runout and splice detection, and motorized pre-feed with wire straightener. Crimp quality monitoring is also available.

Specifications

Width — 159 [4 040]
Depth — 68 [1 730]
Height — 86 [2 185] with 24 [610] dia. reel
Weight — 2 000 lb [907 kg]
Electrical — 220 VAC, 50 or 60 Hz, single phase, 25 A, with neutral and ground
Air — 90 psi [6.21 bar], 15 scfm [0.0071 m³/s] sustained
Wire Range — 26-10 AWG [0.12-6 mm²] stranded, 26-16 AWG [0.12-1.4 mm²] solid
Lead Lengths — 3-90 [76.2-2 285], 90-1 000 [2 285-25 400] with long lead conveyors
 For more information, request Catalog **124324**, Video **198142** (NTSC), **199609** (PAL).

Note: All part numbers are RoHS compliant.

Note: For additional tooling options, contact TE or reference the TE web site.

Application Tooling (Continued)

For Crimp Snap-In Receptacles and Locking Clip Contacts (Continued)

AMP-O-MATIC Stripper-Crimper Machines, 854040-3, -4



Semiautomatic bench crimping machines that also strip the wire, and are therefore used for terminating jacketed cable. Feature manual precision adjustment of crimp height, keyed strip blades for faster, more accurate setups, and an efficient scrap removal system. All adjustments can be made from the front of the machines without special tools. Available with crimp quality monitoring.

Specifications

Width—14 [355]
Depth—18 [457]
Height—33 [838] without reel
Weight—150 lb [68 kg]
Electrical—120 VAC, 50 or 60 Hz, .5 A
Air—80-100 psi [5.52-6.90 bar], 3.5 scfm [0.00165 m³/s]
Wire Range—32-14 AWG [0.03-2 mm²]
 For more information, request Catalog **65004**, Video **198075**, Catalog **82275 [Crimp Quality Monitor (CQM)]**, Video **198094**.

Stripper-Crimper Applicators (coded SCA)

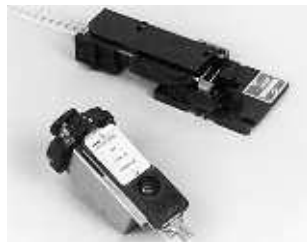

Interchangeable applicators for crimping products in AMP-O-MATIC Stripper-Crimper Machines. Consist of separate ram and lower tooling assemblies. Similar dial-in settings for different wire sizes and insulation diameters as HDM applicators. Available with sensors for use with the Crimp Quality Monitor.

For more information, request Catalog **65004 (AMP-O-MATIC Stripper-Crimper Machines)**, Catalog **82275 [Crimp Quality Monitor (CQM)]**.

Kappa 235, Automatic Cut and Strip, 3-547178-1



The Kappa 235 has the capability of processing wires with a cross section of up to 4 AWG and an outside diameter of 0.59 inch. Options include an inner conductor processing kit for multiconductor cables and a flat ribbon cable kit.

Specifications

Width—25 [630]
Depth—16 [490]
Height—13.4 [370]
Weight—95 lb [44 kg]
Wire Cross-Sections—24-4 AWG [0.22-25 mm²]
Flat Ribbon Cables—width up to 40mm
Length Range—0.04"-328ft [1mm - 99.99m] (+/- 0.2%)
Electrical—110/230 V - 50/60Hz, switches automatically

Cosmic 927R Micro-Cable Stripper



The Cosmic 927R Micro-Cable Stripper was developed to reliably strip various insulation materials and micro-cable. From conductor diameter 36 AWG to 10 AWG, the stripping diameter display can be set to within 0.1mm increments.

Thus optimal stripping quality is guaranteed and damage to the conductor is eliminated.

Note: All part numbers are RoHS compliant.

Note: For additional tooling options, contact TE or reference the TE web site.

Application Tooling (Continued)

For Crimp Snap-In Receptacles and Locking Clip Contacts (Continued)

CERTI-CRIMP Straight Action Hand Tools (SAHT)



Premium grade hand tools. Feature ratchet control to provide complete crimp cycle. Die sets close in a straight line. Include a contact locator and wire stop, plus an insulation crimp adjustment lever, when applicable. Approximate weight 1.3 lb [0.59 kg]

All CERTI-CRIMP head assemblies / dies, have multiple power options available. The accompanying diagram outlines those power options. See catalogs 1654714 (SDE Electric Terminator), 124208 (626 Pneumatic Tool System) and 1773381 (Battery-Powered Crimp Tool Kits) for more information.

For more information, request Catalog **65780**.



PRO-CRIMPER III Hand Tool



Commercial grade hand tool for crimping various products. Features ratchet control to provide complete crimp cycle. Accepts both pinned- and shouldered-style die sets. Locators are provided with pinned-style die sets for proper contact and wire positioning, and to help minimize contact rotation and bending during crimping. Approximate weight 1.3 lb [0.60 kg].

All PRO-CRIMPER head assemblies / dies, have multiple power options available. The accompanying diagram outlines those power options. See catalogs 1654714 (SDE Electric Terminator), 124208 (626 Pneumatic Tool System) and 1773381 (Battery-Powered Crimp Tool Kits) for more information.

Instruction Sheet
408-9930



Note: For additional tooling options, contact TE or reference the TE web site.

Application Tooling (Continued)

For Board Mount Receptacles and Machine Applied Posts

Modular Insertion System (MIS) Bench Machines, 217600 Series, 662820 Series (shown)



For Board Mount Receptacles

Bench machines for inserting a variety of products into pc boards. Uses the same interchangeable insertion heads as the Comp-U-Sertor II Machines. Series 217600 machines feature a manually-operated X-Y positioning fixture, plus a locator spotlight. The machine cycles when the board hole is placed on the anvil and both triggers on the dual handles attached to the X-Y fixture are depressed. Series 662820 machines, without board fixturing, cycle automatically when the hole is properly located. A stabilizing disk over the anvil helps keep the board level.

This benchtop insertion machine installs contacts into PC boards at rates to 2000 per hour. A spotlight highlights the insertion area, and lower tooling assures precise board location. The machine is activated by a foot pedal.

Specifications

- Width** — 18 [457]
 - Depth** — 24 [610]
 - Height** — 18 [457]
 - Weight** — 250 lb [113 kg]
 - Electrical** — 120 to 220 VAC, 50 or 60 Hz (217600); 120 or 240 VAC, 60 Hz, single phase, 120 VA (662820)
 - Air** — 80 psi [5.52 bar] min., 15 scfm [0.00708 m³/s] min.
 - Insertable Area** — 18 x 22 [457 x 559] max.
- For more information, request Catalog **296059**.

P300 Automatic Insertion Machine



Automatic machine for inserting a variety of contacts into pc boards (PCBs). Equipped with an insertion tool (comprised of a product-specific insertion head, an anvil, and a product feed mechanism). Stepper-motor driven X-Y table positions PCBs under insertion head. Surface Mount Equipment Manufacturers Association (SMEMA) compatible inline PCB Insertion Station for posts, tabs, receptacles or sockets. Stand-alone unit is field upgradeable to Pass Through. Mounts up to four TE pneumatic insertion heads. Modem diagnostics standard, vision system optional. Control panel used to program and monitor entire insertion process.

Specifications

- Width** — 57.5 [1 460]
 - Depth** — 64.5 [1 640]
 - Height** — 60 [1 520]
 - Weight** — Depending on configuration
 - Electrical** — 110 V, 60 Hz
 - Air** — 87 psi [6 bar]
 - Insertable Area** — 24 x 16 [600 x 400]
- For more information, contact TE.

Note: All part numbers are RoHS compliant.

Note: For additional tooling options, contact TE or reference the TE web site.

Application Tooling (Continued)

For Board Mount Receptacles and Machine Applied Posts (Continued)

P350 Pin Insertion Machine



The P350 is a fully automatic inline pin insertion machine capable of applying reeled pins, tabs, receptacles and similar products into PCBs. With inline operation, an automatic tool changer and insertion rates up to 5 per second, it is focused at fully automatic high speed operation to maximize throughput while minimizing costly scrap.

A servo powered XY table positions the PCB under a central drive station at high speed. The tool changer can hold up to 3 insertion heads each capable of applying a different product. A unique rotary insertion finger allows the application of products at up to 7 different angles without rotating the PCB. This allows the P350 to apply product at different angles without a reduction in insertion rate or the potential positioning error associated with PCB rotation. Icon driven software with touch screen provides a simple to use, intuitive operator interface.

The P350 provides a wide range of solutions for pin insertion applications. Quick change tooling packs, and a wide range of options make it a flexible high speed platform.

Specifications

Width — 102 [2600]

Depth — 118 [3000]

Height — 87 [2200]

Weight — approx 3500 lb [1600 kg]

Electrical — 230 V, 50-60 Hz, 10 A

Air — 600 kPa dried air

Max. Board Size — 17.5 x 17.5 [450 x 450]

Performance Specifications

The electrical, mechanical and environmental characteristics of the AMPMODU .031 x .062 [0.79 x 1.57] Interconnection System are listed below:

Mechanical Characteristics

Contact Durability

| Plating | Receptacles | | Locking Clip Contacts |
|----------------------------|-------------------|---------------|-----------------------|
| | Standard Pressure | High Pressure | |
| .000016 [0.00041] Min. Tin | 75 Cycles | 25 Cycles | N/A |
| .000079 [0.00201] Min. Tin | 75 Cycles | 25 Cycles | N/A |
| .000100 [0.00254] Min. Tin | N/A | N/A | 25 Cycles |
| .000015 [0.00038] Gold | 75 Cycles | 50 Cycles | 25 Cycles |
| .000030 [0.00076] Gold | 200 Cycles | 100 Cycles | N/A |

Electrical Characteristics

Contact Current Rating —

5 amperes max. for single contact in free air, could vary due to ambient temperature, wire size and duty cycles.

Contact Resistance —

12 milliohms at 100 ma and 50 mv open circuit.

Dielectric Rating —

At Sea Level – 1200 VAC between contacts on .156 [3.96] centers for 1 minute.

Insulation Resistance — 5 x 10³ megohms (initial)

Connector Durability

Receptacles

Mating – 16 oz. [4.45N] max. per contact after 3 mating cycles (standard pressure)

–30 oz. [8.34N] max. per contact after 3 mating cycles (high pressure, gold)

–60 oz. [16.68N] max. per contact after 3 mating cycles (high pressure, tin)

Unmating – 1 oz. [0.28N] min. per contact after 3 mating cycles (standard pressure)

3 oz. [0.83N] min. per contact after 3 mating cycles (high pressure)

Locking Clip Contacts

Mating – 4 lb. [17.79N] max. per contact after 3 mating cycles

Unmating – 2 lb. [8.90N] min. per contact after 3 mating cycles

Environmental Characteristics

Operating Temperature — -65°C to 105°C [-85°F to 221°F] (Gold Plated)

-65°C to 60°C [-85°F to 140°F] (Tin Plated)

Technical Documents

Various technical documents are available for your use:

Product Specifications

describe technical performance characteristics and verification tests. They are intended for the Design, Component and Quality Engineer.

108-25016 Interconnection System, Standard Pressure

108-25025 Interconnection System, High Pressure, Gold

108-25025-1 Interconnection System, High Pressure, Tin

108-36029 Locking Clip Connectors

Application Specifications

describe requirements for using the product in its intended application and/or crimping information. They are intended for the Packaging and Design Engineer and the Machine Setup Person.

114-25000 Crimp Snap-In Receptacle Contacts

114-25004 Board Mount Receptacle Contacts

114-25008 Locking Clip Contacts

114-25011 Machine Applied Straight Posts

Instruction Sheets provide instructions for assembling or applying the product. They are intended for the Manufacturing Assembler or Operator.

408-7308 Clinching Procedures for Header Assemblies

408-7411 Suggestions for Wave Soldering AMPMODU Receptacles

408-7594 TE Hand Tool 90274-2 for Crimping Crimp Snap-In 18-22 AWG Contacts

408-7750 TE Hand Tool 90328-1 for Crimping Crimp Snap-In Contacts (22-26 AWG)

408-7676 AMPMODU Locking Clip Connectors and Contacts

408-7671 TE Hand Tool 90308-1 for Crimping Locking Clip Contacts

408-7678 TE Extraction Tool 91104-1 for Locking Clip Contacts

408-7981 Clinching Procedures for Receptacle Assemblies

408-9451 TE Extraction Tool 843473-1 for Crimp Snap-In Receptacles

Note: All part numbers are RoHS compliant.

Shunts

Product Facts

- 7600 Series Programmable Shunts use conventional .100 x .300 [2.54x7.62] DIP leg spacing
- Post Shunts are used to common pairs of .025 [0.64] square posts, .025 [0.64] diameter round posts and .022 x .026 [0.56 x 0.66] formed posts

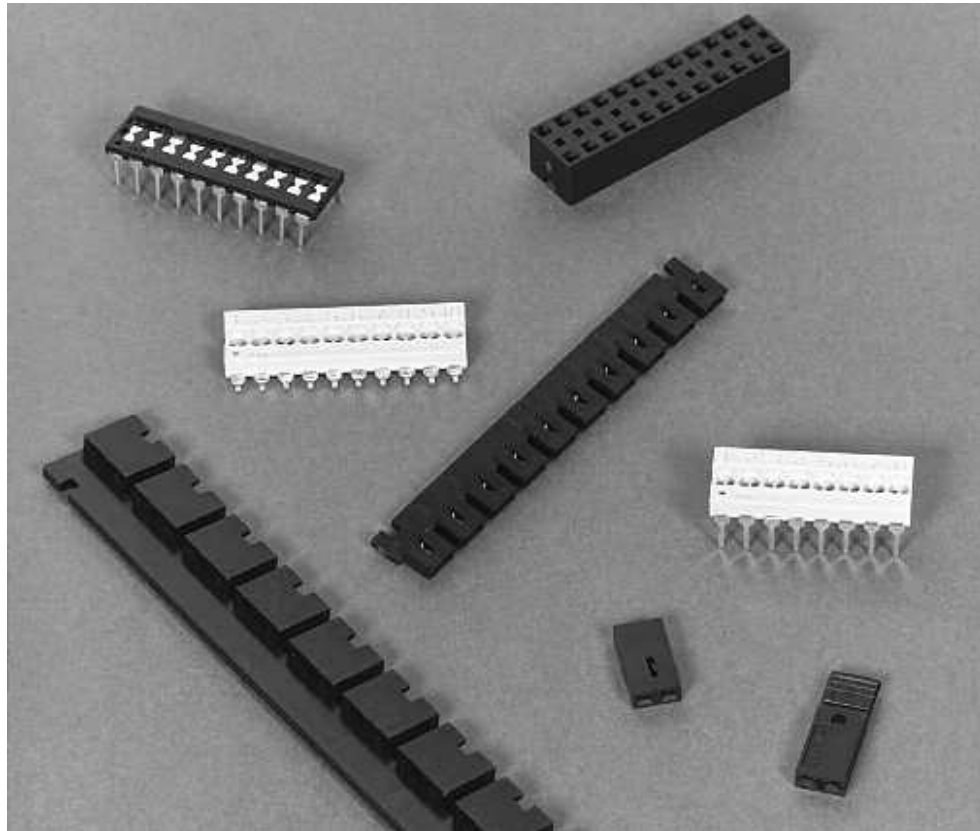

TE offers a variety of high quality shunts for low cost manual programming. TE 7600 Series Programmable Shunts are designed on the standard .100 x .300 [2.54 x 7.62] DIP spacing.

TE DIP Shunts are a highly reliable, low cost means of manually programming various types of electrical/electronic equipment. The shunt consists of a series of conductive straps packaged in a DIP configuration. The straps can be retained intact for a closed circuit or broken with a hand tool to produce an open circuit.

TE Post Shunts mate with any common pairs of square, rectangular and round posts. Post shunts come in two-position low profile, 2 mm miniature, tandem spring, dual beam, and multiposition versions.

Among the options available are choices of gold or tin plating, beryllium copper or phosphor bronze contact material and shunts with 94V-0 rated housing spaces on .079 [2.00], .100 [2.54] and .200 [5.08] centers with the low profile series requiring only .250 [6.35] clearance from the pc board.

All TE shunts feature one-piece construction for high reliability. All have high normal forces for excellent electrical continuity. For added reliability, Tandem Spring and Dual Beam Shunts have two points of contact in each receptacle.

Dual In-Line Package (DIP) Shunts — 7600 Series

Standard Shunt Standard Pressure

Material and Finish

Housing — Glass-filled polyester, UL 94V-0 rated

Contacts — Brass

Finish — Selectively plated .000100 min. tin on solder area over .000050 min. nickel on entire contact

Contact Lead Spacing — .100 x .300 [2.54x7.62]

Lead Length — .140 [3.56] below mounting surface

Housing Color — Black

Programming Tool — See below

Programming Hand Tool

Part No. 435862-1



This tool provides a reliable means of programming DIP shunts. It is rugged, light-weight and dependable. No special skills are required to use this tool.

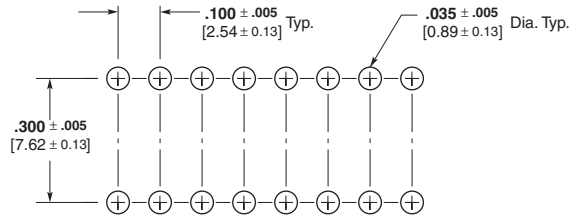
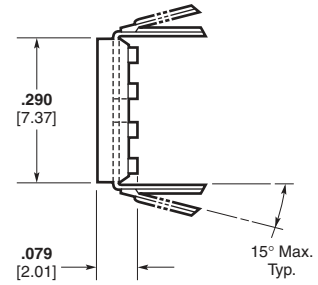
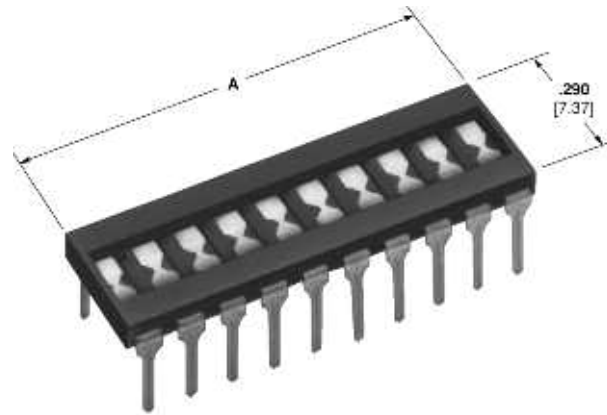

| No. of Pos. | Dimension A | | Standard Shunt Standard Pressure |
|-------------|-------------|-------|----------------------------------|
| | inch | mm | |
| 4 | .400 | 10.16 | 1825190-4 |
| 6 | .600 | 15.24 | 1825190-6 |
| 7 | .700 | 17.78 | 1825190-7 |
| 8 | .800 | 20.32 | 1825190-8 |
| 9 | .900 | 22.86 | 1825190-9 |
| 10 | 1.000 | 25.40 | 1-1825190-0 |
| 12 | 1.200 | 30.48 | 1-1825190-2 |

Note: All part numbers are RoHS compliant.

Post Shunts

Product Facts

- One-piece contact construction
- High normal forces
- 94V-0 rated housings
- Gold inlay, gold plate or tin plate over nickel
- Stackable
- Those post shunts indicated are recognized under the component program of Underwriters Laboratories Inc., File No. E28476 and certified by the Canadian Standards Association File No. LR 7189



2-Position, Low Profile Shunts

Economy Shunt
.100 [2.54] Centerline

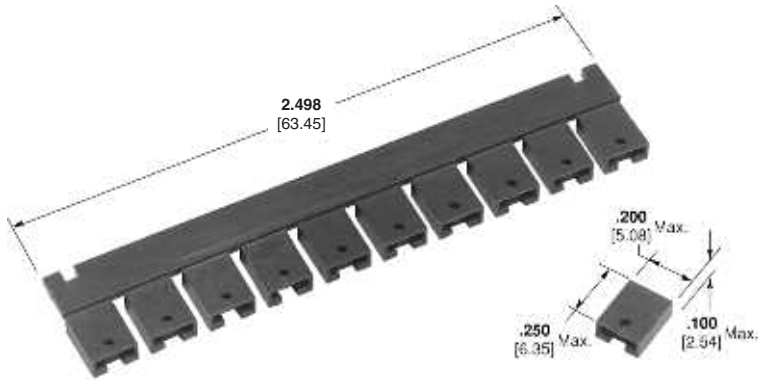

| Configuration | Housing Color | Part Numbers | | | |
|---------------|---------------|---|---|-----------------------------------|------------------------------------|
| | | Gold Plate ¹ .000015 [0.00038] | Gold Flash ¹ .000005 [0.00013] | Tin Plate .000100 [0.00254] | Gold Plate .000030 [0.00076] |
| Strip of 10 | Blue | 382811-2 | — | — | — |
| Strip of 10 | Black | 382811-6 | 382811-8 | 382811-5 | 2-382811-0 |
| Strip of 10 | Red | 382811-9 | — | — | — |
| Loose Piece | Black | 1-382811-6 | 1-382811-8 | — | — |

¹In contact area

Tandem Spring Shunts

- Two points of contact provide extra reliability
- Shunts accept posts as short as .175 [4.45]; posts bottom at .330 [8.38]

2mm Mini Shunts

- Stackable on 2mm contact centerline
- Low profile
- Available in strips of 10

Standard Housing Shunt
.200 [5.08] Centerline

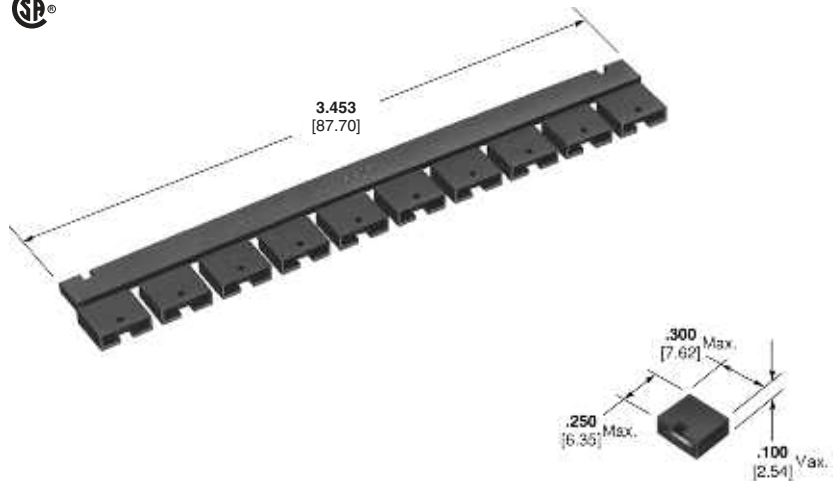

| Configuration | Housing Color | Part Numbers | | |
|---------------|---------------|---|---|-----------------------------------|
| | | Gold Plate ¹ .000015 [0.00038] | Gold Plate ¹ .000030 [0.00076] | Tin Plate .000100 [0.00254] |
| Strip of 10 | Black | 531230-2 | 531230-3 | 531230-1 |

¹In contact area

Material and Finish — Low Profile and 2mm Shunts

Housing — Glass-filled thermoplastic, black, UL 94V-0 rated

Contacts — Beryllium copper or phosphor bronze, plated .000050 [0.00127] nickel underplate with gold plate in contact area or tin overall

Material and Finish — Tandem Spring Shunts

Housing — Nylon, UL 94V-0 rated

Contacts — Phosphor Bronze

Finish — .000030 [0.00076] nickel underplate with gold inlay in the contact area or tin overall

Note: All part numbers are RoHS compliant.

Post Shunts (Continued)

2-Position, Low Profile Shunts (Novo)
(Continued)

Handle Shunt
.100 [2.54] Centerline

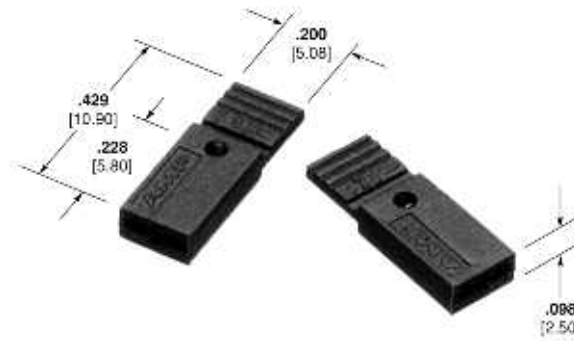

| Housing Color | Loose Piece Part Numbers | | | | Type |
|---------------|--------------------------------------|--------------------------------------|--------------------------------------|------------------------|------------|
| | Gold Plate ¹ [0.00038] | Gold Plate ¹ [0.00076] | Gold Plate ¹ [0.00127] | Tin Plate [0.00254] | |
| Black | 881545-1 | 881545-2 | 881545-3 | 4-881545-2 | Open Top |
| Black | 880584-1 | 880584-2 | 880584-3 | 880584-4 | Closed Top |

¹In contact area

2 mm Mini-Shunt
.079 [2.00] Centerline

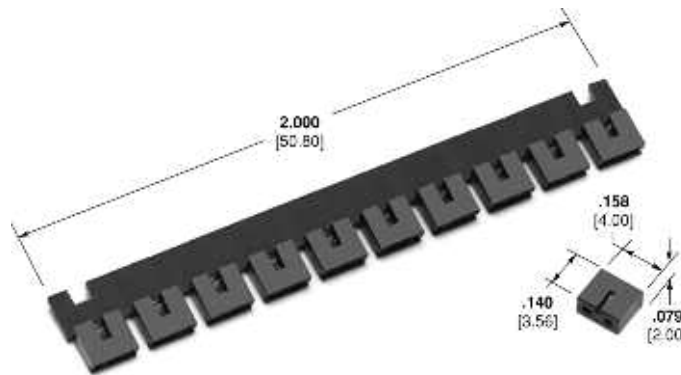

| Configuration | Housing Color | Part Numbers | |
|---------------|---------------|--------------------------------------|--------------------------------------|
| | | Gold Plate ¹ [0.00038] | Gold Plate ¹ [0.00076] |
| Strip of 10 | Black | 382575-2 | 382575-3 |

¹In contact area

Dual Beam Shunt

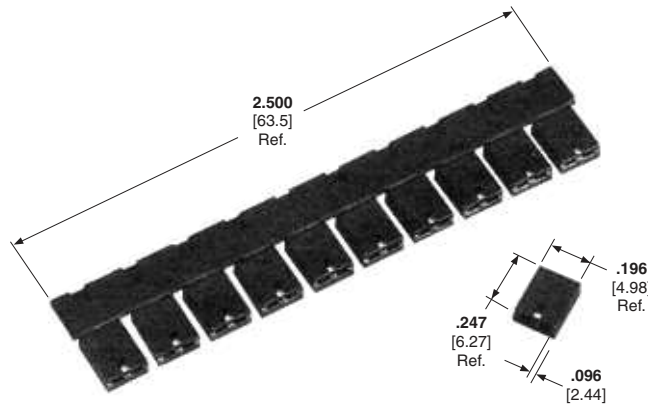

| Configuration | Housing Color | Part Numbers | | Type |
|---------------|---------------|--------------------------------------|--------------------------------------|----------|
| | | Gold Plate ¹ [0.00038] | Gold Plate ¹ [0.00076] | |
| Strip of 10 | Black | 390088-2 | 390088-1 | Open Top |
| Strip of 10 | Blue | 390088-4 | 390088-3 | Open Top |
| Strip of 10 | Yellow | — | 390088-5 | Open Top |

¹In contact area

Note: All part numbers are RoHS compliant.

Post Shunts (Continued)

Tandem Spring Shunt

.100 [2.54] Centerline

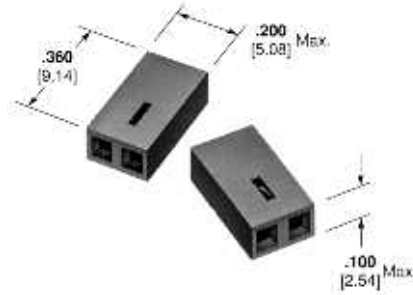

| Housing Color | Part Numbers | |
|---------------|-------------------------|----------------------|
| | Gold Inlay ¹ | TinPlate |
| | .000030 [0.00076] | .000100 [0.00254] |
| Black | 530153-2 | 4-530153-1 |

¹In contact area

Multiposition Shunts for .025 [0.64] Square Posts

.200 [5.08] Centerline



Housing — Glass-filled polyester
Contacts — Beryllium Copper
Finish — .000030 [0.00076] gold in contact area over .000050 [0.00127] nickel on entire contact
Current Rating — 2.5 amps

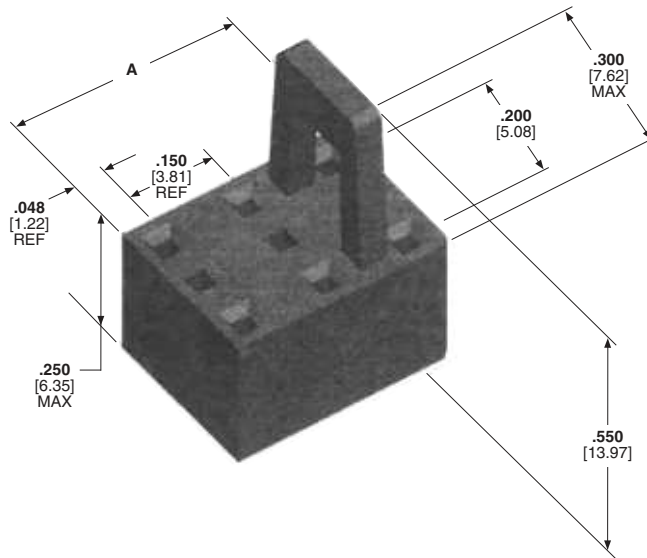

| Size | Dimension A | | Housing Color | Part Number |
|------|-------------|-------|---------------|-------------|
| | inch | mm | | |
| 2x2 | .246 | 6.25 | Black | 390102-1 |
| 2x2 | .246 | 6.25 | Red | 390102-3 |
| 2x3 | .396 | 10.01 | Black | 390102-2 |

Note: All part numbers are RoHS compliant.

Performance Specifications

Dual In-Line Package (DIP) Shunts — 7600 Series

Current Rating —

Standard pressure — 2 amperes for +20°C rise above ambient (one conductor per shunt)
 Machine insertable — 1 ampere for +20°C rise above ambient (one conductor per shunt)

Insulation Resistance — 1×10^{10} ohms min. at 100 VDC

Dielectric Withstanding Voltage — 500 VDC min.

Capacitance — 2 picofarads max. between adjacent straps

Temperature Rating — -55°C to +105°C

Terminal Strength (Bend Test) — Two 45° bend cycles per MIL-STD-202, Method 211, Condition B

Solder Bridging —

Cut straps can be reconnected by solder bridging. Solder bridging recommendations are:

- Use low temperature solder (60/40 tin/lead)
- Use solder tip approximately 1/32 [0.79] in diameter
- Do not let solder tip come in contact with plastic material

Post Shunts

Current Rating —

3 amperes max. unless otherwise noted

Temperature Rating — -65°C to +105°C (gold) -40°C to +85°C (tin)

Technical Documents

Various technical documents are available for your use:

Product Specifications describe technical performance characteristics and verification tests. They are intended for the Design, Component and Quality Engineer.

| | |
|-----------|------------------------------------|
| 108-7533 | Dual In-Line Package (DIP) Shunts |
| 108-1445 | 2mm Mini Shunt |
| 108-1476 | Economy Shunt, Multiposition Shunt |
| 108-1674 | Dual Beam Shunt |
| 108-9057 | Low Profile Shunt |
| 108-9062 | Tandem Spring Shunt |
| 108-37006 | Novo Shunt with Handle |

Application Specifications describe requirements for using the product in its intended application and/or crimping information. They are intended for the Packaging and Design Engineer and the Machine Setup Person.

| | |
|----------|--|
| 114-1045 | Tandem Spring Shunt |
| 114-1054 | Dual In-Line Package (DIP) Shunts |
| 114-1059 | Economy Shunt, Dual Beam Shunt, Low Profile Shunt, Multiposition Shunt |
| 114-1074 | 2mm Mini Shunt |

Instruction Sheets provide instructions for assembling or applying the product. They are intended for the Manufacturing Assembler or Operator.

| | |
|----------|---|
| 408-7768 | Dual In-Line Package (DIP) Shunts |
| 408-3208 | Tandem Spring Shunt |
| 408-3230 | Economy Shunt, Dual Beam Shunt, Low Profile Shunt |
| 408-3251 | Multiposition Shunt |
| 408-3276 | 2mm Mini Shunt |

Engineering Notes



8

Part Number Index

Note: This index lists all cataloged parts by base no. only. Complete part nos. (with prefixes and/or suffixes) are shown on the page(s) indicated.

| Part No. | Page | Part No. | Page | Part No. | Page |
|----------|--|----------|----------------------|----------|---------------|
| 19156 | 139, 140 | 87227 | 85, 96, 97 | 102104 | 290 |
| 57013 | 58 | 87230 | 85, 98, 99 | 102106 | 290 |
| 57038 | 58 | 87232 | 85, 94, 95, 210, 221 | 102107 | 211 |
| 57118 | 58 | 87233 | 94, 95 | 102114 | 203 |
| 57119 | 58 | 87247 | 295 | 102128 | 210, 213 |
| 57131 | 58, 59 | 87258 | 297 | 102185 | 255, 258, 259 |
| 57138 | 58 | 87262 | 295 | 102198 | 139, 140 |
| 57139 | 58 | 87269 | 298 | 102202 | 115, 210 |
| 57144 | 58 | 87270 | 299 | 102203 | 85, 116 |
| 57145 | 58 | 87278 | 298 | 102241 | 210, 215 |
| 57288 | 58 | 87283 | 296 | 102312 | 258, 259 |
| 57289 | 58 | 87309 | 213 | 102316 | 213 |
| 57290 | 58 | 87316 | 286 | 102338 | 203 |
| 85487 | 286 | 87456 | 210, 216 | 102348 | 211 |
| 85493 | 286 | 87474 | 129 | 102387 | 210, 220 |
| 85829 | 295 | 87483 | 210 | 102393 | 256 |
| 85839 | 296 | 87496 | 133 | 102394 | 256 |
| 85840 | 296 | 87499 | 210, 214 | 102395 | 265 |
| 85875 | 296 | 87523 | 213 | 102396 | 255, 259 |
| 85923 | 296 | 87568 | 127 | 102398 | 255, 256 |
| 85969 | 213 | 87572 | 126 | 102399 | 265 |
| 86016 | 213 | 87577 | 124, 125 | 102448 | 256 |
| 86147 | 294 | 87579 | 122, 123 | 102449 | 265 |
| 86177 | 216 | 87587 | 119, 120 | 102523 | 116 |
| 86181 | 285, 287, 288 | 87589 | 117, 118 | 102536 | 255, 259 |
| 86182 | 294 | 87605 | 85, 131 | 102537 | 255, 259 |
| 86207 | 296 | 87608 | 130 | 102540 | 255, 259 |
| 86286 | 169, 172, 175-177, 180, 182, 189, 191, 195-197, 214-218, 220, 256, 257 | 87623 | 163 | 102541 | 255, 259 |
| 86432 | 286 | 87631 | 210, 218, 219 | 102548 | 213 |
| 86434 | 286 | 87654 | 297 | 102557 | 149 |
| 86477 | 286 | 87655 | 297 | 102567 | 198 |
| 86479 | 98, 99 | 87666 | 213 | 102570 | 124, 125 |
| 86480 | 286 | 87667 | 213 | 102589 | 193, 200 |
| 86492 | 213 | 87710 | 218 | 102617 | 122, 123 |
| 87003 | 286 | 87733 | 219 | 102618 | 117, 118 |
| 87022 | 163 | 87743 | 204 | 102619 | 119, 120 |
| 87025 | 291 | 87756 | 210, 213 | 102620 | 127 |
| 87046 | 213 | 87772 | 286 | 102641 | 265 |
| 87077 | 214-218, 220, 256, 257 | 87774 | 286 | 102642 | 265 |
| 87105 | 286 | 87809 | 213 | 102666 | 199 |
| 87107 | 211 | 87878 | 163 | 102681 | 255, 259 |
| 87116 | 293 | 87879 | 85, 177 | 102690 | 193, 199 |
| 87124 | 207 | 87921 | 218 | 102691 | 199 |
| 87131 | 209 | 87922 | 218, 219 | 102692 | 198 |
| 87132 | 209 | 87977 | 210, 217 | 102693 | 257 |
| 87133 | 209 | 87983 | 287 | 102694 | 257 |
| 87159 | 293 | 87984 | 287 | 102695 | 257 |
| 87160 | 295 | 87985 | 287 | 102699 | 85, 148 |
| 87165 | 207 | 87986 | 287 | 102742 | 177 |
| 87175 | 208 | 87987 | 289 | 102766 | 142 |
| 87176 | 209 | 87988 | 289 | 102777 | 199 |
| 87179 | 208, 209 | 87989 | 287 | 102783 | 262, 263 |
| 87190 | 207 | 87990 | 287 | 102784 | 262, 263 |
| 87191 | 207 | 87993 | 287 | 102785 | 262, 263 |
| 87194 | 297 | 87995 | 289 | 102786 | 262, 263 |
| 87195 | 213 | 102055 | 126 | 102787 | 262, 263 |
| 87215 | 96, 97 | 102090 | 292 | 102788 | 262, 263 |
| 87220 | 85, 93 | 102095 | 211 | 102789 | 263 |
| 87224 | 93 | 102099 | 290 | 102791 | 264 |
| | | 102100 | 290 | 102792 | 264 |
| | | 102102 | 290 | 102802 | 200 |
| | | 102103 | 290 | 102823 | 259 |

Part Number Index (Continued)

| Part No. | Page | Part No. | Page | Part No. | Page | Part No. | Page |
|----------|------------------------|----------|----------|----------|---------------|----------|--------------|
| 102826 | 144 | 103639 | 245 | 103960 | 231 | 104895 | 19 |
| 102871 | 143 | 103640 | 231 | 103961 | 231 | 104905 | 208 |
| 102898 | 146 | 103641 | 231 | 103968 | 233 | 104909 | 245 |
| 102903 | 263 | 103644 | 231 | 103969 | 233 | 104910 | 245 |
| 102917 | 213 | 103645 | 231 | 103970 | 233 | 104935 | 247 |
| 102918 | 213 | 103648 | 233 | 103971 | 233 | 111196 | 56 |
| 102920 | 213 | 103649 | 233 | 103972 | 233 | 146079 | 163 |
| 102935 | 280 | 103650 | 233 | 103973 | 233 | 146128 | 109 |
| 102972 | 107 | 103651 | 233 | 103974 | 229 | 146129 | 109 |
| 102973 | 107 | 103652 | 233 | 103975 | 229 | 146130 | 110 |
| 102976 | 107 | 103653 | 237 | 103976 | 229 | 146131 | 110 |
| 102977 | 107 | 103654 | 239 | 103977 | 229 | 146132 | 86, 109 |
| 102985 | 263 | 103655 | 239 | 103978 | 229 | 146133 | 109 |
| 102987 | 261, 263 | 103656 | 239 | 103979 | 229 | 146134 | 86, 110 |
| 102988 | 261, 263 | 103657 | 239 | 104068 | 30 | 146135 | 110 |
| 102991 | 264 | 103658 | 237 | 104069 | 29 | 146138 | 178 |
| 103056 | 281 | 103659 | 237 | 104071 | 28 | 146205 | 202 |
| 103058 | 281 | 103660 | 237 | 104074 | 27 | 146250 | 104, 107 |
| 103080 | 115 | 103661 | 237 | 104076 | 31 | 146252 | 104, 107 |
| 103136 | 261, 263 | 103669 | 245 | 104078 | 40 | 146253 | 104, 107 |
| 103137 | 261, 263 | 103672 | 247 | 104118 | 34 | 146254 | 104, 107 |
| 103138 | 262, 263 | 103673 | 247 | 104178 | 33 | 146256 | 104, 107 |
| 103139 | 262, 263 | 103680 | 240 | 104186 | 32 | 146257 | 85, 104, 107 |
| 103140 | 262, 263 | 103681 | 241 | 104192 | 38 | 146258 | 104 |
| 103141 | 262, 263 | 103682 | 242 | 104196 | 37 | 146260 | 104 |
| 103152 | 261, 263 | 103684 | 229 | 104257 | 221, 231 | 146261 | 104 |
| 103153 | 261, 263 | 103685 | 229 | 104271 | 261, 263 | 146262 | 104 |
| 103157 | 261, 263 | 103686 | 229 | 104272 | 261, 263 | 146264 | 104 |
| 103158 | 261, 263 | 103687 | 229 | 104317 | 121 | 146265 | 104 |
| 103164 | 85, 126 | 103688 | 221, 229 | 104319 | 128 | 146266 | 104 |
| 103165 | 127 | 103734 | 231 | 104361 | 250 | 146268 | 85, 104 |
| 103166 | 85, 122, 123, 210, 255 | 103735 | 245 | 104362 | 245 | 146269 | 104 |
| 103167 | 124, 125 | 103817 | 86, 100 | 104363 | 245 | 146270 | 104 |
| 103168 | 85, 117, 118, 210, 255 | 103893 | 237 | 104438 | 234 | 146272 | 104 |
| 103169 | 119, 120 | 103894 | 237 | 104439 | 234 | 146273 | 104 |
| 103171 | 213 | 103895 | 239 | 104450 | 221, 248 | 146274 | 102, 107 |
| 103185 | 107 | 103896 | 239 | 104477 | 29 | 146276 | 102, 107 |
| 103186 | 107 | 103897 | 231 | 104479 | 221, 222, 253 | 146277 | 102, 107 |
| 103233 | 147 | 103900 | 233 | 104480 | 221, 222, 253 | 146278 | 102, 107 |
| 103239 | 107 | 103901 | 233 | 104481 | 221, 222, 253 | 146280 | 102, 107 |
| 103240 | 107 | 103902 | 229 | 104482 | 221, 223 | 146281 | 85, 102, 107 |
| 103264 | 193, 201 | 103903 | 229 | 104483 | 224 | 146282 | 102 |
| 103268 | 259 | 103904 | 247 | 104500 | 241 | 146284 | 102 |
| 103291 | 199 | 103908 | 245 | 104503 | 239 | 146285 | 102 |
| 103321 | 107 | 103911 | 39 | 104505 | 254 | 146286 | 102 |
| 103322 | 107 | 103916 | 35 | 104506 | 254 | 146288 | 102 |
| 103327 | 107 | 103944 | 237 | 104549 | 44 | 146289 | 102 |
| 103328 | 107 | 103945 | 237 | 104550 | 45 | 146290 | 102 |
| 103336 | 85, 146 | 103946 | 237 | 104583 | 282 | 146292 | 102 |
| 103340 | 261, 263 | 103947 | 237 | 104584 | 282 | 146293 | 85, 102 |
| 103341 | 261, 263 | 103948 | 237 | 104652 | 15 | 146294 | 102 |
| 103349 | 281 | 103949 | 237 | 104655 | 16 | 146296 | 102 |
| 103350 | 281 | 103950 | 239 | 104656 | 16 | 146297 | 102 |
| 103361 | 116 | 103951 | 239 | 104666 | 30 | 146304 | 85, 103 |
| 103414 | 85, 115 | 103952 | 239 | 104693 | 16 | 146305 | 103 |
| 103455 | 213 | 103953 | 239 | 104744 | 40 | 146306 | 85, 103 |
| 103542 | 85, 147 | 103954 | 239 | 104804 | 28 | 146307 | 103 |
| 103577 | 85, 163 | 103955 | 239 | 104809 | 249 | 146308 | 85, 105 |
| 103634 | 247 | 103956 | 231 | 104891 | 22 | 146309 | 105 |
| 103635 | 247 | 103957 | 231 | 104892 | 21 | 146310 | 105 |
| | | 103958 | 231 | 104893 | 21 | 146311 | 105 |
| | | 103959 | 231 | 104894 | 19 | 146315 | 202 |

Part Number Index (Continued)

| Part No. | Page | Part No. | Page | Part No. | Page | Part No. | Page |
|----------|---------|----------|----------|----------|--------------------|----------|---------------|
| 146386 | 175 | 146852 | 107 | 147740 | 192 | 1375582 | 252 |
| 146427 | 85 | 146853 | 107 | 147741 | 192 | 1375583 | 252 |
| 146455 | 112 | 146858 | 107 | 147742 | 187 | 1375791 | 7, 12 |
| 146456 | 112 | 146859 | 107 | 147743 | 187 | 1375792 | 7 |
| 146457 | 112 | 146860 | 107 | 147744 | 187 | 1375793 | 7, 12 |
| 146458 | 112 | 146861 | 107 | 147745 | 190 | 1375794 | 7 |
| 146459 | 112 | 146868 | 107 | 147746 | 190 | 1375795 | 6, 12 |
| 146460 | 112 | 146869 | 107 | 147747 | 190 | 1375796 | 6 |
| 146461 | 112 | 146870 | 107 | 173144 | 155, 156 | 1375797 | 9 |
| 146462 | 112 | 146871 | 107 | 173145 | 155, 157, 158, 159 | 1375798 | 9 |
| 146463 | 112 | 147030 | 235 | 173146 | 155, 160, 161 | 1375799 | 8 |
| 146464 | 112 | 147070 | 86, 167 | 219054 | 58 | 1375800 | 8 |
| 146465 | 112 | 147071 | 167 | 219055 | 58 | 1375801 | 12 |
| 146466 | 112 | 147072 | 167 | 219137 | 58 | 1375959 | 10 |
| 146467 | 112 | 147095 | 183, 184 | 219138 | 58 | 1375961 | 10 |
| 146468 | 112 | 147096 | 183, 184 | 219253 | 58 | 1375963 | 10 |
| 146469 | 112 | 147099 | 182 | 382575 | 309 | 1375965 | 11 |
| 146470 | 112 | 147100 | 182 | 382811 | 308 | 1375967 | 11 |
| 146471 | 112 | 147101 | 190 | 390088 | 309 | 1445251 | 12 |
| 146472 | 112 | 147102 | 190 | 390102 | 310 | 1445439 | 12 |
| 146473 | 112 | 147103 | 190 | 487544 | 50 | 1445440 | 12 |
| 146474 | 86, 112 | 147104 | 192 | 487545 | 50 | 1445441 | 12 |
| 146475 | 112 | 147105 | 86, 192 | 487547 | 48 | 1470108 | 79 |
| 146476 | 112 | 147106 | 192 | 487576 | 54 | 1470109 | 78 |
| 146477 | 112 | 147121 | 16 | 487923 | 48 | 1470209 | 80 |
| 146478 | 112 | 147254 | 202 | 487937 | 52 | 1470213 | 66 |
| 146479 | 112 | 147278 | 251 | 487938 | 52 | 1734493 | 75 |
| 146480 | 112 | 147323 | 251 | 487940 | 48 | 1734506 | 81 |
| 146481 | 112 | 147324 | 251 | 487941 | 48 | 1734507 | 67 |
| 146482 | 112 | 147326 | 177 | 499991 | 205 | 1734508 | 66 |
| 146483 | 113 | 147333 | 86, 165 | 530153 | 310 | 1734516 | 84 |
| 146484 | 113 | 147334 | 165 | 530554 | 267 | 1734531 | 83 |
| 146485 | 113 | 147335 | 165 | 530901 | 269 | 1734569 | 77 |
| 146486 | 113 | 147377 | 44 | 530902 | 268 | 1734606 | 82 |
| 146487 | 113 | 147378 | 45 | 531226 | 267, 268 | 1734770 | 73 |
| 146488 | 113 | 147381 | 16 | 531230 | 308 | 1825190 | 307 |
| 146489 | 113 | 147382 | 16 | 532955 | 195 | 1825851 | 139, 140, 210 |
| 146490 | 85, 113 | 147383 | 16 | 532956 | 193, 195 | 2041068 | 76 |
| 146491 | 113 | 147384 | 15 | 533009 | 195 | 2041069 | 84 |
| 146492 | 113 | 147396 | 235 | 534204 | 195 | 5084476 | 71 |
| 146493 | 113 | 147413 | 15 | 534206 | 85, 176 | 5084780 | 74 |
| 146494 | 113 | 147424 | 176 | 534237 | 85, 175 | 5086147 | 294 |
| 146495 | 113 | 147433 | 165 | 534245 | 200 | 5086182 | 294 |
| 146496 | 113 | 147434 | 165 | 534257 | 198 | 5102084 | 170 |
| 146497 | 113 | 147435 | 165 | 534258 | 201 | 5102154 | 139, 210, 255 |
| 146498 | 113 | 147436 | 167 | 534267 | 85, 182 | 5102156 | 139 |
| 146499 | 113 | 147437 | 167 | 534972 | 193, 196 | 5102160 | 140 |
| 146500 | 113 | 147438 | 167 | 534974 | 193, 197 | 5102162 | 140 |
| 146501 | 113 | 147503 | 16 | 534975 | 195 | 5103308 | 135 |
| 146502 | 113 | 147720 | 86, 181 | 534978 | 198 | 5103309 | 135 |
| 146503 | 113 | 147723 | 188 | 534998 | 85, 179, 180 | 5103310 | 136 |
| 146504 | 113 | 147724 | 187 | 535541 | 85, 178 | 5103311 | 136 |
| 146505 | 113 | 147726 | 181 | 535542 | 86, 183, 184 | 5104338 | 137 |
| 146506 | 113 | 147727 | 181 | 535584 | 178 | 5104340 | 138 |
| 146507 | 113 | 147728 | 188 | 535585 | 179, 180 | 5111595 | 57 |
| 146508 | 113 | 147729 | 188 | 535598 | 179, 180 | 5146139 | 169 |
| 146509 | 113 | 147730 | 187 | 746383 | 139, 140 | 5146140 | 170 |
| 146510 | 113 | 147731 | 187 | 867052 | 207 | 5147721 | 86, 172 |
| 146762 | 176 | 147736 | 188 | 880584 | 309 | 5147722 | 86, 173 |
| 146763 | 175 | 147737 | 188 | 881545 | 309 | 5147732 | 172 |
| 146850 | 107 | 147738 | 86, 188 | 966926 | 72 | 5147733 | 172 |
| 146851 | 107 | 147739 | 192 | 1375549 | 252 | 5147734 | 173 |

Part Number Index (Continued)

| Part No. | Page | Part No. | Page | Part No. | Page | Part No. | Page |
|----------|------|----------|------|----------|------|----------|---------|
| 5147735 | 173 | 5178751 | 70 | 5531216 | 269 | 5535512 | 85, 170 |
| 5176264 | 70 | 5530553 | 269 | 5531224 | 269 | 5535676 | 85, 169 |
| 5176837 | 68 | 5530901 | 269 | 5531225 | 269 | 5535677 | 169 |

Tooling Part Number Index

Note: This index lists all cataloged parts by base no. only. Complete part nos. (with prefixes and/or suffixes) are shown on the page(s) indicated.

| Part No. | Page | Part No. | Page | Part No. | Page |
|----------|----------|----------|--------------------|----------|-----------------------------------|
| 58062 | 273 | 104072 | 253 | 527116 | 263 |
| 58074 | 273 | 217600 | 153, 164, 166, 303 | 543518 | 23 |
| 58075 | 273 | 224910 | 48, 60 | 547178 | 301 |
| 58336 | 273 | 265871 | 152 | 565967 | 286 |
| 58338 | 273 | 265964 | 152 | 567239 | 254 |
| 58342 | 254 | 308554 | 152 | 567296 | 222, 253 |
| 58395 | 273 | 312522 | 274 | 567297 | 222, 253 |
| 58540 | 273 | 318619 | 48, 60 | 567298 | 222, 253 |
| 58641 | 211, 213 | 354500 | 300 | 567307 | 211 |
| 90273 | 60 | 354786 | 275 | 567310 | 207 |
| 90274 | 290 | 356484 | 60 | 662820 | 303 |
| 90295 | 207 | 356500 | 300 | 679167 | 62 |
| 90308 | 298 | 380392 | 152 | 679996 | 207 |
| 90328 | 290 | 466007 | 298 | 758030 | 162 |
| 90381 | 211 | 466376 | 286 | 761420 | 275 |
| 90431 | 207 | 466562 | 213 | 768338 | 62 |
| 91047 | 60 | 466571 | 213 | 812665 | 263 |
| 91084 | 207 | 466655 | 213 | 843473 | 290 |
| 91085 | 62 | 466721 | 207 | 843477 | 253, 254, 265 |
| 91104 | 298 | 466723 | 269 | 843996 | 214, 215, 216, 217, 218, 219, 220 |
| 91112 | 62 | 466763 | 290 | 854040 | 301 |
| 91169 | 152 | 466764 | 290 | 854449 | 274 |
| 91170 | 152 | 466812 | 211 | 856002 | 274 |
| 91171 | 152 | 466819 | 269 | 856675 | 273 |
| 91200 | 60 | 466905 | 213 | 904507 | 163 |
| 91295 | 23 | 466918 | 213 | 904590 | 163 |
| 91410 | 263 | 466921 | 213 | 904591 | 163 |
| 91419 | 163 | 466937 | 290 | 904592 | 163 |
| 91516 | 213 | 466943 | 269 | 904640 | 166 |
| 91517 | 211, 213 | 466950 | 298 | 904641 | 164 |
| 91518 | 222, 253 | 466952 | 269 | 907459 | 162 |
| 91531 | 254 | 466980 | 222, 253 | 931800 | 273 |
| 91533 | 207 | 466981 | 222, 253 | 1213400 | 300 |
| 91541 | 213 | 466982 | 222, 253 | | |
| 91551 | 222, 253 | 466983 | 254 | | |

Engineering Notes

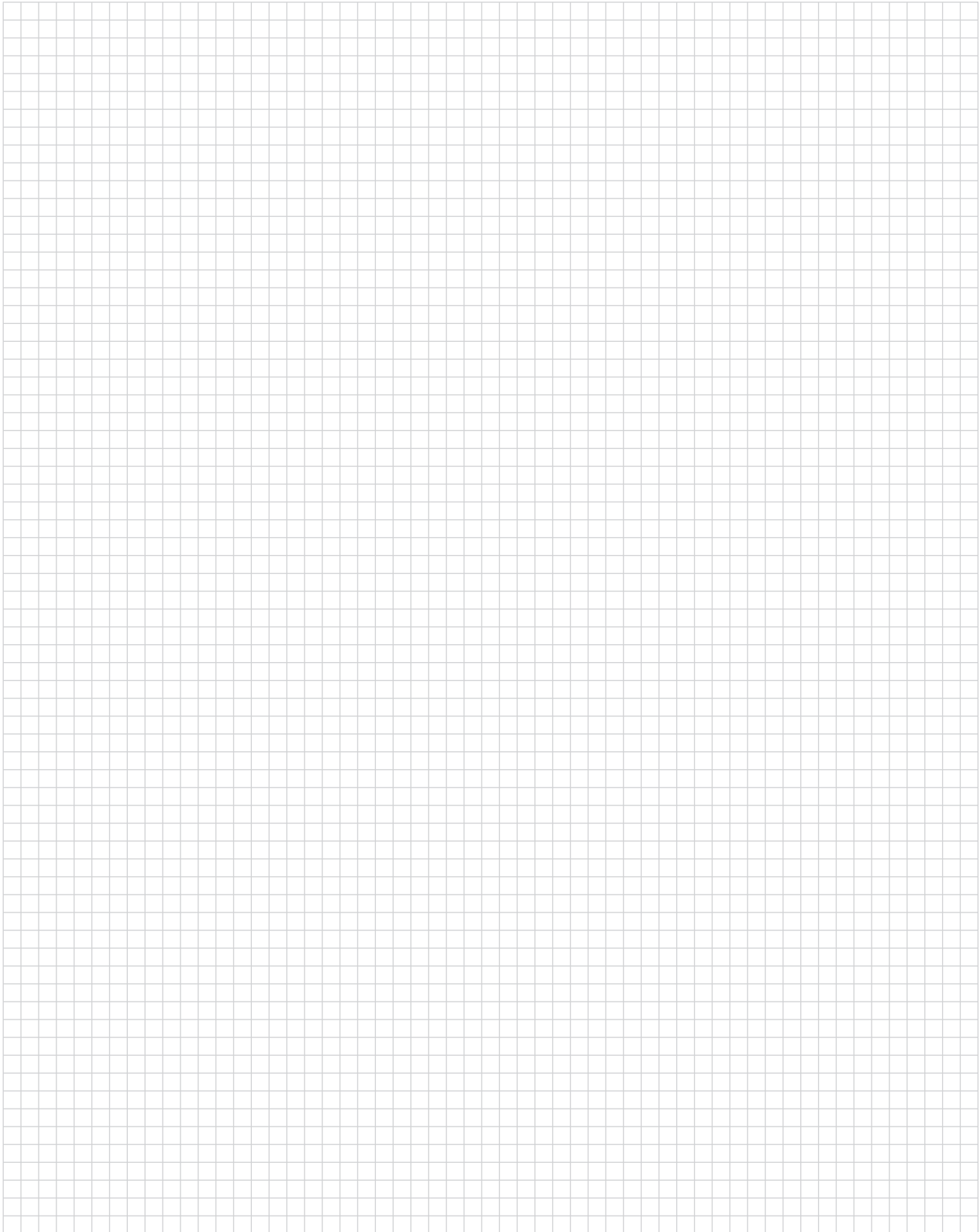

Engineering Notes



Engineering Notes

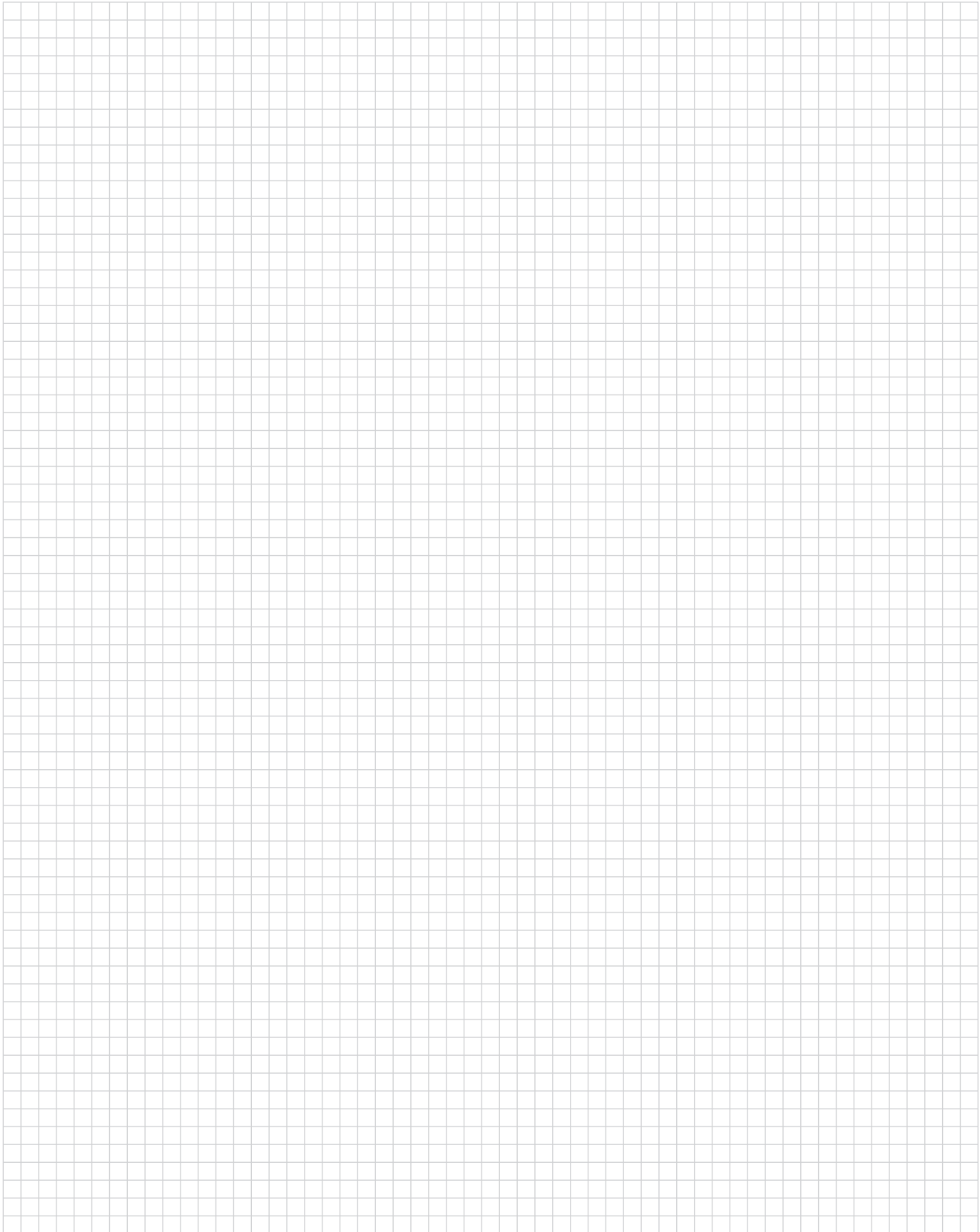

Engineering Notes



FOR MORE INFORMATION

te.com/products/AMPMODUSystem50

te.com/products/AMPMODUMTE

TE Technical Support Center

| | |
|-------------------|--|
| Internet: | te.com/help |
| USA: | +1 (800) 522-6752 |
| Canada: | +1 (905) 475-6222 |
| Mexico: | +52 (0) 55-1106-0800 |
| Latin/S. America: | +54 (0) 11-4733-2200 |
| Germany: | +49 (0) 6251-133-1999 |
| UK: | +44 (0) 800-267666 |
| France: | +33 (0) 1-3420-8686 |
| Netherlands: | +31 (0) 73-6246-999 |
| China: | +86 (0) 400-820-6015 |

Part numbers in this brochure are RoHS Compliant*, unless marked otherwise.

*as defined www.te.com/leadfree

te.com

© 2011 Tyco Electronics Corporation, a TE Connectivity Ltd. Company. All Rights Reserved.

1307819 CIS WR 08/2011

AMP, ACTION PIN, AMP-LATCH, AMP-O-ELECTRIC, AMP-O-MATIC, AMPLIMITE, AMPMODU, AMPOMATOR, CERTI-CRIMP, CHAMPOMATOR, PRO-CRIMPER, R-CAM, TE Connectivity and the TE connectivity (logo) are trademarks.

Other logos, product and Company names mentioned herein may be trademarks of their respective owners.

While TE has made every reasonable effort to ensure the accuracy of the information in this catalog, TE does not guarantee that it is error-free, nor does TE make any other representation, warranty or guarantee that the information is accurate, correct, reliable or current. TE reserves the right to make any adjustments to the information contained herein at any time without notice. TE expressly disclaims all implied warranties regarding the information contained herein, including, but not limited to, any implied warranties of merchantability or fitness for a particular purpose. The dimensions in this catalog are for reference purposes only and are subject to change without notice. Specifications are subject to change without notice. Consult TE for the latest dimensions and design specifications.

