

ON Semiconductor

Is Now

onsemi™

To learn more about onsemi™, please visit our website at
www.onsemi.com

onsemi and **onsemi** and other names, marks, and brands are registered and/or common law trademarks of Semiconductor Components Industries, LLC dba "**onsemi**" or its affiliates and/or subsidiaries in the United States and/or other countries. **onsemi** owns the rights to a number of patents, trademarks, copyrights, trade secrets, and other intellectual property. A listing of **onsemi** product/patent coverage may be accessed at www.onsemi.com/site/pdf/Patent-Marking.pdf. **onsemi** reserves the right to make changes at any time to any products or information herein, without notice. The information herein is provided "as-is" and **onsemi** makes no warranty, representation or guarantee regarding the accuracy of the information, product features, availability, functionality, or suitability of its products for any particular purpose, nor does **onsemi** assume any liability arising out of the application or use of any product or circuit, and specifically disclaims any and all liability, including without limitation special, consequential or incidental damages. Buyer is responsible for its products and applications using **onsemi** products, including compliance with all laws, regulations and safety requirements or standards, regardless of any support or applications information provided by **onsemi**. "Typical" parameters which may be provided in **onsemi** data sheets and/or specifications can and do vary in different applications and actual performance may vary over time. All operating parameters, including "Typicals" must be validated for each customer application by customer's technical experts. **onsemi** does not convey any license under any of its intellectual property rights nor the rights of others. **onsemi** products are not designed, intended, or authorized for use as a critical component in life support systems or any FDA Class 3 medical devices or medical devices with a same or similar classification in a foreign jurisdiction or any devices intended for implantation in the human body. Should Buyer purchase or use **onsemi** products for any such unintended or unauthorized application, Buyer shall indemnify and hold **onsemi** and its officers, employees, subsidiaries, affiliates, and distributors harmless against all claims, costs, damages, and expenses, and reasonable attorney fees arising out of, directly or indirectly, any claim of personal injury or death associated with such unintended or unauthorized use, even if such claim alleges that **onsemi** was negligent regarding the design or manufacture of the part. **onsemi** is an Equal Opportunity/Affirmative Action Employer. This literature is subject to all applicable copyright laws and is not for resale in any manner. Other names and brands may be claimed as the property of others.



ON Semiconductor®

User Guide 3.0
Hello Strata Power
LV DC-DC Ecosystem



Hello Strata Power. LV DC-DC Ecosystem. User Guide

Table of Contents

1.	INTRODUCTION.....	3
2.	DESIGN OVERVIEW	4
3.	BLOCK DIAGRAM	5
4.	SCOPE AND PURPOSE	5
5.	PREREQUISITES.....	5
6.	USER GUIDE	6
7.	USER INTERFACE.....	8
8.	SCHEMATIC MODULE EVALUATION BOARD	12

1. Introduction

The Strata low voltage DC-DC evaluation boards series is an evaluation environment for low voltage DC-DC conversion controllers, converters and regulators. The platforms are compatible with the Strata Developer Studio™, providing a Graphical User Interface for a hassle-free and fast device evaluation out of the box. Essential system variables values, such as input and output voltages, currents, power dissipation, temperatures and efficiencies are displayed and plotted on dynamic charts in real time, and can be exported as well. Load transients can be simulated with a signal generator. These Strata platforms can be used for Automotive and Industrial developments.

Features

- **Monitoring and setting of system variables via Strata GUI:**
 - Input and output voltages
 - Input and output currents
 - Power dissipation
 - Switching frequency
 - PWM adjustment
- **Load transient** generation from GUI
- **Fast evaluation with Strata Developer Studio**
- **Hardware**
 - Spacious layout with multiple test points for measurement
 - Operating temperature -40°C or +125°C

Applications

- Audio
- Infotainment
- Vision System
- Instrumentation
- Automotive low voltage DC-DC converters
- ADAS, Infotainment power management.
- Industrial imaging power management
- Industrial low voltage DC-DC conversion

Benefits

- Out of the box and fast evaluation and characterization of DC-DC ICs
- Speeds up development cycles and reduces time-to-market.
- All related collateral available at Strata Developer Studio™
- AEC-Q qualified parts

Hello Strata Power. LV DC-DC Ecosystem. User Guide

2. Design Overview

2D View

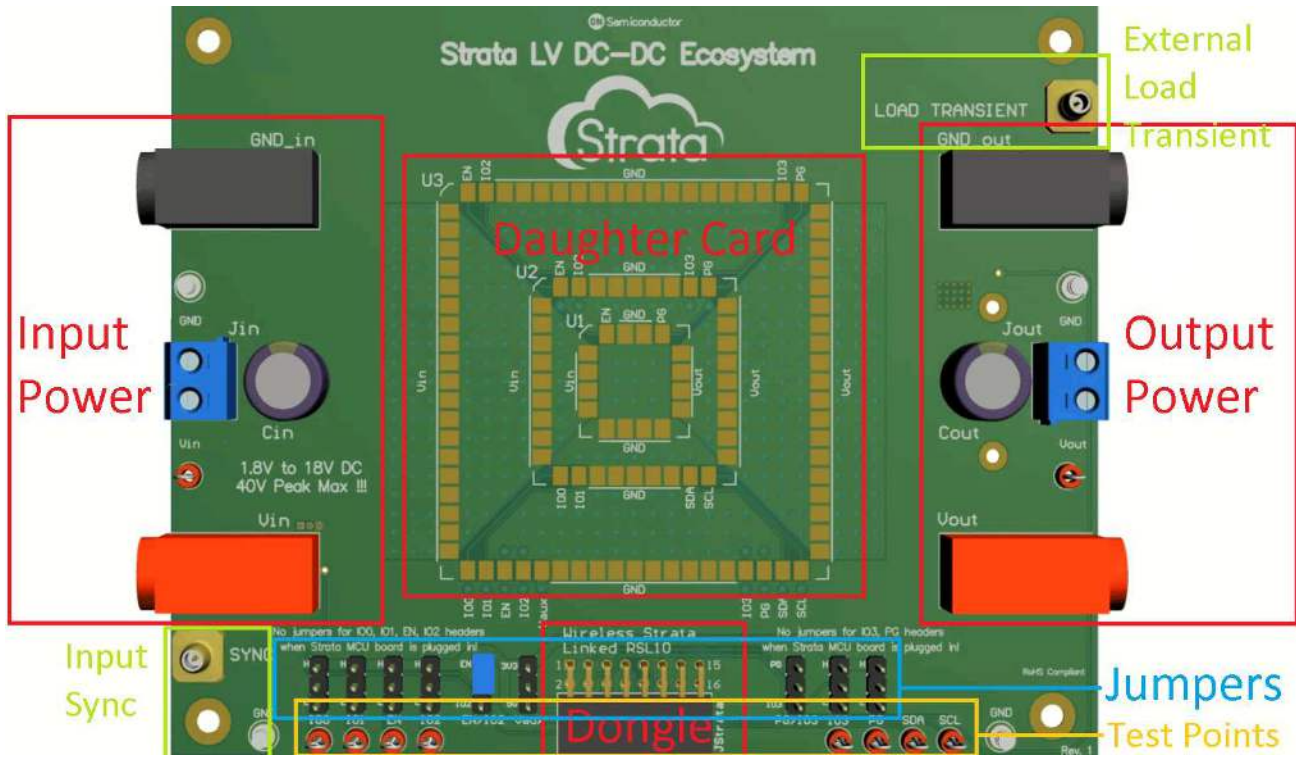

3D View

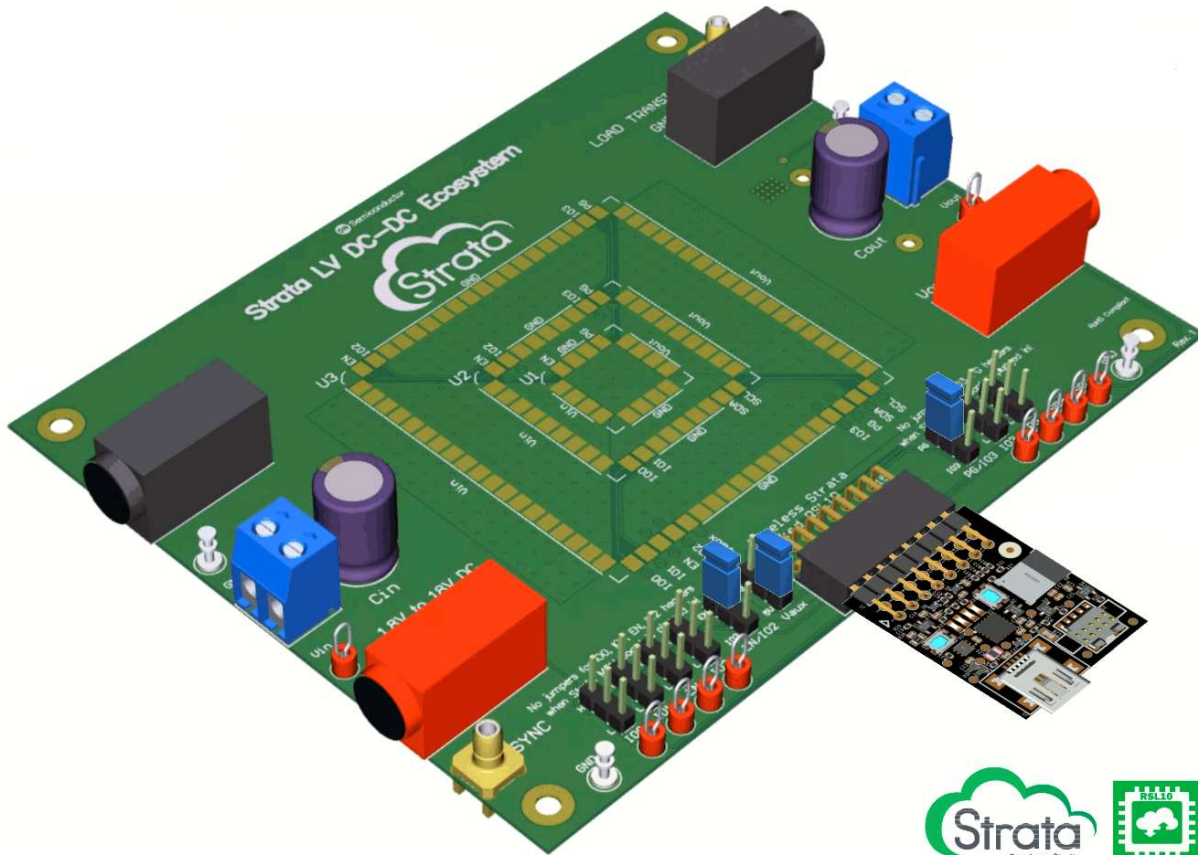

3. Block Diagram

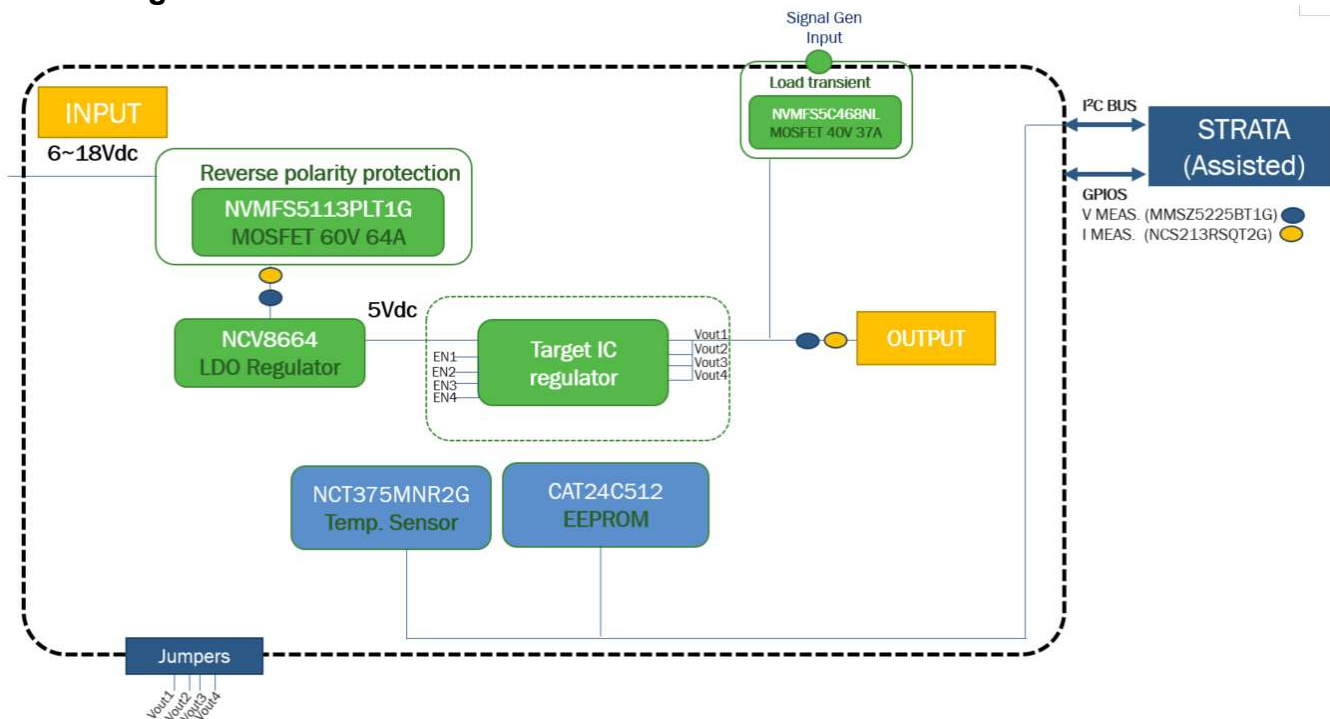

4. Scope and Purpose

This user guide provides practical guidelines for using the Strata Low Voltage Ecosystem evaluation boards series. The design was tested as described in this document but not qualified regarding safety requirements or manufacturing and operation over the whole operating temperature range or lifetime. The development board has been layout in a spacious manner so that it facilitates measurements and probing for the evaluation of the system and its components. The hardware is intended for functional testing under laboratory conditions and by trained specialists only.

5. Prerequisites

Hardware

- Strata Low Voltage Ecosystem evaluation boards series – (Strata Low Voltage Ecosystem evaluation kit consists of mother board + daughter card)
- Strata RSL10 Assisted Dongle
- External DC power supply

Software

[Strara Developer Studio™](http://onsemi.com)

6. User Guide

This section will explain how to use in a step by step manner the platform, and will cover both the hardware required as well as how to use the User Interface in Strata.

Hardware Setup

The hardware required for using the platform are a computer (with Windows) and a power supply. Follow the steps below.

1. Download and install the newest Strata Developer Studio:

[Strata Developer Studio™](#)

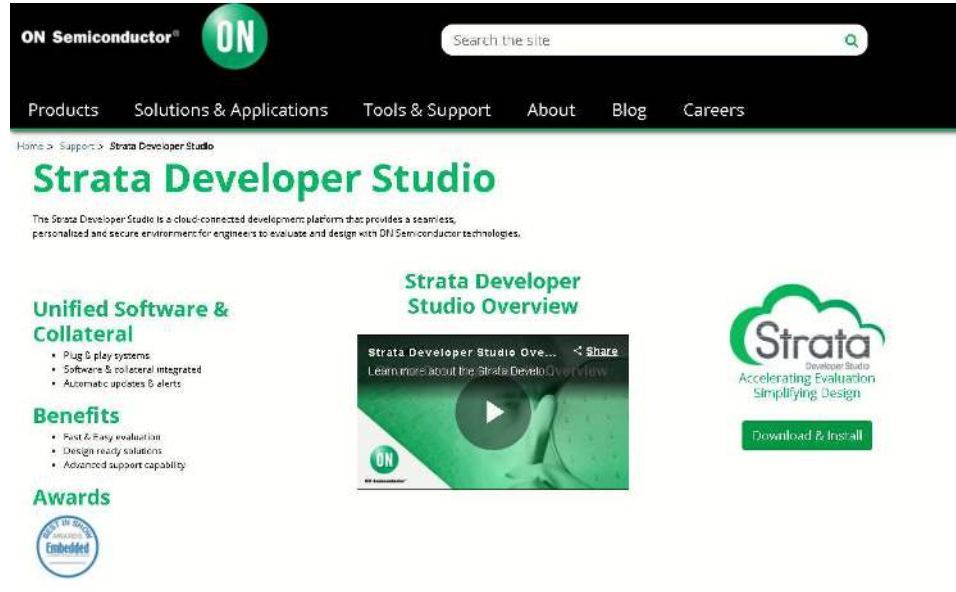

2. Plug the power supply into the input of the board using the banana plugs **V_{in}** and **GND_{in}**. Do not apply over 5V to the input and limit the output current to 1 Amps.

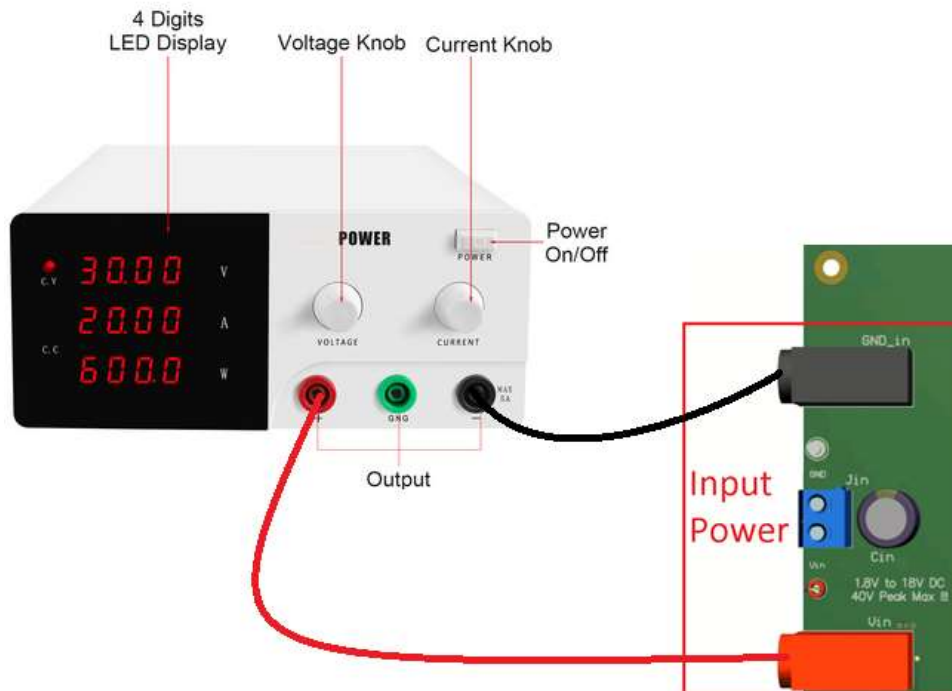

Hello Strata Power. LV DC-DC Ecosystem. User Guide

3. Connect the computer to the **RSL10 Assisted Dongle** using the **mini USB** connector and the **RSL10 Assisted Dongle** to the **Hello Strata LV DC-DC Ecosystem**.



4. Make sure that ALL jumpers are present.

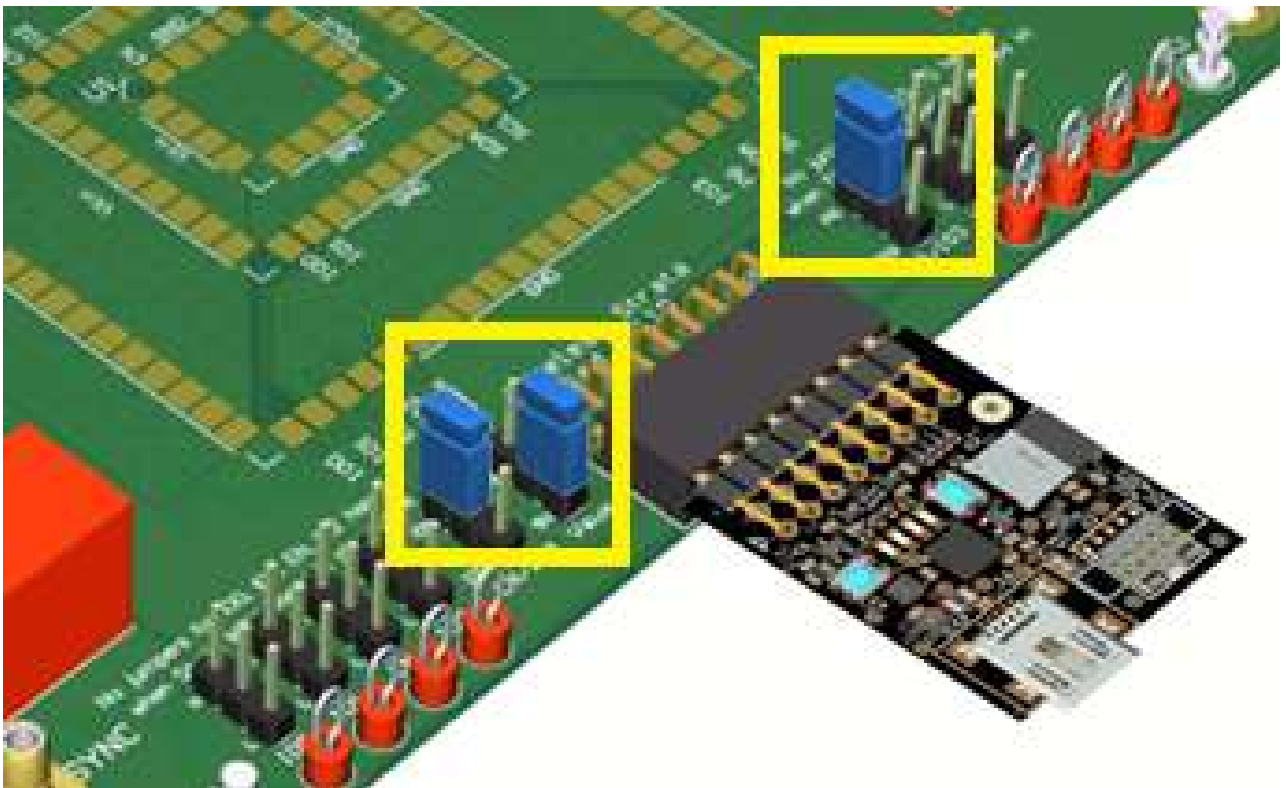

7. User Interface

The UI within the Strata app will allow the user to control the Hello Strata LV DC-DC Ecosystem platform and monitor its telemetry without needing other lab equipment or training to do so. The steps below cover what is in the UI.

1. Open Strata and Login, if necessary Register with your email and Password and Login



2. The view that comes up automatically when you plug in the mini USB is the basic view, which offers basic telemetry, an enable switch for enabling /disabling the switcher.



Hello Strata Power. LV DC-DC Ecosystem. User Guide

3. In the top right hand corner the user can switch to the Advanced view. The Advanced view offers more telemetry for the user to monitor, along with many more controls.



4. Real-Time Trend Analysis: The graph is displayed in below when tab menu is selected. The graph is hidden when tab menu is deselected.

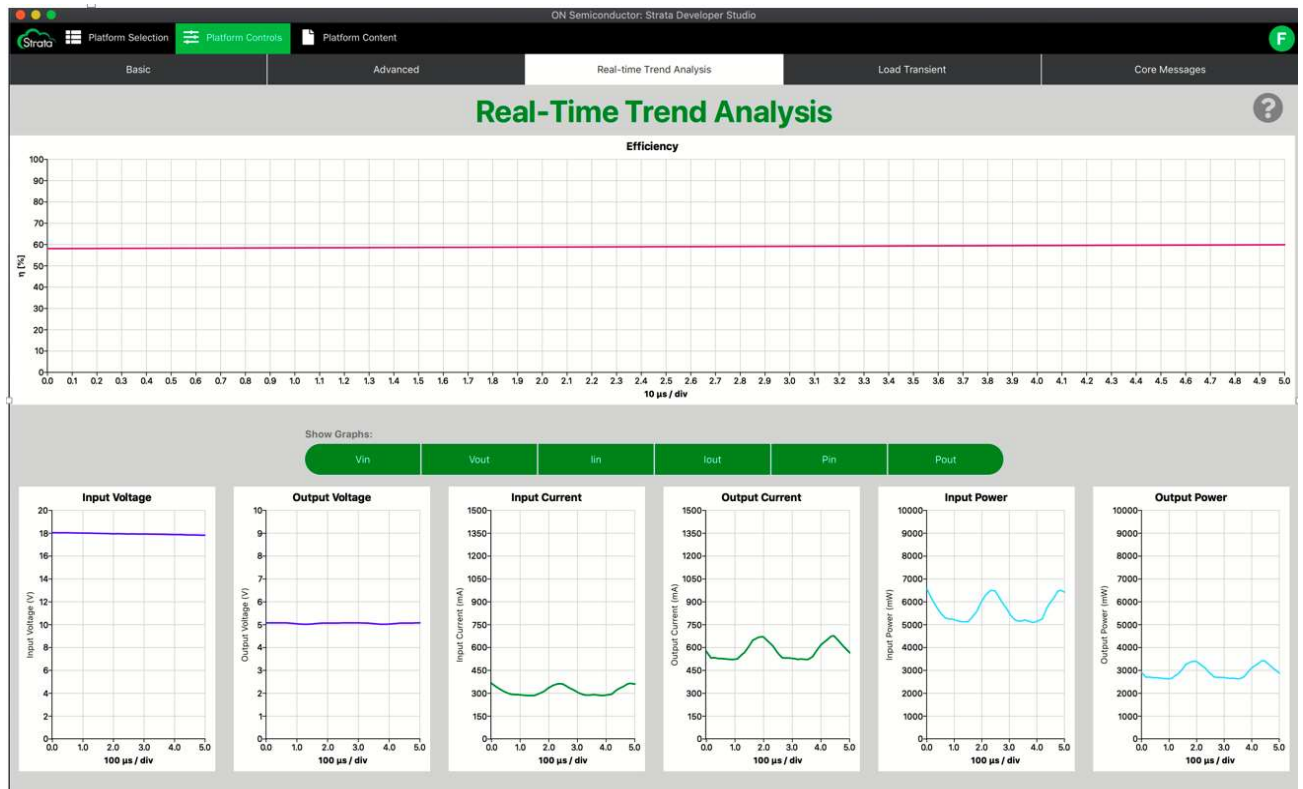

Hello Strata Power. LV DC-DC Ecosystem. User Guide

- The load is controlled from the GUI: We don't need an external electronic load. Please note, only power supply is required.

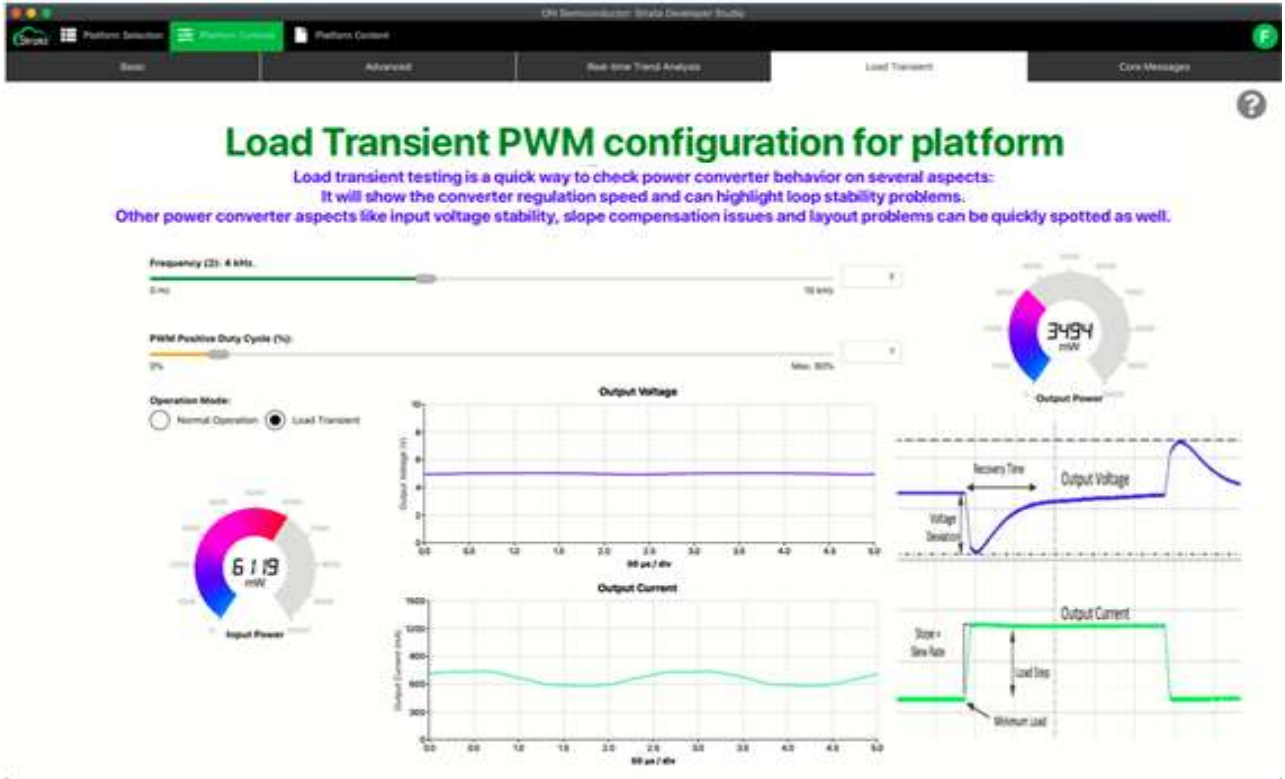

- Core Control Interface provides the ability to capture notification serial data easily for subsequent analysis and debugging. Every action is logged with all relevant data, which allows users to bring data directly into the cells of an Excel spreadsheet.

Message notifications coming from CoreInterface

Data Acquisition Clear Data

PID	Vin(V)	lin(A)	Vout(V)	Iout(A)	Efficacy (%)	Temp (°C)	Transient	Freq	Duty (%)	Pin(W)	Pout(W)	Pdis(W)
186: (PID)	18.400	0.354	4.970	0.734	55.042	42	false	0	0	6.514	3.648	2.976
187: (PID)	18.400	0.354	4.970	0.734	55.042	42	false	0	0	6.514	3.648	2.866
188: (PID)	18.400	0.354	4.970	0.734	55.042	42	false	0	0	6.514	3.648	2.866
189: (PID)	18.400	0.354	4.970	0.734	55.042	42	false	0	0	6.514	3.648	2.866
190: (PID)	18.400	0.354	4.970	0.734	55.042	42	false	0	0	6.514	3.648	2.866
191: (PID)	18.400	0.354	4.970	0.734	55.042	42	false	0	0	6.514	3.648	2.866
192: (PID)	18.400	0.354	4.970	0.734	55.042	42	false	0	0	6.514	3.648	2.866
193: (PID)	18.400	0.354	4.970	0.734	55.042	42	false	0	0	6.514	3.648	2.866
194: (PID)	18.400	0.354	4.970	0.734	56.006	42	false	0	0	6.514	3.648	2.866
195: (PID)	18.400	0.354	4.970	0.734	56.006	42	false	0	0	6.514	3.648	2.866
196: (PID)	18.400	0.354	4.970	0.734	56.006	42	false	0	0	6.514	3.648	2.866
197: (PID)	18.400	0.354	4.970	0.734	56.006	42	false	0	0	6.514	3.648	2.866
198: (PID)	18.400	0.354	4.970	0.734	56.006	42	false	0	0	6.514	3.648	2.866
199: (PID)	18.400	0.348	4.970	0.734	56.006	42	false	0	0	6.514	3.648	2.866
200: (PID)	18.400	0.348	4.970	0.734	56.006	42	false	0	0	6.403	3.648	2.866
201: (PID)	18.400	0.348	4.970	0.734	56.006	42	false	0	0	6.403	3.648	2.755
202: (PID)	18.400	0.348	4.960	0.734	56.006	42	false	0	0	6.403	3.648	2.755
203: (PID)	18.400	0.348	4.960	0.734	56.006	42	false	0	0	6.403	3.641	2.755
204: (PID)	18.400	0.348	4.960	0.734	56.006	42	false	0	0	6.403	3.641	2.762
205: (PID)	18.400	0.348	4.960	0.731	56.006	42	false	0	0	6.403	3.641	2.762
206: (PID)	18.400	0.348	4.960	0.731	56.006	42	false	0	0	6.403	3.626	2.762
207: (PID)	18.400	0.348	4.960	0.731	56.006	42	false	0	0	6.403	3.626	2.777
208: (PID)	18.400	0.348	4.960	0.731	56.624	42	false	0	0	6.403	3.626	2.777
209: (PID)	18.400	0.348	4.960	0.731	56.624	42	false	0	0	6.403	3.626	2.777
210: (PID)	18.390	0.348	4.960	0.731	56.624	42	false	0	0	6.403	3.626	2.777
211: (PID)	18.390	0.348	4.960	0.731	56.624	42	false	0	0	6.400	3.626	2.777
212: (PID)	18.390	0.348	4.960	0.731	56.624	42	false	0	0	6.400	3.626	2.774
213: (PID)	18.390	0.342	4.960	0.731	56.624	42	false	0	0	6.400	3.626	2.774
214: (PID)	18.390	0.342	4.960	0.731	56.624	42	false	0	0	6.289	3.626	2.774
215: (PID)	18.390	0.342	4.960	0.731	56.624	42	false	0	0	6.289	3.626	2.663
216: (PID)	18.390	0.342	4.950	0.731	56.624	42	false	0	0	6.289	3.626	2.663
217: (PID)	18.390	0.342	4.950	0.731	56.624	42	false	0	0	6.289	3.618	2.663
218: (PID)	18.390	0.342	4.950	0.731	56.624	42	false	0	0	6.289	3.618	2.671
219: (PID)	18.390	0.342	4.950	0.728	56.624	42	false	0	0	6.289	3.618	2.671
220: (PID)	18.390	0.342	4.950	0.728	56.624	42	false	0	0	6.289	3.604	2.671
221: (PID)	18.390	0.342	4.950	0.728	56.624	42	false	0	0	6.289	3.604	2.685
222: (PID)	18.390	0.342	4.950	0.728	57.297	42	false	0	0	6.289	3.604	2.685
223: (PID)	18.390	0.342	4.950	0.728	57.297	42	false	0	0	6.289	3.604	2.685

Hello Strata Power. LV DC-DC Ecosystem. User Guide

Table 1

Vin(V):	Iin(A):	Vout(V):	Iout(A):	Efficy.(η)(%)	Pin(W):	Pout(W):	Pdis(W):
18.480	291	5.040	525	49.203	5.378	2.646	2.732
18.480	291	5.040	525	49.203	5.378	2.646	2.732
18.480	291	5.040	525	49.203	5.378	2.646	2.732
18.480	291	5.040	525	49.203	5.378	2.646	2.732
18.480	291	5.040	525	49.203	5.378	2.646	2.732
18.480	291	5.040	525	49.203	5.378	2.646	2.732
18.480	291	5.040	525	49.203	5.378	2.646	2.732
18.480	291	5.040	525	49.203	5.378	2.646	2.732
18.490	291	5.040	525	49.203	5.378	2.646	2.732
18.490	291	5.040	525	49.203	5.381	2.646	2.732
18.490	291	5.040	525	49.203	5.381	2.646	2.735
18.490	294	5.040	525	49.203	5.436	2.646	2.735
18.490	294	5.040	525	49.203	5.436	2.646	2.790
18.490	294	5.050	525	49.203	5.436	2.646	2.790
18.490	294	5.050	525	49.203	5.436	2.651	2.790
18.490	294	5.050	525	49.203	5.436	2.651	2.785
18.490	294	5.050	525	49.203	5.436	2.651	2.785
18.490	294	5.050	525	49.203	5.436	2.651	2.785
18.490	294	5.050	525	48.772	5.436	2.651	2.785
18.490	294	5.050	525	48.772	5.436	2.651	2.785
18.480	294	5.050	525	48.772	5.433	2.651	2.785
18.480	294	5.050	525	48.772	5.433	2.651	2.782
18.480	294	5.050	525	48.772	5.433	2.651	2.782
18.480	294	5.050	525	48.772	5.433	2.651	2.782
18.480	294	5.060	525	48.772	5.433	2.651	2.782
18.480	294	5.060	525	48.772	5.433	2.656	2.782
18.480	294	5.060	525	48.772	5.433	2.656	2.777
18.480	294	5.060	525	48.772	5.433	2.656	2.777
18.480	294	5.060	525	48.772	5.433	2.656	2.777
18.480	294	5.060	525	48.895	5.433	2.656	2.777
18.490	294	5.060	525	48.895	5.433	2.656	2.777
18.490	294	5.060	525	48.895	5.436	2.656	2.780
18.490	294	5.060	525	48.895	5.436	2.656	2.780
18.490	294	5.060	525	48.895	5.436	2.656	2.780
18.490	294	5.060	525	48.895	5.436	2.656	2.780
18.490	294	5.060	525	48.895	5.436	2.656	2.780
18.490	294	5.060	525	48.895	5.436	2.656	2.780
18.490	294	5.060	525	48.895	5.436	2.656	2.780
18.490	294	5.060	525	48.868	5.436	2.656	2.780
18.490	294	5.060	525	48.868	5.436	2.656	2.780
18.490	294	5.060	525	48.868	5.436	2.656	2.780
18.490	294	5.060	525	48.868	5.436	2.656	2.780
18.490	294	5.060	525	48.868	5.436	2.656	2.780
18.490	294	5.060	525	48.868	5.436	2.656	2.780

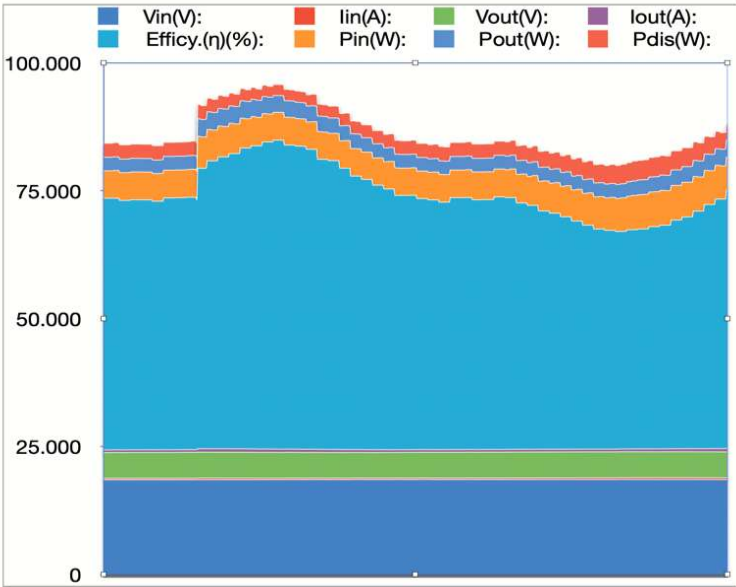

7. To look at the collateral provided with the EVB, click on the “Platform Content” tab at the top of the screen.



8. Schematic Module Evaluation Board

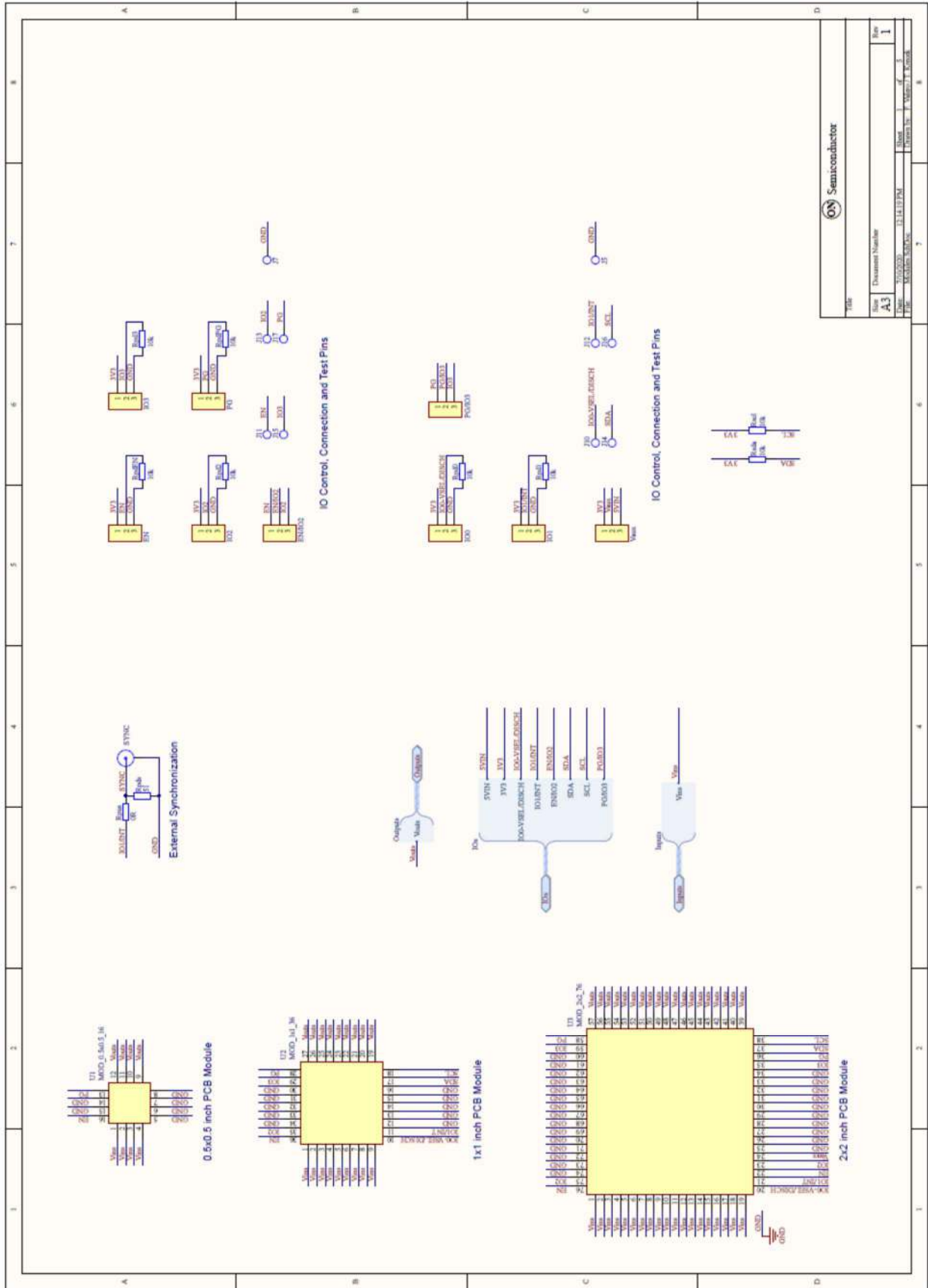

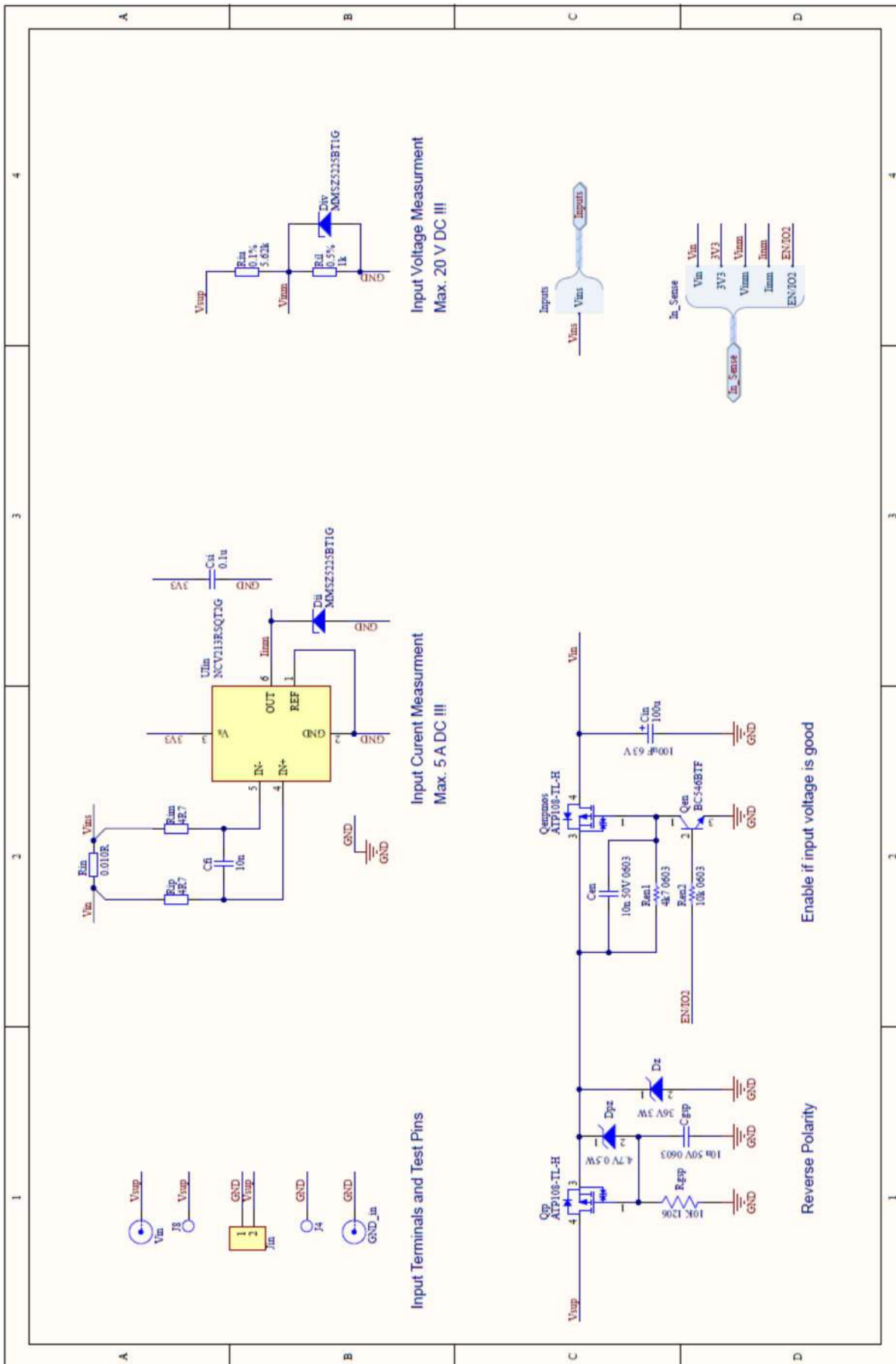

Hello Strata Power. LV DC-DC Ecosystem. User Guide

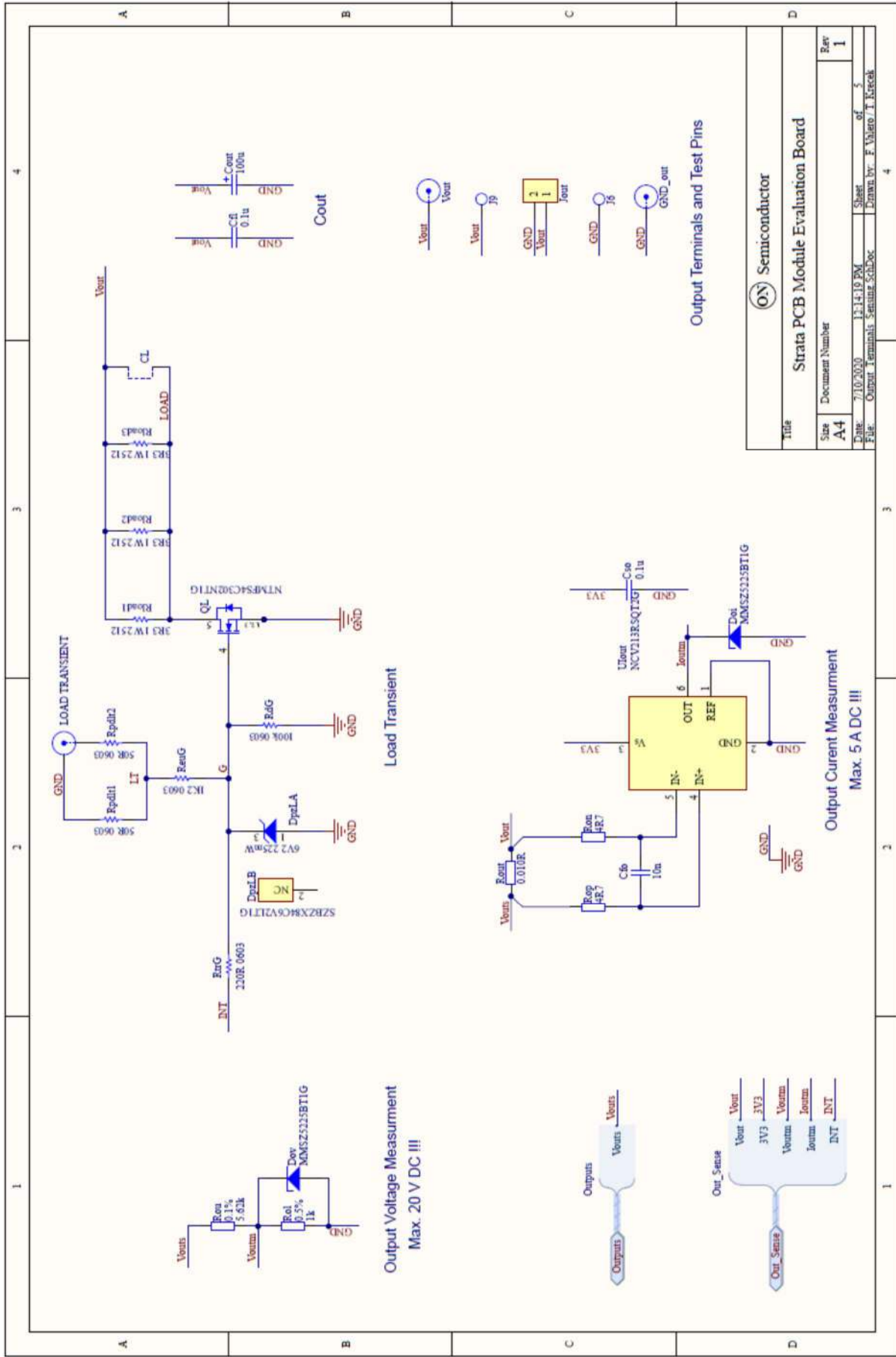

Hello Strata Power. LV DC-DC Ecosystem. User Guide

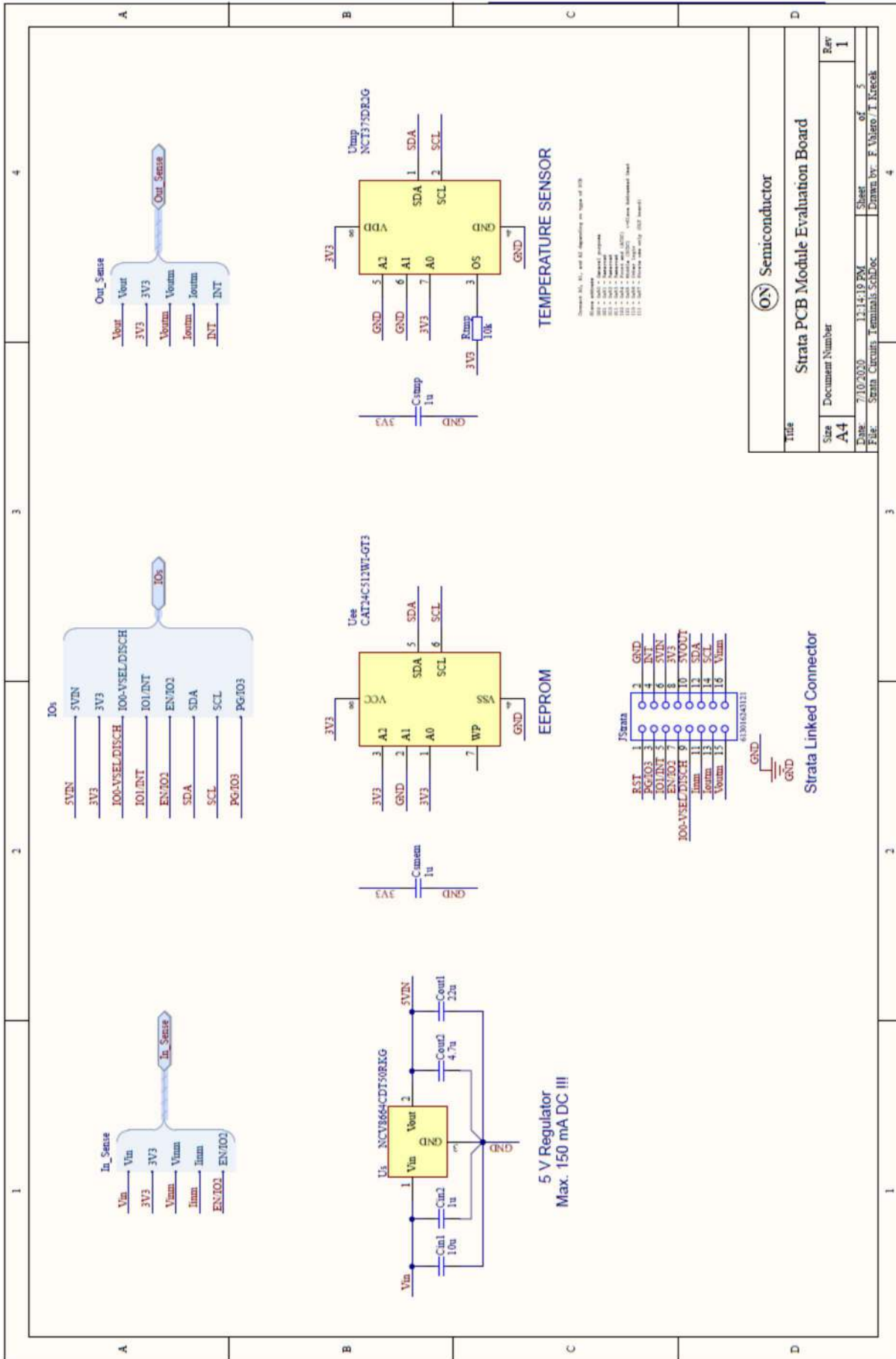

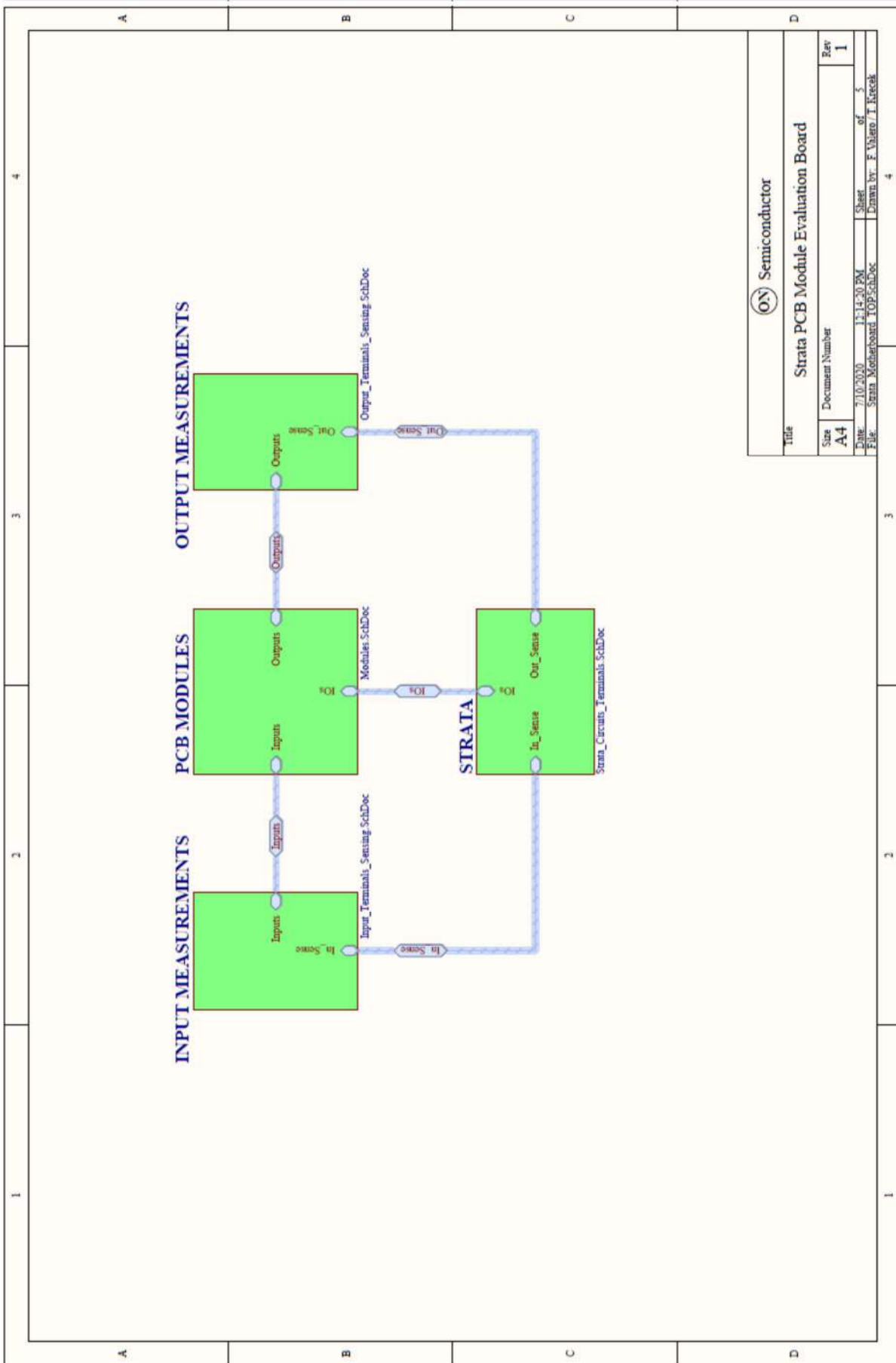

Hello Strata Power. LV DC-DC Ecosystem. User Guide

ON Semiconductor and the ON Semiconductor logo are trademarks of Semiconductor Components Industries, LLC dba ON Semiconductor or its subsidiaries in the United States and/or other countries. ON Semiconductor owns the rights to a number of patents, trademarks, copyrights, trade secrets, and other intellectual property. A listing of ON Semiconductor's product/patent coverage may be accessed at www.onsemi.com/site/pdf/Patent-Marking.pdf. ON Semiconductor is an Equal Opportunity/Affirmative Action Employer. This literature is subject to all applicable copyright laws and is not for resale in any manner.

The evaluation board/kit (research and development board/kit) (hereinafter the "board") is not a finished product and is as such not available for sale to consumers. The board is only intended for research, development, demonstration and evaluation purposes and should as such only be used in laboratory/development areas by persons with an engineering/technical training and familiar with the risks associated with handling electrical/mechanical components, systems and subsystems. This person assumes full responsibility/liability for proper and safe handling. Any other use, resale or redistribution for any other purpose is strictly prohibited.

The board is delivered "AS IS" and without warranty of any kind including, but not limited to, that the board is production-worthy, that the functions contained in the board will meet your requirements, or that the operation of the board will be uninterrupted or error free. ON Semiconductor expressly disclaims all warranties, express, implied or otherwise, including without limitation, warranties of fitness for a particular purpose and non-infringement of intellectual property rights.

ON Semiconductor reserves the right to make changes without further notice to any board.

You are responsible for determining whether the board will be suitable for your intended use or application or will achieve your intended results. Prior to using or distributing any systems that have been evaluated, designed or tested using the board, you agree to test and validate your design to confirm the functionality for your application. Any technical, applications or design information or advice, quality characterization, reliability data or other services provided by ON Semiconductor shall not constitute any representation or warranty by ON Semiconductor, and no additional obligations or liabilities shall arise from ON Semiconductor having provided such information or services.

The boards are not designed, intended, or authorized for use in life support systems, or any FDA Class 3 medical devices or medical devices with a similar or equivalent classification in a foreign jurisdiction, or any devices intended for implantation in the human body. Should you purchase or use the board for any such unintended or unauthorized application, you shall indemnify and hold ON Semiconductor and its officers, employees, subsidiaries, affiliates, and distributors harmless against all claims, costs, damages, and expenses, and reasonable attorney fees arising out of, directly or indirectly, any claim of personal injury or death associated with such unintended or unauthorized use, even if such claim alleges that ON Semiconductor was negligent regarding the design or manufacture of the board.

This evaluation board/kit does not fall within the scope of the European Union directives regarding electromagnetic compatibility, restricted substances (RoHS), recycling (WEEE), FCC, CE or UL, and may not meet the technical requirements of these or other related directives.

FCC WARNING – This evaluation board/kit is intended for use for engineering development, demonstration, or evaluation purposes only and is not considered by ON Semiconductor to be a finished end product fit for general consumer use. It may generate, use, or radiate radio frequency energy and has not been tested for compliance with the limits of computing devices pursuant to part 15 of FCC rules, which are designed to provide reasonable protection against radio frequency interference. Operation of this equipment may cause interference with radio communications, in which case the user shall be responsible, at its expense, to take whatever measures may be required to correct this interference.

ON Semiconductor does not convey any license under its patent rights nor the rights of others.

LIMITATIONS OF LIABILITY: ON Semiconductor shall not be liable for any special, consequential, incidental, indirect or punitive damages, including, but not limited to the costs of requalification, delay, loss of profits or goodwill, arising out of or in connection with the board, even if ON Semiconductor is advised of the possibility of such damages. In no event shall ON Semiconductor's aggregate liability from any obligation arising out of or in connection with the board, under any theory of liability, exceed the purchase price paid for the board, if any.

PUBLICATION ORDERING INFORMATION

LITERATURE FULLFILLMENT:

Literature Distribution Center for ON Semiconductor 19521 E.
32nd Pkwy, Aurora, Colorado 80011 USA

Phone: 303-675-2175 or 800-344-3860 Toll Free USA/Canada
Fax: 303-675-2176 or 800-344-3867 Toll Free USA/Canada
Email: orderlit@onsemi.com

N. American Technical Support:

800-282-9855 Toll Free USA/Canada

Europe, Middle East and Africa Technical Support:

Phone: 421 33 790 2910

ON Semiconductor Website:

<https://www.onsemi.com/>

Order Literature:

<https://www.onsemi.com/orderlit>

For additional information, please contact your local Sales Representative