

REVISIONS				DATE	DWN	APVD
P	LTR	DESCRIPTION				
	B	ECO-20-017853: G-CONTACT TAIL GOLD FLASH		18DEC2020	A.L	H.L

AS SHOWN: TYPE-1

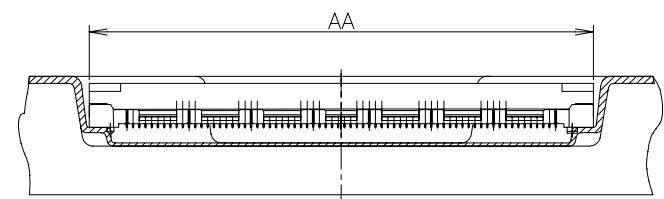

D-D (SCALE 2:1)

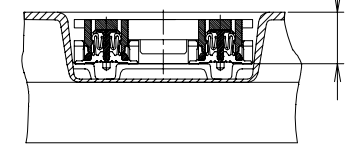

E-E (SCALE 2:1)

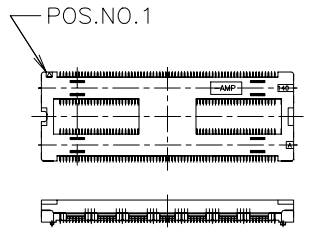
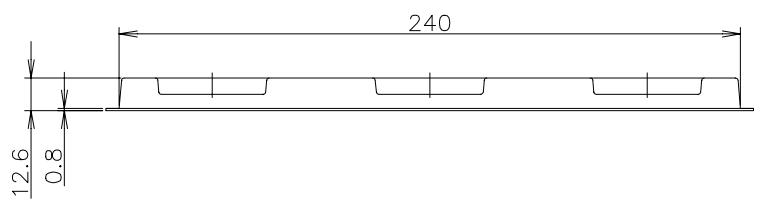
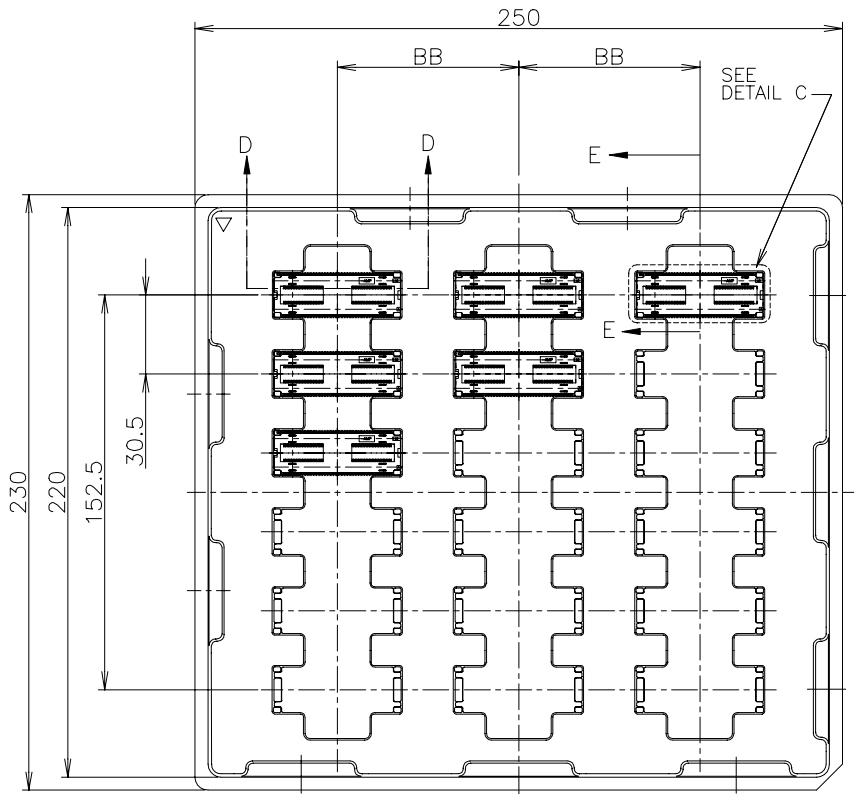
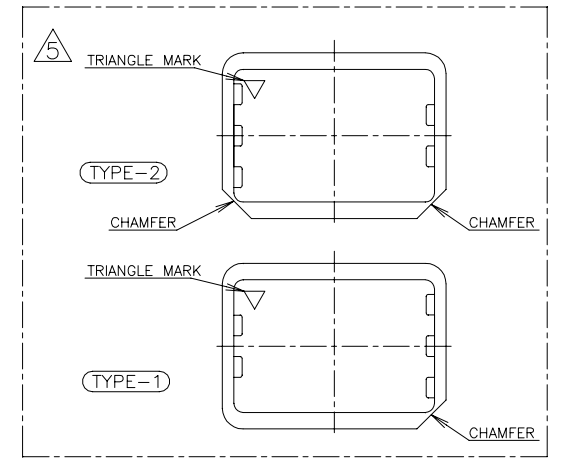

DETAIL C (SCALE 1:1)

SEALANT	TOOLING STATUS	ROW	QTY	BB	AA	POS.	PART NO.
SEALANT	NOT AVAILABLE	3	18	70	54.7	320	6-5353729-1
	NOT AVAILABLE	↑	↑	↑	48.7	280	6-↑-0
	NOT AVAILABLE	↓	↓	↓	42.7	240	5-↓-9
	NOT AVAILABLE	3	18	70	36.7	200	5-5353729-8
NON SEALANT	NOT AVAILABLE	3	18	70	54.7	320	1-5353729-1
	AVAILABLE	↑	↑	↑	48.7	280	1-↑-0
	NOT AVAILABLE	↓	↓	↓	42.7	240	↓-9
	NOT AVAILABLE	3	18	70	36.7	200	5353729-8

THIS DRAWING IS A CONTROLLED DOCUMENT.

DIMENSIONS: 單位: 耗 mm	TOLERANCES UNLESS OTHERWISE SPECIFIED: 一般公差	DWN LEO ZHOU 17NOV04	CHK STEVEN YAO 17NOV04
0 PLC ±-	1 PLC ±-	APVD I.ENOMOTO 17NOV04	NAME I.ENOMOTO
2 PLC ±-	3 PLC ±-	PRODUCT SPEC 108-60047	APPLICATION SPEC 取付適用規格
4 PLC ±-	ANGLES ±-	WEIGHT 114-5255	SIZE A3
MATERIAL 材料	FINISH 仕上	CAGE CODE 00779	DRAWING NO G=5353729

GENERAL TOLERANCE
一般公差

10 ≥	±0.2
30 ≥	>10: ±0.25
100 ≥	>30: ±0.3
ANGLES: ±3°	



SOFT TRAY ASSY
FH 0.6BTB CONNECTOR
REC 4H W/G-CONT 2ROW TYPE

REVISIONS					
変更					
P	LTR	DESCRIPTION	DATE	DWN	APVD
-	-	SEE SHEET 1	-	-	-

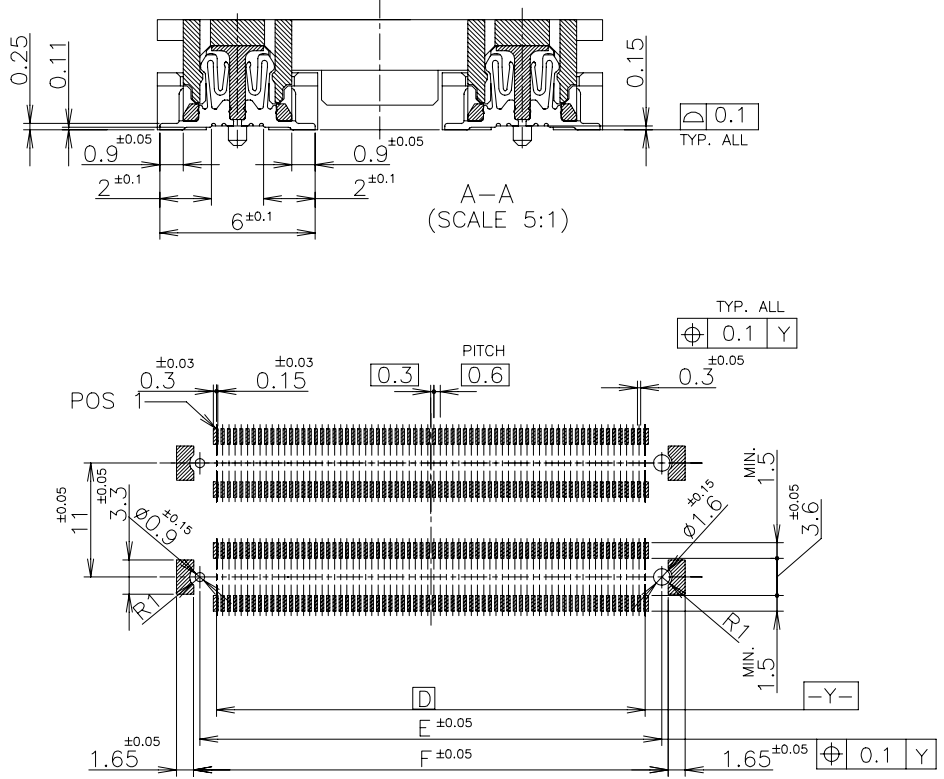
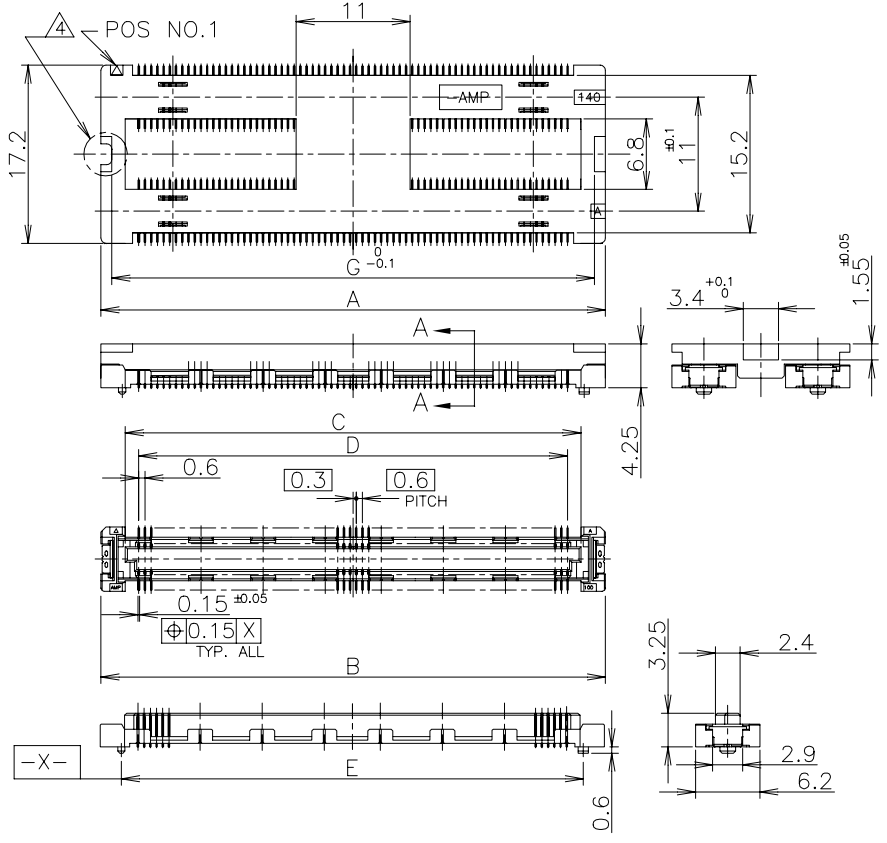

REFERENCE P.C. BOARD LAYOUT

- ① MATERIAL ; HOUSING : HIGH TEMP THERMO PLASTIC UL94V-0
CONTACT : COPPER ALLOY
- ② FINISH ; UNDER PL Ni 0.0013mm MIN ALL OVER.
CONTACT AREA 0.0002 MIN Au PL.
SOLDERING AREA
SIGNAL POS: 0.00005 MIN Au PL.
GROUND POS: 0.00005 MIN Au PL.
- ③ THIS POSITION IS GROUND CIRCUIT.
- ④ CAP HOUSING FOR ONLY 280P HAS THIS ORIENTATION FEATURE.
- ⑤ TRAY TYPE-1 AND TYPE-2 MUST BE PILED UP BY TURNS.
(REFER TO PACKING SPECIFICATIONS)

NOT AVAILABLE	52.6	51.8	50.6	47.4	50	54.7	54.7	320	1-5353729-1 & 6-5353729-1
AVAILABLE	46.6	45.8	44.6	41.4	44	48.7	48.7	280	1- -0 & 6- -0
NOT AVAILABLE	40.6	39.8	38.6	35.4	38	42.7	42.7	240	-9 & 5- -9
AVAILABLE	34.6	33.8	32.6	29.4	32	36.7	36.7	200	5353729-8 & 5-5353729-8
TOOLING STATUS	G	F	E	D	C	B	A	POS	PART NO.

THIS DRAWING IS A CONTROLLED DOCUMENT.

DIMENSIONS: 单位: 耗 mm

TOLERANCES UNLESS OTHERWISE SPECIFIED: 一般公差

0 PLC ± -
1 PLC ± -
2 PLC ± -
3 PLC ± -
4 PLC ± -
ANGLES ± -

FINISH 仕上

DWN
CHK
APVD

PRODUCT SPEC 製品規格
APPLICATION SPEC 取付適用規格

WEIGHT

CUSTOMER DRAWING

NAME 名称
SOFT TRAY ASSY
FH 0.6BTB CONNECTOR
REC 4H W/G-CONT 2ROW TYPE

SIZE A3 CAGE CODE 00779 DRAWING NO. 番号 5353729

RESTRICTED TO

SCALE 尺度 2:1 SHEET 2 OF 3 REV B

TE Connectivity Ltd.

REVISIONS					
变更					
P	LTR	DESCRIPTION	DATE	DWN	APVD
-		SEE SHEET 1	-	-	-

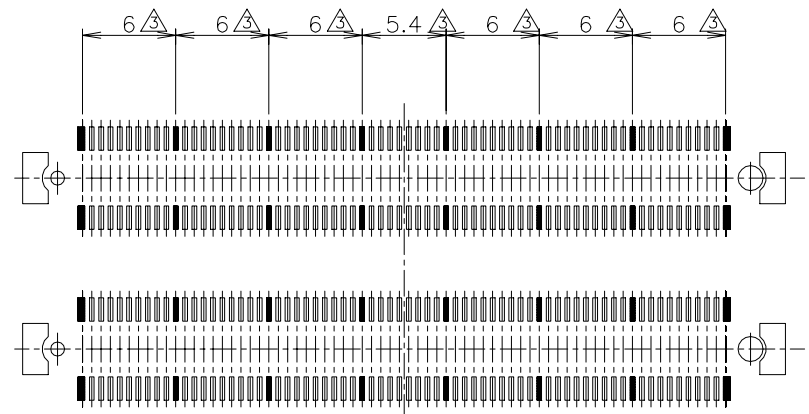

280P

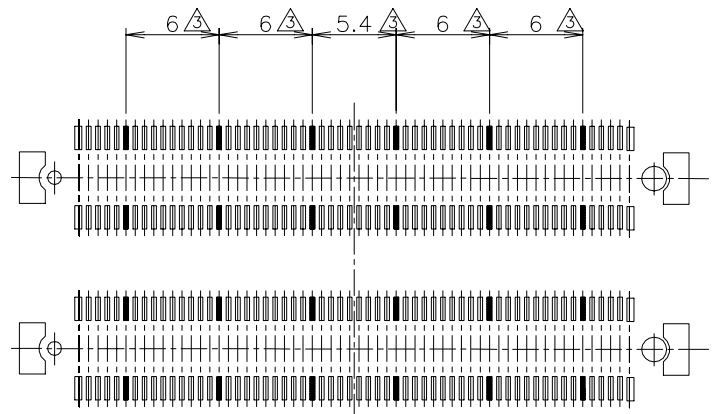

240P

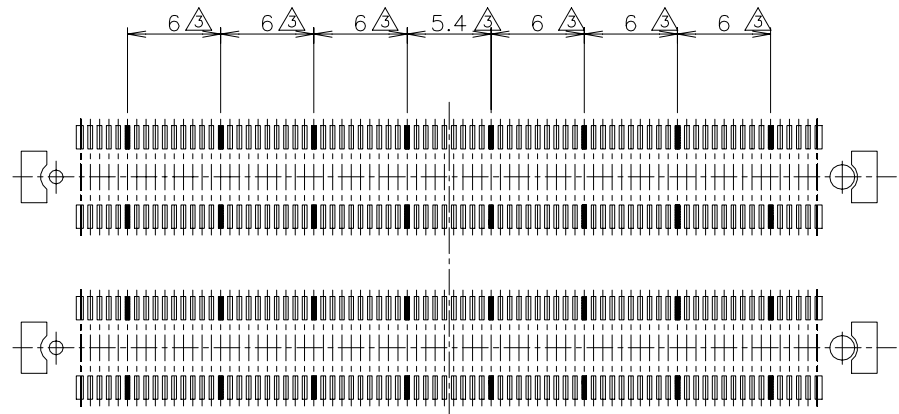

320P

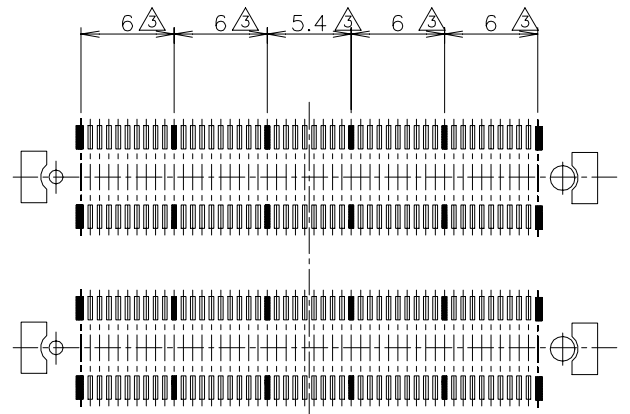

200P

THIS DRAWING IS A CONTROLLED DOCUMENT.		DWN		TE Connectivity Ltd.	
DIMENSIONS: 單位: 耗 mm		CHK			
TOLERANCES UNLESS OTHERWISE SPECIFIED: 一般公差		APVD		NAME 名称	
0 PLC ± -		PRODUCT SPEC 製品規格		SOFT TRAY ASSY	
1 PLC ± -		APPLICATION SPEC 取付適用規格		FH 0.6BTB CONNECTOR	
2 PLC ± -		WEIGHT		REC 4H W/G-CONT 2ROW TYPE	
3 PLC ± -		SIZE		DRAWING NO	
4 PLC ± -		A3		00779	
ANGLES ± -		CAGE CODE		G=5353729	
FINISH 仕上		CUSTOMER DRAWING		RESTRICTED TO	
MATERIAL 材料		SCALE 尺度 3:1		SHEET 3 OF 3	
①				REV B	