

NOTES:

1. ROHS COMPLIANT
2. HEADER: DAP (DIALLYL PHTHALATE) WITH FLAMMABILITY RATING UL 94V-0 OR BETTER.
3. STORAGE TEMPERATURE: -20°C TO +125°C
4. COMPLIANCE TO J-STD:
  - A. J-STD-002: SOLDERABILITY AT 245°C REFLOW PROFILE
  - B. J-STD-020: LEVEL 3, NO MOISTURE SENSITIVE
  - C. J-STD-075: R7, 245°C MAXIMUM THROUGH REFLOW SOLDER
5. TO ORDER TAPE & REEL PACKAGING ADD A "T" SUFFIX TO THE PART NUMBER(i.e H1112NL BECOMES H1112NLT).

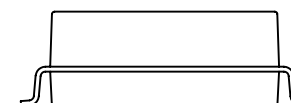
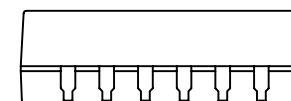
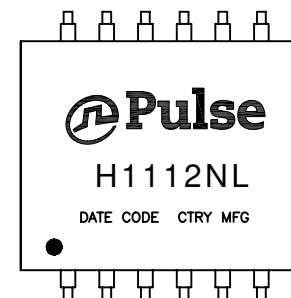

FINAL OUTLINE

© Copyright, 2014. Pulse Electronics Corp. All rights reserved. Pulse confidential & proprietary. (08/06/14)

PRODUCT DESCRIPTION	TLA DRAWING	PS DRAWING	SHEET	PART NO.	DATASHEET REV.
MDL,SIN,100D,1:1,SM,TU	H1112NL-11	PS-0023.001-D	1 OF 3	H1112NL	A

ELECTRICAL CHARACTERISTICS AT +25°C UNLESS OTHER SPECIFIED  
MEETS IEEE 802.3 SPECIFICATION

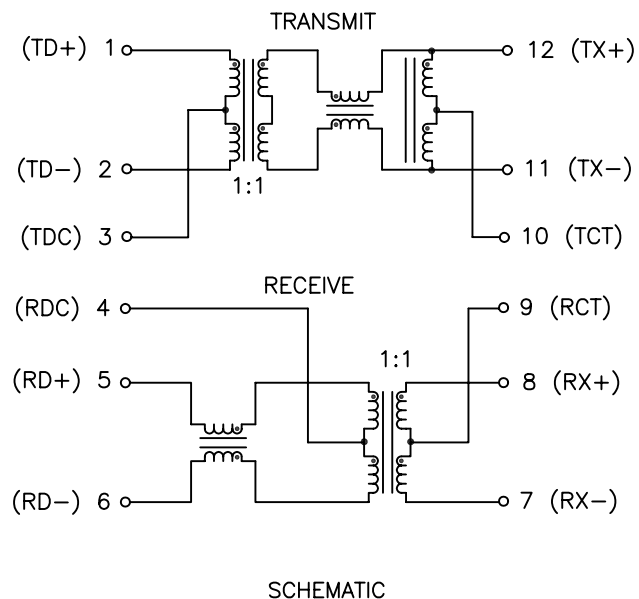

PARAMETER	SPECIFICATIONS		
OPERATING TEMP	0°C – 70 °C		
TURNS RATIO	1 : 1 ±2%		
POLARITY	PER SCHEMATIC		
INSERTION LOSS	100 KHz	1–125 MHz	
	-1.2 dB MAX	-0.2-0.002*f <sup>1.4</sup> dB MAX	
RETURN LOSS (Z OUT = 100 OHM ±15%)	.1–30 MHz	30–60 MHz	60–80 MHz
	-16 dB MIN	-10+20*LOG <sub>10</sub> (f/60 MHz) dB MIN	-10 dB MIN
INDUCTANCE (OCL) (MEDIA SIDE, 0°C–70°C)	350 µH MIN (MEASURED AT 100 KHz, 100 mVRMS) (AND WITH 8 mA DC BIAS)		
CROSSTALK, ADJACENT CHANNELS	1 MHz	10–100 MHz	
	-50 dB MIN	-50+17*LOG <sub>10</sub> (f/10) dB MIN	
COMMON MODE REJECTION RATIO	2 MHz	30–200 MHz	
	-50 dB MIN	-15+20*LOG <sub>10</sub> (f/200) dB MIN	
DC RESISTANCE 1/2 WINDING	.60 OHMS MAX		
DC RESISTANCE IMBALANCE	±.065 OHMS MAX (CENTER TAP SYMMETRY)		
INPUT – OUTPUT ISOLATION	1500 VRMS MIN @ 60 SECONDS		

NOTE: f IS FREQUENCY IN MHz.

© Copyright, 2014. Pulse Electronics Corp. All rights reserved. Pulse confidential & proprietary. (08/06/14)

PRODUCT DESCRIPTION	TLA DRAWING	PS DRAWING	SHEET	PART NO.	DATASHEET REV.
MDL,SIN,100D,1:1,SM,TU	H1112NL-11	PS-0023.001-D	2 OF 3	H1112NL	A

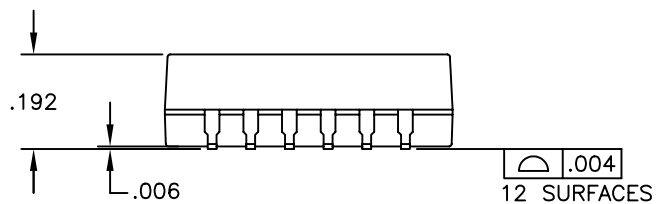
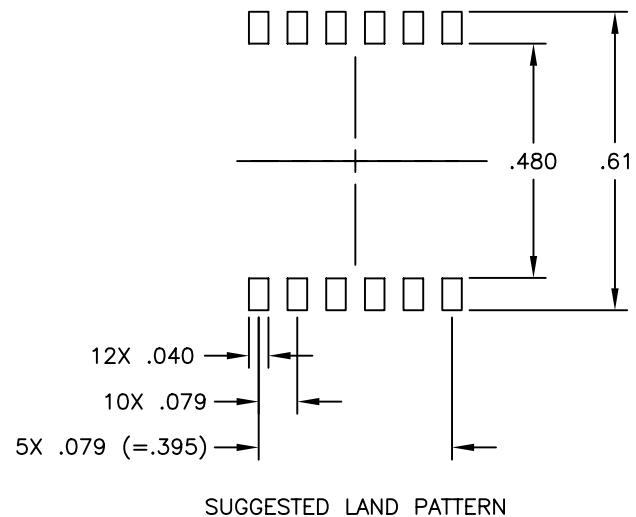
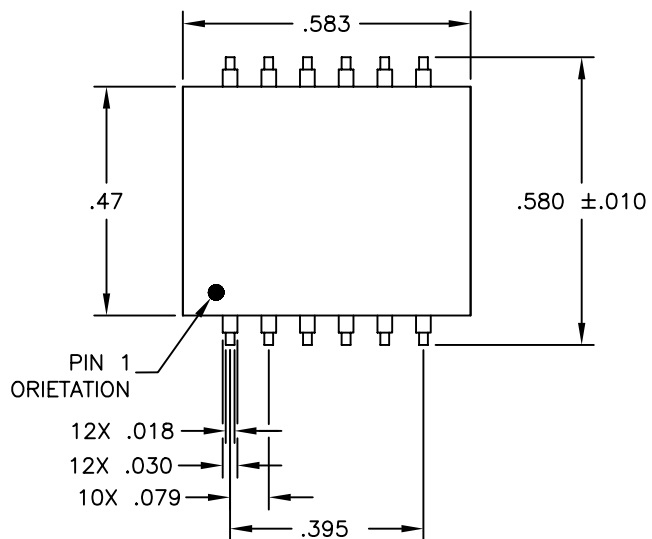

DIMENSIONS ARE IN INCHES WITH THE FOLLOWING  
TOLERANCES:  
.XX= ±.01  
.XXX= ±.005

© Copyright, 2014. Pulse Electronics Corp. All rights reserved. Pulse confidential & proprietary. (08/06/14)

PRODUCT DESCRIPTION	TLA DRAWING	PS DRAWING	SHEET	PART NO.	DATASHEET REV.
MDL,SIN,100D,1:1,SM,TU	H1112NL-11	PS-0023.001-D	3 OF 3	H1112NL	A