



circuit breaker 3VA5 UL frame 125 breaking capacity class H 65kA @ 480 V 2-pole, line protection TM210, FTFM, In=70A overload protection Ir=70A fixed short-circuit protection li=10 x In cable connection on both sides

Model	
product brand name	SENTRON
product designation	Molded-case circuit breaker
product designation / according to UL file	HEAS
Product version	System protection
design of the load switch / according to UL 489 / Heating, Air Conditioning, and Refrigeration circuit breaker (HACR Type)	Yes
design of the load switch / according to UL 489 / High-Intensity-Discharge circuit breaker (HID Type)	No
design of the load switch / according to UL 489 / Switching Duty circuit breaker (SWD Type)	No
design of the overcurrent release	TM210
protection function of the overcurrent release	LI
number of poles	2
General technical data	
insulation voltage / rated value	600 V
Max. rated operational voltage Ue with DC	250 V
operating voltage / at AC / rated value	415 V
power loss [W] / maximum	12.2 W
Active power loss / for rated value of the current / at AC / in hot operating state / per pole	6.1 W
mechanical service life (switching cycles) / typical	20 000
Electrical endurance (switching cycles) / at AC-1 / at 380/415 V 50/60 Hz	8 000
Electrical endurance (switching cycles) / at AC-1 / at 690 V 50/60 Hz	4 000
electrical endurance (switching cycles) / at 480 V	8 000
electrical endurance (switching cycles) / at 600 V	4 000
Neutral conductors / upgradeable/retrofitable	No
ground-fault monitoring version	without
product function	
• communication function	No
• other measurement function	No
Net Weight	0.668 kg
Current	
marking / according to UL 489 / 100%-rated breaker	No
operational current	
• at 40 °C	70 A
• at 45 °C	69 A
• at 50 °C	68 A
• at 55 °C	67 A
• at 60 °C	66 A

- at 65 °C
- at 70 °C

65 A
64 A

Switching capacity according to IEC 60947

switching capacity class of the circuit breaker	H
breaking capacity maximum short-circuit current (I _{cu})	
• at 240 V	150 kA
• at 415 V	70 kA
breaking capacity operating short-circuit current (I _{cs})	
• at 240 V	150 kA
• at 415 V	70 kA
short-circuit current making capacity (I _{cm})	
• at 240 V	330 kA
• at 415 V	154 kA
design of short-circuit protection	For switching power values in DC networks, see the 3VA molded case circuit breaker device manual; link to be found under Service & Support in the last chapter

Switching capacity according to UL 489

breaking capacity current	
• at 240 V	150 kA
• at 480 V	65 kA
• at 600 Y/347 V	25 kA

Adjustable parameters

product feature / for L-tripping / selectable characteristic function	No
type of value list setting current (I _r) / for L-tripping / with I _{2t} characteristic	Fest
reference value setting current (I _r) / for L-tripping / with I _{2t} characteristic	x I _n
set values setting current (I _r) / for L-tripping / with I _{2t} characteristic	1
adjustable response factor setting current (I _r) / for L-tripping / with I _{2t} characteristic / minimum	1
adjustable response factor setting current (I _r) / for L-tripping / with I _{2t} characteristic / maximum	1
adjustable response value setting current (I _r) / of the L-trip / with I _{2t} characteristic / minimum	70 A
adjustable response value setting current (I _r) / of the L-trip / with I _{2t} characteristic / maximum	70 A
type of value list delay time (t _r) / for L-tripping / with I _{2t} characteristic	Fest
reference value delay time (t _r) / for L-tripping / with I _{2t} characteristic	s
set values delay time (t _r) / for L-tripping / with I _{2t} characteristic	1
adjustable response value delay time (t _r) / for L-tripping / with I _{2t} characteristic / minimum	1 s
adjustable response value delay time (t _r) / for L-tripping / with I _{2t} characteristic / maximum	1 s
product feature / for S-tripping / independent of direction / selectable characteristic function	No
product feature / for I-tripping / can be switched on/off	No
design of I-trip / adjustable	No
reference value setting current (I _i) / for I-tripping	x I _n
set values setting current (I _i) / for I-tripping	10
adjustable response factor setting current (I _i) / for I-tripping / minimum	10
adjustable response factor setting current (I _i) / for I-tripping / maximum	10
adjustable response value setting current (I _i) / for I-tripping / minimum	700 A
adjustable response value setting current (I _i) / for I-tripping / maximum	700 A
product feature / for G-tripping / selectable characteristic function	No
product feature / with neutral conductor protection / can be switched on/off	No
product feature / with neutral conductor protection / adjustable	Yes

type of value list setting current (InN) / for N-tripping	St
reference value setting current (InN) / for N-tripping	x In
adjustable absolute value setting current (InN) / for N-tripping / minimum	0 A
adjustable absolute value setting current (InN) / for N-tripping / maximum	0 A
tripping characteristic / of the lower tolerance band	AK_3VA5_1_70A_TM2_SuMuH_uT
tripping characteristic / of the upper tolerance band	AK_3VA5_1_70A_TM2_SuMuH_oT
let-through energy characteristic / at 240 V	DE_3VA5_1_70A_TM2_line_2p_240V
let-through energy characteristic / at 415 V	DE_3VA5_1_70A_TM2_line_2p_415V
type of value list setting current (Ii) / for I-tripping	Fest
tripping characteristic / of the let-through current characteristic / at 240 V	DS_3VA5_1_70A_TM2_line_2p_240V
tripping characteristic / of the let-through current characteristic / at 415 V	DS_3VA5_1_70A_TM2_line_2p_415V
Adjustable response value current / I _g min.	70 A
adjustable current response value current / of the current-dependent overload release / full-scale value	70 A
Ground fault protection / tripping switchable / I _{2t} =ON/OFF	No

Mechanical Design

product component	
<ul style="list-style-type: none"> • undervoltage release • voltage trigger • trip indicator 	No
height [in]	5.51 in
Height	140 mm
width [in]	2 in
Type of connectable conductor cross-section, round conductor terminal, stranded	1 x (8 AWG - 3/0)
Width	50.8 mm
depth [in]	3.01 in
depth	76.5 mm

Connections

arrangement of electrical connectors / for main current circuit	Front connection
type of electrical connection / for main current circuit	circular conductor terminal on both sides

Auxiliary circuit

number of CO contacts / for auxiliary contacts	0
--	---

Accessories

product extension / optional / motor drive	No
--	----

Environmental conditions

protection class IP / on the front	IP40
ambient temperature	
<ul style="list-style-type: none"> • during operation / minimum • during operation / maximum • during storage / minimum • during storage / maximum 	-25 °C 70 °C -40 °C 80 °C

Certificates

reference code / according to IEC 81346-2	Q
---	---

General Product Approval



[Confirmation](#)



[Miscellaneous](#)

EMC	Declaration of Conformity	Marine / Shipping
-----	---------------------------	-------------------



Marine / Shipping

other



[Miscellaneous](#)

Further information

Information- and Downloadcenter (Catalogs, Brochures,...)

<http://www.siemens.com/lowvoltage/catalogs>

Industry Mall (Online ordering system)

<https://mall.industry.siemens.com/mall/en/en/Catalog/product?mlfb=3VA5170-6ED26-0AA0>

Service&Support (Manuals, Certificates, Characteristics, FAQs,...)

<https://support.industry.siemens.com/cs/ww/en/ps/3VA5170-6ED26-0AA0>

Image database (product images, 2D dimension drawings, 3D models, device circuit diagrams, ...)

http://www.automation.siemens.com/bilddb/cax_en.aspx?mlfb=3VA5170-6ED26-0AA0

CAx-Online-Generator

<http://www.siemens.com/cax>

Tender specifications

<http://www.siemens.com/specifications>

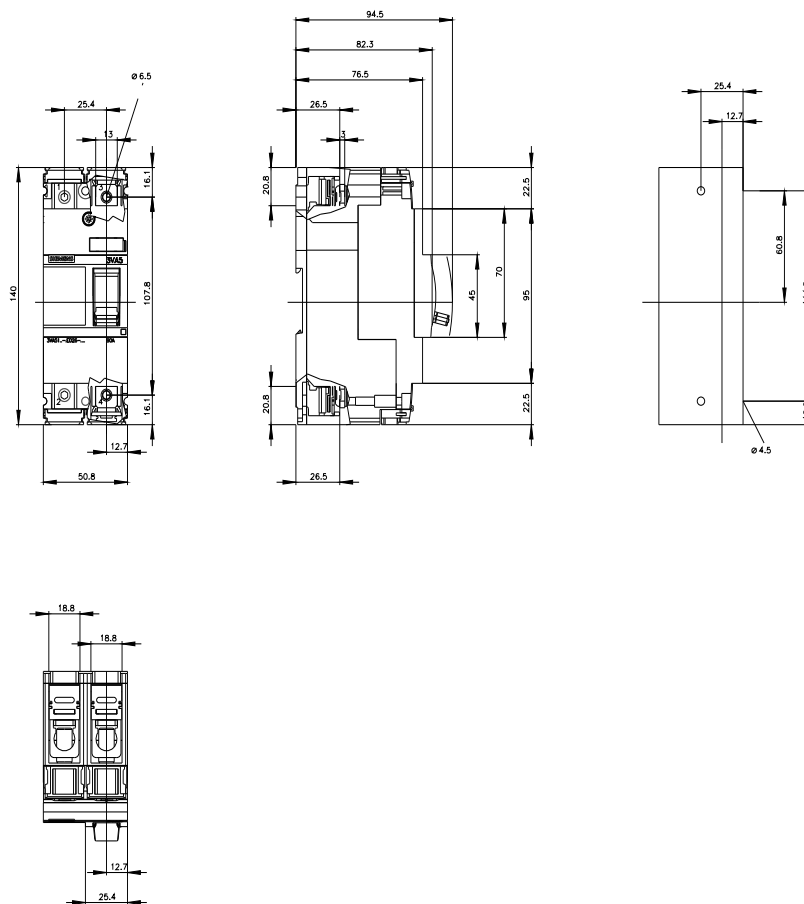

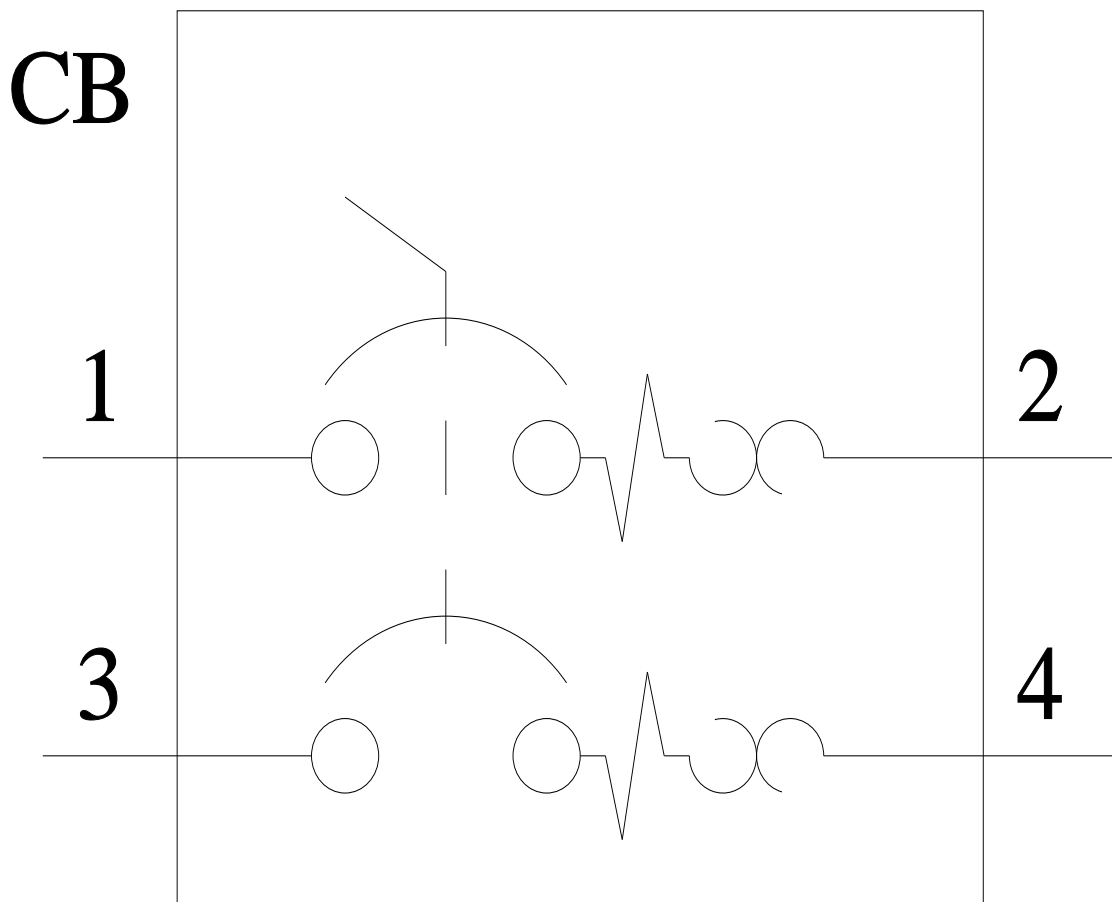
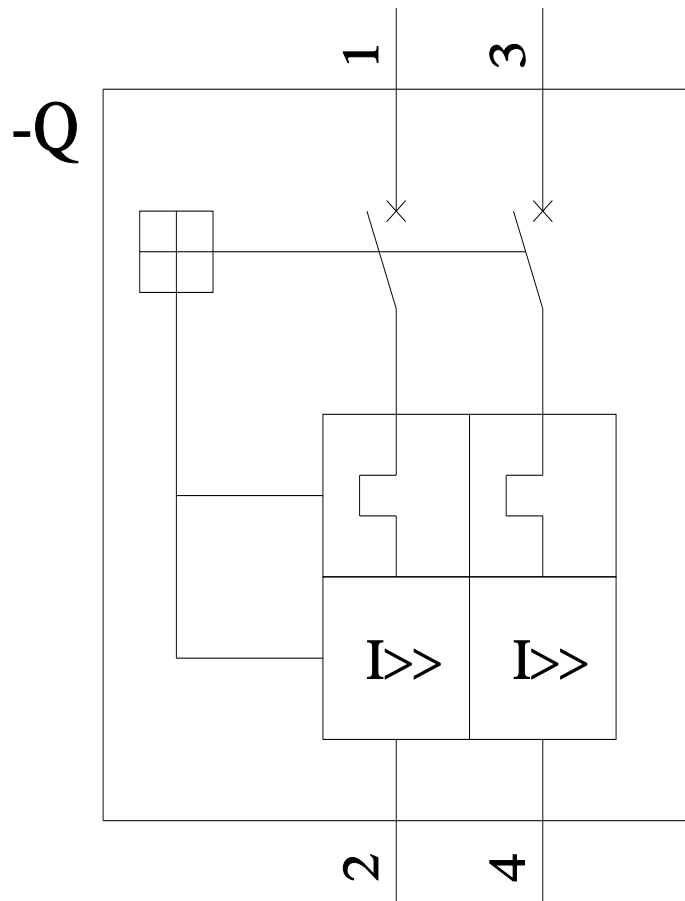

last modified:

7/15/2022 

