

# BLF8G22LS-200V; BLF8G22LS-200GV

Power LDMOS transistor

Rev. 3 — 1 September 2015

AMPLEON

Product data sheet

## 1. Product profile

### 1.1 General description

200 W LDMOS power transistor with improved video bandwidth for base station applications at frequencies from 2110 MHz to 2170 MHz.

**Table 1. Typical performance**

Typical RF performance at  $T_{case} = 25\text{ }^{\circ}\text{C}$  in a common source class-AB production test circuit, tested on straight lead device.

Test signal	f (MHz)	$I_{Dq}$ (mA)	$V_{DS}$ (V)	$P_{L(AV)}$ (W)	$G_p$ (dB)	$\eta_D$ (%)	ACPR <sub>5M</sub> (dBc)
2-carrier W-CDMA	2110 to 2170	2000	28	55	19.0	29	-30 <a href="#">[1]</a>

[1] 3GPP test model 1; 64 DPCH; PAR = 8.4 dB at 0.01 % probability on CCDF; 5 MHz carrier spacing.

### 1.2 Features and benefits

- Excellent ruggedness
- High efficiency
- Low  $R_{th}$  providing excellent thermal stability
- Designed for broadband operation
- Decoupling leads to enable improved video bandwidth (80 MHz typical)
- Lower output capacitance for improved performance in Doherty applications
- Designed for low memory effects providing excellent pre-distortability
- Internally matched for ease of use
- Integrated ESD protection
- Compliant to Directive 2002/95/EC, regarding Restriction of Hazardous Substances (RoHS)

### 1.3 Applications

- RF power amplifiers for base stations and multi carrier applications in the 2110 MHz to 2170 MHz frequency range

## 2. Pinning information

Table 2. Pinning

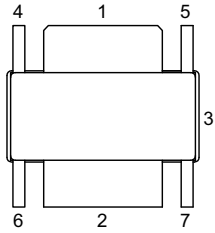
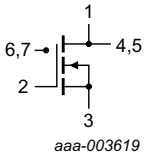
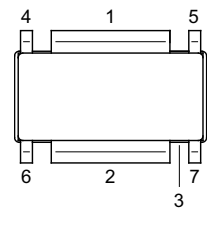
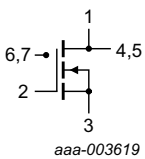
Pin	Description	Simplified outline	Graphic symbol
<b>BLF8G22LS-200V (SOT1244B)</b>			
1	drain		 aaa-003619
2	gate		
3	source		
4	video lead		
5	video lead		
6	n.c.		
7	n.c.		
<b>BLF8G22LS-200GV (SOT1244C)</b>			
1	drain		 aaa-003619
2	gate		
3	source		
4	video lead		
5	video lead		
6	n.c.		
7	n.c.		

[1] Connected to flange.

## 3. Ordering information

Table 3. Ordering information

Type number	Package		Version
	Name	Description	
BLF8G22LS-200V	-	earless flanged ceramic package; 6 leads	SOT1244B
BLF8G22LS-200GV	-	earless flanged ceramic package; 6 leads	SOT1244C

## 4. Limiting values

Table 4. Limiting values

In accordance with the Absolute Maximum Rating System (IEC 60134).

Symbol	Parameter	Conditions	Min	Max	Unit
$V_{DS}$	drain-source voltage		-	65	V
$V_{GS}$	gate-source voltage		-0.5	+13	V
$T_{stg}$	storage temperature		-65	+150	°C
$T_j$	junction temperature		-	225	°C

## 5. Thermal characteristics

Table 5. Thermal characteristics

Symbol	Parameter	Conditions	Typ	Unit
$R_{th(j-c)}$	thermal resistance from junction to case	$T_{case} = 80\text{ °C}; P_L = 45\text{ W}$	0.26	K/W

## 6. Characteristics

Table 6. DC characteristics

$T_j = 25\text{ °C}$ ; per section unless otherwise specified.

Symbol	Parameter	Conditions	Min	Typ	Max	Unit
$V_{(BR)DSS}$	drain-source breakdown voltage	$V_{GS} = 0\text{ V}; I_D = 3.3\text{ mA}$	65	-	-	V
$V_{GS(th)}$	gate-source threshold voltage	$V_{DS} = 10\text{ V}; I_D = 330\text{ mA}$	1.5	1.8	2.3	V
$I_{DSS}$	drain leakage current	$V_{GS} = 0\text{ V}; V_{DS} = 28\text{ V}$	-	-	4.2	$\mu\text{A}$
$I_{DSX}$	drain cut-off current	$V_{GS} = V_{GS(th)} + 3.75\text{ V}; V_{DS} = 10\text{ V}$	-	62.4	-	A
$I_{GSS}$	gate leakage current	$V_{GS} = 11\text{ V}; V_{DS} = 0\text{ V}$	-	-	420	nA
$g_{fs}$	forward transconductance	$V_{DS} = 10\text{ V}; I_D = 330\text{ mA}$	-	2.85	-	S
$R_{DS(on)}$	drain-source on-state resistance	$V_{GS} = V_{GS(th)} + 3.75\text{ V}; I_D = 11.55\text{ A}$	-	0.05	-	$\Omega$

Table 7. RF characteristics

Test signal: 2-carrier W-CDMA; PAR = 8.4 dB at 0.01 % probability on the CCDF; 3GPP test model 1; 1-64 DPCH;  $f_1 = 2112.5\text{ MHz}$ ;  $f_2 = 2117.5\text{ MHz}$ ;  $f_3 = 2162.5\text{ MHz}$ ;  $f_4 = 2167.5\text{ MHz}$ ; RF performance at  $V_{DS} = 28\text{ V}; I_{Dq} = 2000\text{ mA}; T_{case} = 25\text{ °C}$ ; unless otherwise specified; in a class-AB production test circuit, tested on straight lead device.

Symbol	Parameter	Conditions	Min	Typ	Max	Unit
$G_p$	power gain	$P_{L(AV)} = 55\text{ W}$	17.8	19.0	-	dB
$RL_{in}$	input return loss	$P_{L(AV)} = 55\text{ W}$	-	-13	-7	dB
$\eta_D$	drain efficiency	$P_{L(AV)} = 55\text{ W}$	26	29	-	%
$ACPR_{5M}$	adjacent channel power ratio (5 MHz)	$P_{L(AV)} = 55\text{ W}$	-	-30	-26	dBc

## 7. Test information

### 7.1 Ruggedness in class-AB operation

The BLF8G22LS-200V and BLF8G22LS-200GV are capable of withstanding a load mismatch corresponding to VSWR = 10 : 1 through all phases under the following conditions:  $V_{DS} = 28\text{ V}; I_{Dq} = 2000\text{ mA}; P_L = 200\text{ W (CW)}; f = 2110\text{ MHz}$ .

7.2 Impedance information

Table 8. Typical impedance information

$I_{DQ} = 2000 \text{ mA}$ ; main transistor  $V_{DS} = 28 \text{ V}$ .

$Z_S$  and  $Z_L$  defined in [Figure 1](#).

f (MHz)	$Z_S$ ( $\Omega$ )	$Z_L$ ( $\Omega$ )
<b>BLF8G22LS-200V</b>		
2110	0.84 – j4.17	2.07 – j2.39
2140	0.95 – j4.43	2.23 – j2.41
2170	1.12 – j5.68	2.53 – j2.40
<b>BLF8G22LS-200GV</b>		
2110	0.77 – j6.22	2.00 – j4.20
2140	0.80 – j6.34	2.33 – j4.00
2170	1.00 – j6.61	2.55 – j4.00

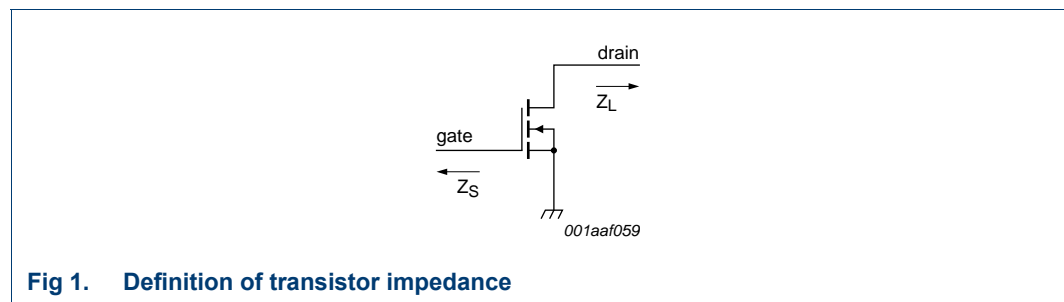
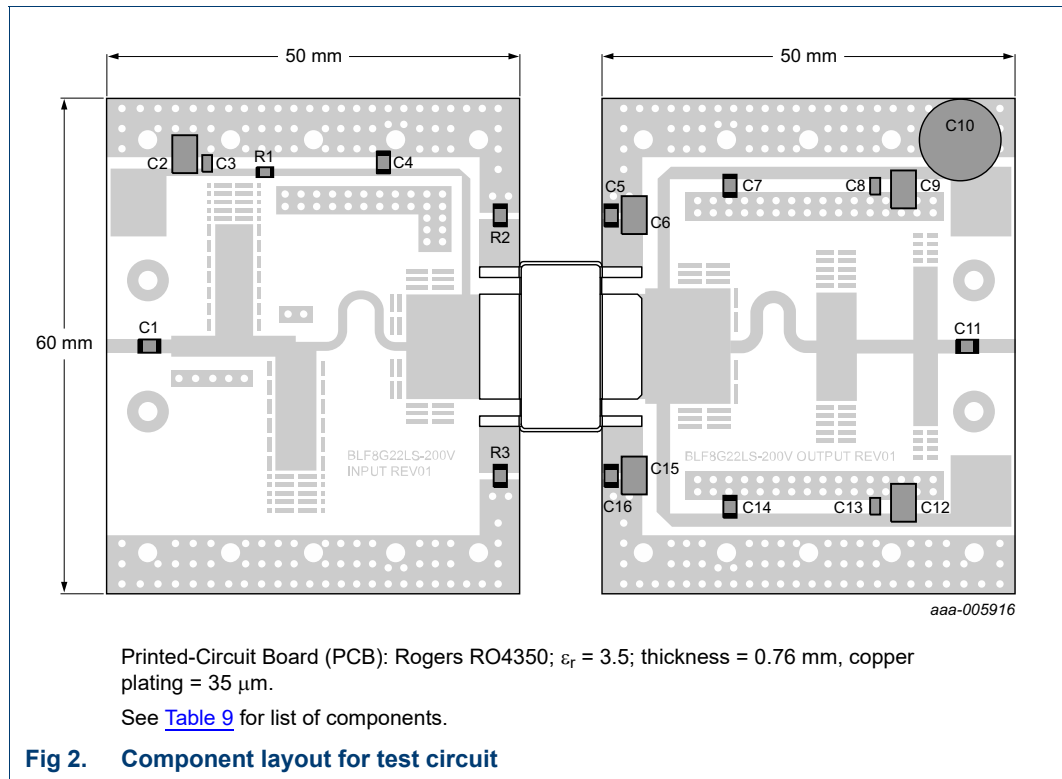

Fig 1. Definition of transistor impedance

7.3 Test circuit



**Table 9. List of components**

For test circuit, see [Figure 2](#).

Component	Description	Value	Remarks
C1, C4, C7, C11, C14	multilayer ceramic chip capacitor	8.2 pF	ATC100B; vertically mounted
C2	multilayer ceramic chip capacitor	1 $\mu\text{F}$	Murata
C3, C5, C16	multilayer ceramic chip capacitor	100 nF	Murata
C8, C13	multilayer ceramic chip capacitor	220 nF, 50 V	Murata
C6, C9, C12, C15	multilayer ceramic chip capacitor	4.7 $\mu\text{F}$ , 50 V	Murata
C10	electrolytic capacitor	>470 $\mu\text{F}$ , 50 V	low ESR
R1	resistor	2.2 $\Omega$	SMD 0805; tolerance = 1 %
R2, R3	resistor	0 $\Omega$	SMD 0805

7.4 Graphs

7.4.1 Pulsed CW

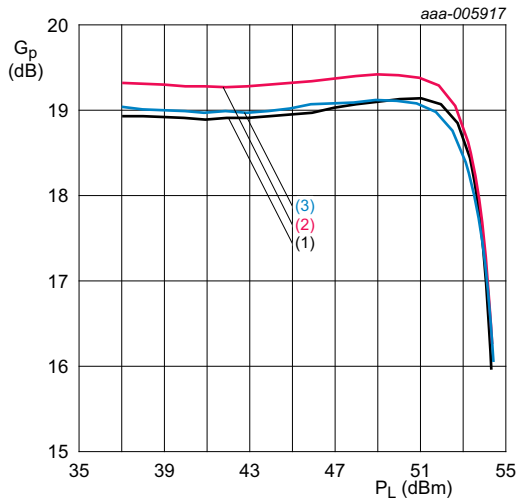

$V_{DS} = 28\text{ V}; I_{Dq} = 2000\text{ mA}; t_p = 100\text{ }\mu\text{s}; \delta = 10\text{ \%}$ .

- (1)  $f = 2110\text{ MHz}$
- (2)  $f = 2140\text{ MHz}$
- (3)  $f = 2170\text{ MHz}$

**Fig 3. Power gain as a function of output power; typical values**

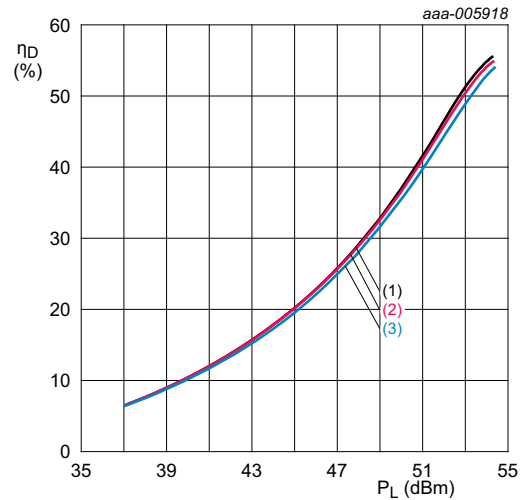

$V_{DS} = 28\text{ V}; I_{Dq} = 2000\text{ mA}; t_p = 100\text{ }\mu\text{s}; \delta = 10\text{ \%}$ .

- (1)  $f = 2110\text{ MHz}$
- (2)  $f = 2140\text{ MHz}$
- (3)  $f = 2170\text{ MHz}$

**Fig 4. Drain efficiency as a function of output power; typical values**

7.4.2 IS-95

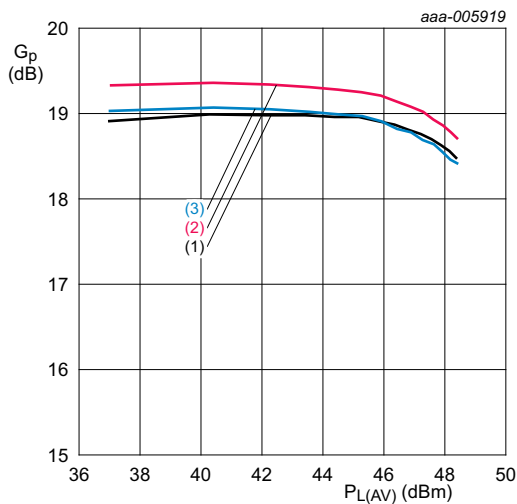

$V_{DS} = 28\text{ V}; I_{Dq} = 2000\text{ mA}.$   
 (1)  $f = 2110\text{ MHz}$   
 (2)  $f = 2140\text{ MHz}$   
 (3)  $f = 2170\text{ MHz}$

**Fig 5. Power gain as a function of average output power; typical values**

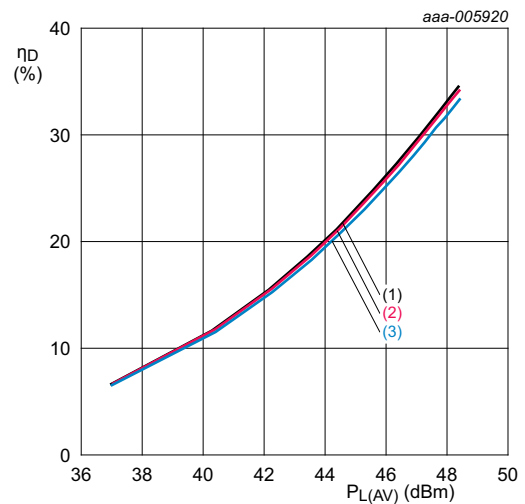

$V_{DS} = 28\text{ V}; I_{Dq} = 2000\text{ mA}.$   
 (1)  $f = 2110\text{ MHz}$   
 (2)  $f = 2140\text{ MHz}$   
 (3)  $f = 2170\text{ MHz}$

**Fig 6. Drain efficiency as a function of average output power; typical values**

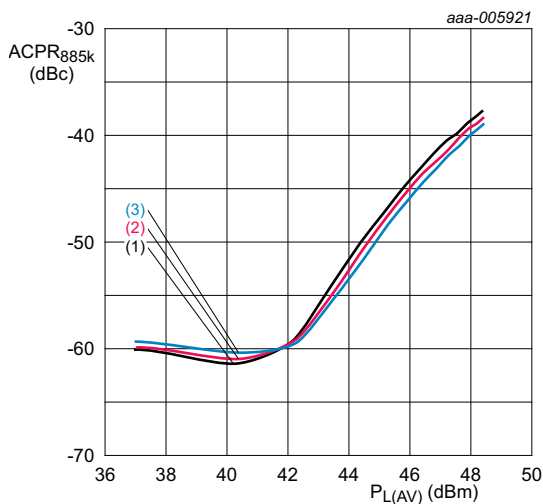

$V_{DS} = 28\text{ V}; I_{Dq} = 2000\text{ mA}.$   
 (1)  $f = 2110\text{ MHz}$   
 (2)  $f = 2140\text{ MHz}$   
 (3)  $f = 2170\text{ MHz}$

**Fig 7. Adjacent channel power ratio (885 kHz) as a function of average output power; typical values**

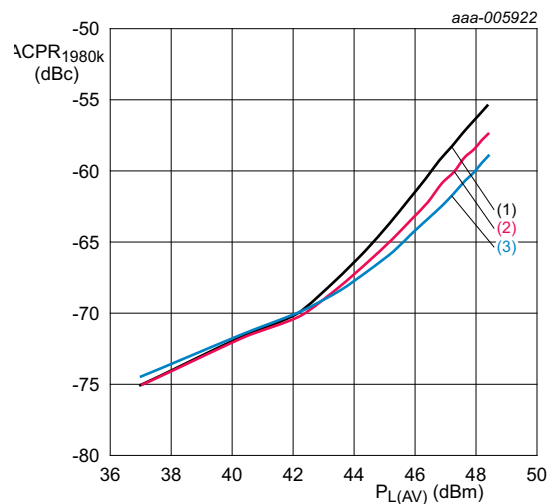

$V_{DS} = 28\text{ V}; I_{Dq} = 2000\text{ mA}.$   
 (1)  $f = 2110\text{ MHz}$   
 (2)  $f = 2140\text{ MHz}$   
 (3)  $f = 2170\text{ MHz}$

**Fig 8. Adjacent channel power ratio (1980 kHz) as a function of average output power; typical values**

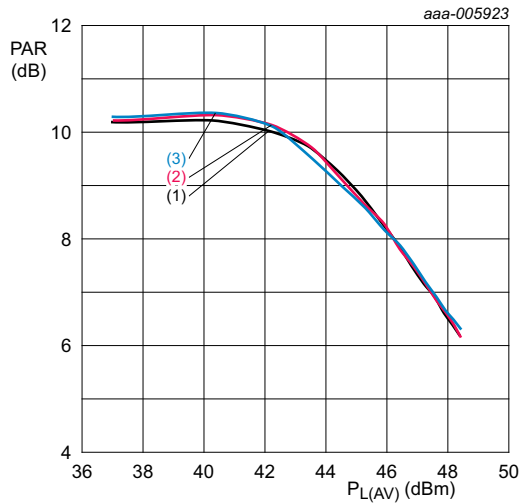

$V_{DS} = 28\text{ V}; I_{Dq} = 2000\text{ mA}.$   
 (1)  $f = 2110\text{ MHz}$   
 (2)  $f = 2140\text{ MHz}$   
 (3)  $f = 2170\text{ MHz}$

**Fig 9. Peak-to-average power ratio as a function of average output power; typical values**

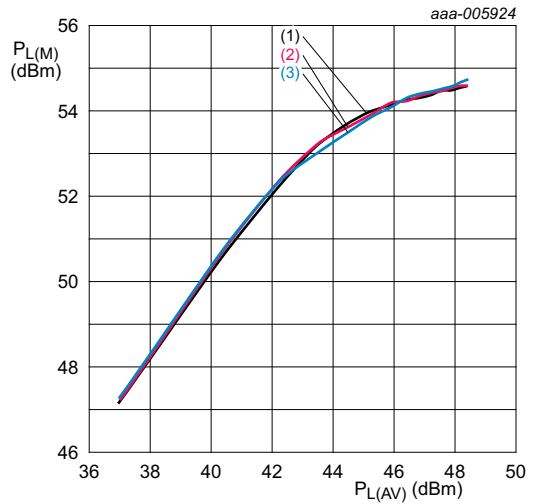

$V_{DS} = 28\text{ V}; I_{Dq} = 2000\text{ mA}.$   
 (1)  $f = 2110\text{ MHz}$   
 (2)  $f = 2140\text{ MHz}$   
 (3)  $f = 2170\text{ MHz}$

**Fig 10. Peak output power as a function of average output power; typical values**

7.4.3 1-Carrier W-CDMA

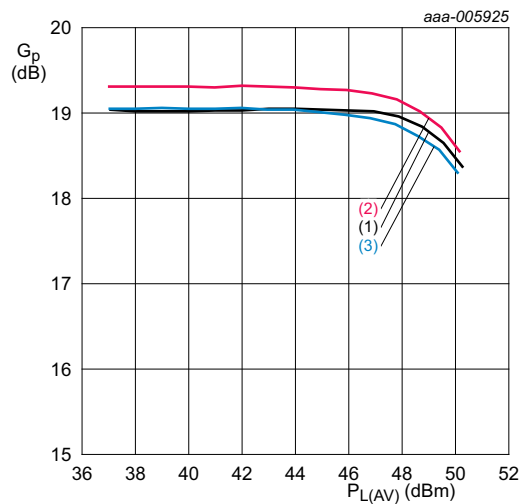

$V_{DS} = 28\text{ V}; I_{Dq} = 2000\text{ mA}.$   
 (1)  $f = 2112.5\text{ MHz}$   
 (2)  $f = 2140\text{ MHz}$   
 (3)  $f = 2167.5\text{ MHz}$

**Fig 11. Power gain as a function of average output power; typical values**

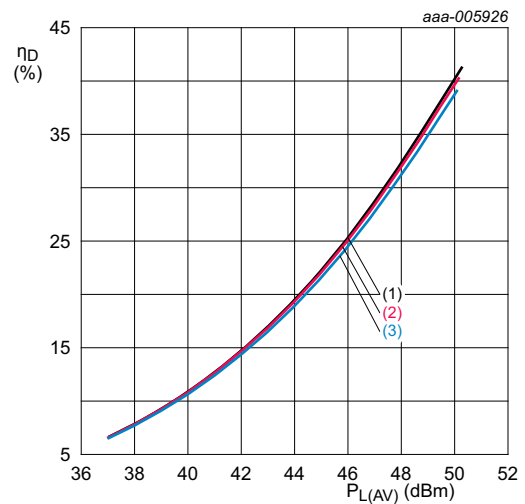

$V_{DS} = 28\text{ V}; I_{Dq} = 2000\text{ mA}.$   
 (1)  $f = 2112.5\text{ MHz}$   
 (2)  $f = 2140\text{ MHz}$   
 (3)  $f = 2167.5\text{ MHz}$

**Fig 12. Drain efficiency as a function of average output power; typical values**



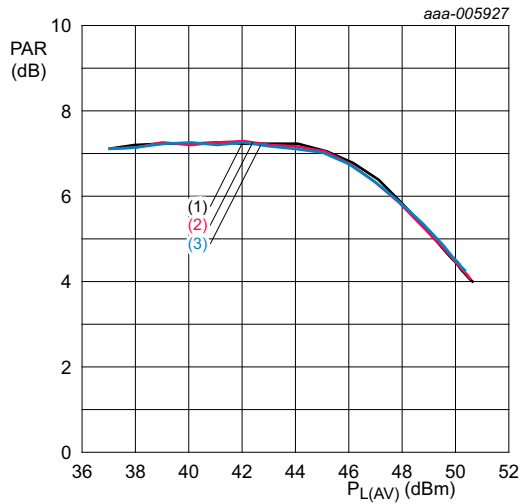

$V_{DS} = 28\text{ V}; I_{Dq} = 2000\text{ mA}$ .  
 (1)  $f = 2112.5\text{ MHz}$   
 (2)  $f = 2140\text{ MHz}$   
 (3)  $f = 2167.5\text{ MHz}$

**Fig 13. Peak-to-average power ratio as a function of average output power; typical values**

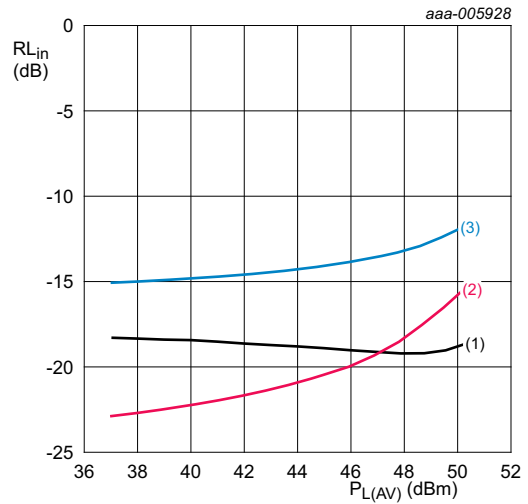

$V_{DS} = 28\text{ V}; I_{Dq} = 2000\text{ mA}$ .  
 (1)  $f = 2112.5\text{ MHz}$   
 (2)  $f = 2140\text{ MHz}$   
 (3)  $f = 2167.5\text{ MHz}$

**Fig 14. Input return loss as a function of average output power; typical values**

7.4.4 2-Carrier W-CDMA

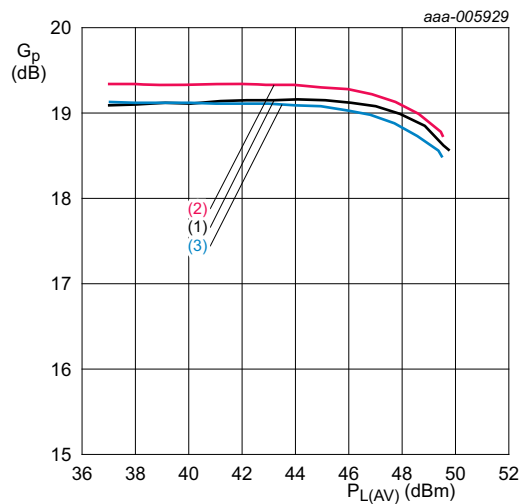

$V_{DS} = 28\text{ V}; I_{Dq} = 2000\text{ mA}; 5\text{ MHz carrier spacing}$ .  
 (1)  $f = 2115\text{ MHz}$   
 (2)  $f = 2140\text{ MHz}$   
 (3)  $f = 2165\text{ MHz}$

**Fig 15. Power gain as a function of average output power; typical values**

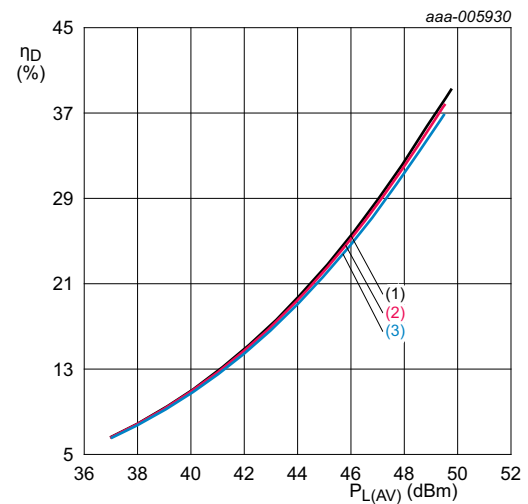

$V_{DS} = 28\text{ V}; I_{Dq} = 2000\text{ mA}; 5\text{ MHz carrier spacing}$ .  
 (1)  $f = 2115\text{ MHz}$   
 (2)  $f = 2140\text{ MHz}$   
 (3)  $f = 2165\text{ MHz}$

**Fig 16. Drain efficiency as a function of average output power; typical values**

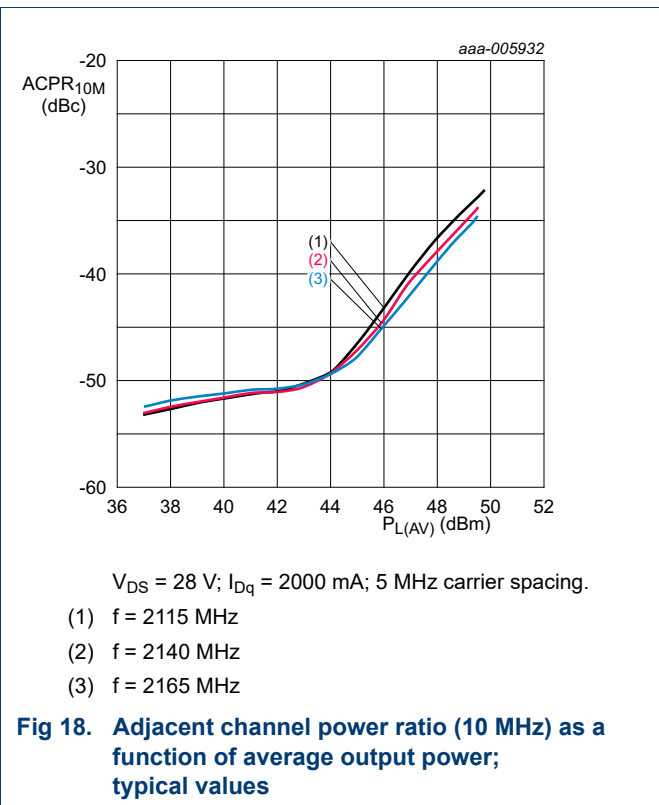
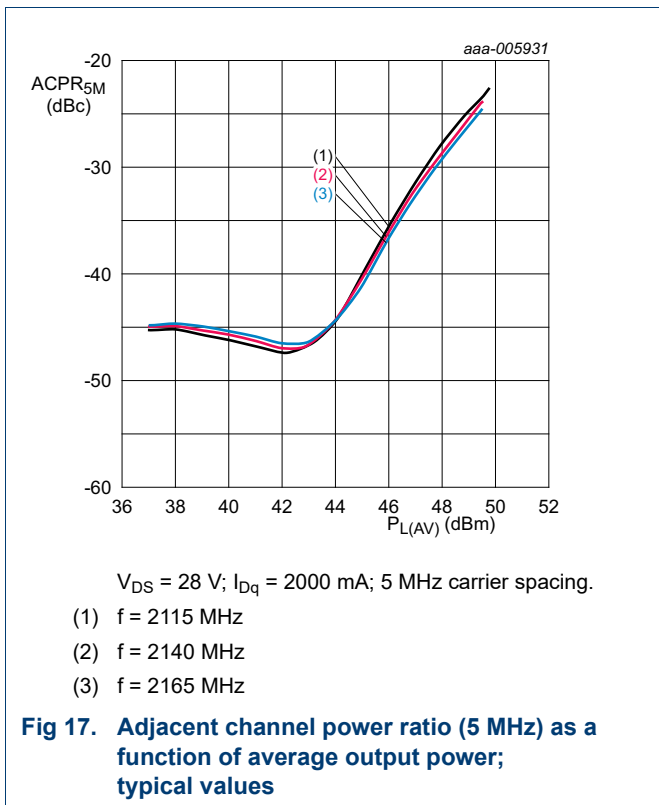

7.4.5 2-Tone VBW

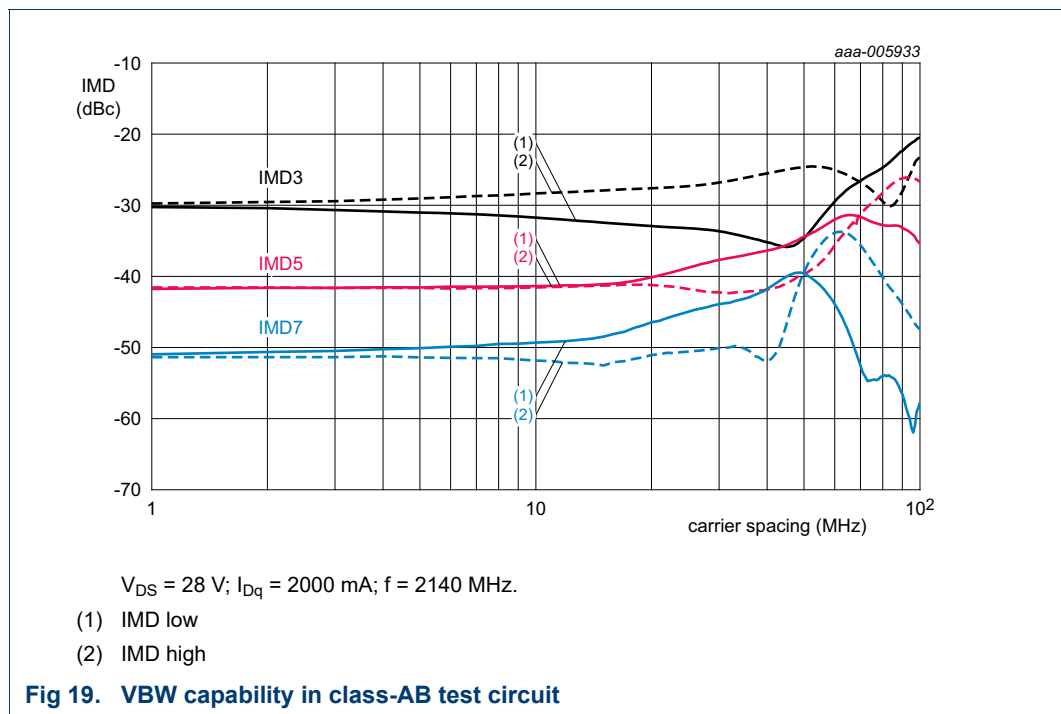

### 8. Package outline

Earless flanged ceramic package; 6 leads

SOT1244B

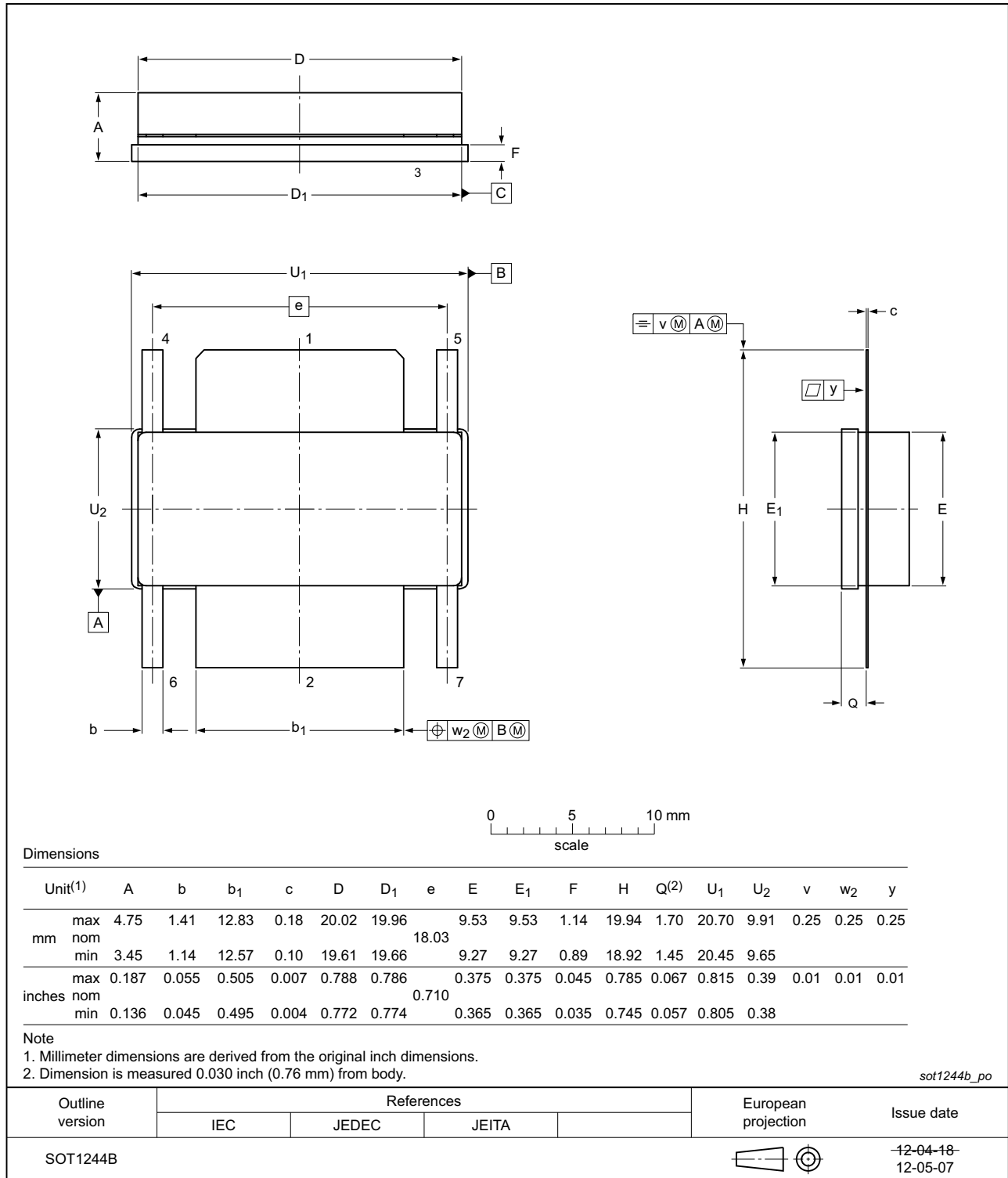

Fig 20. Package outline SOT1244B

Earless flanged ceramic package; 6 leads

SOT1244C

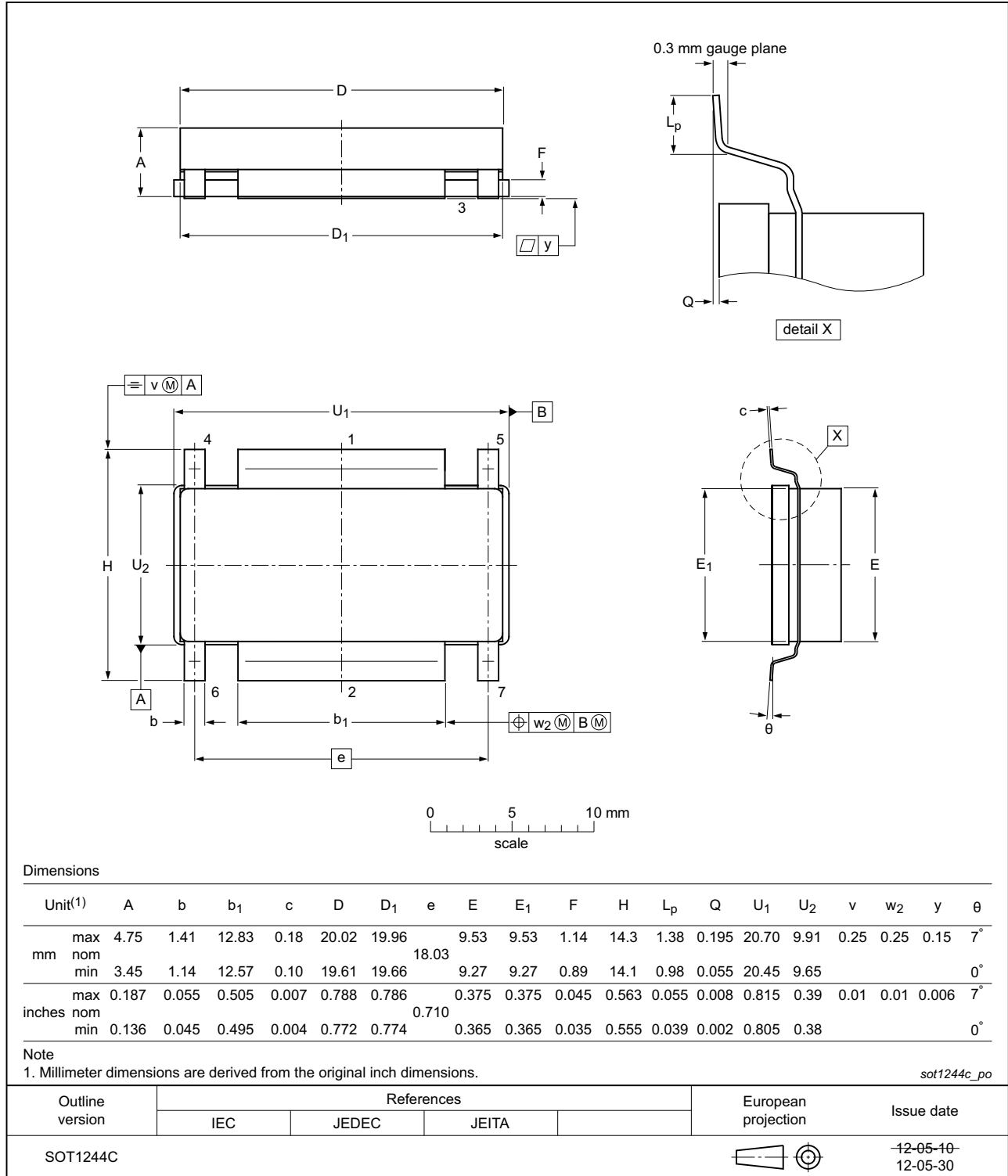

Fig 21. Package outline SOT1244C

## 9. Handling information

### CAUTION



This device is sensitive to ElectroStatic Discharge (ESD). Observe precautions for handling electrostatic sensitive devices.

Such precautions are described in the *ANSI/ESD S20.20*, *IEC/ST 61340-5*, *JESD625-A* or equivalent standards.

## 10. Abbreviations

Table 10. Abbreviations

Acronym	Description
3GPP	3rd Generation Partnership Project
CCDF	Complementary Cumulative Distribution Function
CW	Continuous Wave
DPCH	Dedicated Physical Channel
ESD	ElectroStatic Discharge
ESR	Equivalent Series Resistance
IMD	InterModulation Distortion
IS-95	Interim Standard 95
LDMOS	Laterally Diffused Metal Oxide Semiconductor
PAR	Peak-to-Average Ratio
SMD	Surface Mounted Device
VBW	Video BandWidth
VSWR	Voltage Standing Wave Ratio
W-CDMA	Wideband Code Division Multiple Access

## 11. Revision history

Table 11. Revision history

Document ID	Release date	Data sheet status	Change notice	Supersedes
BLF8G22LS-200V_8G22LS-200GV#3	20150901	Product data sheet		BLF8G22LS-200V_8G22LS-200GV v.2
Modifications:	<ul style="list-style-type: none"> <li>The format of this document has been redesigned to comply with the new identity guidelines of Ampleon.</li> <li>Legal texts have been adapted to the new company name where appropriate.</li> </ul>			
BLF8G22LS-200V_8G22LS-200GV v.2	20121210	Product data sheet	-	BLF8G22LS-200V_8G22LS-200GV v.1
BLF8G22LS-200V_8G22LS-200GV v.1	20120613	Objective data sheet	-	-

## 12. Legal information

### 12.1 Data sheet status

Document status <sup>[1][2]</sup>	Product status <sup>[3]</sup>	Definition
Objective [short] data sheet	Development	This document contains data from the objective specification for product development.
Preliminary [short] data sheet	Qualification	This document contains data from the preliminary specification.
Product [short] data sheet	Production	This document contains the product specification.

[1] Please consult the most recently issued document before initiating or completing a design.

[2] The term 'short data sheet' is explained in section "Definitions".

[3] The product status of device(s) described in this document may have changed since this document was published and may differ in case of multiple devices. The latest product status information is available on the Internet at URL <http://www.ampleon.com>.

### 12.2 Definitions

**Draft** — The document is a draft version only. The content is still under internal review and subject to formal approval, which may result in modifications or additions. Ampleon does not give any representations or warranties as to the accuracy or completeness of information included herein and shall have no liability for the consequences of use of such information.

**Short data sheet** — A short data sheet is an extract from a full data sheet with the same product type number(s) and title. A short data sheet is intended for quick reference only and should not be relied upon to contain detailed and full information. For detailed and full information see the relevant full data sheet, which is available on request via the local Ampleon sales office. In case of any inconsistency or conflict with the short data sheet, the full data sheet shall prevail.

**Product specification** — The information and data provided in a Product data sheet shall define the specification of the product as agreed between Ampleon and its customer, unless Ampleon and customer have explicitly agreed otherwise in writing. In no event however, shall an agreement be valid in which the Ampleon product is deemed to offer functions and qualities beyond those described in the Product data sheet.

Ampleon product can reasonably be expected to result in personal injury, death or severe property or environmental damage. Ampleon and its suppliers accept no liability for inclusion and/or use of Ampleon products in such equipment or applications and therefore such inclusion and/or use is at the customer's own risk.

**Applications** — Applications that are described herein for any of these products are for illustrative purposes only. Ampleon makes no representation or warranty that such applications will be suitable for the specified use without further testing or modification.

Customers are responsible for the design and operation of their applications and products using Ampleon products, and Ampleon accepts no liability for any assistance with applications or customer product design. It is customer's sole responsibility to determine whether the Ampleon product is suitable and fit for the customer's applications and products planned, as well as for the planned application and use of customer's third party customer(s). Customers should provide appropriate design and operating safeguards to minimize the risks associated with their applications and products.

Ampleon does not accept any liability related to any default, damage, costs or problem which is based on any weakness or default in the customer's applications or products, or the application or use by customer's third party customer(s). Customer is responsible for doing all necessary testing for the customer's applications and products using Ampleon products in order to avoid a default of the applications and the products or of the application or use by customer's third party customer(s). Ampleon does not accept any liability in this respect.

**Limiting values** — Stress above one or more limiting values (as defined in the Absolute Maximum Ratings System of IEC 60134) will cause permanent damage to the device. Limiting values are stress ratings only and (proper) operation of the device at these or any other conditions above those given in the Recommended operating conditions section (if present) or the Characteristics sections of this document is not warranted. Constant or repeated exposure to limiting values will permanently and irreversibly affect the quality and reliability of the device.

**Terms and conditions of commercial sale** — Ampleon products are sold subject to the general terms and conditions of commercial sale, as published at <http://www.ampleon.com/terms>, unless otherwise agreed in a valid written individual agreement. In case an individual agreement is concluded only the terms and conditions of the respective agreement shall apply. Ampleon hereby expressly objects to applying the customer's general terms and conditions with regard to the purchase of Ampleon products by customer.

**No offer to sell or license** — Nothing in this document may be interpreted or construed as an offer to sell products that is open for acceptance or the grant, conveyance or implication of any license under any copyrights, patents or other industrial or intellectual property rights.

**Export control** — This document as well as the item(s) described herein may be subject to export control regulations. Export might require a prior authorization from competent authorities.

### 12.3 Disclaimers

**Limited warranty and liability** — Information in this document is believed to be accurate and reliable. However, Ampleon does not give any representations or warranties, expressed or implied, as to the accuracy or completeness of such information and shall have no liability for the consequences of use of such information. Ampleon takes no responsibility for the content in this document if provided by an information source outside of Ampleon.

In no event shall Ampleon be liable for any indirect, incidental, punitive, special or consequential damages (including - without limitation - lost profits, lost savings, business interruption, costs related to the removal or replacement of any products or rework charges) whether or not such damages are based on tort (including negligence), warranty, breach of contract or any other legal theory.

Notwithstanding any damages that customer might incur for any reason whatsoever, Ampleon' aggregate and cumulative liability towards customer for the products described herein shall be limited in accordance with the *Terms and conditions of commercial sale* of Ampleon.

**Right to make changes** — Ampleon reserves the right to make changes to information published in this document, including without limitation specifications and product descriptions, at any time and without notice. This document supersedes and replaces all information supplied prior to the publication hereof.

**Suitability for use** — Ampleon products are not designed, authorized or warranted to be suitable for use in life support, life-critical or safety-critical systems or equipment, nor in applications where failure or malfunction of an

**Non-automotive qualified products** — Unless this data sheet expressly states that this specific Ampleon product is automotive qualified, the product is not suitable for automotive use. It is neither qualified nor tested in accordance with automotive testing or application requirements. Ampleon accepts no liability for inclusion and/or use of non-automotive qualified products in automotive equipment or applications.

In the event that customer uses the product for design-in and use in automotive applications to automotive specifications and standards, customer (a) shall use the product without Ampleon' warranty of the product for such automotive applications, use and specifications, and (b) whenever customer uses the product for automotive applications beyond Ampleon' specifications such use shall be solely at customer's own risk, and (c) customer fully indemnifies Ampleon for any liability, damages or failed product claims resulting from customer design and use of the product for automotive applications beyond Ampleon' standard warranty and Ampleon' product specifications.

**Translations** — A non-English (translated) version of a document is for reference only. The English version shall prevail in case of any discrepancy between the translated and English versions.

## 13. Contact information

---

For more information, please visit:  
<http://www.ampleon.com>

## 12.4 Trademarks

Notice: All referenced brands, product names, service names and trademarks are the property of their respective owners.

Any reference or use of any 'NXP' trademark in this document or in or on the surface of Ampleon products does not result in any claim, liability or entitlement vis-à-vis the owner of this trademark. Ampleon is no longer part of the NXP group of companies and any reference to or use of the 'NXP' trademarks will be replaced by reference to or use of Ampleon's own Any reference or use of any 'NXP' trademark in this document or in or on the surface of Ampleon products does not result in any claim, liability or entitlement vis-à-vis the owner of this trademark. Ampleon is no longer part of the NXP group of companies and any reference to or use of the 'NXP' trademarks will be replaced by reference to or use of Ampleon's own trademarks.

For sales office addresses, please visit:  
<http://www.ampleon.com/sales>

14. Contents

1 **Product profile** . . . . . 1

1.1 General description . . . . . 1

1.2 Features and benefits . . . . . 1

1.3 Applications . . . . . 1

2 **Pinning information** . . . . . 2

3 **Ordering information** . . . . . 2

4 **Limiting values** . . . . . 2

5 **Thermal characteristics** . . . . . 3

6 **Characteristics** . . . . . 3

7 **Test information** . . . . . 3

7.1 Ruggedness in class-AB operation . . . . . 3

7.2 Impedance information . . . . . 4

7.3 Test circuit . . . . . 5

7.4 Graphs . . . . . 6

7.4.1 Pulsed CW . . . . . 6

7.4.2 IS-95 . . . . . 7

7.4.3 1-Carrier W-CDMA . . . . . 8

7.4.4 2-Carrier W-CDMA . . . . . 9

7.4.5 2-Tone VBW . . . . . 10

8 **Package outline** . . . . . 11

9 **Handling information** . . . . . 13

10 **Abbreviations** . . . . . 13

11 **Revision history** . . . . . 13

12 **Legal information** . . . . . 14

12.1 Data sheet status . . . . . 14

12.2 Definitions . . . . . 14

12.3 Disclaimers . . . . . 14

12.4 Trademarks . . . . . 15

13 **Contact information** . . . . . 15

14 **Contents** . . . . . 16

Please be aware that important notices concerning this document and the product(s) described herein, have been included in section 'Legal information'.

© Ampleon The Netherlands B.V. 2015. All rights reserved.

For more information, please visit: <http://www.ampleon.com>  
 For sales office addresses, please visit: <http://www.ampleon.com/sales>

Date of release: 1 September 2015

Document identifier: BLF8G22LS-200V\_8G22LS-200GV#3