

IRG4BC20SDPbF

INSULATED GATE BIPOLAR TRANSISTOR WITH ULTRAFAST SOFT RECOVERY DIODE Standard Speed IGBT

Features

- Extremely low voltage drop 1.4Vtyp. @ 10A
- S-Series: Minimizes power dissipation at up to 3 KHz PWM frequency in inverter drives, up to 4 KHz in brushless DC drives.
- Very Tight Vce(on) distribution
- IGBT co-packaged with HEXFRED™ ultrafast, ultra-soft-recovery anti-parallel diodes for use in bridge configurations
- Industry standard TO-220AB package
- Lead-Free

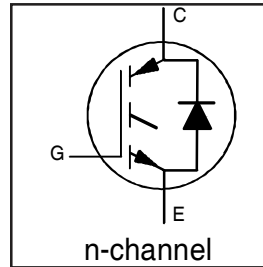

$V_{CES} = 600V$
$V_{CE(on) typ.} = 1.4V$
@ $V_{GE} = 15V, I_C = 10A$

Benefits

- Generation 4 IGBT's offer highest efficiencies available
- IGBT's optimized for specific application conditions
- HEXFRED diodes optimized for performance with IGBT's. Minimized recovery characteristics require less/no snubbing
- Lower losses than MOSFET's conduction and Diode losses

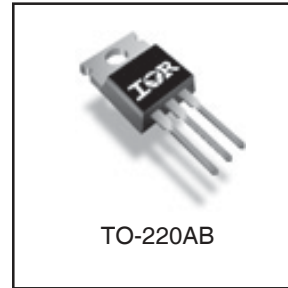

Absolute Maximum Ratings

	Parameter	Max.	Units
V_{CES}	Collector-to-Emitter Voltage	600	V
$I_C @ T_C = 25^\circ C$	Continuous Collector Current	19	A
$I_C @ T_C = 100^\circ C$	Continuous Collector Current	10	
I_{CM}	Pulsed Collector Current ①	38	
I_{LM}	Clamped Inductive Load Current ②	38	
$I_F @ T_C = 100^\circ C$	Diode Continuous Forward Current	7.0	
I_{FM}	Diode Maximum Forward Current	38	
V_{GE}	Gate-to-Emitter Voltage	± 20	V
$P_D @ T_C = 25^\circ C$	Maximum Power Dissipation	60	W
$P_D @ T_C = 100^\circ C$	Maximum Power Dissipation	24	
T_J	Operating Junction and	-55 to +150	°C
T_{STG}	Storage Temperature Range		
	Soldering Temperature, for 10 sec.	300 (0.063 in. (1.6mm) from case)	
	Mounting Torque, 6-32 or M3 Screw.	10 lbf•in (1.1 N•m)	

Thermal Resistance

	Parameter	Min.	Typ.	Max.	Units
$R_{\theta JC}$	Junction-to-Case - IGBT	—	—	2.1	°C/W
$R_{\theta JC}$	Junction-to-Case - Diode	—	—	3.5	
$R_{\theta CS}$	Case-to-Sink, flat, greased surface	—	0.50	—	
$R_{\theta JA}$	Junction-to-Ambient, typical socket mount	—	—	80	
Wt	Weight	—	2 (0.07)	—	g (oz)

IRG4BC20SDPbF

Electrical Characteristics @ T_J = 25°C (unless otherwise specified)

	Parameter	Min.	Typ.	Max.	Units	Conditions
V _{(BR)CES}	Collector-to-Emitter Breakdown Voltage _f	600	—	—	V	V _{GE} = 0V, I _C = 250μA
ΔV _{(BR)CES} /ΔT _J	Temperature Coeff. of Breakdown Voltage	—	0.75	—	V/°C	V _{GE} = 0V, I _C = 1.0mA
V _{CE(on)}	Collector-to-Emitter Saturation Voltage	—	1.40	1.6	V	I _C = 10A I _C = 19A I _C = 10A, T _J = 150°C
		—	1.85	—		
		—	1.44	—		
V _{GE(th)}	Gate Threshold Voltage	3.0	—	6.0		V _{CE} = V _{GE} , I _C = 250μA
ΔV _{GE(th)} /ΔT _J	Temperature Coeff. of Threshold Voltage	—	-11	—	mV/°C	V _{CE} = V _{GE} , I _C = 250μA
g _{fe}	Forward Transconductance ④	2.0	5.8	—	S	V _{CE} = 100V, I _C = 10A
I _{CES}	Zero Gate Voltage Collector Current	—	—	250	μA	V _{GE} = 0V, V _{CE} = 600V V _{GE} = 0V, V _{CE} = 600V, T _J = 150°C
		—	—	1700		
V _{FM}	Diode Forward Voltage Drop	—	1.4	1.7	V	I _C = 8.0A I _C = 8.0A, T _J = 150°C
		—	1.3	1.6		
I _{GES}	Gate-to-Emitter Leakage Current	—	—	±100	nA	V _{GE} = ±20V

Switching Characteristics @ T_J = 25°C (unless otherwise specified)

	Parameter	Min.	Typ.	Max.	Units	Conditions
Q _g	Total Gate Charge (turn-on)	—	27	40	nC	I _C = 10A V _{CC} = 400V V _{GE} = 15V
Q _{ge}	Gate - Emitter Charge (turn-on)	—	4.3	6.5		
Q _{gc}	Gate - Collector Charge (turn-on)	—	10	15		
t _{d(on)}	Turn-On Delay Time	—	62	—	ns	T _J = 25°C I _C = 10A, V _{CC} = 480V V _{GE} = 15V, R _G = 50Ω Energy losses include "tail" and diode reverse recovery.
t _r	Rise Time	—	32	—		
t _{d(off)}	Turn-Off Delay Time	—	690	1040		
t _f	Fall Time	—	480	730	mJ	See Fig. 9, 10, 11, 18
E _{on}	Turn-On Switching Loss	—	0.32	—		
E _{off}	Turn-Off Switching Loss	—	2.58	—		
E _{ts}	Total Switching Loss	—	2.90	4.5	ns	T _J = 150°C, See Fig. 10, 11, 18 I _C = 10A, V _{CC} = 480V V _{GE} = 15V, R _G = 50Ω Energy losses include "tail" and diode reverse recovery.
t _{d(on)}	Turn-On Delay Time	—	64	—		
t _r	Rise Time	—	35	—		
t _{d(off)}	Turn-Off Delay Time	—	980	—	mJ	See Fig. 7
t _f	Fall Time	—	800	—		
E _{ts}	Total Switching Loss	—	4.33	—		
L _E	Internal Emitter Inductance	—	7.5	—	nH	Measured 5mm from package
C _{ies}	Input Capacitance	—	550	—	pF	V _{GE} = 0V V _{CC} = 30V f = 1.0MHz
C _{oes}	Output Capacitance	—	39	—		
C _{res}	Reverse Transfer Capacitance	—	7.1	—		
t _{rr}	Diode Reverse Recovery Time	—	37	55	ns	T _J = 25°C See Fig. 14 T _J = 125°C
		—	55	90		
I _{rr}	Diode Peak Reverse Recovery Current	—	3.5	5.0	A	T _J = 25°C See Fig. 15 T _J = 125°C
		—	4.5	8.0		
Q _{rr}	Diode Reverse Recovery Charge	—	65	138	nC	T _J = 25°C See Fig. 16 T _J = 125°C
		—	124	360		
di _{(rec)M} /dt	Diode Peak Rate of Fall of Recovery During t _b	—	240	—	A/μs	T _J = 25°C See Fig. 17 T _J = 125°C
		—	210	—		

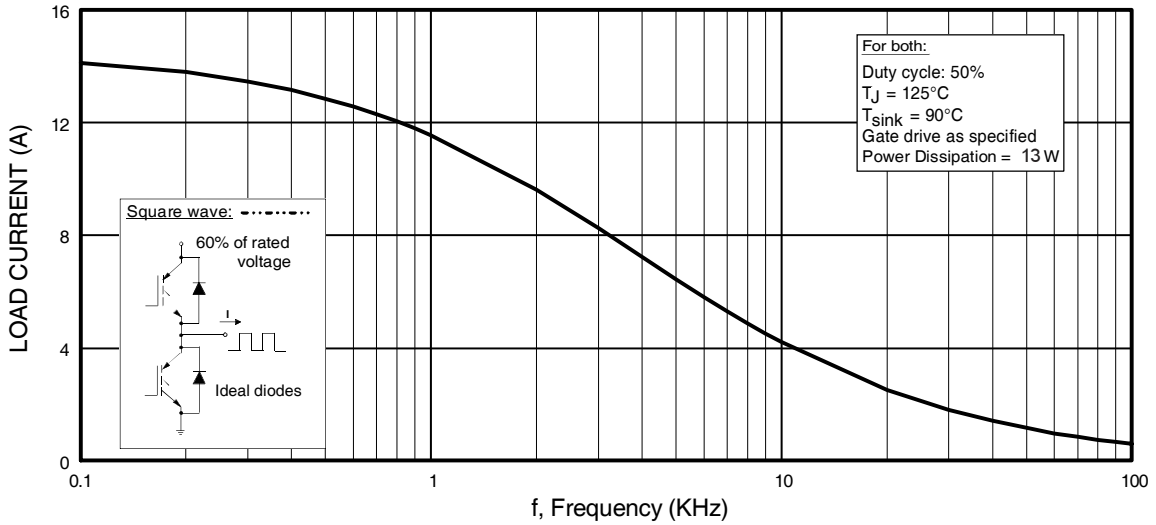

Fig. 1 - Typical Load Current vs. Frequency
 (Load Current = I_{RMS} of fundamental)

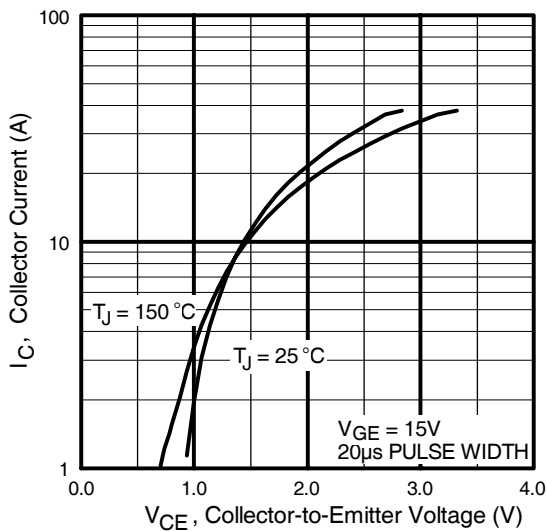

Fig. 2 - Typical Output Characteristics
www.irf.com

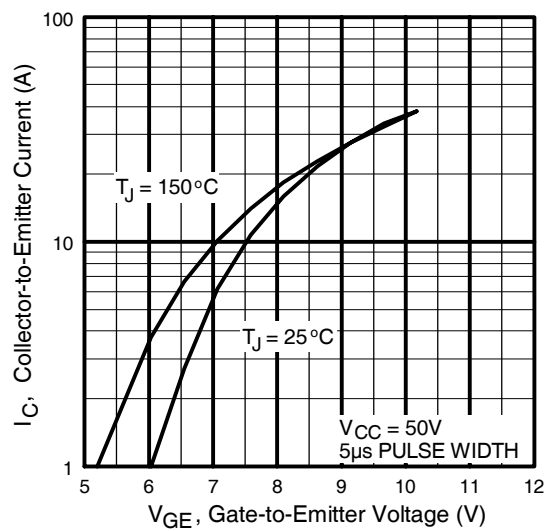

Fig. 3 - Typical Transfer Characteristics

IRG4BC20SDPbF

International
IRF Rectifier

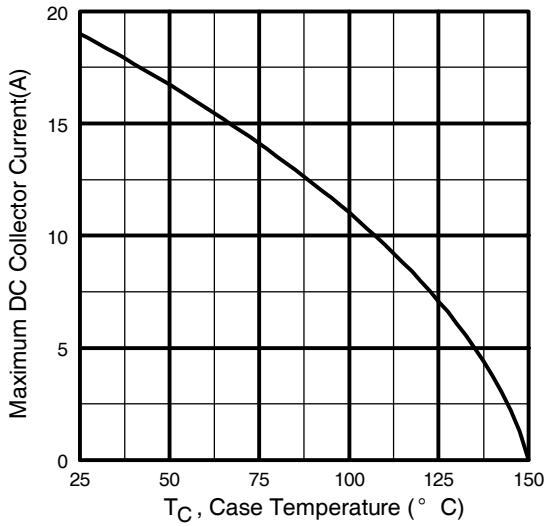

Fig. 4 - Maximum Collector Current vs. Case Temperature

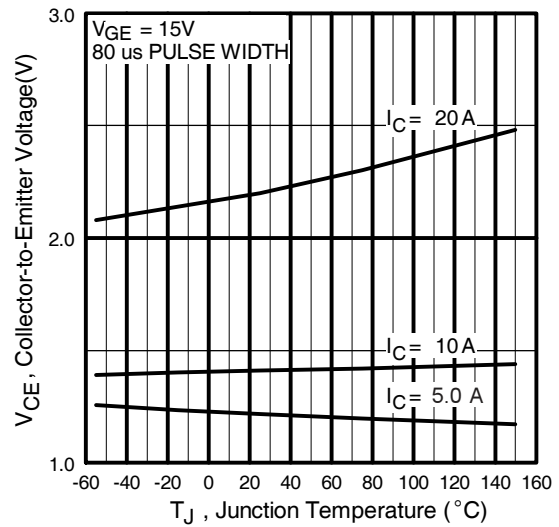

Fig. 5 - Typical Collector-to-Emitter Voltage vs. Junction Temperature

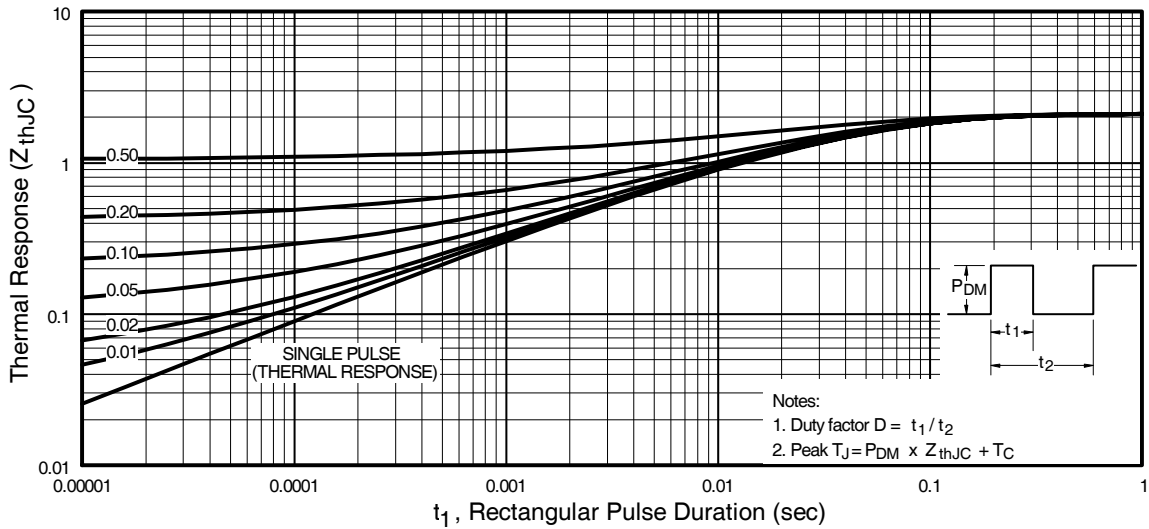

Fig. 6 - Maximum Effective Transient Thermal Impedance, Junction-to-Case

IRG4BC20SDPbF

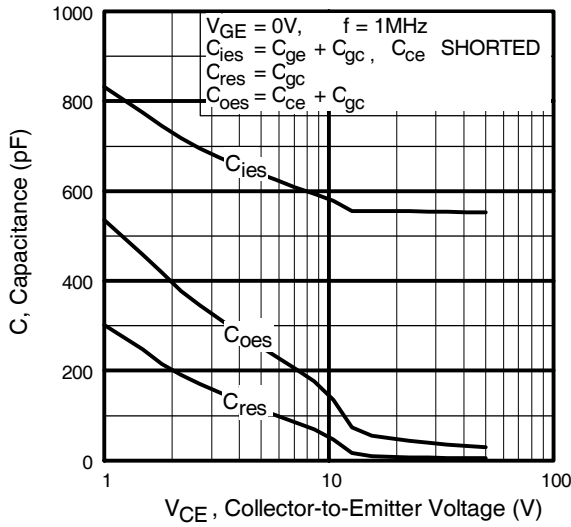

Fig. 7 - Typical Capacitance vs. Collector-to-Emitter Voltage

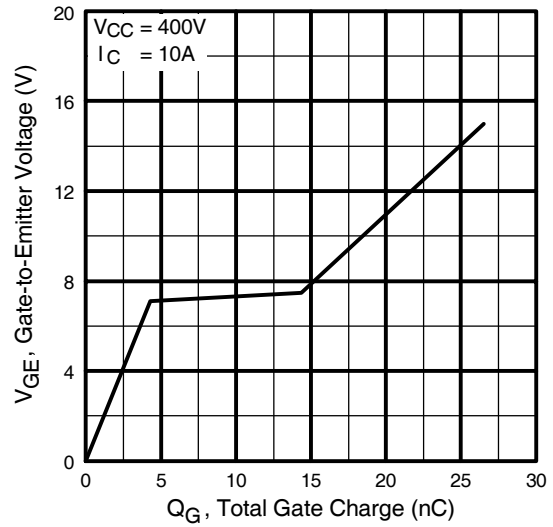

Fig. 8 - Typical Gate Charge vs. Gate-to-Emitter Voltage

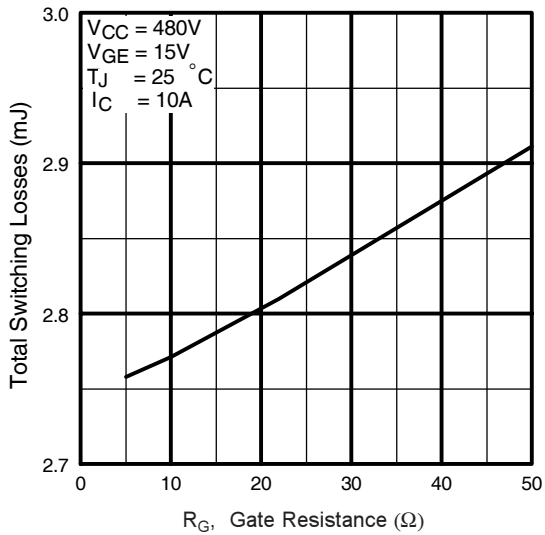

Fig. 9 - Typical Switching Losses vs. Gate Resistance

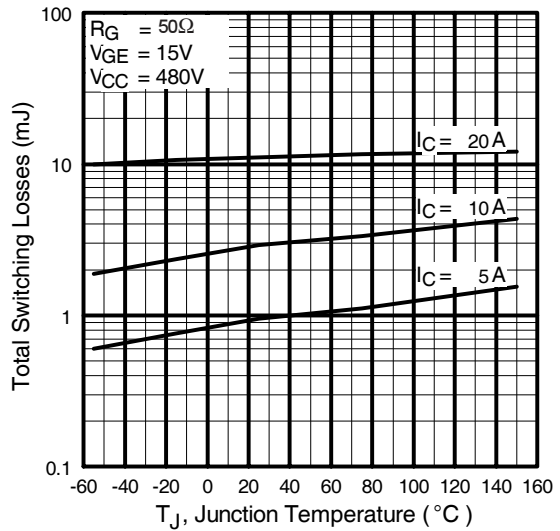

Fig. 10 - Typical Switching Losses vs. Junction Temperature

IRG4BC20SDPbF

International
IR Rectifier

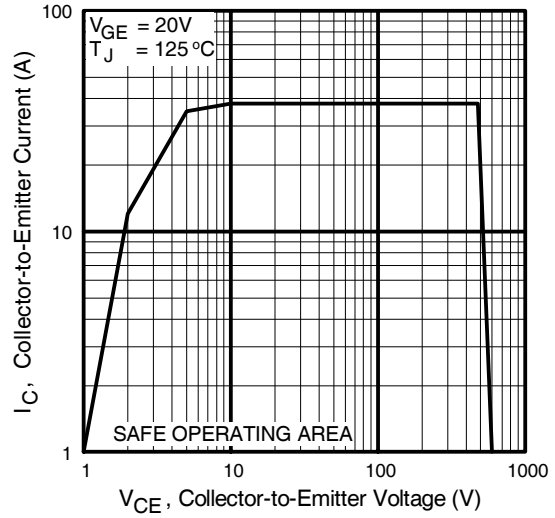
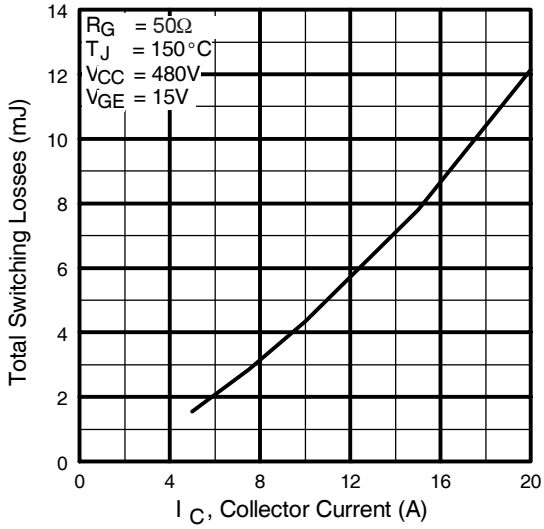

Fig. 11 - Typical Switching Losses vs. Collector-to-Emitter Current

Fig. 12 - Turn-Off SOA

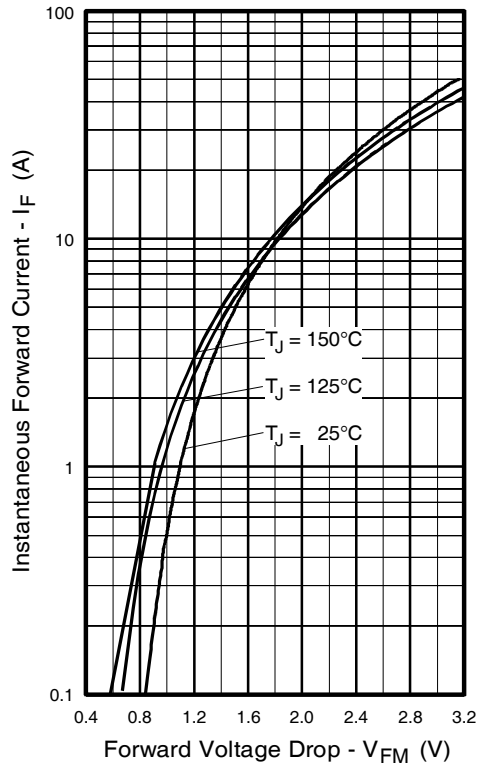

Fig. 13 - Maximum Forward Voltage Drop vs. Instantaneous Forward Current

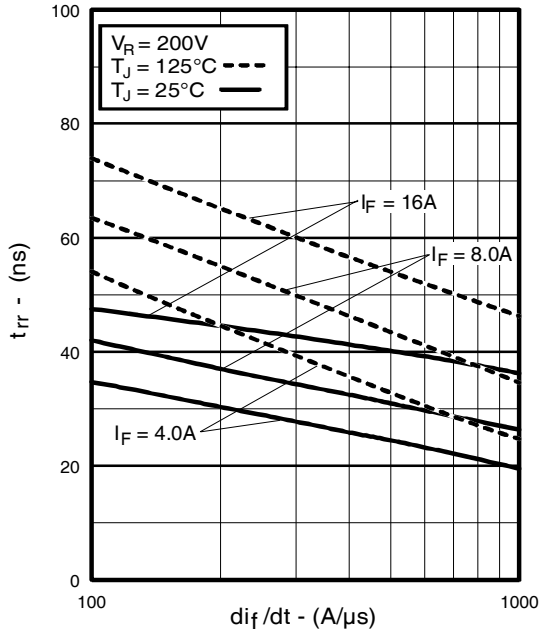

Fig. 14 - Typical Reverse Recovery vs. di_f/dt

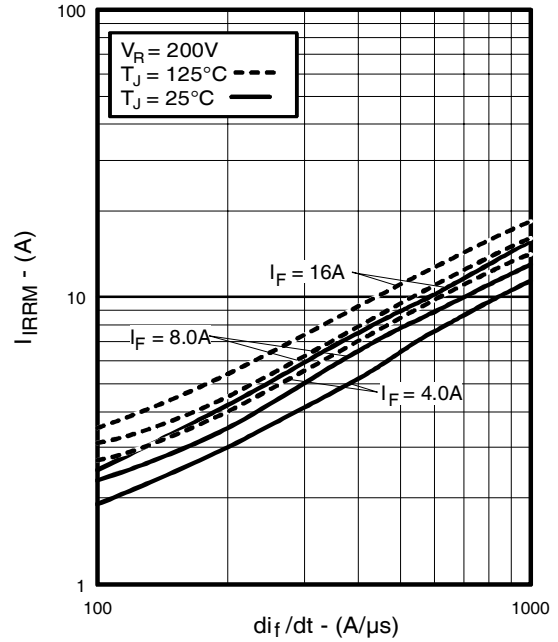

Fig. 15 - Typical Recovery Current vs. di_f/dt

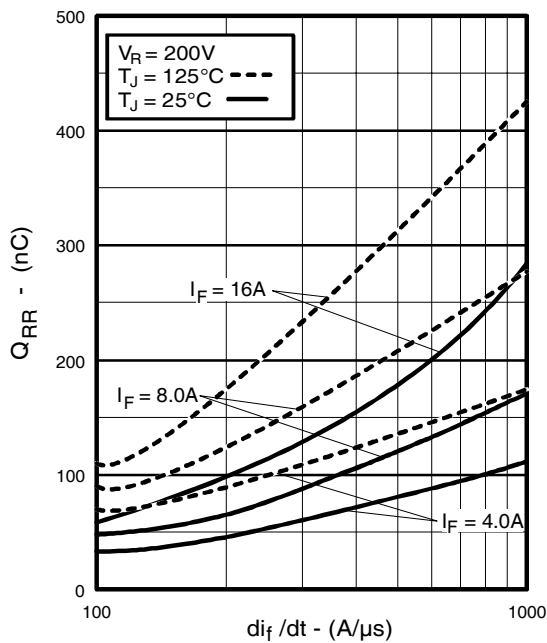

Fig. 16 - Typical Stored Charge vs. di_f/dt
www.irf.com

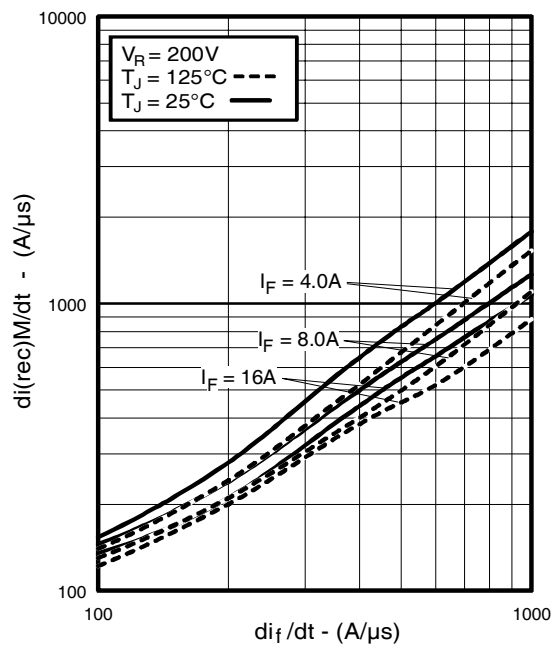

Fig. 17 - Typical $di_{(rec)M}/dt$ vs. di_f/dt

IRG4BC20SDPbF

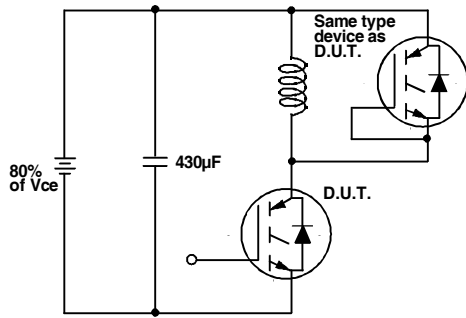

Fig. 18a - Test Circuit for Measurement of I_{LM} , E_{on} , $E_{off}(\text{diode})$, t_{rr} , Q_{rr} , I_{rr} , $t_{d(on)}$, t_r , $t_{d(off)}$, t_f

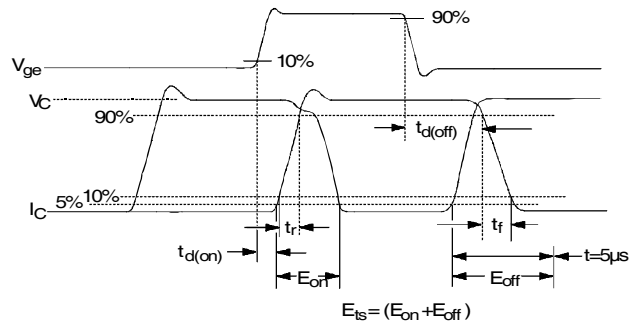

Fig. 18b - Test Waveforms for Circuit of Fig. 18a, Defining E_{off} , $t_{d(off)}$, t_f

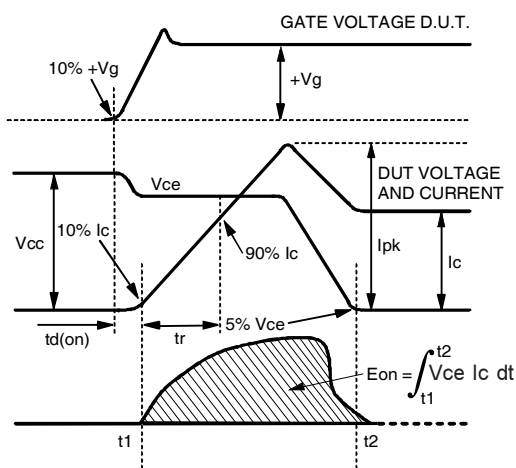

Fig. 18c - Test Waveforms for Circuit of Fig. 18a, Defining E_{on} , $t_{d(on)}$, t_r

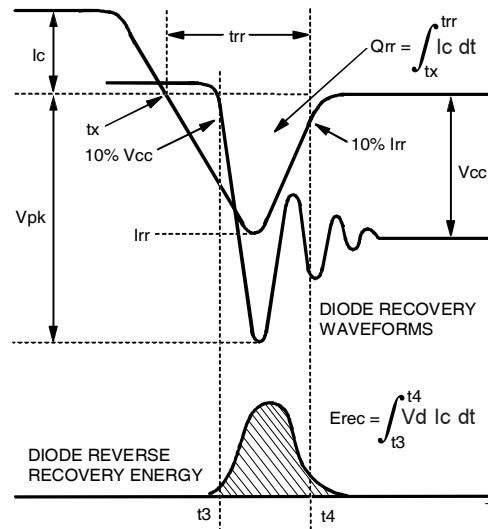

Fig. 18d - Test Waveforms for Circuit of Fig. 18a, Defining E_{rec} , t_{rr} , Q_{rr} , I_{rr}

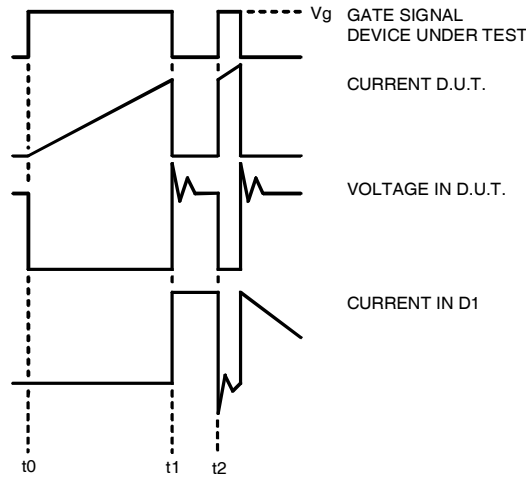

Figure 18e. Macro Waveforms for Figure 18a's Test Circuit

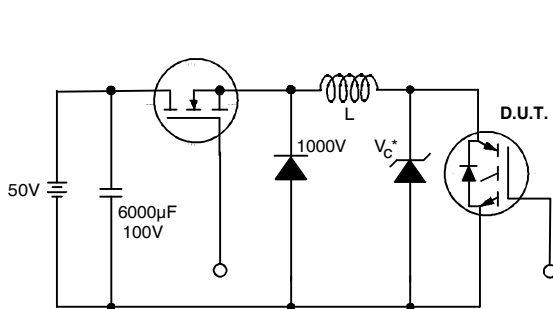

Figure 19. Clamped Inductive Load Test Circuit

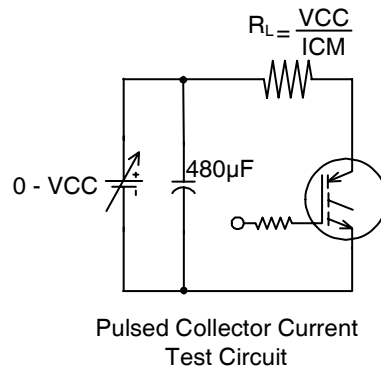
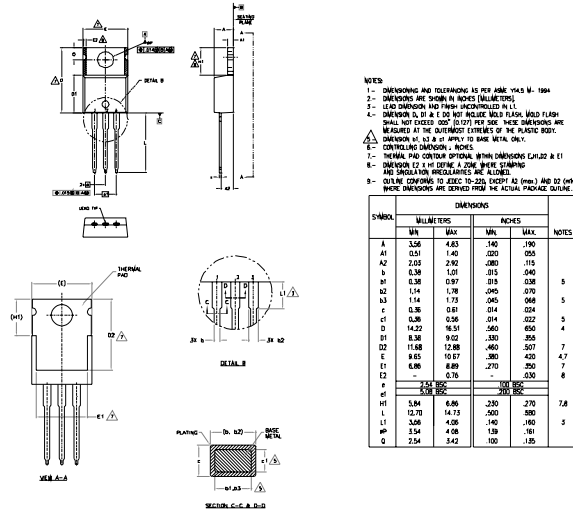

Figure 20. Pulsed Collector Current Test Circuit

IRG4BC20SDPbF



TO-220AB Package Outline (Dimensions are shown in millimeters (inches))



TO-220AB Part Marking Information

EXAMPLE: THIS IS AN IRF1010
 LOT CODE 1789
 ASSEMBLED ON WW 19, 1997
 IN THE ASSEMBLY LINE 'C'
Note: "P" in assembly line position indicates "Lead-Free"

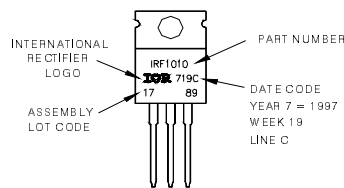

Note: For the most current drawing please refer to IR website at <http://www.irf.com/package/>

Notes:

- ① Repetitive rating: $V_{GE}=20V$; pulse width limited by maximum junction temperature (figure 20)
- ② $V_{CC}=80\%(V_{CES})$, $V_{GE}=20V$, $L=10\mu H$, $R_G = 50\Omega$ (figure 19)
- ③ Pulse width $\leq 80\mu s$; duty factor $\leq 0.1\%$.
- ④ Pulse width 5.0 μs , single shot.

Data and specifications subject to change without notice.



IR WORLD HEADQUARTERS: 233 Kansas St., El Segundo, California 90245, USA Tel: (310) 252-7105
 TAC Fax: (310) 252-7903

Visit us at www.irf.com for sales contact information. 01/2010