

# Electro-Chemical Oxygen (3-Wired Type) Transmitter O2-CD300(LG)



O2-CD300(G)



O2-CD300(LG)  
(with LCD display)

## General

O2-CD300(LG) is a 3wired Electro-Chemical type transmitter which measure 0~25% O2 gas with accuracy, repeatability and stability. Given O2 measurement, could secure innocent people from accident of lack/excessive of O2 gas exposure.

## Features

- 15years knowhow based multiplied compensation algorithms keep accuracy and long-term stabilization throughout full operating Temperature and Concentration range.
- Either of four (2 set of Analog Voltage or 2 set Current) output can be chosen by Jumper. (4~20mA/2~10V/0~20mA/0~10V)
- All units verification in factory before delivery.
- Easier mgmt with simple calibration usage, either 'span only at fresh air' or 'span after zero-cal.
- Size : 124 x 70 x 43 (mm), 110g, 120g : LCD(o)

※ Design or Specification of O2-CD300(LG) Series might be changed for better performance without prior notice.

## O2-CD300(LG)

### Application

Fixed type instrument and detector, measuring oxygen gas concentration, giving alarm when too low O2 gas concentration on fire outbreak in pensions, restaurants, etc.

### General Performance

#### Operating Temperature range

-20°C ~ 50°C

#### Operating Humidity range

10 ~ 95% RH (Non-condensing)

(‘G’ option: operatable upto 10~99% RH with Non-Condensing and protect from rustness)

#### Storage Temperature

5°C ~20°C (Higher temp. shorten sensor life.)

### Measurement

#### Sensing Method

Eletro-Chemical type to sense O2 gas

#### Measurement Range

0~25%

#### Accuracy

±2% of F.S

#### Response Time

T90 : < 45sec, T60 : < 30sec

#### Sampling Interval

1 second

#### Life Cycle

2 years.

### Electrical Data

#### Input Power

24VDC± 20%, (3-Wired)

#### Power consumption

0.7 Watt

### Wiring Method

1. VIN+: 24VDC+

2. VIN-: Common-GND

3. A-OUT: Output Signal (Voltage or Current)

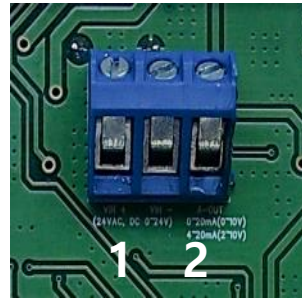

Wire connector.

※Warning : Please careful not to wire power cable into signal output position of terminal block, which leads to damage sensors .

### Dimensions (unit : mm)



## Output Signals



4 ~ 20mA is default (2 ~ 10VDC or 0 ~ 20mA or 0 ~ 10VDC is selectable with jumper setting change)

### ■ Jumper A (J7, J3) : Set Voltage/Current

#### ● [J7,J3] Output Mode

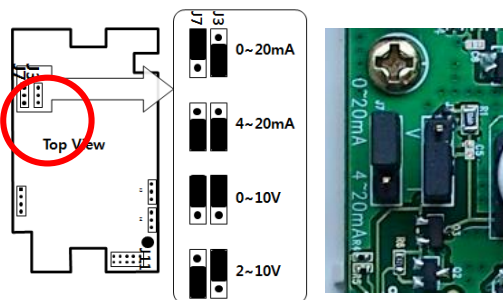

Ex) 0 ~ 20mA setting.

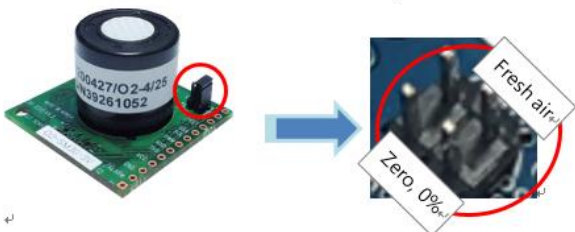

※ O2 ppm deviation from 20.7% is narrowed by Temperature difference compensation.

- ✚ O2-CD300(LG) shows good accuracy with linearity, temperature compensation, and fast response throughout all concentration, temperature, time range.

## Operation Mode selection

**Normal mode-#1** is for mobile or fixed type O2-meter installed where always 5ppm or more of O2 gas existing environment.

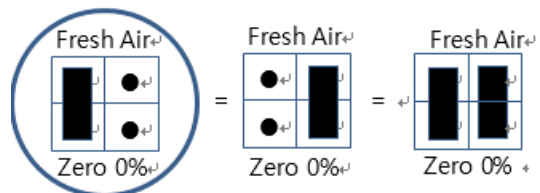

**Manual Zero Cal. mode-#2** is used to calibrate sensor with 0% O2 standard gas. Please make sure to locate O2-gas sensors on O2-gas-free area and move jumper setting from #1 to #2, which calibrate every minute. After calibration, return to previous set #1.



### Manual SPAN Cal. Mode -#3(=Manual Fresh Air Cal. Mode)

is used to calibrate O2-gas sensors after #3 calibration. Please install O2-sensors on EK-100SL or TRB-100ST and locate in chamber like CMB-10 and calibrate with standard 20.7% or fresh air, following zero calibration which calibrate every minute. After calibration, return to previous set #1.

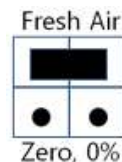

### ■ Analog output calculation

\* Output signal calculation examples

Ex) should the measurement range of 0~10V set and measured voltage is 8.10V,  
 $(8.10V-0V) \times (25\%/10V) = 20.25\%$

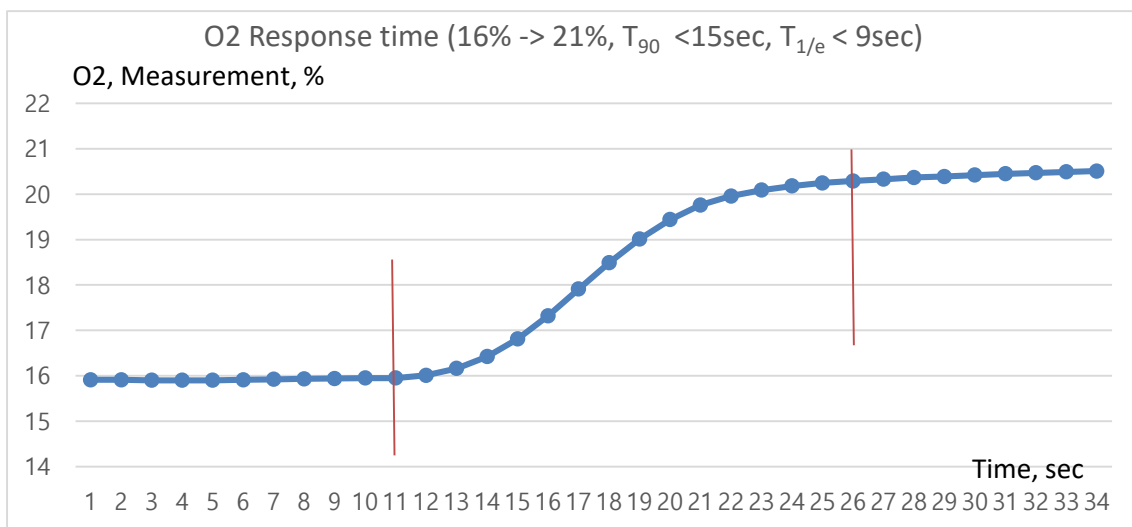
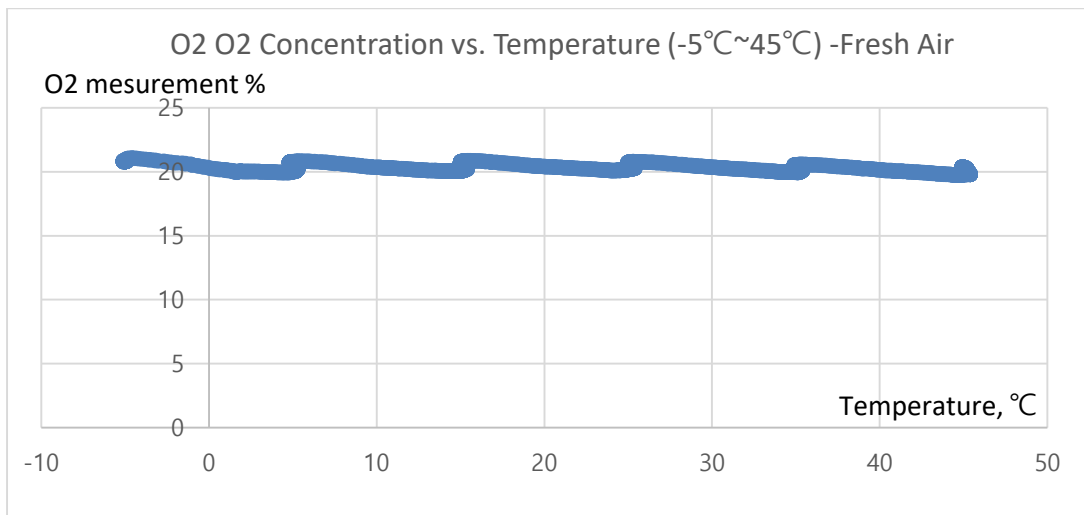
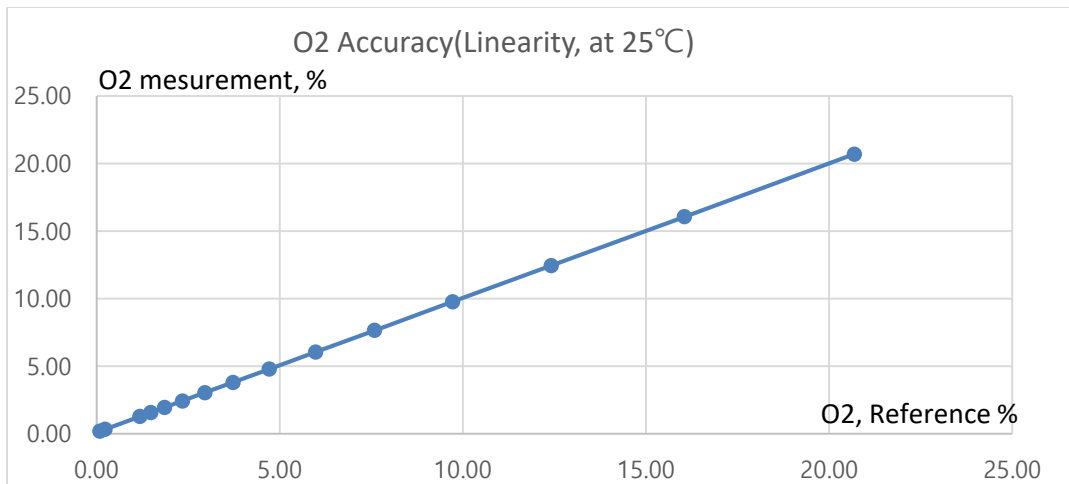

### Cautions on Installation

- I. Chemical sensors should be kept 5~20°C and better to installed within 3 months from purchase so as not to shorten their lifecycle.
- II. Installation near to nose height of 1.5~2m is desirable because O2 sensors are designed to keep lifecycle when installed normal living condition unless effected physically, mechanically or chemically.
- III. Sensor-detection part or PCB part should be kept from dirties, water or oil spraying which cause damage. and keep Sensors away from the solvent or high concentration organic gas existence or continuous vibration, or impulse from.
- IV. Power should be selected within tolerance and wired into right position, Sensor get damaged when 24V power is inserted into output.
- V. Chemical sensor modules' replacement should be done carefully not to pluck away sensor modules; Please grip the upside and downside of PCB , arrow-direction of picture, between 4-pins and 10pins connectors on unplugging sensor-module from main-board little by little, left and right in turn. Vice versa on plugging the sensor-module into main-board.
- VI. Please install or keep sensors away from the places where electro-static or induced electro-magnetic field exists.
- VII. Please make sure to use air-based standard gas on Test Sensor performance.
- VIII. The sensors' jumper-setting and components should be departed or replaced, or manipulated unless request or agree by vendor, Please don't touch electrolyte leaked from sensor when it is damaged or broken. Wash out skins with running water when wet by leaked electrolyte.

