

# STN265033U380

## TVS Diode array ESD suppressor



### Product features

- 450 Watts peak pulse power per line ( $t_p = 8/20 \mu s$ )
- Protects four I/O lines and one  $V_{CC}$  line
- Low clamping voltage
- Ultra low capacitance: <3 pF for high-speed interfaces
- Working voltage: 3.3 V
- Low leakage current
- Meets moisture sensitivity level (MSL) 3
- Molding compound flammability rating: UL 94V-0
- Termination finish: Ni/Pd/Au

### Applications

- USB interfaces
- 10/100/1000 ethernet
- DVI interfaces
- Wireless data (WAN/LAN) systems
- Analog video
- T1/E1 secondary protection
- T3/E3 secondary protection

### Environmental compliance and general specifications

- IEC61000-4-2 (ESD)
  - $\pm 30$  kV (air)
  - $\pm 30$  kV (contact)
- IEC61000-4-5 (Lightning) 25 A (8/20  $\mu s$ )



### Ordering part number

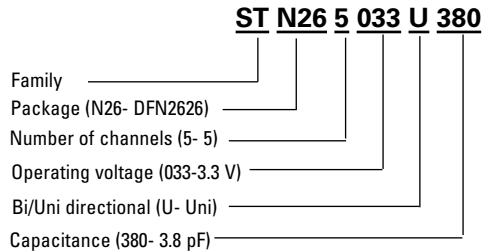

### Pin out/functional diagram

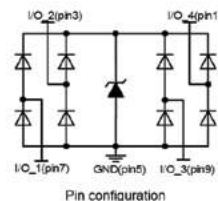
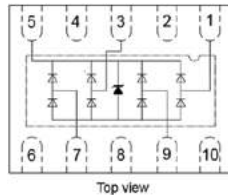
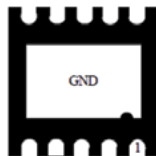

**Absolute maximum ratings**

(+25 °C, RH=45%-75%, unless otherwise noted)

**STN265033U380**

Parameter	Symbol	Value	Unit
Peak pulse power dissipation on 8/20 μs waveform	$P_{PP}$	450	W
ESD per IEC 61000-4-2 (Air)	$V_{ESD}$	+/-30	kV
ESD per IEC 61000-4-2 (Contact)		+/-30	
Lead soldering temperature	$T_L$	+260 (10 seconds)	°C
Operating junction temperature range	$T_J$	-55 to +125	°C
Storage temperature range	$T_{STG}$	-55 to +150	°C

**Electrical characteristics**

(+25 °C)

**STN265033U380**

Parameter	Test condition	Minimum	Typical	Maximum	Symbol (Units)
Reverse working voltage	Any pin to ground	-	-	3.3	$V_{RWM}$ (V)
Reverse breakdown voltage	$I_r = 1$ mA pin to ground	3.7	-	-	$V_{BR}$ (V)
Reverse holding voltage	$I_h = 50$ mA	3.5	-	-	$V_h$ (V)
Reverse leakage current	$V_{RWM} = 3.3$ V	-	-	0.1	$I_R$ (μA)
Clamping voltage	$I_{PP} = 5$ A, $t_p = 8/20$ μs I/O pin to GND	-	-	10	$V_c$ (V)
	$I_{PP} = 25$ A, $t_p = 8/20$ μs I/O pin to GND	-	-	16	$V_c$ (V)
Junction capacitance	$V_{RWM} = 0$ V, $f = 1$ MHz Between I/O pins	-	2	-	$C_j$ (pF)
	$V_{RWM} = 0$ V, $f = 1$ MHz I/O pin to GND	-	3.8	5	$C_j$ (pF)

**Mechanical parameters, pad layout- mm/inches**

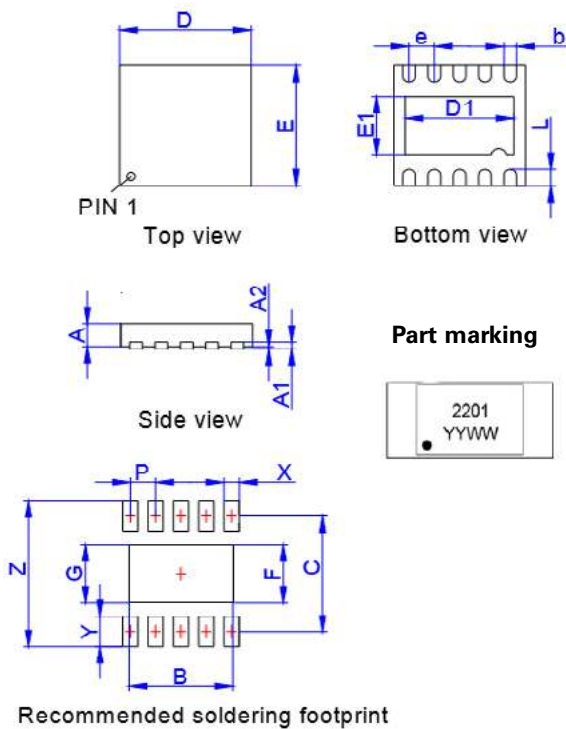

Dimension	Millimeters			Inches		
	Minimum	Typical	Maximum	Minimum	Typical	Maximum
D	2.55	2.60	2.65	0.100	0.102	0.104
E	2.55	2.60	2.65	0.100	0.102	0.104
D1	2.10	2.15	2.20	0.083	0.085	0.087
E1	1.21	1.26	1.31	0.048	0.050	0.052
L	0.30	0.35	0.40	0.012	0.014	0.016
b	0.20	0.25	0.30	0.008	0.010	0.012
e	0.50 BSC			0.020 BSC		
A	0.45	0.50	0.55	0.018	0.020	0.022
A1	0.15 REF			0.006 REF		
A2	0.00	0.02	0.05	0.000	0.001	0.002
B	2.05			0.081		
C	2.50			0.098		
F	1.26			0.050		
G	1.85			0.073		
P	0.50			0.020		
X	0.30			0.012		
Y	0.65			0.026		
Z	3.15			0.124		

**Packaging information mm/inches**

Drawing not to scale.

Supplied in tape and reel packaging, 3,000 parts per 7" diameter reel (EIA-481 compliant)

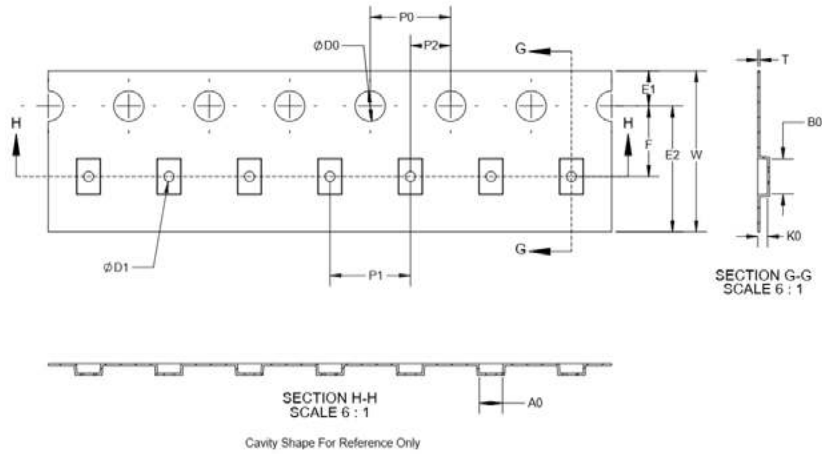

W	8.00
F	3.50
E1	1.75
E2	N/A
P0	4.00
P1	4.00
P2	2.00
ØD0	1.50
ØD1	N/A
A0	2.73
B0	2.78
K0	0.97
T	N/A

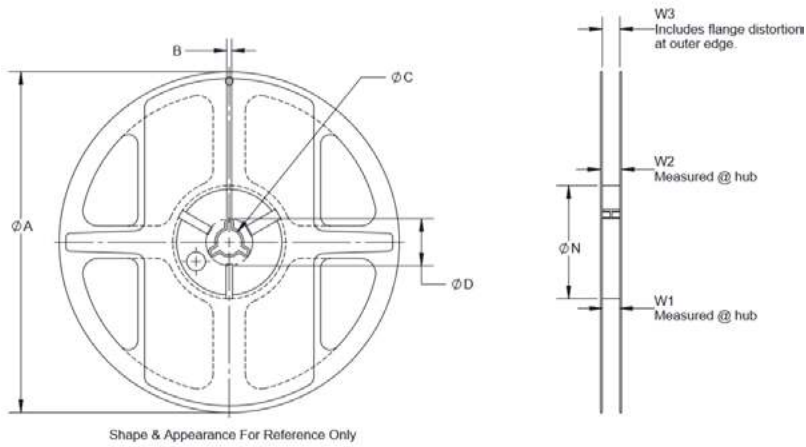

A	178.00
B	N/A
C	13.00
D	N/A
N	54.40
W1	9.50
W2	12.30
W3	N/A

**Ratings and V-I characteristic curves** (+25 °C unless otherwise noted)

**V- I curve characteristics (Uni-directional)**

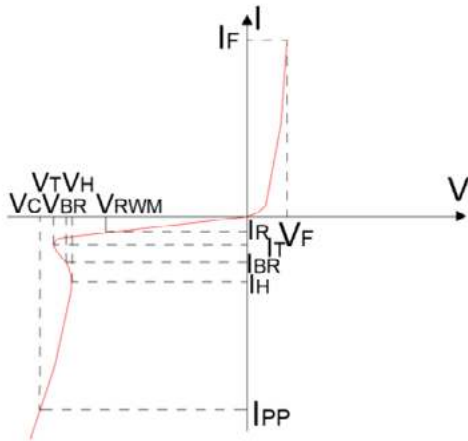

**Pulse waveform (8/20 μs)**

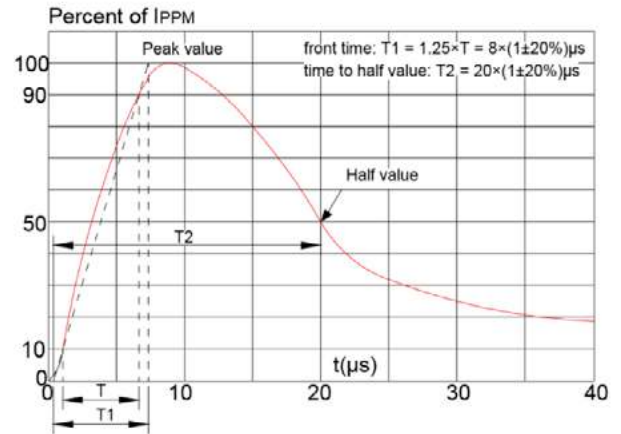

**Pulse derating curve**

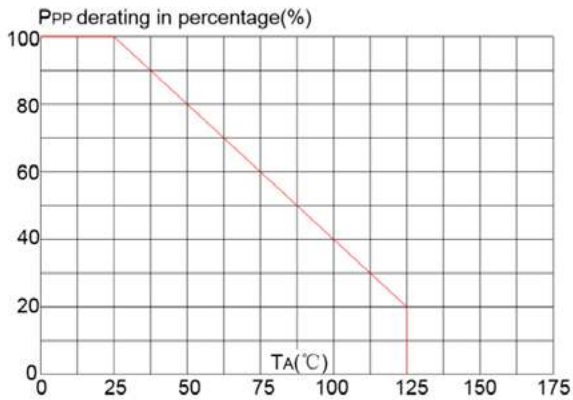

**ESD waveform**

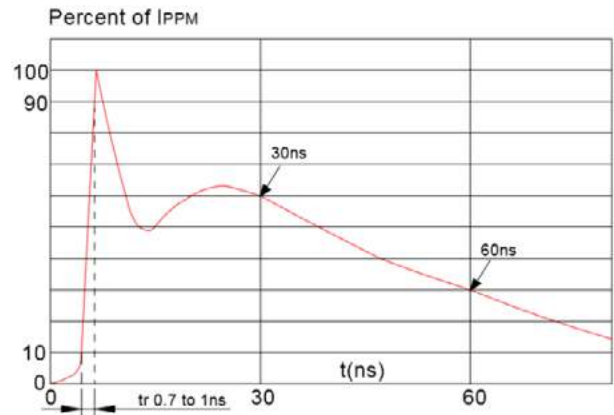

**Solder reflow profile**

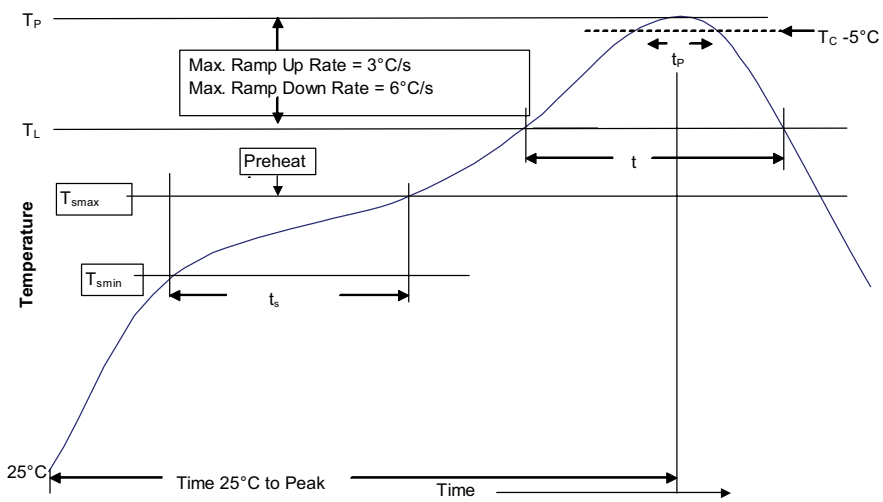

**Table 1 - Standard SnPb solder (T<sub>C</sub>)**

Package thickness	Volume mm <sup>3</sup> <350	Volume mm <sup>3</sup> ≥350
<2.5 mm	235 °C	220 °C
≥2.5 mm	220 °C	220 °C

**Table 2 - Lead (Pb) free solder (T<sub>C</sub>)**

Package thickness	Volume mm <sup>3</sup> <350	Volume mm <sup>3</sup> 350 - 2000	Volume mm <sup>3</sup> >2000
<1.6 mm	260 °C	260 °C	260 °C
1.6 – 2.5 mm	260 °C	250 °C	245 °C
>2.5 mm	250 °C	245 °C	245 °C

**Reference J-STD-020**

Profile feature	Standard SnPb solder	Lead (Pb) free solder
Preheat and soak		
• Temperature min. (T <sub>smin</sub> )	100 °C	150 °C
• Temperature max. (T <sub>smax</sub> )	150 °C	200 °C
• Time (T <sub>smin</sub> to T <sub>smax</sub> ) (t <sub>s</sub> )	60-120 seconds	60-120 seconds
Ramp up rate T <sub>L</sub> to T <sub>p</sub>	3 °C/ second max.	3 °C/ second max.
Liquidous temperature (T <sub>L</sub> )	183 °C	217 °C
Time (t <sub>L</sub> ) maintained above T <sub>L</sub>	60-150 seconds	60-150 seconds
Peak package body temperature (T <sub>p</sub> )*	Table 1	Table 2
Time (t <sub>p</sub> )* within 5 °C of the specified classification temperature (T <sub>C</sub> )	20 seconds*	30 seconds*
Ramp-down rate (T <sub>p</sub> to T <sub>L</sub> )	6 °C/ second max.	6 °C/ second max.
Time 25 °C to peak temperature	6 minutes max.	8 minutes max.

\* Tolerance for peak profile temperature (T<sub>p</sub>) is defined as a supplier minimum and a user maximum.

Life Support Policy: Eaton does not authorize the use of any of its products for use in life support devices or systems without the express written approval of an officer of the Company. Life support systems are devices which support or sustain life, and whose failure to perform, when properly used in accordance with instructions for use provided in the labeling, can be reasonably expected to result in significant injury to the user.

Eaton reserves the right, without notice, to change design or construction of any products and to discontinue or limit distribution of any products. Eaton also reserves the right to change or update, without notice, any technical information contained in this bulletin.

**Eaton**  
Electronics Division  
1000 Eaton Boulevard  
Cleveland, OH 44122  
United States  
Eaton.com/electronics

© 2020 Eaton  
All Rights Reserved  
Printed in USA  
Publication No. 11144 BU-MC20126  
September 2020

Eaton is a registered trademark.  
All other trademarks are property of their respective owners.

Follow us on social media to get the latest product and support information.

