

1 Features and Benefits

- Wide operating voltage range: from 3.3V to 18V
- Less than 10 μ A average supply current in μ -Power Mode
- Flexible magnetic thresholds and temperature coefficient
- Integrated self-diagnostic functions activating dedicated Safe Mode
- Reverse supply voltage protection
- Under-Voltage Reset protection
- Thermal protection
- Optional IMC integration for lateral sensing
- Customer end-of-line programming
- Wide programmable magnetic Latch/Switch range
- Developed according to ISO26262-10, 9 as safety HW element out of context with ASIL-B level
- MLX92292 = Programmable with PTC04
MLX92291/71 = Melexis Pre-programmed

2 Application Examples

- Automotive, Consumer and Industrial
- Brake light wake-up switch
- Electronic Steering Column Lock
- Door latch system
- Seat positioning
- Sunroof/Tailgate opener
- Transmission applications
- Electrical power steering

3 Ordering Information

Product Code	Temperature Code	Package Code	Option Code	Packing Form Code
MLX92292	L	SE	AAA-000	RE
MLX92292	L	UA	AAA-000	BU
MLX92292	L	SE	AAA-200	RE
MLX92292	L	DC	AAA-000	RE
MLX92292	L	SE	AAA-001	RE
MLX92291	L	SE	AAA-002	RE
MLX92291	L	SE	AAA-005	RE
MLX92291	L	SE	AAA-006	RE
MLX92291	L	SE	AAA-007	RE
MLX92291	L	SE	AAA-008	RE
MLX92291	L	SE	AAA-009	RE
MLX92291	L	SE	AAA-010	RE
MLX92291	L	SE	AAA-011	RE
MLX92291	L	SE	AAA-012	RE
MLX92291	L	SE	AAA-013	RE
MLX92291	L	SE	AAA-200	RE
MLX92291	L	SE	AAA-201	RE
MLX92291	L	SE	AAA-202	RE
MLX92291	L	SE	AAA-203	RE
MLX92291	L	SE	AAA-204	RE
MLX92291	L	SE	AAA-207	RE
MLX92271	L	SE	AAA-001	RE
MLX92271	L	SE	AAA-014	RE
MLX92271	L	SE	AAA-205	RE
MLX92271	L	SE	AAA-206	RE
MLX92271	L	SE	AAA-209	RE

Legend:

- Temperature Code: L (-40°C to 150°C)
- Package Code: SE = TSOT-3L
UA = TO92-3L
DC = SOIC-8 (dual die)
- Option Code: 0xx => normal version (perpendicular sensitive)
2xx => IMC version (lateral sensitive)
- Packing Form: BU=Bulk | RE = Reel | CA = Ammopack | CR = Carton on Reel
- Ordering example: MLX92292LSE-AAA-000-RE

4 Functional Diagram

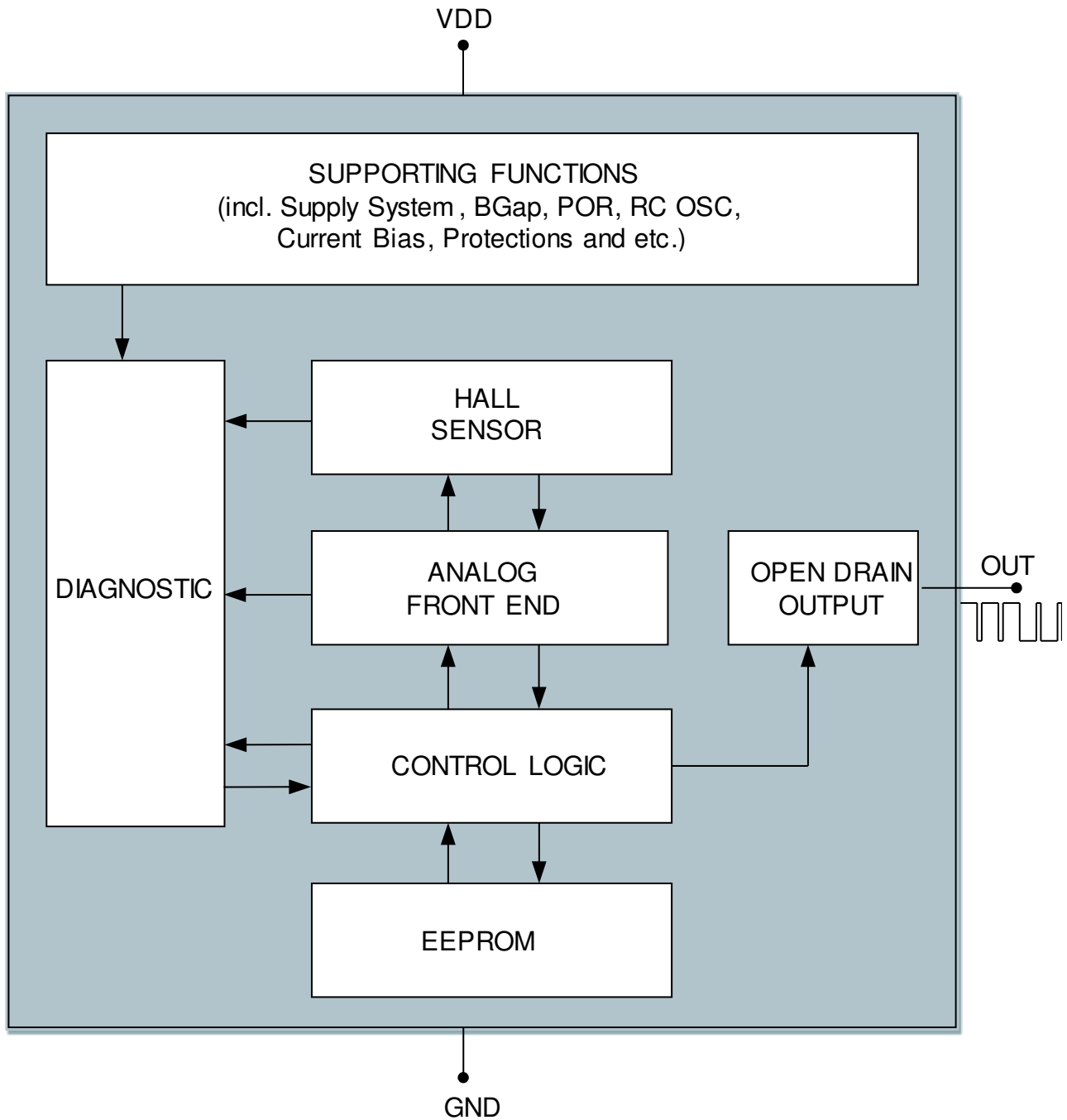

5 General Description

Melexis has made a major advance in magnetic sensing technology that will have widespread implications for modern automobile design the MLX92292 - effectively represents a whole new way of sensing. This device delivers switch functions, but unlike existing products on the market it can determine the presence of magnetic fields that are lateral, not just orthogonal, to it. The uniqueness of this offering is taken further by the fact that the MLX92292 switch is supporting an ASIL B safety integrity level (in accordance with ISO 26262), with an array of built-in diagnostic mechanisms available.

Flexibility is a key attribute of the MLX92292. OEM customers can choose straightforward pre-programmed units, or alternatively they can benefit from the end-of-line (EoL) programming capacity. Through this each device may be configured (via its output pin) during the OEM production process, so system optimization is fully realized. The programming facility also enables setting of both magnetic operating points to small increments across a range spanning -90mT to +90mT (-40mT to +40mT for lateral sensing versions).

The MLX92292 can be specified with standard orthogonal sensitivity or the lateral sensitivity option. The upshot of lateral sensitivity being that there is potential to replace multiple devices with a single surface mount unit, thereby saving valuable board space and lowering bill-of-materials costs. This stems directly from Melexis' proprietary Integrated Magnetic Concentrator (IMC™) technology, which enables substantial heightening of signal-to-noise ratios in magnetic field measurement. In addition, the capacity of this technology to sense laterally allows lower profile system implementations, as the magnet can move alongside the device rather than having to be above it.

Safeguarding the MLX92292 are reverse supply voltage, thermal, electro-static discharge (ESD) and over-voltage protections, plus Under-Voltage Reset features. With the capacity to deal with a 40V load dump, it can be connected directly to the vehicle battery. In order to achieve ASIL B compliance, numerous diagnostic/monitoring functions have been incorporated, including Hall sensor and analog frontend diagnostics. The device comprises a full set of programmable reporting features, giving it compatibility with any existing electronic control unit (ECU) interface. Only the normal application pins are required for this - without need of additional diagnostic pins and thus simplifying the design concept considerably.

Table of Contents

1	Features and Benefits	1
2	Application Examples	1
3	Ordering Information	1
4	Functional Diagram	2
5	General Description	3
6	Absolute Maximum Ratings	6
7	General Electrical Specifications	7
8	Version specific parameters	9
8.1	MLX92292LSE-AAA-000-RE/MLX92292LUA-AAA-000-BU/MLX92292LDC-AAA-000-RE	9
8.2	MLX92292LSE-AAA-200-RE	10
8.3	MLX92292LSE-AAA-001-RE	11
8.4	MLX92291LSE-AAA-002-RE	11
8.5	MLX92291LSE-AAA-005-RE	11
8.6	MLX92291LSE-AAA-006-RE	12
8.7	MLX92291LSE-AAA-007-RE	12
8.8	MLX92291LSE-AAA-008-RE	12
8.9	MLX92291LSE-AAA-009-RE	13
8.10	MLX92291LSE-AAA-010-RE	13
8.11	MLX92291LSE-AAA-011-RE	13
8.12	MLX92291LSE-AAA-012-RE	14
8.13	MLX92291LSE-AAA-013-RE	14
8.14	MLX92291LSE-AAA-200-RE	14
8.15	MLX92291LSE-AAA-201-RE	15
8.16	MLX92291LSE-AAA-202-RE	15
8.17	MLX92291LSE-AAA-203-RE	15
8.18	MLX92291LSE-AAA-204-RE	16
8.19	MLX92291LSE-AAA-207-RE	16
8.20	MLX92271LSE-AAA-001-RE	16
8.21	MLX92271LSE-AAA-014-RE	17
8.22	MLX92271LSE-AAA-205-RE	17
8.23	MLX92271LSE-AAA-206-RE	17
8.24	MLX92271LSE-AAA-209-RE	18

9	Magnetic Behaviour	20
9.1	Latch Sensor	20
9.2	Unipolar Switch Sensor	20
10	Functional Safety Capability	22
10.1	Sensor Development	22
10.2	Technical Safety Requirements	22
11	Application Information	24
11.1	Typical Automotive Application Circuit	24
11.2	Automotive and Harsh, Noisy Environments Application Circuit	24
12	Package Information	25
12.1	TSOT-3L (SE Package)	25
12.2	TO92-3L (UA Package)	27
12.3	SOIC8 (DC Package)	29
13	Standard information regarding manufacturability	32
14	ESD Precautions	32
15	Contact	33
16	Disclaimer	33

6 Absolute Maximum Ratings

Parameter	Symbol	Value	Units
Supply voltage ^(1, 2)	V _{DD}	+28V	V
Supply voltage (Load Dump) ^(1, 4)	V _{DD}	+ 45V	V
Supply current ^(1, 2, 3)	I _{DD}	+20	mA
Supply current ^(1, 3, 4)	I _{DD}	+50	mA
Reverse supply voltage ^(1, 2)	V _{DDREV}	-24	V
Reverse supply voltage ^(1, 4)	V _{DDREV}	-30	V
Reverse supply current ^(1, 2, 5)	I _{DDREV}	-20	mA
Reverse supply current ^(1, 4, 5)	I _{DDREV}	-40	mA
Output voltage ^(1, 2)	V _{OUT}	+28	V
Output current ^(1, 2, 5)	I _{OUT}	+20	mA
Reverse output voltage ⁽¹⁾	V _{OUTREV}	-0.5	V
Reverse output current ^(1, 2)	I _{OUTREV}	-50	mA
Maximum junction temperature ⁽⁶⁾	T _J	+165	°C
ESD sensitivity – HBM ⁽⁷⁾	-	8	kV
ESD sensitivity – CDM ⁽⁸⁾	-	1000	V

Exceeding the absolute maximum ratings may cause permanent damage. Exposure to absolute-maximum-rated conditions for extended periods may affect device reliability.

¹ The maximum junction temperature should not be exceeded

² For maximum 1 hour

³ Including current through protection device

⁴ For maximum 500ms

⁵ Through protection device

⁶ For 1000 hours.

⁷ Human Body Model according AEC-Q100-002 standard

⁸ Charged Device Model according AEC-Q100-011 standard

7 General Electrical Specifications

DC Operating Parameters $V_{DD} = 3.3V$ to $18V$, $T_A = -40^{\circ}C$ to $150^{\circ}C$ (unless otherwise specified)

Parameter	Symbol	Test Conditions	Min	Typ ⁽¹⁾	Max	Units
Under-Voltage Reset threshold	V_{UVR}	V_{DD} monitoring during Active phase	1.8	2.5	3	V
UVR reaction time ⁽²⁾	t_{UVR}	V_{DD} monitoring during Active phase, $V_{DD} = V_{UVR} - 0.3V$	—	1	—	μs
Minimum supply voltage for defined output state ⁽²⁾	V_{DD1}	$R_{PU} = 2.2k\Omega$, $V_{PU} = 5V$	—	1	1.2	V
Output leakage ⁽⁸⁾	I_{OFF}	$V_{OUT} = 18V$, $T_A = -40..85^{\circ}C$	—	0.1	1	μA
Output leakage	I_{OFF}	$V_{OUT} = 18V$	—	—	5	μA
Output saturation voltage	V_{OL}	Fast Mode, $I_{OL} = 20mA$	0.1	0.25	0.7	V
Output saturation voltage	V_{OL}	μ -Power Mode, $I_{OL} = 10mA$	—	0.15	0.5	V
Output Rise Time ^(2,5) (R_{PU} dependent)	t_R	$R_{PU} = 2.2k\Omega$, $V_{DD} = 12V$, $V_{PU} = 5V$ $C_{LOAD} = 50pF$ to GND	0.3	0.6	1	μs
Output Fall Time ^(2,5) (On-chip controlled)	t_F	$R_{PU} = 2.2k\Omega$, $V_{DD} = 12V$, $V_{PU} = 5V$ $C_{LOAD} = 50pF$ to GND	0.3	0.6	1	μs
Power-On time ^(3, 4)	t_{ON}	$V_{DD} = 5V$, $dV_{DD}/dt > 2V/\mu s$	—	0.5	1	ms
Power-On state	-	Output state during t_{ON}	High			—
Output update period	T_{UPD}	Fast Mode	—	40	45	μs
Programmable operating (output update) period	T_{OP}	μ -Power Mode, typical range	0.16 ⁽¹⁾	—	260 ⁽¹⁾	ms
Operating period 1 (1 st ref. value)	T_{OP1}	μ -Power Mode	196	222	246	ms
Operating period 2 (2 nd ref. value)	T_{OP2}	μ -Power Mode	40	45	50	ms
Programmable diagnostic period in Fail Safe state	T_{DP}	Fast Mode, typical range	0.13 ⁽¹⁾	—	260 ⁽¹⁾	ms
Programmable "Output Ticking" repetition period	T_{TICK}	Equal to (multiple of) T_{OP} , typical range	0.6 ⁽¹⁾	—	260 ⁽¹⁾	ms
Programmable "Output Ticking" duration	t_{TICK}	Typical range	4	—	128	μs
Active phase duration, diagnostic On	t_{ACT_Don}	μ -Power Mode, defined at $I_{DD} > 0.7mA$	—	40	—	μs
Active phase duration, diagnostic Off	t_{ACT_Doff}	μ -Power Mode, defined at $I_{DD} > 0.7mA$	—	24	—	μs
Tolerance of operating period ratio t_{ACT}/T_{OP}	R_{TOL}	μ -Power Mode	-5	0	5	%
Active phase supply current, diagnostic On (average value)	I_{DDACT_Don}	μ -Power Mode	1.8	2.4	2.9	mA
Active phase supply current, diagnostic Off (average value)	I_{DDACT_Doff}	μ -Power Mode	2.2	3	3.5	mA
Standby phase supply current ⁽⁸⁾	I_{DDSTBY}	$V_{DD} \leq 16V$, $T_A = -40..85^{\circ}C$	—	6	9	μA
Standby phase supply current	I_{DDSTBY}	$V_{DD} \leq 16V$	—	6	27	μA
Average supply current ^(8,9)	I_{DDAVG1}	$V_{DD} \leq 16V$, $T_A = -40..85^{\circ}C$, $T_{OP} = T_{OP1}$	—	6.4	9.5	μA
Average supply current ^(8,9)	I_{DDAVG2}	$V_{DD} \leq 16V$, $T_A = -40..85^{\circ}C$, $T_{OP} = T_{OP2}$	—	8.1	11.7	μA
Step response time ⁽²⁾	t_{RESP}	Fast Mode, $B_{OP} = 1mT$, $B_{RP} = -1mT$, square wave magnetic field with $B > \pm 4mT$, $t_{RISE} = t_{FALL} \leq 5\mu s$	15	40	65	μs
Signal bandwidth ^(2,6)	BW	Fast Mode, $B_{OP} = 1mT$, $B_{RP} = -1mT$, sine wave magnetic field with amplitude 5mT	6	8	—	kHz
Peak supply current ⁽²⁾	I_{DDPEAK}	For peak duration $\geq 5\mu s$	—	2.9	3.6	mA
Fast Mode supply current	I_{DDFAST}		2.2	2.9	3.5	mA
Fast Mode fail supply current	I_{DDFAIL}		0.1	0.3	0.6	mA
Reverse supply current	I_{DDREV}	$V_{DD} = -16V$	-1	—	—	mA

Thermal Protection Activation	T _{PROT}		—	185 ⁽⁷⁾	—	°C
Thermal Protection Release	T _{REL}		—	175 ⁽⁷⁾	—	°C
UA package thermal resistance	R _{THJA}	Single layer PCB, JEDEC standard test boards, still air (LFPM=0)	—	200	—	°C/W
SE package thermal resistance	R _{THJA}	Single layer PCB, JEDEC standard test boards, still air (LFPM=0)	—	300	—	°C/W

- 1 Unless otherwise specified the typical values are defined at T_A = +25°C and V_{DD} = 12V
- 2 Guaranteed by design and verified by characterization, not production tested
- 3 The Power-On Time represents the time from reaching V_{DD} = 3.3V to the first refresh of the output state.
- 4 Power-On Slew Rate is not critical for the proper device start-up.
- 5 R_{Pu} and V_{Pu} are respectively the external pull-up resistor and pull-up power supply
- 6 OUT switching should track magnetic field frequency without missing pulses
- 7 T_{PROT} and T_{REL} are the corresponding junction temperature values
- 8 Guaranteed by correlation with production test at T_A=150°C and verified by characterization
- 9 Average current consumption for μ-Power Mode with diagnostic On

$$I_{DDAVG} = \frac{I_{DDACT} * t_{ACT} * (1 + R_{TOL}/100) + I_{DDSTBY} * (T_{OP} - t_{ACT} * (1 + R_{TOL}/100))}{T_{OP}}$$

Where t_{act} and T_{OP} are always typical values. The maximum I_{DDACT}, I_{DDSTBY} and R_{TOL} spec values should be used for the maximum I_{DDAVG} calculation.

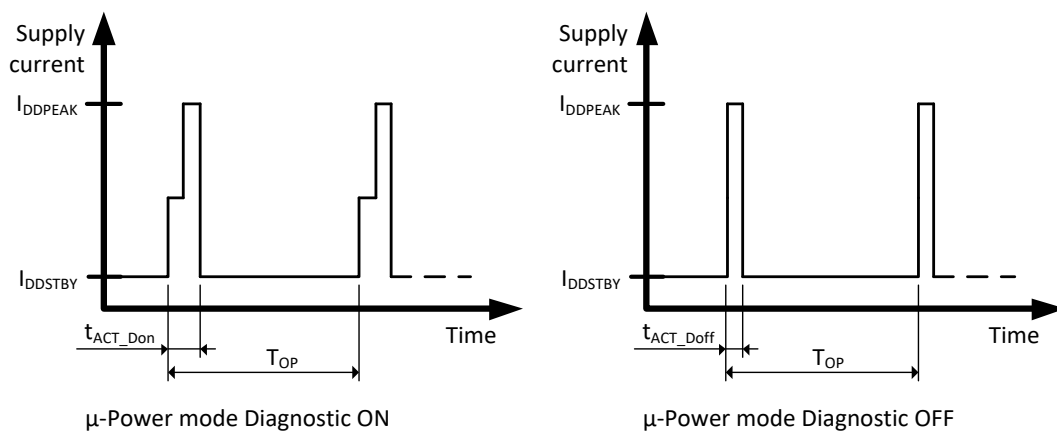
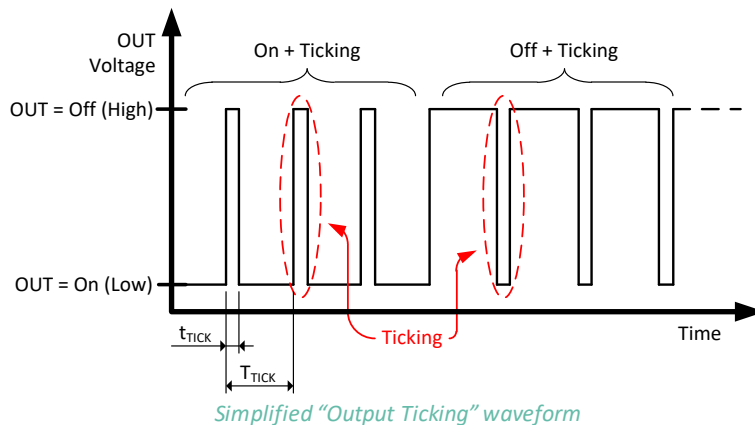

8 Version specific parameters

8.1 MLX92292LSE-AAA-000-RE/MLX92292LUA-AAA-000-BU/MLX92292LDC-AAA-000-RE

DC Operating Parameters $V_{DD} = 3.3V$ to $18V$, $T_A = -40^{\circ}C$ to $150^{\circ}C$ (unless otherwise specified)

Parameter	Symbol	Test Conditions	Min	Typ ⁽¹⁾	Max	
Operating Point programming range	BOP	$V_{DD} = 12V$, $T_A = 25^{\circ}C$	-90	—	90	mT
Release Point programming range	BRP	$V_{DD} = 12V$, $T_A = 25^{\circ}C$	-90	—	90	mT
Operating Point magnitude programming ^(2, 3)	BOP		—	12	—	bit
Release Point magnitude programming ^(2, 3)	BRP		—	12	—	bit
Operating Point polarity selection	BOP		—	1	—	bit
Release Point polarity selection	BRP		—	1	—	bit
Direct or inverted output selection	—		—	1	—	bit
Factory pre-programmed Operating Point, Latch	BOP	$V_{DD} = 12V$, $T_A = 25^{\circ}C$, programming target 25mT	22	25	28	mT
Factory pre-programmed Release Point, Latch	BRP	$V_{DD} = 12V$, $T_A = 25^{\circ}C$, programming target -25mT	-28	-25	-22	mT
Temperature Coefficient programming range ^(4,5,6)	TC	$V_{DD} = 12V$, Latch with BOP = 25mT, BRP = -25mT	-2400		0	ppm/ $^{\circ}C$
Temperature Coefficient selection	TC		—	5	—	bit

IMC	Safe message	Operating period, ms	Diagnostic period in Fail Safe state, ms	“Output Ticking” duration, μs	“Output Ticking” repetition period, ms
No	TickMsg	45	-	128	45

¹ Unless otherwise specified the typical values are defined at $T_A = +25^{\circ}C$ and $V_{DD} = 12V$

² The programming step is $<0.5\%$ of the programmed BOP or BRP value for $|BOP|$ or $|BRP| \geq 6mT$ and $<0.02mT$ for $|BOP|$ or $|BRP| \leq 6mT$ at $T_A = +25^{\circ}C$

³ Very low hysteresis magnitude ($BOP - BRP < 1mT$) could lead to output toggling due to noise and mechanical looseness in the magnetic system.

⁴ The Temperature Coefficient is calculated using following formula:

$$TC = \frac{B_{XPTA2} - B_{XPTA1}}{B_{XPTA1} * (T_{A2} - T_{A1})} * 10^6, ppm/^{\circ}C$$

where:

$$T_{A1} = 25^{\circ}C, T_{A2} = 150^{\circ}C,$$

In case of magnetic Latch application: B_{XPTA1} (B_{XPTA2}) = BOP-BRP at T_{A1} (T_{A2})

In case of magnetic Switch application: B_{XPTA1} (B_{XPTA2}) = BOP or BRP at T_{A1} (T_{A2})

⁵ The factory pre-programmed target TC value is 0ppm/ $^{\circ}C$.

⁶ TC target values

MLX92292/MLX92291/MLX92271

3-wire μ Power programmable ASIL B capable Hall Effect Latch/Switch

Datasheet

8.2 MLX92292LSE-AAA-200-RE

DC Operating Parameters $V_{DD} = 3.3V$ to $18V$, $T_A = -40^{\circ}C$ to $150^{\circ}C$ (unless otherwise specified)

Parameter	Symbol	Test Conditions	Min	Typ ⁽¹⁾	Max	
Operating Point programming range	BOP	$V_{DD} = 12V$, $T_A = 25^{\circ}C$	-40	—	40	mT
Release Point programming range	BRP	$V_{DD} = 12V$, $T_A = 25^{\circ}C$	-40	—	40	mT
Operating Point magnitude programming ^(2,3)	BOP		—	12	—	bit
Release Point magnitude programming ^(2,3)	BRP		—	12	—	bit
Operating Point polarity selection	BOP		—	1	—	bit
Release Point polarity selection	BRP		—	1	—	bit
Direct or inverted output selection	—		—	1	—	bit
Factory pre-programmed Operating Point, Latch	BOP	$V_{DD} = 12V$, $T_A = 25^{\circ}C$, programming target 20mT	17	20	23	mT
Factory pre-programmed Release Point, Latch	BRP	$V_{DD} = 12V$, $T_A = 25^{\circ}C$, programming target -20mT	-23	-20	-17	mT
Temperature Coefficient programming range ^(4,5,6)	TC	$V_{DD} = 12V$, Latch with BOP = 20mT, BRP = -20mT	-2400		0	ppm/ $^{\circ}C$
Temperature Coefficient selection	TC		—	5	—	bit

IMC	Safe message	Operating period, ms	Diagnostic period in Fail Safe state, ms	“Output Ticking” duration, μs	“Output Ticking” repetition period, ms
Yes	TickMsg	45	-	128	45

¹ Unless otherwise specified the typical values are defined at $T_A = +25^{\circ}C$ and $V_{DD} = 12V$

² The programming step is $<0.5\%$ of the programmed BOP or BRP value for $|BOP|$ or $|BRP| \geq 6mT$ and $<0.02mT$ for $|BOP|$ or $|BRP| \leq 6mT$ at $T_A = +25^{\circ}C$

³ Very low hysteresis magnitude ($BOP - BRP < 1mT$) could lead to output toggling due to noise and mechanical looseness in the magnetic system.

⁴ The Temperature Coefficient is calculated using following formula:

$$TC = \frac{B_{XPTA2} - B_{XPTA1}}{B_{XPTA1} * (T_{A2} - T_{A1})} * 10^6, ppm/^{\circ}C$$

where:

$$T_{A1} = 25^{\circ}C, T_{A2} = 150^{\circ}C,$$

In case of magnetic Latch application: B_{XPTA1} (B_{XPTA2}) = BOP-BRP at T_{A1} (T_{A2})

In case of magnetic Switch application: B_{XPTA1} (B_{XPTA2}) = BOP or BRP at T_{A1} (T_{A2})

⁵ The factory pre-programmed target TC value is 0ppm/ $^{\circ}C$.

⁶ TC target values

MLX92292/MLX92291/MLX92271

3-wire μ Power programmable ASIL B capable Hall Effect Latch/Switch

Datasheet



8.3 MLX92292LSE-AAA-001-RE

DC Operating Parameters $V_{DD} = 3.3$ to $18V$, $T_A = -40^\circ C$ to $150^\circ C$

Test Condition	Operating Point B_{OP} (mT)			Release Point B_{RP} (mT)			TC (ppm/ $^\circ C$)	Output behaviour	Active Pole
	Min	Typ ⁽¹⁾	Max	Min	Typ ⁽¹⁾	Max			
$T_A = -40^\circ C$	8.7	11.0	13.5	7.2	9.3	11.7	-1100 ⁽²⁾	Inverted switch	South pole
$T_A = 25^\circ C$	8.6	10.0	11.4	7.2	8.5	9.8			
$T_A = 150^\circ C$	6.7	8.6	10.7	5.6	7.4	9.4			

IMC	Safe message	Operating period, ms	Diagnostic period in Fail Safe state, ms	“Output Ticking” duration, μs	“Output Ticking” repetition period, ms
No	uNoDiag	0.16	-	-	-

8.4 MLX92291LSE-AAA-002-RE

DC Operating Parameters $V_{DD} = 3.3$ to $18V$, $T_A = -40^\circ C$ to $150^\circ C$

Test Condition	Operating Point B_{OP} (mT) ⁽³⁾			Release Point B_{RP} (mT) ⁽³⁾			TC (ppm/ $^\circ C$)	Output behaviour	Active Pole
	Min	Typ ⁽¹⁾	Max	Min	Typ ⁽¹⁾	Max			
$T_A = -40^\circ C$	11.5	14.5	17.6	6.6	9.1	11.8	-1100 ⁽²⁾	Direct switch	South pole
$T_A = 25^\circ C$	11.7	13.5	15.4	6.9	8.5	10.1			
$T_A = 150^\circ C$	8.7	11.6	14.9	4.9	7.3	10.0			

IMC	Safe message	Operating period, ms	Diagnostic period in Fail Safe state, ms	“Output Ticking” duration, μs	“Output Ticking” repetition period, ms
No	TickMsg	10	-	128	10

8.5 MLX92291LSE-AAA-005-RE

DC Operating Parameters $V_{DD} = 3.3$ to $18V$, $T_A = -40^\circ C$ to $150^\circ C$

Test Condition	Operating Point B_{OP} (mT)			Release Point B_{RP} (mT)			TC (ppm/ $^\circ C$)	Output behaviour	Active Pole
	Min	Typ ⁽¹⁾	Max	Min	Typ ⁽¹⁾	Max			
$T_A = -40^\circ C$	-8.5	-6.4	-4.4	-9.7	-7.5	-5.4	-1100 ⁽²⁾	Direct switch	North pole
$T_A = 25^\circ C$	-7.2	-6	-4.9	-8.2	-7	-5.8			
$T_A = 150^\circ C$	-7.2	-5.2	-3.3	-8.2	-6	-4			

IMC	Safe message	Operating period, ms	Diagnostic period in Fail Safe state, ms	“Output Ticking” duration, μs	“Output Ticking” repetition period, ms
No	OutOnMsg	50	-	-	-

¹ Unless otherwise specified the typical values are defined at $T_A = +25^\circ C$ and $V_{DD} = 12V$. Melexis production testing is limited to version specific parameters only.

² Typical TC programmed. The Temperature Coefficient is calculated using formula from section 8

³ Final magnetic parameters will be covered in the PPAP documentation set, the table below is based on theoretical calculations

MLX92292/MLX92291/MLX92271

3-wire μ Power programmable ASIL B capable Hall Effect Latch/Switch

Datasheet



8.6 MLX92291LSE-AAA-006-RE

DC Operating Parameters $V_{DD} = 3.3$ to $18V$, $T_A = -40^\circ C$ to $150^\circ C$

Test Condition	Operating Point B_{OP} (mT)			Release Point B_{RP} (mT)			TC (ppm/ $^\circ C$)	Output behaviour	Active Pole
	Min	Typ ⁽¹⁾	Max	Min	Typ ⁽¹⁾	Max			
$T_A = -40^\circ C$	-6.8	-4.8	-2.9	-7.9	-5.9	-3.9	-1000 ⁽²⁾	Inverted switch	North pole
$T_A = 25^\circ C$	-5.6	-4.5	-3.4	-6.6	-5.5	-4.4			
$T_A = 150^\circ C$	-5.8	-3.9	-2.1	-6.8	-4.8	-2.9			

IMC	Safe message	Operating period, ms	Diagnostic period in Fail Safe state, ms	“Output Ticking” duration, μs	“Output Ticking” repetition period, ms
No	uNoDiag	60	-	-	-

8.7 MLX92291LSE-AAA-007-RE

DC Operating Parameters $V_{DD} = 3.3$ to $18V$, $T_A = -40^\circ C$ to $150^\circ C$

Test Condition	Operating Point B_{OP} (mT) ⁽³⁾			Release Point B_{RP} (mT) ⁽³⁾			TC (ppm/ $^\circ C$)	Output behaviour	Active Pole
	Min	Typ ⁽¹⁾	Max	Min	Typ ⁽¹⁾	Max			
$T_A = -40^\circ C$	7.1	9.6	12.3	5.1	7.5	10.0	-1000 ⁽²⁾	Direct switch	South pole
$T_A = 25^\circ C$	7.4	9.0	10.6	5.5	7.0	8.6			
$T_A = 150^\circ C$	5.3	7.8	10.5	3.7	6.0	8.5			

IMC	Safe message	Operating period, ms	Diagnostic period in Fail Safe state, ms	“Output Ticking” duration, μs	“Output Ticking” repetition period, ms
No	TickMsg	10	-	128	10

8.8 MLX92291LSE-AAA-008-RE

DC Operating Parameters $V_{DD} = 3.3$ to $18V$, $T_A = -40^\circ C$ to $150^\circ C$

Test Condition	Operating Point B_{OP} (mT) ⁽³⁾			Release Point B_{RP} (mT) ⁽³⁾			TC (ppm/ $^\circ C$)	Output behaviour	Active Pole
	Min	Typ ⁽¹⁾	Max	Min	Typ ⁽¹⁾	Max			
$T_A = -40^\circ C$	-21.4	-18.1	-15	-22.6	-19.1	-16	-1100 ⁽²⁾	Direct switch	North pole
$T_A = 25^\circ C$	-18.7	-16.85	-15.1	-19.8	-17.85	-16			
$T_A = 150^\circ C$	-18.1	-14.5	-11.4	-19.1	-15.4	-12.1			

IMC	Safe message	Operating period, ms	Diagnostic period in Fail Safe state, ms	“Output Ticking” duration, μs	“Output Ticking” repetition period, ms
No	uNoDiag	44	-	-	-

¹ Unless otherwise specified the typical values are defined at $T_A = +25^\circ C$ and $V_{DD} = 12V$. Melexis production testing is limited to version specific parameters only.

² Typical TC programmed. The Temperature Coefficient is calculated using formula from section 8

³ Final magnetic parameters will be covered in the PPAP documentation set, the table below is based on theoretical calculations

MLX92292/MLX92291/MLX92271

3-wire μ Power programmable ASIL B capable Hall Effect Latch/Switch

Datasheet



8.9 MLX92291LSE-AAA-009-RE

DC Operating Parameters $V_{DD} = 3.3$ to $18V$, $T_A = -40^\circ C$ to $150^\circ C$

Test Condition	Operating Point B_{OP} (mT)			Release Point B_{RP} (mT)			TC (ppm/ $^\circ C$)	Output behaviour	Active Pole
	Min	Typ ⁽¹⁾	Max	Min	Typ ⁽¹⁾	Max			
$T_A = -40^\circ C$	-6.4	-4.5	-2.6	-7.5	-5.5	-3.6	0 ⁽²⁾	Inverted switch	North pole
$T_A = 25^\circ C$	-5.6	-4.5	-3.4	-6.6	-5.5	-4.4			
$T_A = 150^\circ C$	-6.6	-4.5	-2.5	-7.7	-5.5	-3.4			

IMC	Safe message	Operating period, ms	Diagnostic period in Fail Safe state, ms	“Output Ticking” duration, μs	“Output Ticking” repetition period, ms
No	uNoDiag	10	-	-	-

8.10 MLX92291LSE-AAA-010-RE

DC Operating Parameters $V_{DD} = 3.3$ to $18V$, $T_A = -40^\circ C$ to $150^\circ C$

Test Condition	Operating Point B_{OP} (mT) ⁽³⁾			Release Point B_{RP} (mT) ⁽³⁾			TC (ppm/ $^\circ C$)	Output behaviour	Active Pole
	Min	Typ ⁽¹⁾	Max	Min	Typ ⁽¹⁾	Max			
$T_A = -40^\circ C$	5.2	6.9	8.6	3.1	4.6	6.2	-1100 ⁽²⁾	Direct switch	South pole
$T_A = 25^\circ C$	5.2	6.4	7.6	3.2	4.3	5.4			
$T_A = 150^\circ C$	3.8	5.5	7.4	2.2	3.7	5.3			

IMC	Safe message	Operating period, ms	Diagnostic period in Fail Safe state, ms	“Output Ticking” duration, μs	“Output Ticking” repetition period, ms
No	TickMsg	10	-	128	10

8.11 MLX92291LSE-AAA-011-RE

DC Operating Parameters $V_{DD} = 3.3$ to $18V$, $T_A = -40^\circ C$ to $150^\circ C$

Test Condition	Operating Point B_{OP} (mT) ⁽³⁾			Release Point B_{RP} (mT) ⁽³⁾			TC (ppm/ $^\circ C$)	Output behaviour	Active Pole
	Min	Typ ⁽¹⁾	Max	Min	Typ ⁽¹⁾	Max			
$T_A = -40^\circ C$	-26.3	-22.3	-18.5	-28.7	-24.4	-20.4	-999 ⁽²⁾	Direct switch	North pole
$T_A = 25^\circ C$	-23.3	-20.9	-18.6	-25.4	-22.9	-20.5			
$T_A = 150^\circ C$	-22.8	-18.3	-14.3	-24.8	-20.0	-15.8			

IMC	Safe message	Operating period, ms	Diagnostic period in Fail Safe state, ms	“Output Ticking” duration, μs	“Output Ticking” repetition period, ms
No	TickOnMsg	0.86	-	128	1.72

¹ Unless otherwise specified the typical values are defined at $T_A = +25^\circ C$ and $V_{DD} = 12V$. Melexis production testing is limited to version specific parameters only.

² Typical TC programmed. The Temperature Coefficient is calculated using formula from section 8.

³ Final magnetic parameters will be covered in the PPAP documentation set, the table below is based on theoretical calculations

MLX92292/MLX92291/MLX92271

3-wire μ Power programmable ASIL B capable Hall Effect Latch/Switch

Datasheet



8.12 MLX92291LSE-AAA-012-RE

DC Operating Parameters $V_{DD} = 3.3$ to $18V$, $T_A = -40^\circ C$ to $150^\circ C$

Test Condition	Operating Point B_{OP} (mT) ⁽³⁾			Release Point B_{RP} (mT) ⁽³⁾			TC (ppm/ $^\circ C$)	Output behaviour	Active Pole
	Min	Typ ⁽¹⁾	Max	Min	Typ ⁽¹⁾	Max			
$T_A = -40^\circ C$	3.9	5.9	7.9	2.9	4.8	6.8	-1000 ⁽²⁾	Direct switch	South pole
$T_A = 25^\circ C$	4.4	5.5	6.6	3.4	4.5	5.6			
$T_A = 150^\circ C$	2.9	4.8	6.8	2.1	3.9	5.8			

IMC	Safe message	Operating period, ms	Diagnostic period in Fail Safe state, ms	“Output Ticking” duration, μs	“Output Ticking” repetition period, ms
No	uNoDiag	60	-	-	-

8.13 MLX92291LSE-AAA-013-RE

DC Operating Parameters $V_{DD} = 3.3$ to $18V$, $T_A = -40^\circ C$ to $150^\circ C$

Test Condition	Operating Point B_{OP} (mT) ⁽³⁾			Release Point B_{RP} (mT) ⁽³⁾			TC (ppm/ $^\circ C$)	Output behaviour	Active Pole
	Min	Typ ⁽¹⁾	Max	Min	Typ ⁽¹⁾	Max			
$T_A = -40^\circ C$	24.3	28.7	33.6	22.2	26.4	31.0	-1100 ⁽²⁾	Direct switch	South pole
$T_A = 25^\circ C$	24.2	26.8	29.6	22.1	24.6	27.2			
$T_A = 105^\circ C$ ⁽⁴⁾	20.3	24.2	29.0	18.5	22.4	26.8			
$T_A = 150^\circ C$	18.4	23.1	28.5	16.8	21.2	26.2			

IMC	Safe message	Operating period, ms	Diagnostic period in Fail Safe state, ms	“Output Ticking” duration, μs	“Output Ticking” repetition period, ms
No	uNoDiag	1	-	-	-

8.14 MLX92291LSE-AAA-200-RE

DC Operating Parameters $V_{DD} = 3.3$ to $18V$, $T_A = -40^\circ C$ to $150^\circ C$

Test Condition	Operating Point B_{OP} (mT)			Release Point B_{RP} (mT)			TC (ppm/ $^\circ C$)	Output behaviour	Active Pole
	Min	Typ ⁽¹⁾	Max	Min	Typ ⁽¹⁾	Max			
$T_A = -40^\circ C$	7.6	10.5	13.6	5.6	8.1	11	-2200 ⁽²⁾	Inverted switch	South pole
$T_A = 25^\circ C$	7	9	11	5.1	7	8.9			
$T_A = 150^\circ C$	4.5	6.6	8.9	3.2	5.2	7.2			

IMC	Safe message	Operating period, ms	Diagnostic period in Fail Safe state, ms	“Output Ticking” duration, μs	“Output Ticking” repetition period, ms
Yes	FldMsg	-	2	-	-

¹ Unless otherwise specified the typical values are defined at $T_A = +25^\circ C$ and $V_{DD} = 12V$. Melexis production testing is limited to version specific parameters only.

² Typical TC programmed. The Temperature Coefficient is calculated using formula from section 8.

³ Final magnetic parameters will be covered in the PPAP documentation set, the table below is based on theoretical calculations

⁴ Row “ $T_A = 105^\circ C$ ” is based on theoretical calculations only, not production tested.

MLX92292/MLX92291/MLX92271

3-wire μ Power programmable ASIL B capable Hall Effect Latch/Switch

Datasheet



8.15 MLX92291LSE-AAA-201-RE

DC Operating Parameters $V_{DD} = 3.3$ to $18V$, $T_A = -40^\circ C$ to $150^\circ C$

Test Condition	Operating Point B_{OP} (mT) ⁽³⁾			Release Point B_{RP} (mT) ⁽³⁾			TC (ppm/ $^\circ C$)	Output behaviour	Active Pole
	Min	Typ ⁽¹⁾	Max	Min	Typ ⁽¹⁾	Max			
$T_A = -40^\circ C$	7.0	9.6	12.5	6.7	9.3	12.1	-1100 ⁽²⁾	Inverted switch	South pole
$T_A = 25^\circ C$	7.0	8.8	10.7	6.7	8.5	10.4			
$T_A = 150^\circ C$	5.4	7.7	10.2	5.2	7.4	9.9			

IMC	Safe message	Operating period, ms	Diagnostic period in Fail Safe state, ms	“Output Ticking” duration, μs	“Output Ticking” repetition period, ms
Yes	uNoDiag	45	-	-	-

8.16 MLX92291LSE-AAA-202-RE

DC Operating Parameters $V_{DD} = 3.3$ to $18V$, $T_A = -40^\circ C$ to $150^\circ C$

Test Condition	Operating Point B_{OP} (mT)			Release Point B_{RP} (mT)			TC (ppm/ $^\circ C$)	Output behaviour	Active Pole
	Min	Typ ⁽¹⁾	Max	Min	Typ ⁽¹⁾	Max			
$T_A = -40^\circ C$	3.8	5.9	8.2	2.8	4.8	7.0	-1100 ⁽²⁾	Inverted switch	South pole
$T_A = 25^\circ C$	3.8	5.4	7.0	2.9	4.4	6.0			
$T_A = 150^\circ C$	2.8	4.7	6.8	2.0	3.9	5.8			

IMC	Safe message	Operating period, ms	Diagnostic period in Fail Safe state, ms	“Output Ticking” duration, μs	“Output Ticking” repetition period, ms
Yes	uNoDiag	10	-	-	-

8.17 MLX92291LSE-AAA-203-RE

DC Operating Parameters $V_{DD} = 3.3$ to $18V$, $T_A = -40^\circ C$ to $150^\circ C$

Test Condition	Operating Point B_{OP} (mT) ⁽³⁾			Release Point B_{RP} (mT) ⁽³⁾			TC (ppm/ $^\circ C$)	Output behaviour	Active Pole
	Min	Typ ⁽¹⁾	Max	Min	Typ ⁽¹⁾	Max			
$T_A = -40^\circ C$	-5.9	-3.6	-1.3	-7.0	-4.6	-2.3	-1100 ⁽²⁾	Direct switch	North pole
$T_A = 25^\circ C$	-4.8	-3.33	-1.8	-5.9	-4.33	-2.8			
$T_A = 150^\circ C$	-5.1	-2.9	-0.7	-6.0	-3.7	-1.6			

IMC	Safe message	Operating period, ms	Diagnostic period in Fail Safe state, ms	“Output Ticking” duration, μs	“Output Ticking” repetition period, ms
Yes	uNoDiag	44	-	-	-

¹ Unless otherwise specified the typical values are defined at $T_A = +25^\circ C$ and $V_{DD} = 12V$. Melexis production testing is limited to version specific parameters only.

² Typical TC programmed. The Temperature Coefficient is calculated using formula from section 8

³ Final magnetic parameters will be covered in the PPAP documentation set, the table below is based on theoretical calculations

MLX92292/MLX92291/MLX92271

3-wire μ Power programmable ASIL B capable Hall Effect Latch/Switch

Datasheet



8.18 MLX92291LSE-AAA-204-RE

DC Operating Parameters $V_{DD} = 3.3$ to $18V$, $T_A = -40^\circ C$ to $150^\circ C$

Test Condition	Operating Point B_{OP} (mT) ⁽³⁾			Release Point B_{RP} (mT) ⁽³⁾			TC (ppm/ $^\circ C$)	Output behaviour	Active Pole
	Min	Typ ⁽¹⁾	Max	Min	Typ ⁽¹⁾	Max			
$T_A = -40^\circ C$	-23.9	-19.9	-16.3	-24.4	-20.5	-16.8	-1100 ⁽²⁾	Direct switch	North pole
$T_A = 25^\circ C$	-20.9	-18.6	-16.4	-21.5	-19.1	-16.8			
$T_A = 150^\circ C$	-20.2	-16.0	-12.3	-20.7	-16.5	-12.7			

IMC	Safe message	Operating period, ms	Diagnostic period in Fail Safe state, ms	“Output Ticking” duration, μs	“Output Ticking” repetition period, ms
Yes	OutOnMsg	50	-	-	-

8.19 MLX92291LSE-AAA-207-RE

DC Operating Parameters $V_{DD} = 3.3$ to $18V$, $T_A = -40^\circ C$ to $150^\circ C$

Test Condition	Operating Point B_{OP} (mT) ⁽³⁾			Release Point B_{RP} (mT) ⁽³⁾			TC (ppm/ $^\circ C$)	Output behaviour	Active Pole
	Min	Typ ⁽¹⁾	Max	Min	Typ ⁽¹⁾	Max			
$T_A = -40^\circ C$	0.4	2.8	5.3	-0.5	1.9	4.3	-2000 ⁽²⁾	Direct switch	South pole
$T_A = 25^\circ C$	1.0	2.5	4.0	0.2	1.7	3.2			
$T_A = 150^\circ C$	-0.1	1.9	3.9	-0.7	1.3	3.3			

IMC	Safe message	Operating period, ms	Diagnostic period in Fail Safe state, ms	“Output Ticking” duration, μs	“Output Ticking” repetition period, ms
Yes	uNoDiag	6.8	-	-	-

8.20 MLX92271LSE-AAA-001-RE

DC Operating Parameters $V_{DD} = 3.3$ to $18V$, $T_A = -40^\circ C$ to $150^\circ C$

Test Condition	Operating Point B_{OP} (mT) ⁽³⁾			Release Point B_{RP} (mT) ⁽³⁾			TC (ppm/ $^\circ C$)	Output behaviour	Active Pole
	Min	Typ ⁽¹⁾	Max	Min	Typ ⁽¹⁾	Max			
$T_A = -40^\circ C$	-0.9	0.4	1.9	-1.9	-0.4	0.9	0 ⁽²⁾	Latch	South pole
$T_A = 25^\circ C$	-0.9	0.4	1.9	-1.9	-0.4	0.9			
$T_A = 150^\circ C$	-0.9	0.4	1.9	-1.9	-0.4	0.9			

IMC	Safe message	Operating period, ms	Diagnostic period in Fail Safe state, ms	“Output Ticking” duration, μs	“Output Ticking” repetition period, ms
No	FNoDiag	-	-	-	-

¹ Unless otherwise specified the typical values are defined at $T_A = +25^\circ C$ and $V_{DD} = 12V$. Melexis production testing is limited to version specific parameters only.

² Typical TC programmed. The Temperature Coefficient is calculated using formula from section 8

³ Final magnetic parameters will be covered in the PPAP documentation set, the table below is based on theoretical calculations

MLX92292/MLX92291/MLX92271

3-wire μ Power programmable ASIL B capable Hall Effect Latch/Switch

Datasheet



8.21 MLX92271LSE-AAA-014-RE

DC Operating Parameters $V_{DD} = 3.3$ to $18V$, $T_A = -40^\circ C$ to $150^\circ C$

Test Condition	Operating Point B_{OP} (mT) ⁽³⁾			Release Point B_{RP} (mT) ⁽³⁾			TC (ppm/ $^\circ C$)	Output behaviour	Active Pole
	Min	Typ ⁽¹⁾	Max	Min	Typ ⁽¹⁾	Max			
$T_A = -40^\circ C$	-0.1	2.1	4.5	-4.5	-2.1	0.1	-1100 ⁽²⁾	Latch	South pole
$T_A = 25^\circ C$	0.5	2.0	3.5	-3.5	-2.0	-0.5			
$T_A = 150^\circ C$	-0.4	1.7	3.9	-3.9	-1.7	0.4			

IMC	Safe message	Operating period, ms	Diagnostic period in Fail Safe state, ms	“Output Ticking” duration, μs	“Output Ticking” repetition period, ms
No	FNoDiag	-	-	-	-

8.22 MLX92271LSE-AAA-205-RE

DC Operating Parameters $V_{DD} = 3.3$ to $18V$, $T_A = -40^\circ C$ to $150^\circ C$

Test Condition	Operating Point B_{OP} (mT)			Release Point B_{RP} (mT)			TC (ppm/ $^\circ C$)	Output behaviour	Active Pole
	Min	Typ ⁽¹⁾	Max	Min	Typ ⁽¹⁾	Max			
$T_A = -40^\circ C$	-0.9	1.5	3.9	-3.9	-1.5	0.9	0 ⁽²⁾	Latch	South pole
$T_A = 25^\circ C$	-0.2	1.5	3.2	-3.2	-1.5	0.2			
$T_A = 150^\circ C$	-0.9	1.5	4.0	-4.0	-1.5	0.9			

IMC	Safe message	Operating period, ms	Diagnostic period in Fail Safe state, ms	“Output Ticking” duration, μs	“Output Ticking” repetition period, ms
Yes	FNoDiag	-	-	-	-

8.23 MLX92271LSE-AAA-206-RE

DC Operating Parameters $V_{DD} = 3.3$ to $18V$, $T_A = -40^\circ C$ to $150^\circ C$

Test Condition	Operating Point B_{OP} (mT) ⁽³⁾			Release Point B_{RP} (mT) ⁽³⁾			TC (ppm/ $^\circ C$)	Output behaviour	Active Pole
	Min	Typ ⁽¹⁾	Max	Min	Typ ⁽¹⁾	Max			
$T_A = -40^\circ C$	0.6	3.2	5.8	-5.8	-3.2	-0.6	-2200 ⁽²⁾	Latch	South pole
$T_A = 25^\circ C$	1.1	2.8	4.5	-4.5	-2.8	-1.1			
$T_A = 125^\circ C$ ⁽⁴⁾	0	2.2	4.4	-4.4	-2.2	0			
$T_A = 150^\circ C$	-0.1	2.0	4.2	-4.2	-2.0	0.1			

IMC	Safe message	Operating period, ms	Diagnostic period in Fail Safe state, ms	“Output Ticking” duration, μs	“Output Ticking” repetition period, ms
Yes	FNoDiag	-	-	-	-

¹ Unless otherwise specified the typical values are defined at $T_A = +25^\circ C$ and $V_{DD} = 12V$. Melexis production testing is limited to version specific parameters only.

² Typical TC programmed. The Temperature Coefficient is calculated using formula from section 8.

³ Final magnetic parameters will be covered in the PPAP documentation set, the table below is based on theoretical calculations.

⁴ Row “ $T_A = 125^\circ C$ ” is based on theoretical calculations only, not production tested.

MLX92292/MLX92291/MLX92271

3-wire μ Power programmable ASIL B capable Hall Effect Latch/Switch

Datasheet

8.24 MLX92271LSE-AAA-209-RE

DC Operating Parameters $V_{DD} = 3.3$ to $18V$, $T_A = -40^\circ C$ to $150^\circ C$

Test Condition	Operating Point B_{OP} (mT) ⁽³⁾			Release Point B_{RP} (mT) ⁽³⁾			TC (ppm/ $^\circ C$)	Output behaviour	Active Pole
	Min	Typ ⁽¹⁾	Max	Min	Typ ⁽¹⁾	Max	Typ ⁽¹⁾		
$T_A = -40^\circ C$	6.6	9.4	12.3	-12.3	-9.4	-6.6	-1100 ⁽²⁾	Latch	South pole
$T_A = 25^\circ C$	6.9	8.75	10.6	-10.6	-8.75	-6.9			
$T_A = 150^\circ C$	4.9	7.5	10.5	-10.5	-7.5	-4.9			

IMC	Safe message	Operating period, ms	Diagnostic period in Fail Safe state, ms	“Output Ticking” duration, μs	“Output Ticking” repetition period, ms
Yes	FNoDiag	-	-	-	-

¹ Unless otherwise specified the typical values are defined at $T_A = +25^\circ C$ and $V_{DD} = 12V$. Melexis production testing is limited to version specific parameters only.

² Typical TC programmed. The Temperature Coefficient is calculated using formula from section 8.

³ Final magnetic parameters will be covered in the PPAP documentation set, the table below is based on theoretical calculations.

MLX92292/MLX92291/MLX92271
3-wire μ Power programmable ASIL B capable Hall Effect Latch/Switch
Datasheet

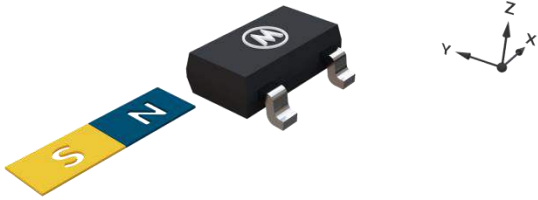

North active pole (IMC version)

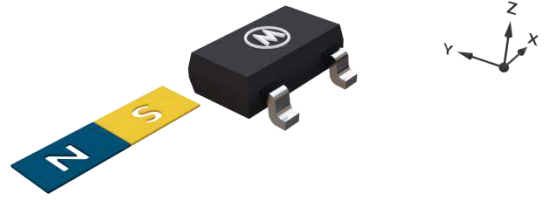

South active pole (IMC version)

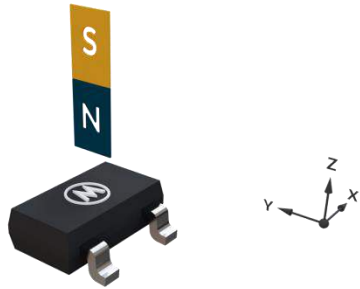

North active pole

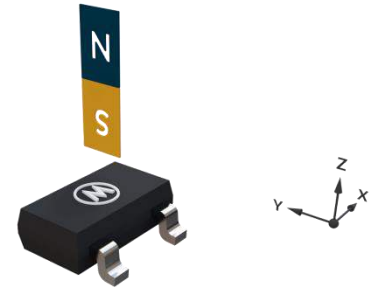

South active pole

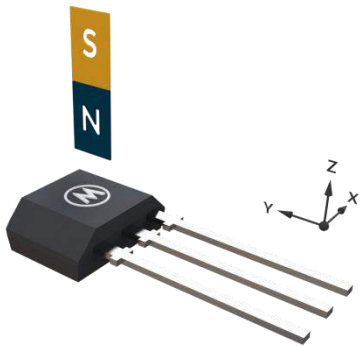

North active pole

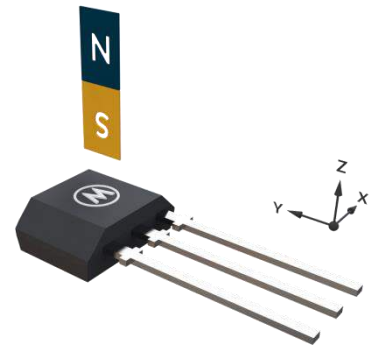

South active pole

9 Magnetic Behaviour

9.1 Latch Sensor

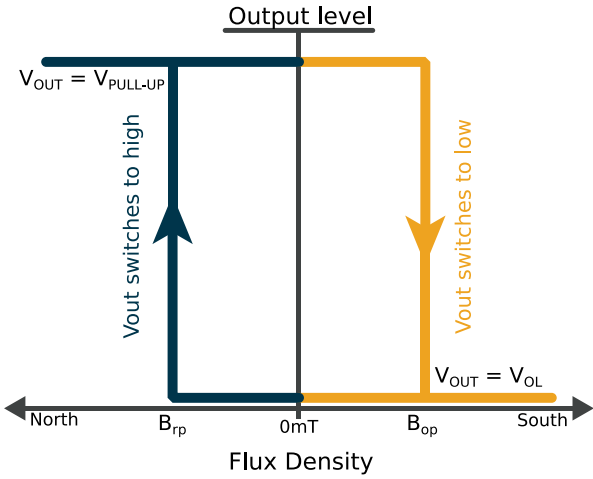

South Pole Active Latch

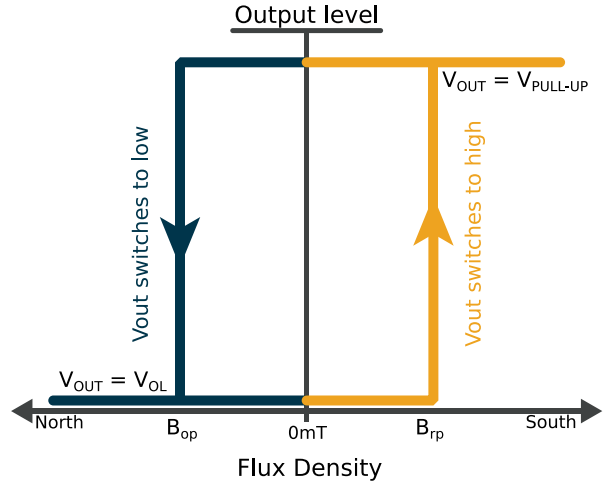

North Pole Active Latch

9.2 Unipolar Switch Sensor

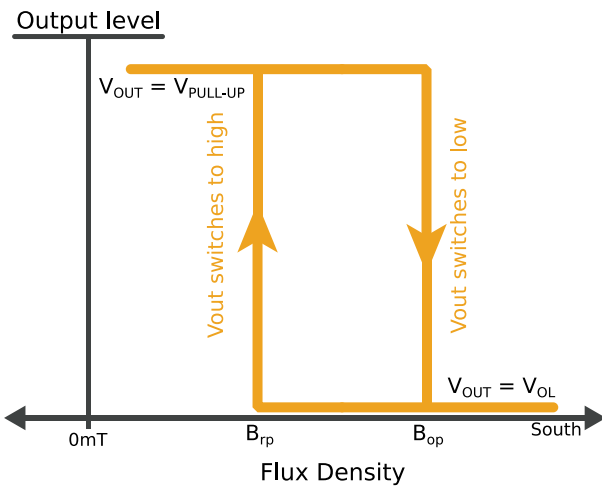

Direct South Pole Active Switch

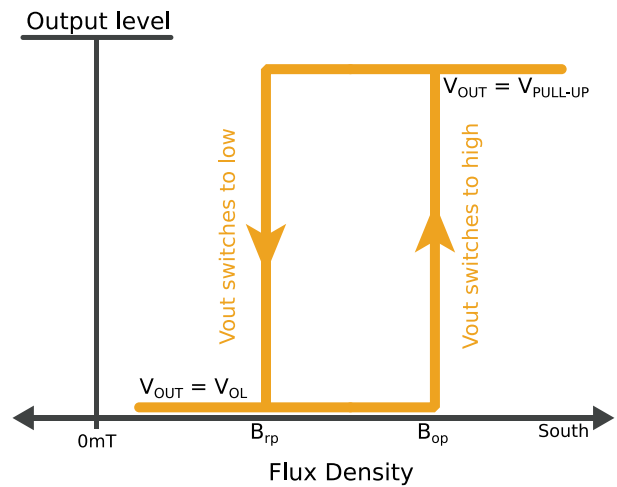

Inverted South Pole Active Switch

MLX92292/MLX92291/MLX92271

3-wire μ Power programmable ASIL B capable Hall Effect Latch/Switch

Datasheet

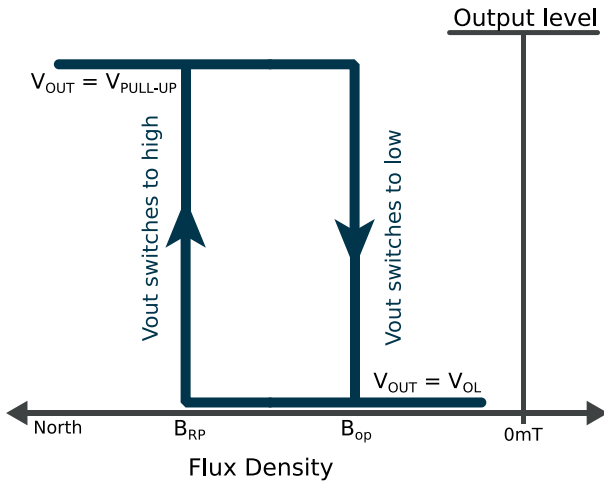

Direct North Pole Active Switch

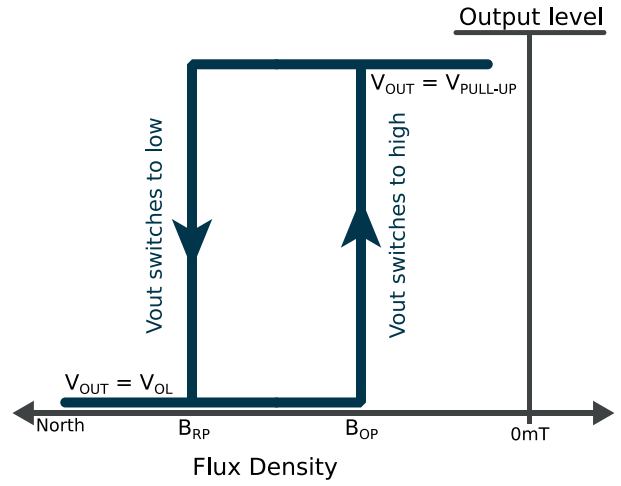

Inverted North Pole Active Switch

MLX92292/MLX92291/MLX92271

3-wire μ Power programmable ASIL B capable Hall Effect Latch/Switch
Datasheet

10 Functional Safety Capability

10.1 Sensor Development

MLX92292 is developed according to the ISO26262 requirements for ASIL B level.

10.2 Technical Safety Requirements

The main (mission) technical safety requirement for MLX92292 is the following:

10.2.1 TS_RQT_Mission

ASIL: B

MLX92292 shall not provide wrong information about the detection of presence of magnetic field done by comparing the magnetic field with magnetic thresholds B_{op} and B_{rp} , each of them being within a Safe Tolerance Interval (STI) defined in mT as $\pm a * B_{xp} \pm b$, where B_{xp} is the actual magnetic threshold (B_{op} or B_{rp}) and a , b are parameters depending on sensitivity direction and application temperature range. The following table shows the values of a and b for normal and lateral sensitivity device (with IMC) at 25°C and over the full temperature range.

	Ta = 25°C	Ta = -40°C..150°C
Normal (orthogonal) sensitive device	a = 0.18 (18%)	a = 0.22 (22%)
	b = 1.4mT	b = 1.7mT
Lateral sensitive device (with IMC)	a = 0.18 (18%)	a = 0.22 (22%)
	b = 2mT	b = 2.4mT

MLX92292/MLX92291/MLX92271

3-wire μ Power programmable ASIL B capable Hall Effect Latch/Switch

Datasheet



10.2.2 TS_RQT_Safe_Message

MLX92292 shall report detected failures that could prevent TS_RQT_Mission.

One of the following programmable Safe Message options can be chosen depending on the application:

Message Option	B<Brp Diagnostic OK	B>Bop Diagnostic OK	All B values Diagnostic Failed	Diagnostic Coverage	Safe States
μ-Power Mode				SPFM	
TickMsg ^(1,2)	OUT = Off+Ticking	OUT = On+Ticking	OUT = Off	92%	BOP, BRP within STI ; OUT = On/Off w/o ticking
TickOffMsg ⁽¹⁾	OUT = Off+Ticking	OUT = On	OUT = Off	82%	BOP, BRP within STI ; OUT = Off
TickOnMsg ⁽²⁾	OUT = Off	OUT = On+Ticking	OUT = On	55%	BOP, BRP within STI ; OUT = On
OutOffMsg	OUT = Off	OUT = On	OUT = Off	82%	BOP, BRP within STI ; OUT = Off
OutOnMsg	OUT = Off	OUT = On	OUT = On	55%	BOP, BRP within STI ; OUT = On
StbyX2Msg ⁽³⁾	OUT = Off	OUT = On	OUT = Off Twice increased T_{OP}	77%	BOP, BRP within STI ; Twice increased T_{OP}
uNoDiag ⁽⁴⁾	OUT = Off	OUT = On	-	No diagnostic	BOP, BRP within STI
Fast Mode					
FIddMsg	OUT = Off, IDD = IDDFAST	OUT = On, IDD = IDDFAST	OUT = Off, IDD = IDDFAIL	67%	BOP, BRP within STI ; OUT=Off & IDD=IDDFAIL
FNoDiag ⁽⁴⁾	OUT = Off	OUT = On	-	No diagnostic	BOP, BRP within STI

Note (1) Off+Ticking signal means that the Off state duration lasts significantly longer than the On state duration.

Note (2) On+Ticking signal means that the On state duration lasts significantly longer than the Off state duration.

Note (3) If T_{OP} is set <5ms then T_{OP} increases less than twice in case of diagnostic fail.

Note (4) This message option does not offer integrated diagnostic.

11 Application Information

11.1 Typical Automotive Application Circuit

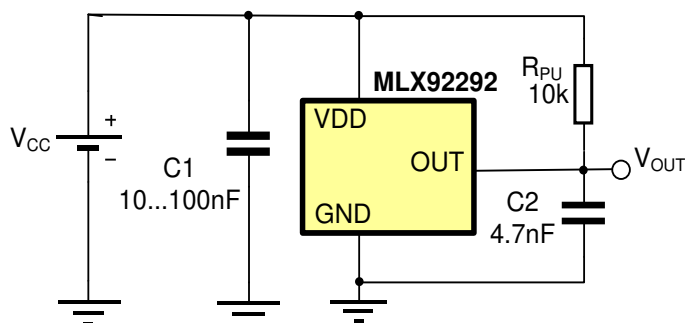

Notes:

1. For proper operation, a 10nF to 100nF bypass capacitor should be placed as close as possible to the V_{DD} and ground pin.

2. A capacitor connected to the output will improve the EMC performance

11.2 Automotive and Harsh, Noisy Environments Application Circuit

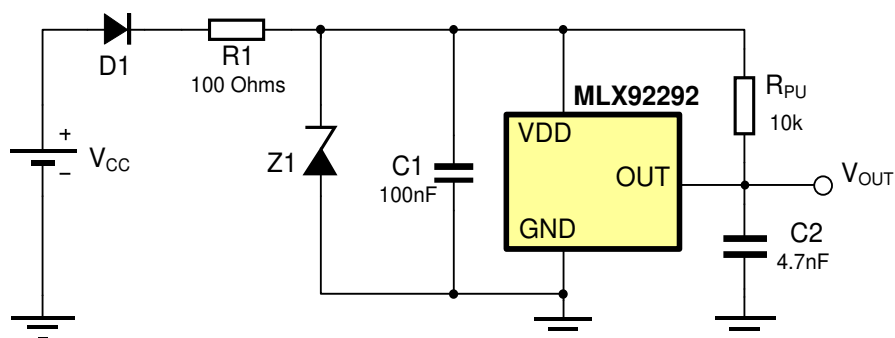

Notes:

1. For proper operation the bypass capacitor C1 should be placed as close as possible to the V_{DD} and GND pins.

2. If negative transients over supply line $V_{PEAK} < -30V$ are expected, usage of the diode D1 is recommended. Otherwise only R1 is sufficient.

When selecting the resistor R1, three points are important:

- the resistor has to limit I_{DD}/I_{DDREV} to 40mA maximum
- the resistor has to withstand the power dissipated in both over voltage conditions ($V_{R1}^2/R1$)
- the resulting device supply voltage V_{DD} has to be higher than $V_{DD\ min}$ ($V_{DD} = V_{CC} - R1 \cdot I_{DD}$)

3. If positive transients over supply line with $V_{PEAK} > 40V$ are expected, usage of Zener diode Z1 is recommended. The R1-Z1 network should be sized to limit the voltage over the device below the maximum allowed.

12 Package Information

12.1 TSOT-3L (SE Package)

12.1.1 TSOT-3L – Package dimensions

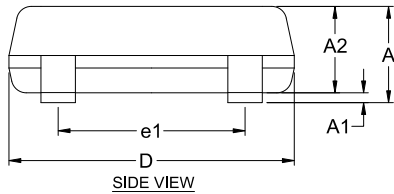
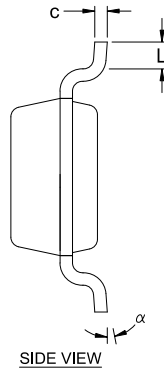
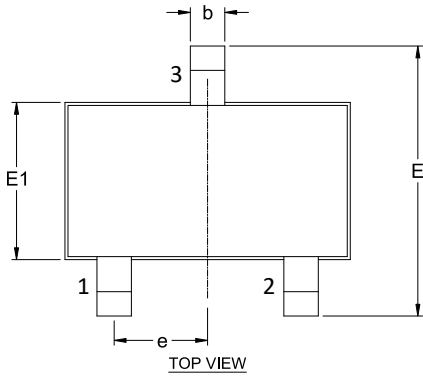

SYMBOL	MINIMUM	MAXIMUM
A	---	1.00
A1	0.025	0.10
A2	0.85	0.90
D	2.80	3.00
E	2.60	3.00
E1	1.50	1.70
L	0.30	0.50
b	0.30	0.45
c	0.10	0.20
e	0.95 BSC	
e1	1.90 BSC	
α	0°	8°

NOTE :

1. ALL DIMENSIONS IN MILLIMETERS (mm) UNLESS OTHERWISE STATED.
2. DIMENSION D DOES NOT INCLUDE MOLD FLASH OR PROTRUSIONS OF MAX 0.15 mm PER SIDE.
3. DIMENSION E DOES NOT INCLUDE MOLD FLASH OR PROTRUSIONS OF MAX 0.25 mm PER SIDE.
4. DIMENSION b DOES NOT INCLUDE DAMBAR PROTRUSION OF MAX 0.07 mm.
5. DIMENSION L IS THE LENGTH OF THE TERMINAL FOR SOLDERING TO A SUBSTRATE.
6. FORMED LEAD SHALL BE PLANAR WITH RESPECT TO ONE ANOTHER WITH 0.076 mm SEATING PLANE.

12.1.2 TSOT-3L – Sensitive spot

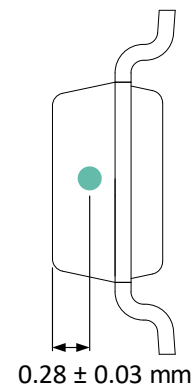
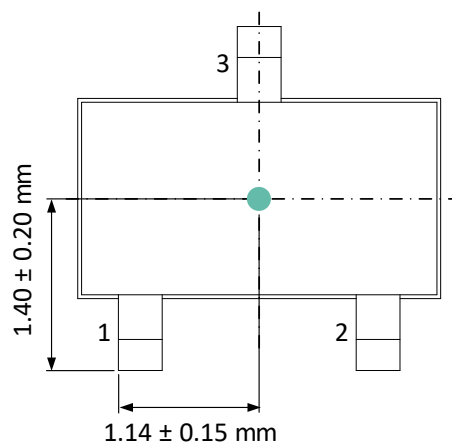
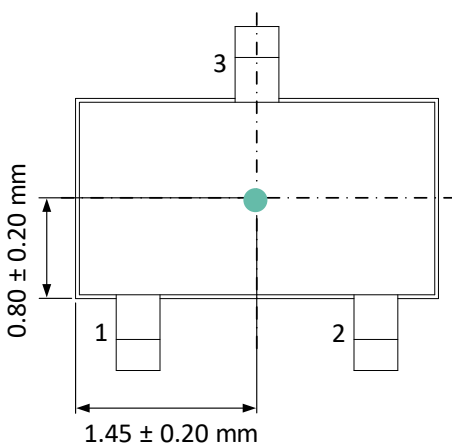

MLX92292/MLX92291/MLX92271

3-wire μ Power programmable ASIL B capable Hall Effect Latch/Switch

Datasheet

12.1.3 TSOT-3L – Package marking / Pin definition

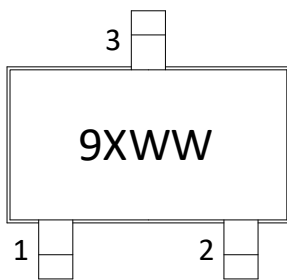

Top

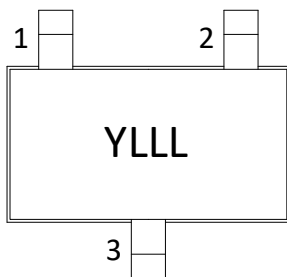
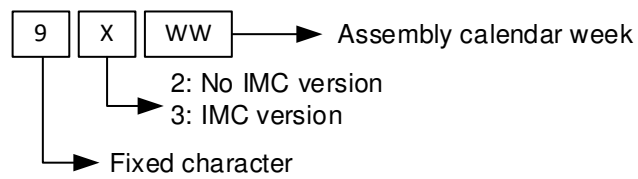

Bottom

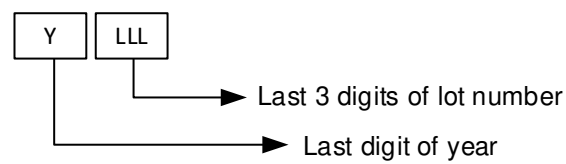

Pin #	Name	Type	Function
1	VDD	Supply	Supply Voltage pin
2	OUT	Out	Open drain output pin
3	GND	Ground	Ground pin

MLX92292/MLX92291/MLX92271

3-wire μ Power programmable ASIL B capable Hall Effect Latch/Switch

Datasheet

12.2 TO92-3L (UA Package)

12.2.1 TO92-3L – Package dimensions

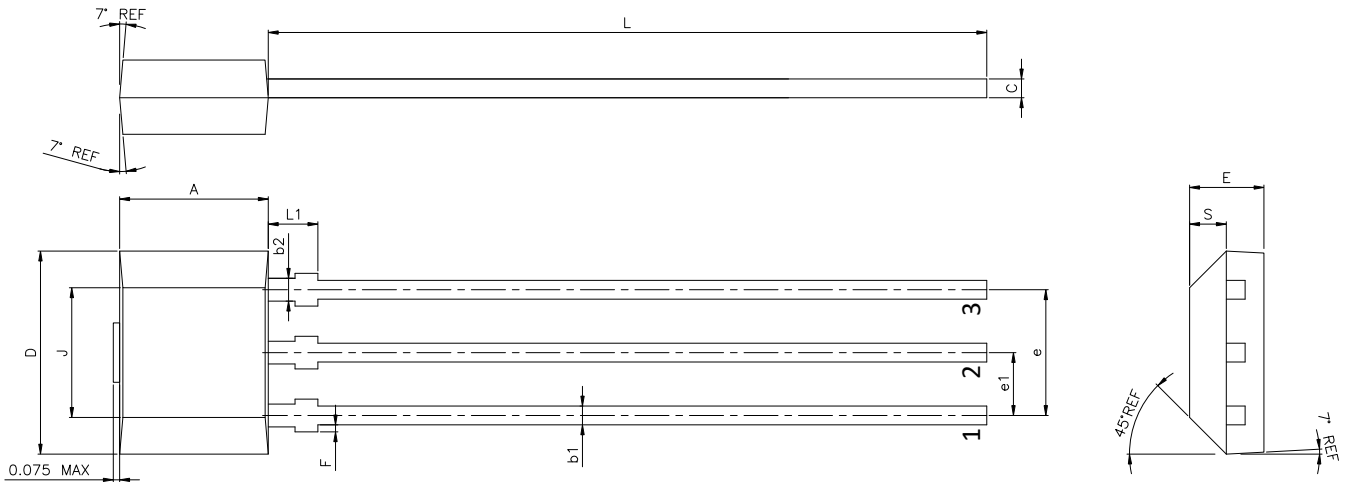

SYMBOL	MINIMUM	MAXIMUM
A	2.90	3.10
D	4.00	4.20
E	1.40	1.60
F	0.00	0.15
J	2.51	2.72
L	14.00	15.00
L1	0.90	1.10
S	0.63	0.84
b1	0.35	0.44
b2	0.43	0.52
c	0.35	0.44
e	2.51	2.57
e1	1.24	1.30

NOTES :

1. DIMENSIONS IN MILLIMETERS (mm) UNLESS NOTED OTHERWISE.
2. PACKAGE DIMENSIONS DO NOT INCLUDE MOLD FLASHES AND PROTRUSIONS.
3. DIMENSION A AND D DO NOT INCLUDE MOLD GATE AND SIDE FLASH (PROTRUSION) of MAXIMUM 0.127 mm PER SIDE.
4. THE LEADS MAY BE SLIGHTLY DEFORMED DURING TRANSPORTATION IF PACKED IN BULK (BAG), AFFECTING e1 DIMENSION. IT IS RECOMMENDED TO ORDER RADIAL TAPE (REEL OR AMMOPACK) IF SUCH DEFORMATION IS CRITICAL FOR THE LEAD FORMING PROCESS, EVEN IF MANUAL LOADING INTO THE TOOL IS FORESEEN.

12.2.2 TO92-3L – Sensitive spot

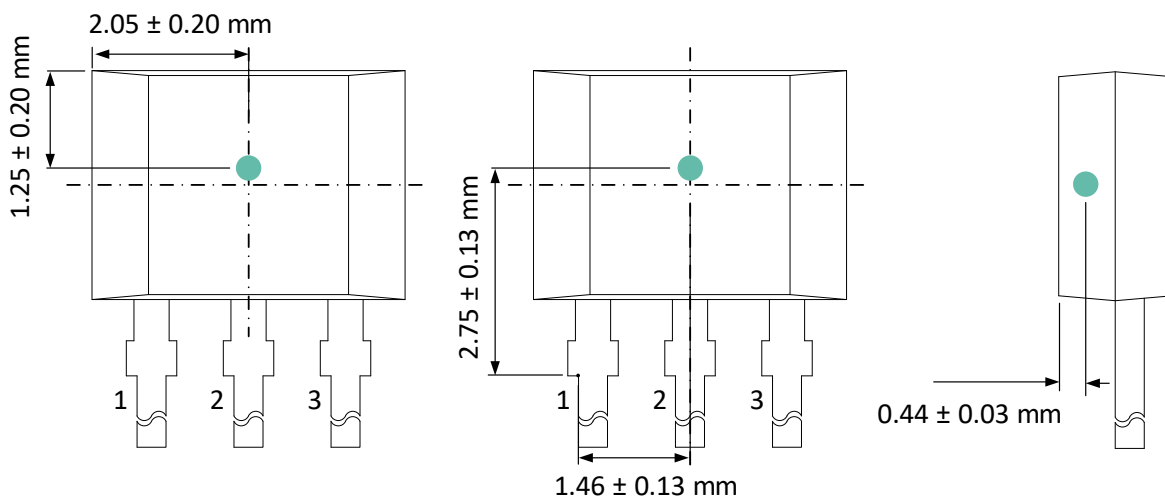

MLX92292/MLX92291/MLX92271

3-wire μ Power programmable ASIL B capable Hall Effect Latch/Switch
 Datasheet

12.2.3 TO92-3L – Package marking / Pin definition

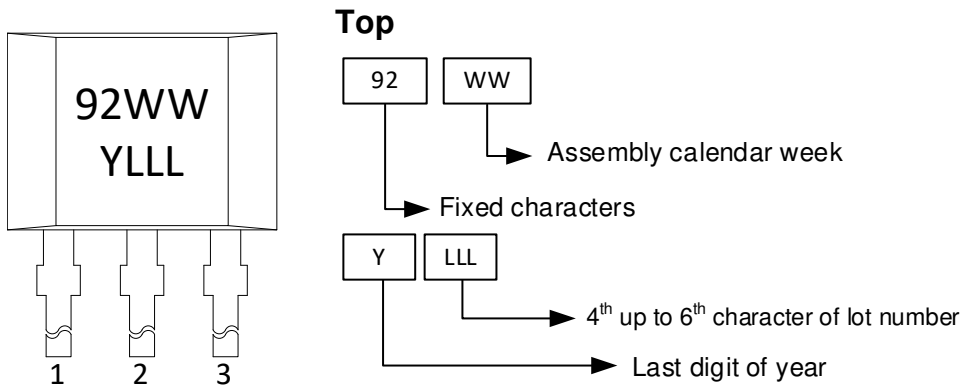

Pin #	Name	Type	Function
1	VDD	Supply	Supply Voltage pin
2	GND	Ground	Ground pin
3	OUT	Out	Open drain output pin

MLX92292/MLX92291/MLX92271

3-wire μ Power programmable ASIL B capable Hall Effect Latch/Switch

Datasheet

12.3 SOIC8 (DC Package)

12.3.1 SOIC8– Package dimensions

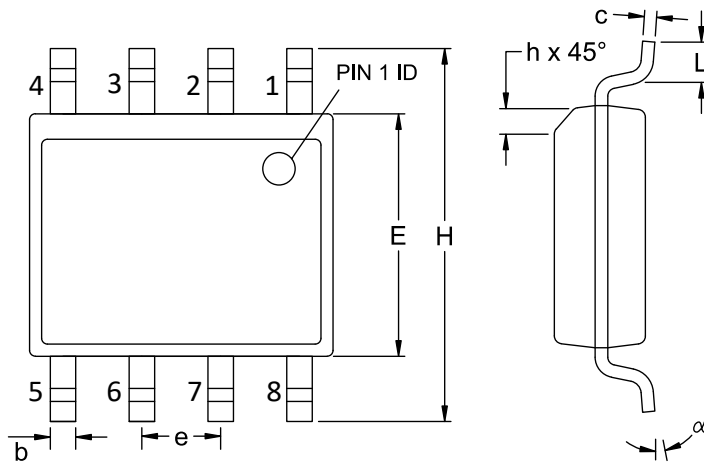

TOP VIEW

SIDE VIEW

SYMBOL	MINIMUM	MAXIMUM
A	1.52	1.73
A1	0.10	0.25
A2	1.37	1.57
D	4.80	4.98
E	3.81	3.99
H	5.80	6.20
L	0.41	1.27
b	0.35	0.49
c	0.19	0.25
h	0.25	0.50
e	1.27 BSC	
α	0°	8°

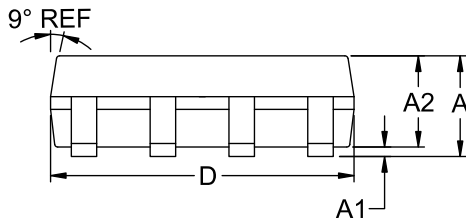

SIDE VIEW

NOTE :

1. ALL DIMENSIONS IN MILLIMETERS (mm) UNLESS OTHERWISE STATED.
2. DIMENSION D DOES NOT INCLUDE MOLD FLASH, PROTRUSIONS OR GATE BURRS OF MAX 0.15 mm PER SIDE.
3. DIMENSION E DOES NOT INCLUDE INTERLEADS FLASH OR PROTRUSIONS OF MAX 0.25 mm PER SIDE.
4. DIMENSION b DOES NOT INCLUDE DAMBAR PROTRUSION OF MAX 0.08 mm.

MLX92292/MLX92291/MLX92271

3-wire μ Power programmable ASIL B capable Hall Effect Latch/Switch

Datasheet

12.3.2 SOIC8– Sensitive spot

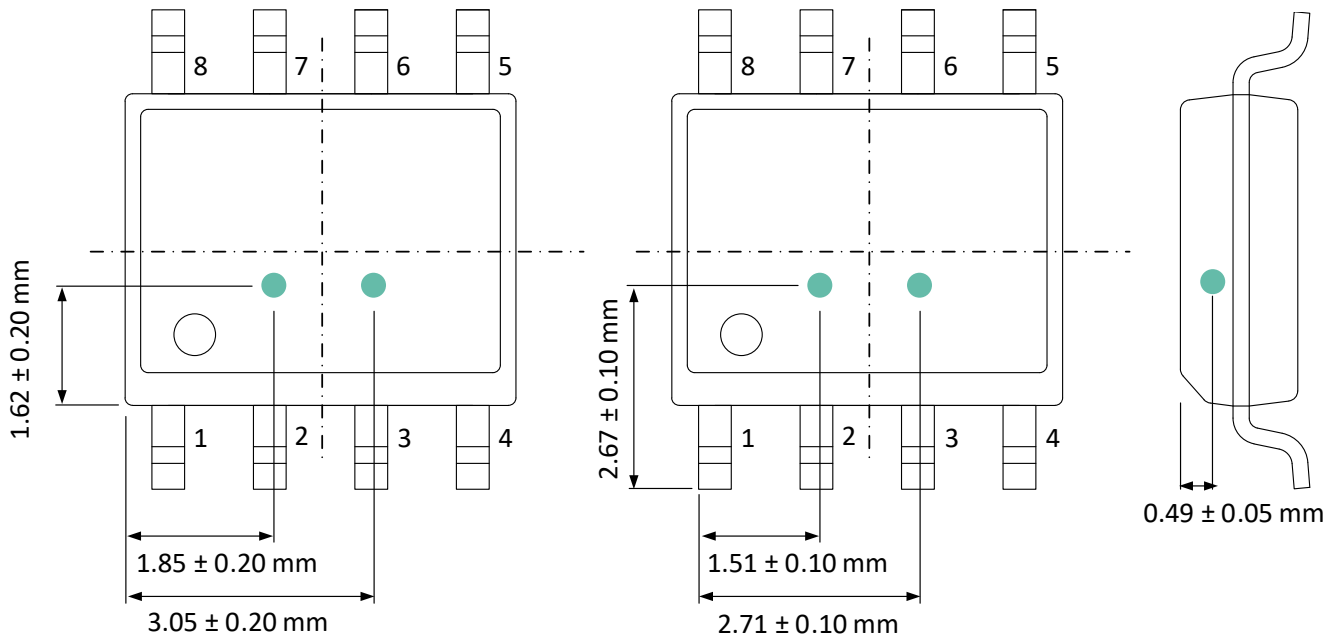

MLX92292/MLX92291/MLX92271

3-wire μ Power programmable ASIL B capable Hall Effect Latch/Switch

Datasheet

12.3.3 SOIC8– Package marking / Pin definition

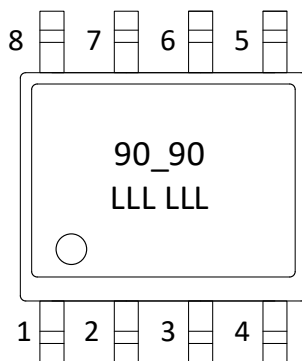

Marking

Top side

90_90 → Device name

LLL LLL → Last 3 digits of assembly lot# from each die

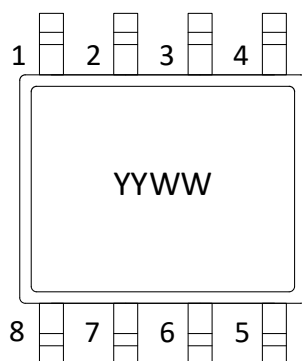

Bottom side

YY WW → Calender week (WW)

YY WW → Calender Year (YY)

Pin #	Name	Type	Function
1	GND2	Ground	Ground pin DIE 2
2	OUT2	Output	Output DIE 2
3	N.C.		Not connected
4	OUT1	Output	Output DIE 1
5	GND1	Ground	Ground DIE 1
6	VDD1	Supply	Supply DIE 1
7	N.C.		Not connected
8	VDD2	Supply	Supply DIE 2

13 Standard information regarding manufacturability

Our products are classified and qualified regarding soldering technology, solderability and moisture sensitivity level according to following test methods:

Reflow Soldering SMD's (Surface Mount Devices)

- IPC/JEDEC J-STD-020
Moisture/Reflow Sensitivity Classification for Nonhermetic Solid State Surface Mount Devices (classification reflow profiles according to table 5-2)
- EIA/JEDEC JESD22-A113
Preconditioning of Nonhermetic Surface Mount Devices Prior to Reliability Testing (reflow profiles according to table 2)

Wave Soldering SMD's (Surface Mount Devices) and THD's (Through Hole Devices)

- EN60749-20
Resistance of plastic-encapsulated SMD's to combined effect of moisture and soldering heat
- EIA/JEDEC JESD22-B106 and EN60749-15
Resistance to soldering temperature for through-hole mounted devices

Iron Soldering THD's (Through Hole Devices)

- EN60749-15
Resistance to soldering temperature for through-hole mounted devices

Solderability SMD's (Surface Mount Devices) and THD's (Through Hole Devices)

- EIA/JEDEC JESD22-B102 and EN60749-21
Solderability

For all soldering technologies deviating from above mentioned standard conditions (regarding peak temperature, temperature gradient, temperature profile etc) additional classification and qualification tests have to be agreed upon with Melexis.

The application of Wave Soldering for SMD's is allowed only after consulting Melexis regarding assurance of adhesive strength between device and board.

Melexis is contributing to global environmental conservation by promoting **lead free** solutions. For more information on qualifications of **RoHS** compliant products (RoHS = European directive on the Restriction Of the use of certain Hazardous Substances) please visit the quality page on our website: <http://www.melexis.com/quality.aspx>

14 ESD Precautions

Electronic semiconductor products are sensitive to Electro Static Discharge (ESD).

Always observe Electro Static Discharge control procedures whenever handling semiconductor products.

For the latest version of this document, go to our website at www.melexis.com.

For additional information, please contact our Direct Sales team and get help for your specific needs:

Europe, Africa	Telephone: +32 13 67 04 95
	Email : sales_europe@melexis.com
Americas	Telephone: +1 603 223 2362
	Email : sales_usa@melexis.com
Asia	Email : sales_asia@melexis.com

16 Disclaimer

The content of this document is believed to be correct and accurate. However, the content of this document is furnished "as is" for informational use only and no representation, nor warranty is provided by Melexis about its accuracy, nor about the results of its implementation. Melexis assumes no responsibility or liability for any errors or inaccuracies that may appear in this document. Customer will follow the practices contained in this document under its sole responsibility. This documentation is in fact provided without warranty, term, or condition of any kind, either implied or expressed, including but not limited to warranties of merchantability, satisfactory quality, non-infringement, and fitness for purpose. Melexis, its employees and agents and its affiliates' and their employees and agents will not be responsible for any loss, however arising, from the use of, or reliance on this document. Notwithstanding the foregoing, contractual obligations expressly undertaken in writing by Melexis prevail over this disclaimer.

This document is subject to change without notice, and should not be construed as a commitment by Melexis. Therefore, before placing orders or prior to designing the product into a system, users or any third party should obtain the latest version of the relevant information. Users or any third party must determine the suitability of the product described in this document for its application, including the level of reliability required and determine whether it is fit for a particular purpose.

This document as well as the product here described may be subject to export control regulations. Be aware that export might require a prior authorization from competent authorities. The product is not designed, authorized or warranted to be suitable in applications requiring extended temperature range and/or unusual environmental requirements. High reliability applications, such as medical life-support or life-sustaining equipment or avionics application are specifically excluded by Melexis. The product may not be used for the following applications subject to export control regulations: the development, production, processing, operation, maintenance, storage, recognition or proliferation of:

- 1. chemical, biological or nuclear weapons, or for the development, production, maintenance or storage of missiles for such weapons;*
- 2. civil firearms, including spare parts or ammunition for such arms;*
- 3. defense related products, or other material for military use or for law enforcement;*
- 4. any applications that, alone or in combination with other goods, substances or organisms could cause serious harm to persons or goods and that can be used as a means of violence in an armed conflict or any similar violent situation.*

No license nor any other right or interest is granted to any of Melexis' or third party's intellectual property rights.

If this document is marked "restricted" or with similar words, or if in any case the content of this document is to be reasonably understood as being confidential, the recipient of this document shall not communicate, nor disclose to any third party, any part of the document without Melexis' express written consent. The recipient shall take all necessary measures to apply and preserve the confidential character of the document. In particular, the recipient shall (i) hold document in confidence with at least the same degree of care by which it maintains the confidentiality of its own proprietary and confidential information, but no less than reasonable care; (ii) restrict the disclosure of the document solely to its employees for the purpose for which this document was received, on a strictly need to know basis and providing that such persons to whom the document is disclosed are bound by confidentiality terms substantially similar to those in this disclaimer; (iii) use the document only in connection with the purpose for which this document was received, and reproduce document only to the extent necessary for such purposes; (iv) not use the document for commercial purposes or to the detriment of Melexis or its customers. The confidentiality obligations set forth in this disclaimer will have indefinite duration and in any case they will be effective for no less than 10 years from the receipt of this document.

This disclaimer will be governed by and construed in accordance with Belgian law and any disputes relating to this disclaimer will be subject to the exclusive jurisdiction of the courts of Brussels, Belgium.

The invalidity or ineffectiveness of any of the provisions of this disclaimer does not affect the validity or effectiveness of the other provisions. The previous versions of this document are repealed.

Melexis © - No part of this document may be reproduced without the prior written consent of Melexis. (2021)

IATF 16949 and ISO 14001 Certified