

Description

The DIODES™ AP7387Q series is a wide input voltage range (60V), low quiescent current, high PSRR linear regulator able to driver 150mA output current.

The AP7387Q features a very fast line/load transient response against the rapid input voltage and load current changes. The IC consists of a voltage reference, an error amplifier, a resistor network for setting output voltage, a current limit circuit for current protection, short-circuit and thermal shutdown protection.

The AP7387Q has 3.0V, 3.3V, 3.6V, and 5V fixed output voltage versions, and is available in the SOT89 and U-DFN2020-6 (SWP) (Type UXC) packages.

Features

- Wide Input Voltage Range: 5V to 60V
- Maximum Output Current: 150mA
- Dropout Voltage:
 $V_{DRO} = 700\text{mV} @ I_{OUT} = 100\text{mA (Typ.)}$
 $V_{DRO} = 1100\text{mV} @ I_{OUT} = 150\text{mA (Typ.)}$
- Low Quiescent Current: 2 μA (Typ.)
- High Output Voltage Accuracy: $\pm 2\%$
- High PSRR: 70dB @1kHz
- Excellent Line/Load Regulation
- Thermal Shutdown Function
- Short Current Protection Function
- Output Current Limit
- **Totally Lead-Free & Fully RoHS Compliant (Notes 1 & 2)**
- **Halogen- and Antimony-Free. "Green" Device (Note 3)**
- **The AP7387Q is suitable for automotive applications requiring specific change control; this part is AEC-Q100 qualified, PPAP capable, and manufactured in IATF 16949 certified facilities.**

<https://www.diodes.com/quality/product-definitions/>

- Notes:
1. No purposely added lead. Fully EU Directive 2002/95/EC (RoHS), 2011/65/EU (RoHS 2) & 2015/863/EU (RoHS 3) compliant.
 2. See <https://www.diodes.com/quality/lead-free/> for more information about Diodes Incorporated's definitions of Halogen- and Antimony-free, "Green" and Lead-free.
 3. Halogen- and Antimony-free "Green" products are defined as those which contain <900ppm bromine, <900ppm chlorine (<1500ppm total Br + Cl) and <1000ppm antimony compounds.

Pin Assignments

(Top View)

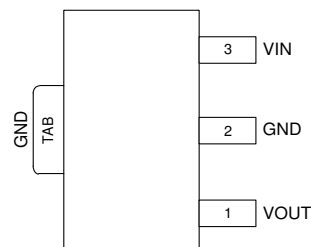

SOT89

(Top View)

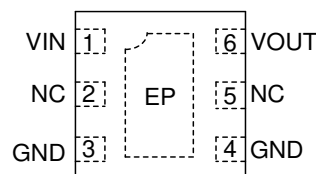

U-DFN2020-6 (SWP) (Type UXC)

Future Product

Applications

- Powering MCUs and CAN/LIN transceivers
- Automotive head units
- EV and HEV battery management systems
- Body control modules
- Transmission control units (TCUs)

Typical Applications Circuit

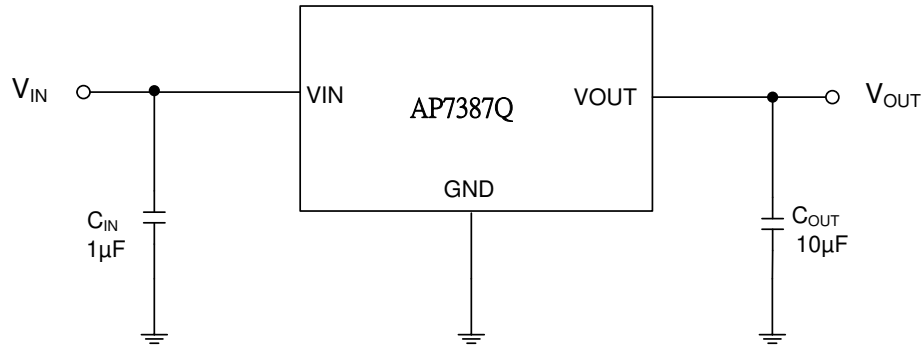

Pin Descriptions

Pin Number		Pin Name	Function
SOT89	U-DFN2020-6 (SWP) (Type UXC)		
3	1	VIN	Input voltage
2, TAB	3, 4	GND	Ground
—	2, 5	NC	Not connected internally, recommend connection to GND to maximize PCB copper for thermal dissipation.
1	6	VOUT	Regulated output voltage
—	EP	Exposed Pad	In PCB layout, prefer to use large copper area to cover this pad for better thermal dissipation, then connect this area to GND or leave it open. However, do not use it as GND electrode function alone.

Functional Block Diagram

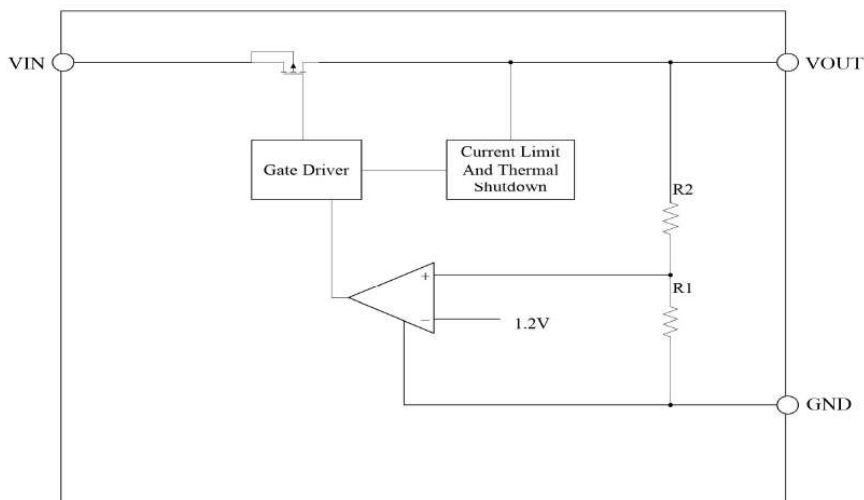

Absolute Maximum Ratings (Note 4) (@ $T_A = -40^{\circ}\text{C}$ to $+125^{\circ}\text{C}$, unless otherwise specified.)

Symbol	Parameter	Rating	Unit	
V_{IN}	Supply Input Voltage	-0.3 to 80	V	
V_{OUT}	Regulated Output Voltage	-0.3 to 6	V	
V_{OUT_VIN}	V_{OUT} to V_{IN}	-35 to 0.3	V	
I_{OUT}	Output Current	Internally Limited	mA	
T_{LEAD}	Lead Temperature (Soldering, 10sec)	+260	$^{\circ}\text{C}$	
T_J	Operating Junction Temperature	+150	$^{\circ}\text{C}$	
T_A	Operating Ambient Temperature	-40 to +125	$^{\circ}\text{C}$	
θ_{JA}	Thermal Resistance Junction to Ambient (θ_{JA})	SOT89	78.6	$^{\circ}\text{C}/\text{W}$
		U-DFN2020-6 (SWP) (Type UXC)	47.9	
T_{STG}	Storage Temperature Range	-40 to +150	$^{\circ}\text{C}$	
CDM	ESD (Change Device Model)	1.5	kV	
HBM	ESD (Human Body Model)	4	kV	

Note: 4. a). Stresses greater than those listed under *Absolute Maximum Ratings* can cause permanent damage to the device. These are stress ratings only, and functional operation of the device at these or any other conditions beyond those indicated under *Recommended Operating Conditions* is not implied. Exposure to *Absolute Maximum Ratings* for extended periods can affect device reliability.
 b). Ratings apply to ambient temperature at $+25^{\circ}\text{C}$. The JEDEC STD.51 High-K board design used to derive this data was a 3 inch x 3 inch multilayer board with 1oz. internal power and ground planes and 2oz. copper traces on the top and bottom of the board.

Recommended Operating Conditions

Symbol	Parameter	Min	Typ	Max	Unit
V_{IN}	Supply Input Voltage	5.0	—	60	V
V_{OUT}	Supply Output Voltage	3.0	—	5	V
T_J	Operating Junction Temperature	-40	—	+125	$^{\circ}\text{C}$
C_{IN}	Input Capacitor	—	1	—	μF
C_{OUT}	Output Capacitor	1	10	—	μF

Electrical Characteristics ($T_A = -40^{\circ}\text{C}$ to $+125^{\circ}\text{C}$, $I_{OUT} = 1\text{mA}$, $C_{IN} = 1\mu\text{F}$, $C_{OUT} = 10\mu\text{F}$ ceramic capacitor, $V_{IN} = V_{OUTNOM} + 2.0\text{V}$)

Symbol	Parameter	Test Conditions	Min	Typ	Max	Unit
V_{IN}	Input Voltage	—	5.0	—	60	V
I_{GND}	Quiescent Current	$V_{IN} = 12\text{V}$, No Load	—	2	5	μA
V_{OUT}	Output Voltage	$V_{IN} = 12\text{V}$, $I_{OUT} = 10\text{mA}$	$V_{OUT} \times 98\%$	—	$V_{OUT} \times 102\%$	V
I_{OUT_MAX}	—	—	—	150	—	mA
V_{DROP}	Dropout Voltage	$I_{OUT} = 50\text{mA}$, $V_{OUT} = V_{OUTNOM} - 0.1\text{V}$	—	350	500	mV
		$I_{OUT} = 100\text{mA}$, $V_{OUT} = V_{OUTNOM} - 0.1\text{V}$	—	700	1000	mV
		$I_{OUT} = 150\text{mA}$, $V_{OUT} = V_{OUTNOM} - 0.1\text{V}$	—	1100	1600	mV
$\Delta V_{OUT}(\Delta I_{OUT})$	Load Regulation	$V_{IN} = 12\text{V}$, $1\text{mA} \leq I_{OUT} \leq 150\text{mA}$	—	0.02	0.03	%/mA
$\Delta V_{OUT}/\Delta V_{IN}$	Line Regulation	$V_{OUTNOM} + 0.5\text{V} \leq V_{IN} \leq 60\text{V}$ $I_{OUT} = 1\text{mA}$	—	0.01	0.02	%/V
I_{LIMIT}	Current Limit	—	—	250	—	mA
T_{OTSD}	Thermal Shutdown Temperature	—	—	+150	—	$^{\circ}\text{C}$
T_{HYOTSD}	Thermal Shutdown Hysteresis	—	—	+30	—	$^{\circ}\text{C}$
PSRR	Power Supply Rejection Ratio	$V_{IN} = 12\text{V}$, $I_{OUT} = 1\text{mA}$ $V_{OUT} = 3.3\text{V}$ @1kHz	—	70	—	dB
θ_{JC}	Thermal Resistance Junction to Case (θ_{JC})	SOT89	—	25.1	—	$^{\circ}\text{C}/\text{W}$
		U-DFN2020-6 (SWP) (Type UXC)	—	15.5	—	

Performance Characteristics

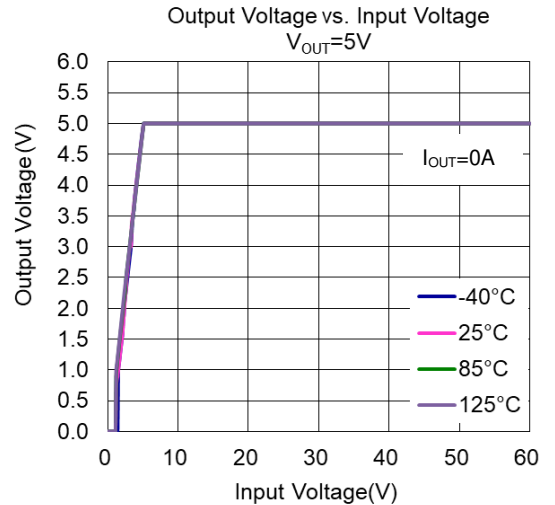
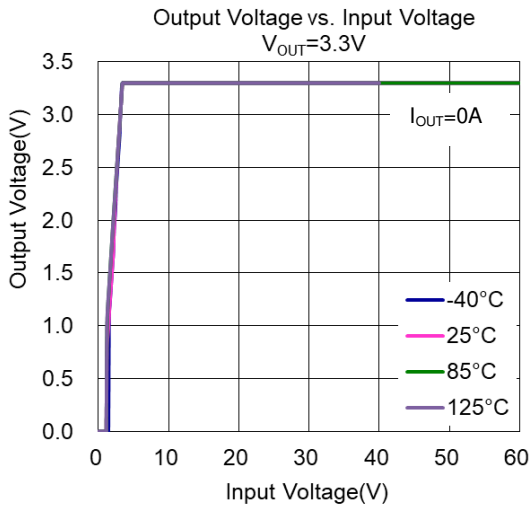
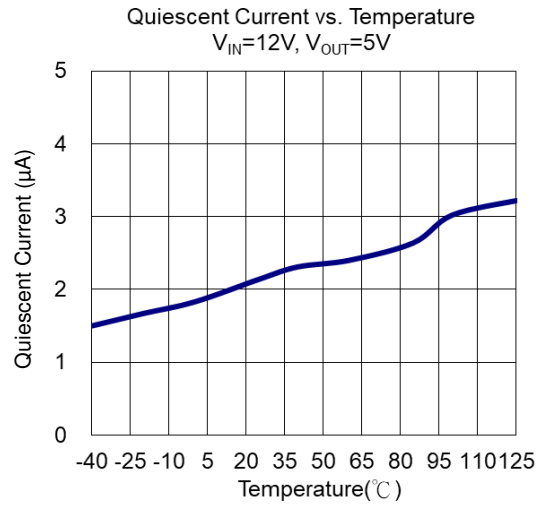
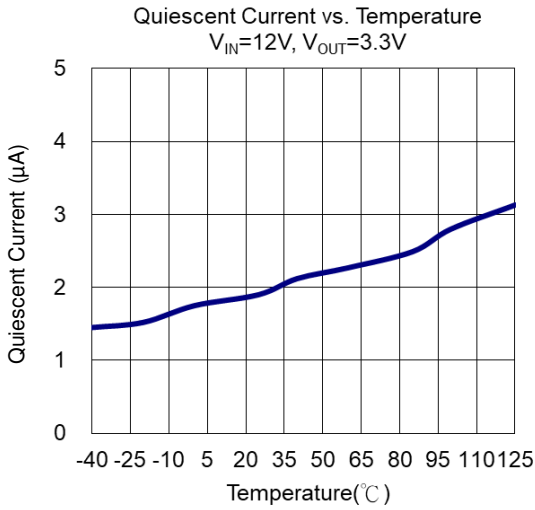
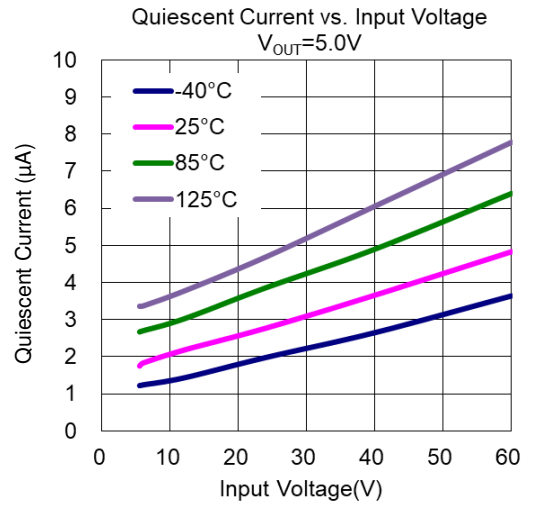
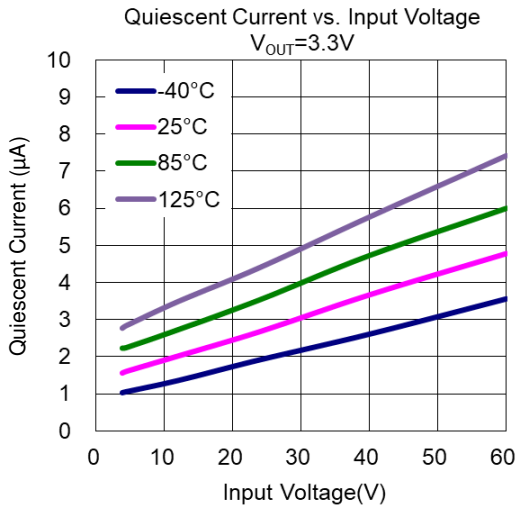

Typical Characteristics

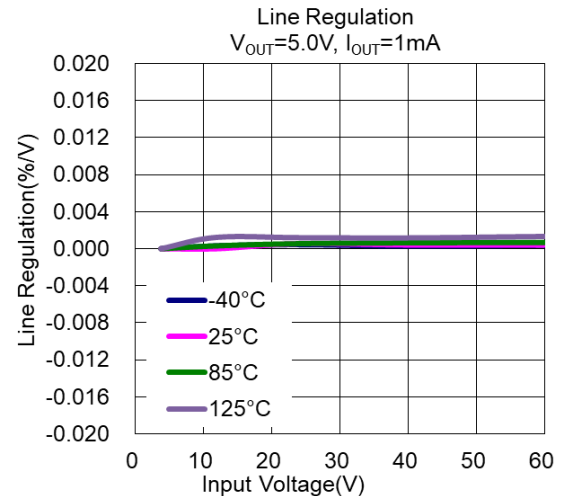
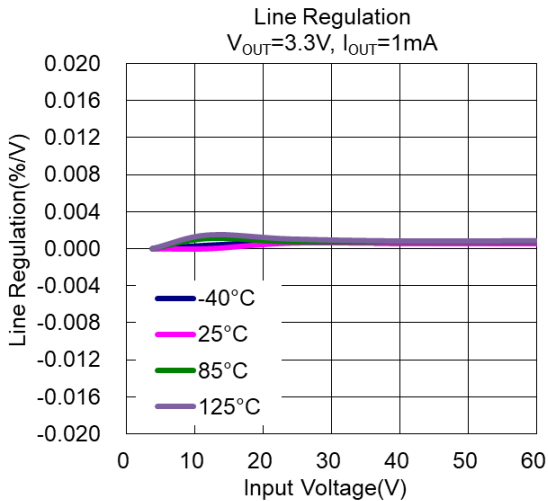
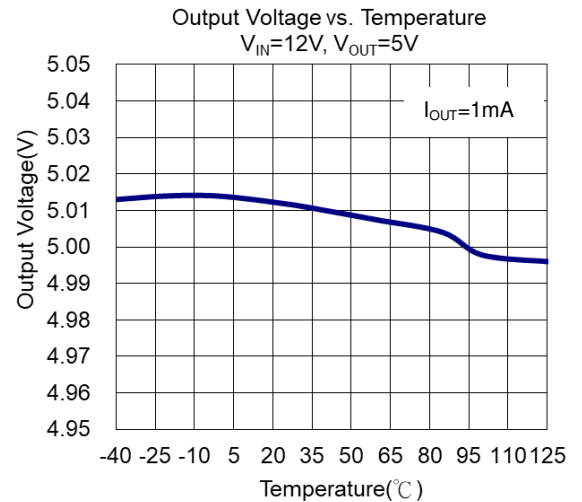
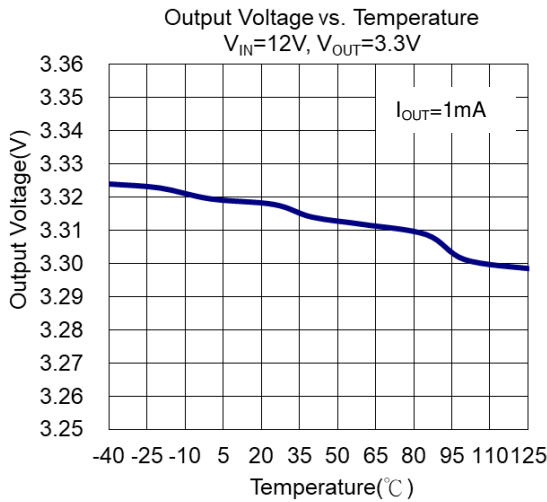
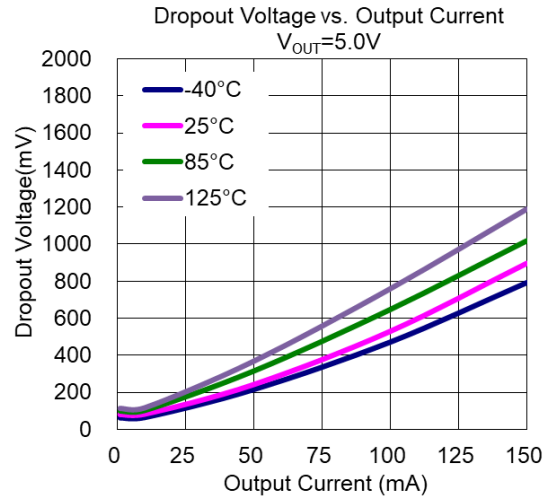
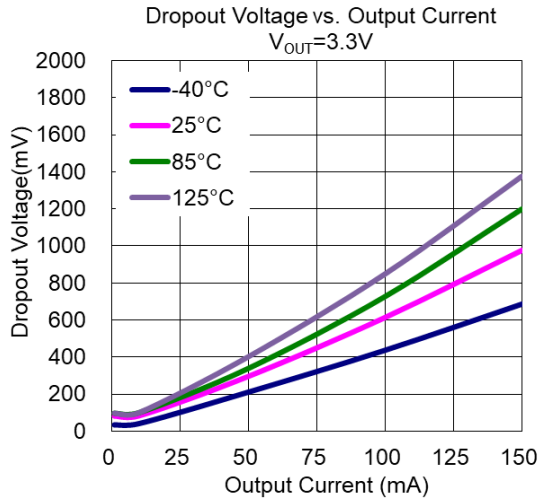

Typical Characteristics (continued)

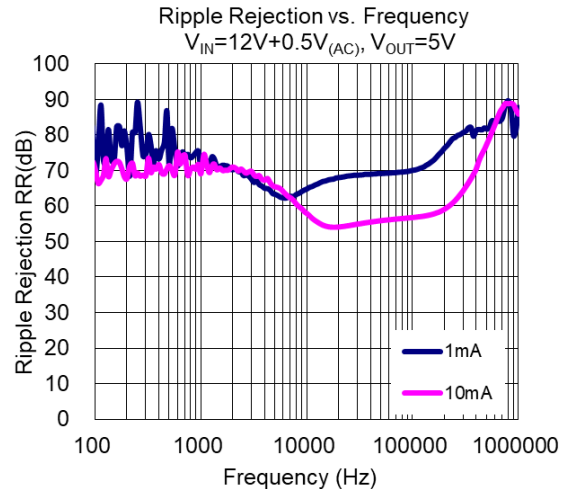
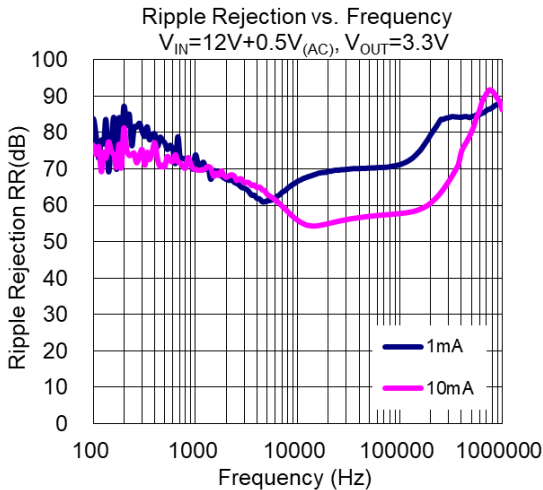
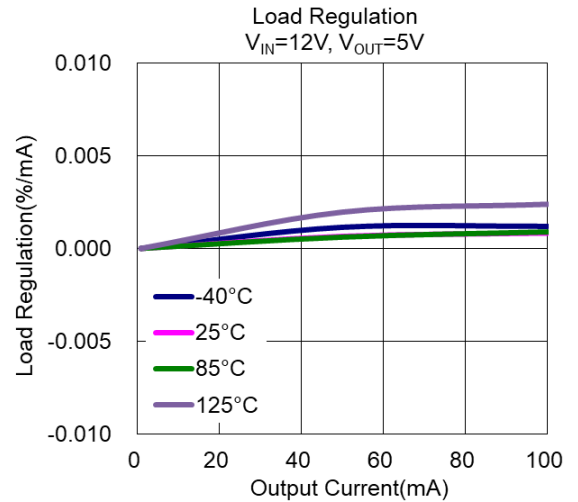
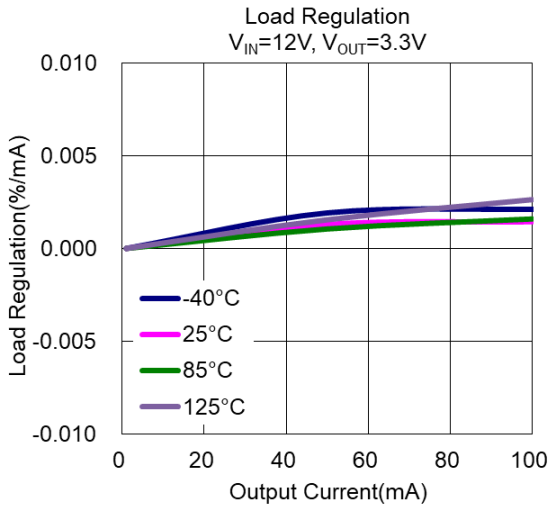
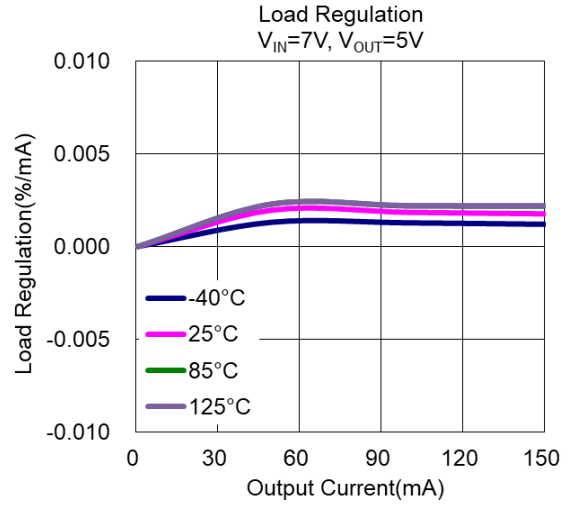
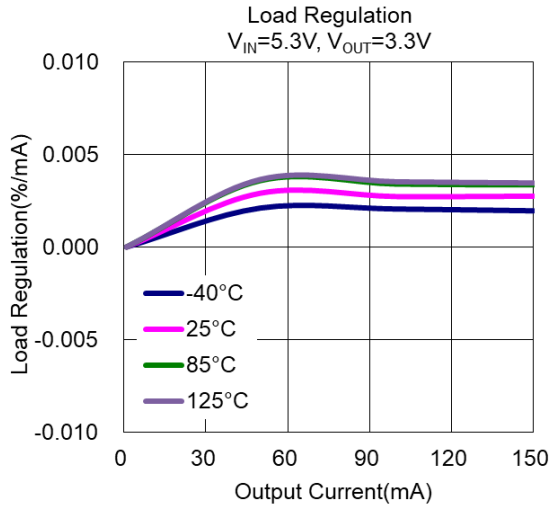

Typical Characteristics (continued)

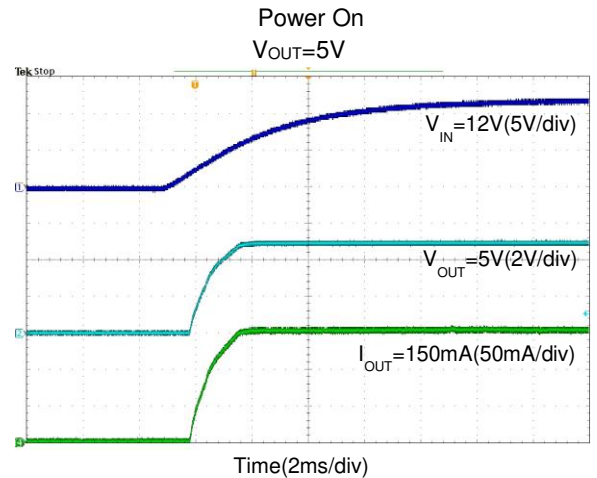
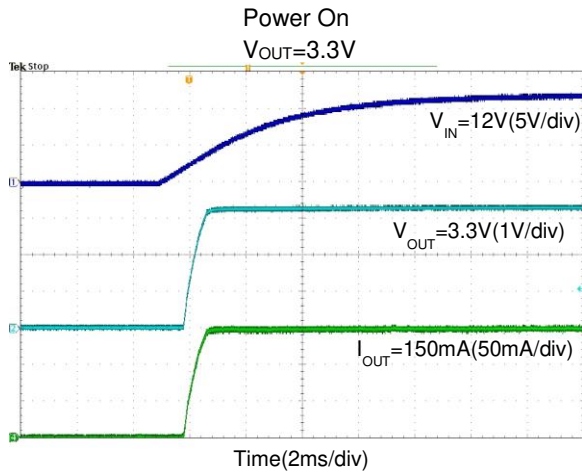
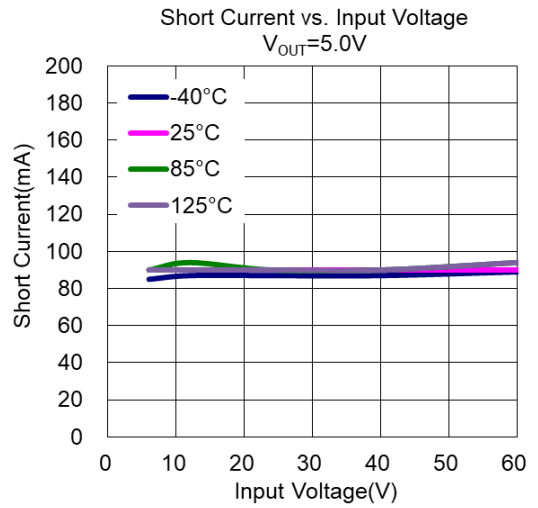
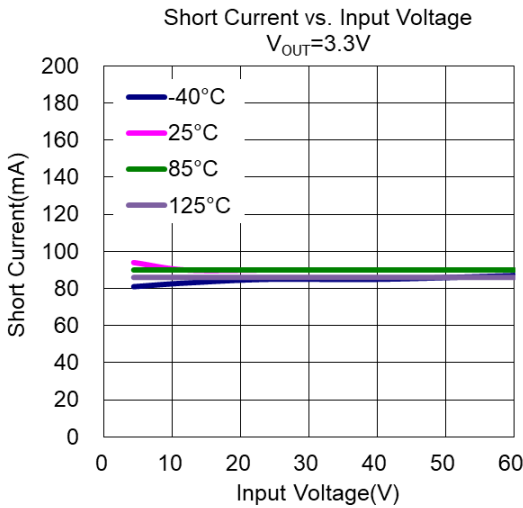
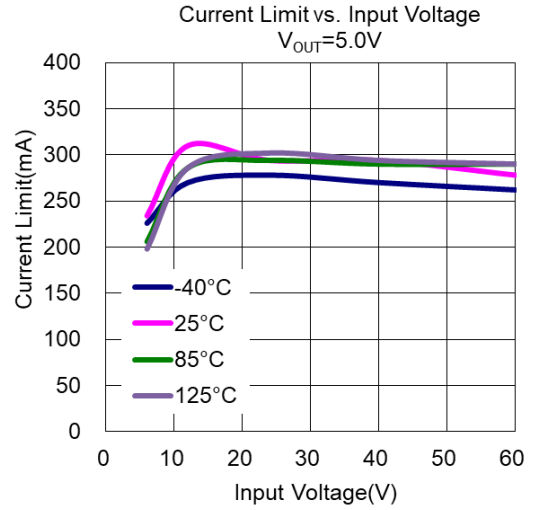
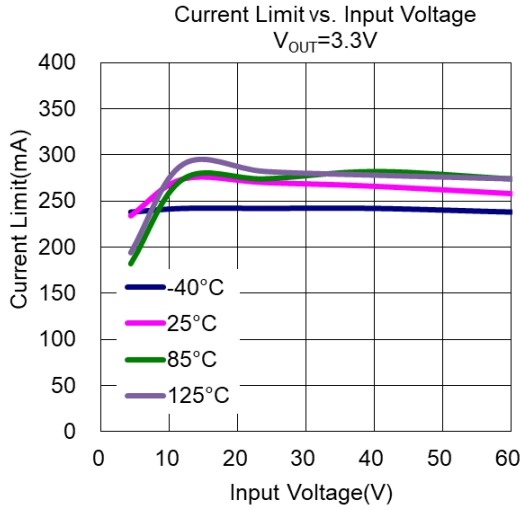

Typical Characteristics (continued)

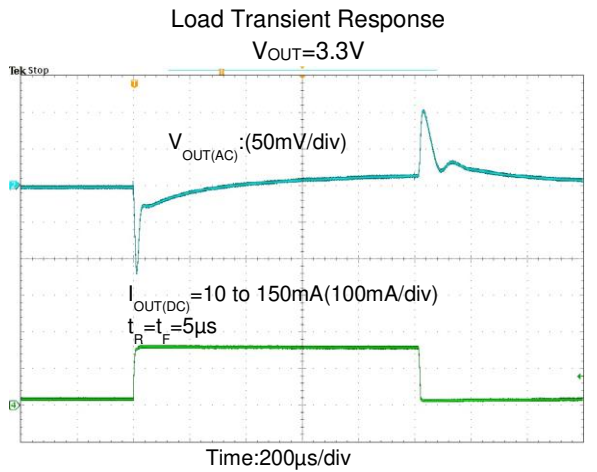
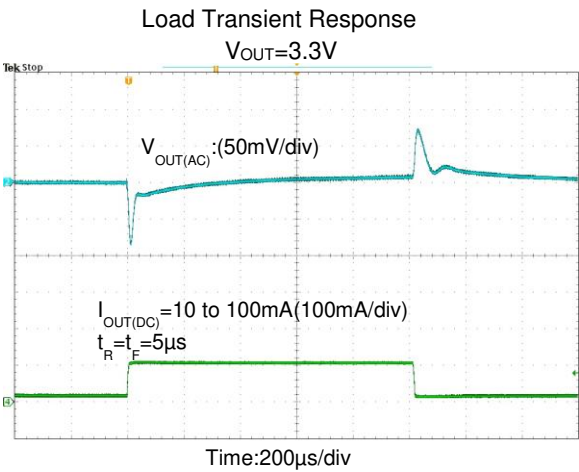
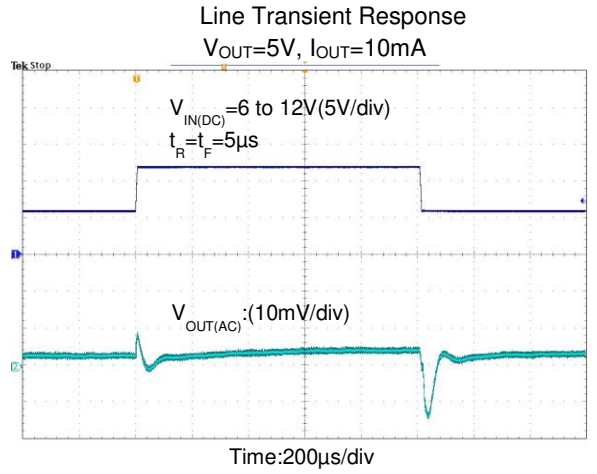
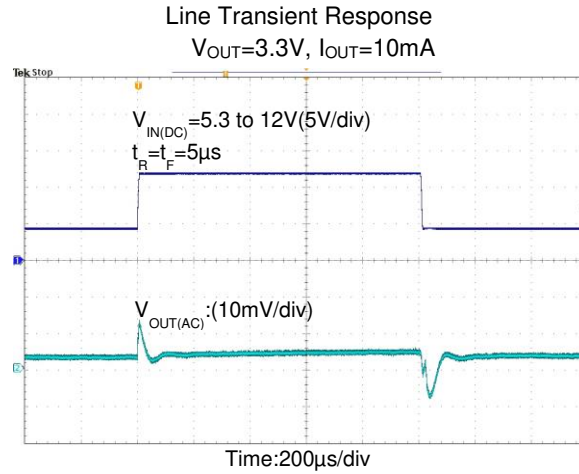
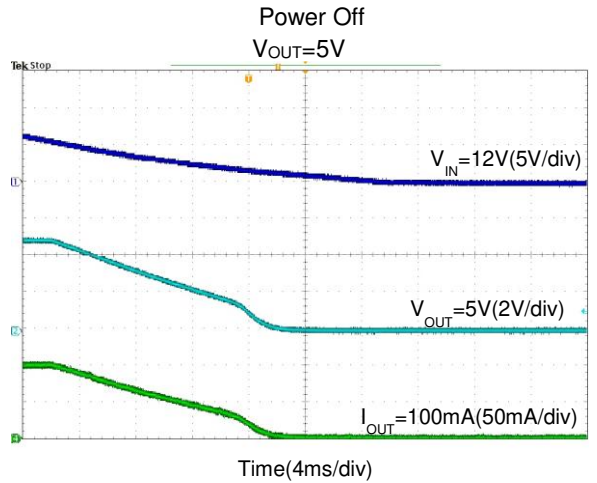
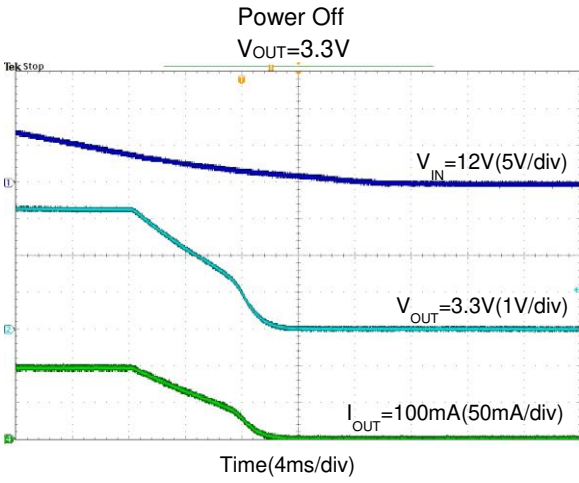

Typical Characteristics (continued)

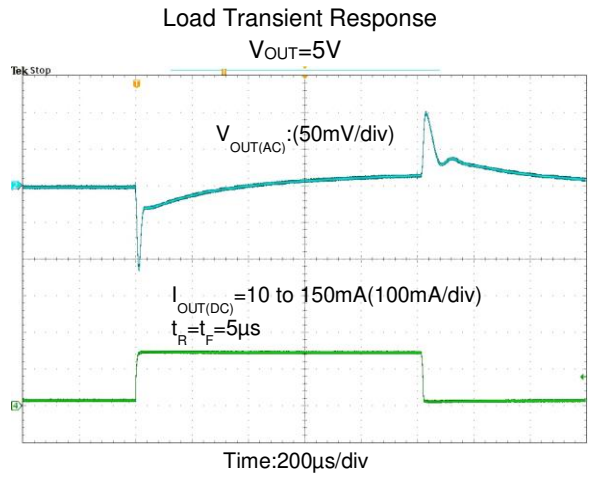
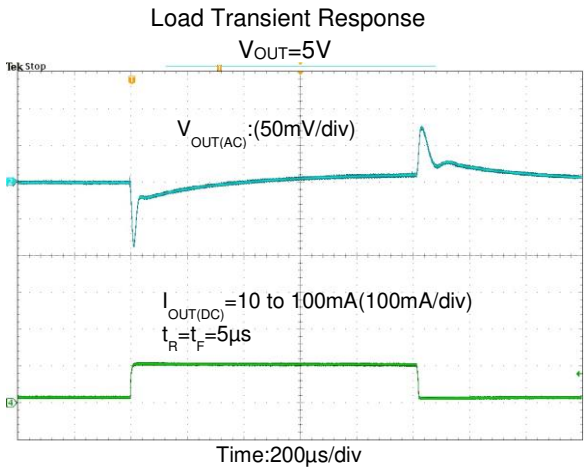

Application Information

Output Capacitor

An output capacitor is required for the stability of the LDO. The recommended minimum output capacitance is 1 μ F. A ceramic capacitor is recommended with the temperature characteristics of X7R or X5R. Higher capacitance values help to improve load/line transient response. The output capacitance may be increased to keep low undershoot/overshoot. Place the output capacitor as close as possible to VOUT and GND pins.

Input Capacitor

A 1 μ F ceramic capacitor is recommended to connect between VIN and GND pins to decouple input power supply glitch and noise. The amount of the capacitance may be increased without limit. This input capacitor must be located as close as possible to the device to ensure input stability and less noise. For PCB layout, a wide copper trace is required for both VIN and GND.

Current-Limit and Short-Circuit Protection

When the output current at VOUT pin is higher than the current-limit threshold or the VOUT pin is directly shorted to GND, current-limit protection will be triggered and clamp the output current at a pre-designed level to prevent overcurrent and thermal damage.

Thermal Protection

The AP7387 has internal thermal sense and protection circuits. When excessive power dissipation happens on the device, such as short circuit at the output pin or very heavy load current with a large voltage drop across the device, the internal thermal protection circuit will be triggered, and it will shut down the power MOSFET to prevent the LDO from damage. As soon as the excessive thermal condition is removed and the temperature of the device drops down, the thermal protection circuit will release the control of the power MOSFET and the LDO device will return to normal operation.

Layout Considerations

For good ground loop and stability, the input and output capacitors should be located close to the input, output, and ground pins of the device. The regulator ground pin should be connected to the external circuit ground to reduce voltage drop caused by trace impedance. Ground plane is generally used to reduce trace impedance. Wide trace should be used for large current paths from VIN to VOUT, and load circuit.

Ordering Information

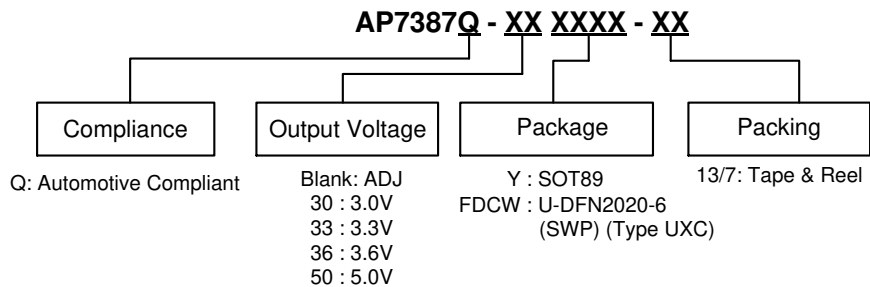

Part Number	Part Number Suffix	Package	Package Code	Packing	
				Qty.	Carrier
AP7387Q-XXY-13	-13	SOT89	Y	2,500	13" Tape & Reel
AP7387Q-XXFDCW-7	-7	U-DFN2020-6 (SWP) (Type UXC)	FDCW	3,000	7" Tape & Reel

Marking Information

(1) SOT89

(Top View)

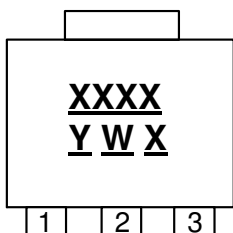

XXXX : Identification Code
Y : Year : 0 to 9 (ex: 2 = 2022)
W : Week : A to Z : week 1 to 26;
a to z : week 27 to 52;
z represents week 52 and 53
X : Internal Code

Part Number	Package	Identification Code
AP7387Q-30Y-13	SOT89	H7AQ
AP7387Q-33Y-13	SOT89	H7BQ
AP7387Q-36Y-13	SOT89	H7CQ
AP7387Q-50Y-13	SOT89	H7DQ

(2) U-DFN2020-6 (SWP) (Type UXC)

(Top View)

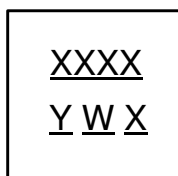

XXXX : Identification Code
Y : Year : 0 to 9 (ex: 2 = 2022)
W : Week : A to Z : week 1 to 26;
a to z : week 27 to 52; z represents
week 52 and 53
X : Internal Code

Part Number	Package	Identification Code
AP7387Q-30FDCW-7	U-DFN2020-6 (SWP) (Type UXC)	H7AQ
AP7387Q-33FDCW-7	U-DFN2020-6 (SWP) (Type UXC)	H7BQ
AP7387Q-36FDCW-7	U-DFN2020-6 (SWP) (Type UXC)	H7CQ
AP7387Q-50FDCW-7	U-DFN2020-6 (SWP) (Type UXC)	H7DQ

Package Outline Dimensions

Please see <http://www.diodes.com/package-outlines.html> for the latest version.

SOT89

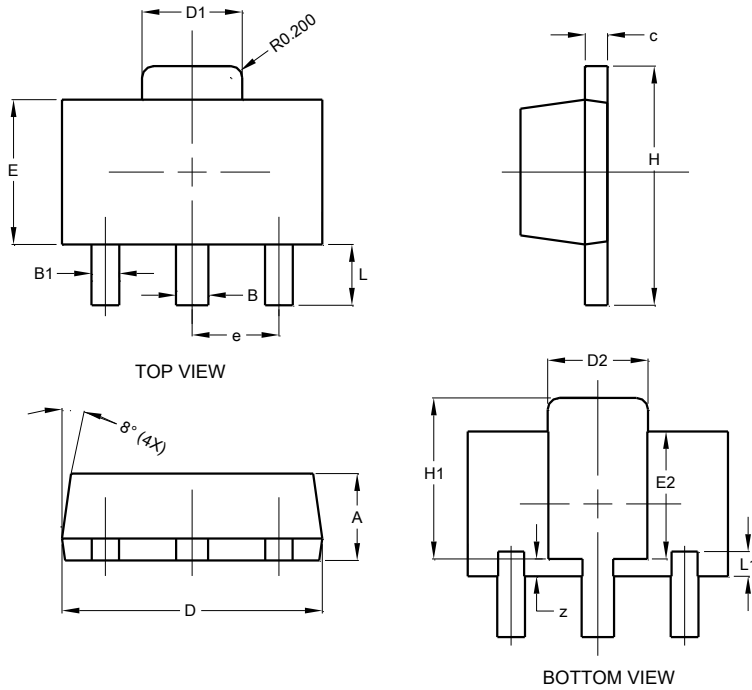

SOT89			
Dim	Min	Max	Typ
A	1.40	1.60	1.50
B	0.50	0.62	0.56
B1	0.42	0.54	0.48
c	0.35	0.43	0.38
D	4.40	4.60	4.50
D1	1.62	1.83	1.733
D2	1.61	1.81	1.71
E	2.40	2.60	2.50
E2	2.05	2.35	2.20
e	-	-	1.50
H	3.95	4.25	4.10
H1	2.63	2.93	2.78
L	0.90	1.20	1.05
L1	0.327	0.527	0.427
z	0.20	0.40	0.30
All Dimensions in mm			

U-DFN2020-6 (SWP) (Type UXC)

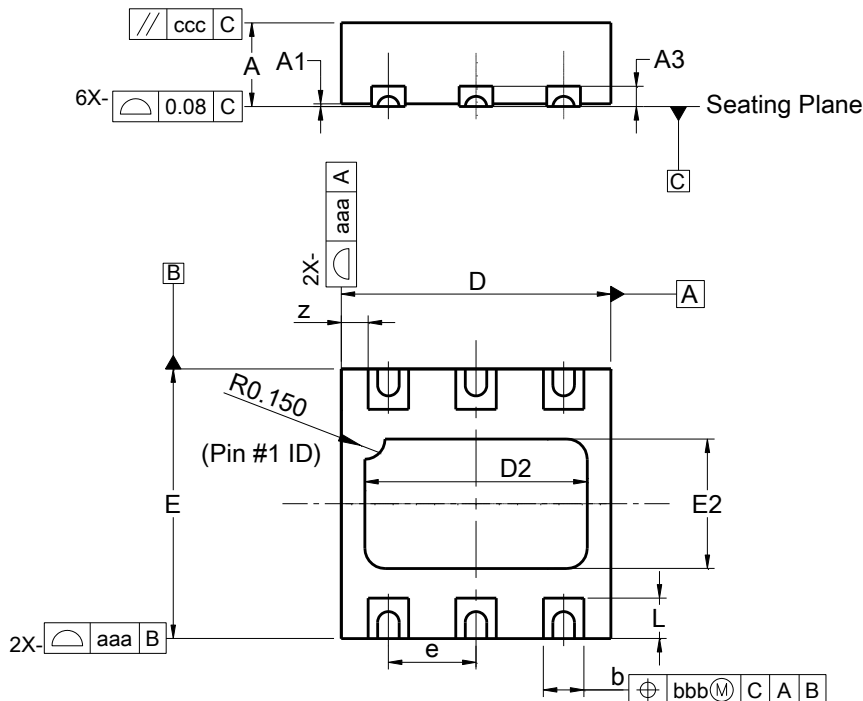

U-DFN2020-6 (SWP) (Type UXC)			
Dim	Min	Max	Typ
A	0.57	0.63	0.60
A1	0.00	0.05	0.02
A3	—	—	0.13
b	0.25	0.35	0.30
D	1.95	2.075	2.00
D2	1.55	1.75	1.65
E	1.95	2.075	2.00
E2	0.86	1.06	0.96
e	—	—	0.65
L	0.25	0.35	0.30
z	—	—	0.20
aaa	0.25		
bbb	0.10		
ccc	0.10		
All Dimensions in mm			

Suggested Pad Layout

Please see <http://www.diodes.com/package-outlines.html> for the latest version.

SOT89

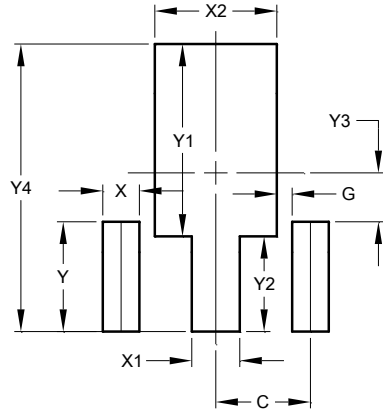

Dimensions	Value (in mm)
C	1.500
G	0.244
X	0.580
X1	0.760
X2	1.933
Y	1.730
Y1	3.030
Y2	1.500
Y3	0.770
Y4	4.530

U-DFN2020-6 (SWP) (Type UXC)

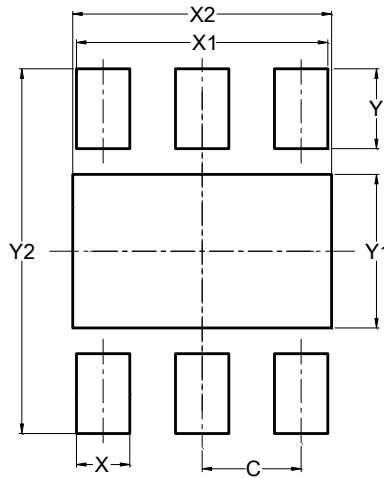

Dimensions	Value (in mm)
C	0.650
X	0.350
X1	1.650
X2	1.700
Y	0.525
Y1	1.010
Y2	2.400

Mechanical Data

- Moisture Sensitivity: Level 1 Per J-STD-020
- Terminals:
 - SOT89: Finish – Matte Tin Plated Leads, Solderable per MIL-STD-202, Method 208 [Ⓔ]
 - U-DFN2020-6 (SWP) (Type UXC): Finish – NiPdAu over Copper Leads, Solderable per MIL-STD-202, Method 208 [Ⓔ]
- Weight:
 - SOT89: 0.056 grams (Approximate)
 - U-DFN2020-6 (SWP) (Type UXC): 0.007 grams (Approximate)

IMPORTANT NOTICE

1. DIODES INCORPORATED (Diodes) AND ITS SUBSIDIARIES MAKE NO WARRANTY OF ANY KIND, EXPRESS OR IMPLIED, WITH REGARDS TO ANY INFORMATION CONTAINED IN THIS DOCUMENT, INCLUDING, BUT NOT LIMITED TO, THE IMPLIED WARRANTIES OF MERCHANTABILITY, FITNESS FOR A PARTICULAR PURPOSE OR NON-INFRINGEMENT OF THIRD PARTY INTELLECTUAL PROPERTY RIGHTS (AND THEIR EQUIVALENTS UNDER THE LAWS OF ANY JURISDICTION).
2. The Information contained herein is for informational purpose only and is provided only to illustrate the operation of Diodes' products described herein and application examples. Diodes does not assume any liability arising out of the application or use of this document or any product described herein. This document is intended for skilled and technically trained engineering customers and users who design with Diodes' products. Diodes' products may be used to facilitate safety-related applications; however, in all instances customers and users are responsible for (a) selecting the appropriate Diodes products for their applications, (b) evaluating the suitability of Diodes' products for their intended applications, (c) ensuring their applications, which incorporate Diodes' products, comply the applicable legal and regulatory requirements as well as safety and functional-safety related standards, and (d) ensuring they design with appropriate safeguards (including testing, validation, quality control techniques, redundancy, malfunction prevention, and appropriate treatment for aging degradation) to minimize the risks associated with their applications.
3. Diodes assumes no liability for any application-related information, support, assistance or feedback that may be provided by Diodes from time to time. Any customer or user of this document or products described herein will assume all risks and liabilities associated with such use, and will hold Diodes and all companies whose products are represented herein or on Diodes' websites, harmless against all damages and liabilities.
4. Products described herein may be covered by one or more United States, international or foreign patents and pending patent applications. Product names and markings noted herein may also be covered by one or more United States, international or foreign trademarks and trademark applications. Diodes does not convey any license under any of its intellectual property rights or the rights of any third parties (including third parties whose products and services may be described in this document or on Diodes' website) under this document.
5. Diodes' products are provided subject to Diodes' Standard Terms and Conditions of Sale (<https://www.diodes.com/about/company/terms-and-conditions/terms-and-conditions-of-sales/>) or other applicable terms. This document does not alter or expand the applicable warranties provided by Diodes. Diodes does not warrant or accept any liability whatsoever in respect of any products purchased through unauthorized sales channel.
6. Diodes' products and technology may not be used for or incorporated into any products or systems whose manufacture, use or sale is prohibited under any applicable laws and regulations. Should customers or users use Diodes' products in contravention of any applicable laws or regulations, or for any unintended or unauthorized application, customers and users will (a) be solely responsible for any damages, losses or penalties arising in connection therewith or as a result thereof, and (b) indemnify and hold Diodes and its representatives and agents harmless against any and all claims, damages, expenses, and attorney fees arising out of, directly or indirectly, any claim relating to any noncompliance with the applicable laws and regulations, as well as any unintended or unauthorized application.
7. While efforts have been made to ensure the information contained in this document is accurate, complete and current, it may contain technical inaccuracies, omissions and typographical errors. Diodes does not warrant that information contained in this document is error-free and Diodes is under no obligation to update or otherwise correct this information. Notwithstanding the foregoing, Diodes reserves the right to make modifications, enhancements, improvements, corrections or other changes without further notice to this document and any product described herein. This document is written in English but may be translated into multiple languages for reference. Only the English version of this document is the final and determinative format released by Diodes.
8. Any unauthorized copying, modification, distribution, transmission, display or other use of this document (or any portion hereof) is prohibited. Diodes assumes no responsibility for any losses incurred by the customers or users or any third parties arising from any such unauthorized use.
9. This Notice may be periodically updated with the most recent version available at <https://www.diodes.com/about/company/terms-and-conditions/important-notice>

DIODES is a trademark of Diodes Incorporated in the United States and other countries.
The Diodes logo is a registered trademark of Diodes Incorporated in the United States and other countries.
© 2022 Diodes Incorporated. All Rights Reserved.

www.diodes.com