

RUGGED STEEL BATTERY HOLDERS



An established design that has gained wide acceptance for commercial and military applications. Batteries are held under constant spring tension assuring low contact resistance. Retainer clips are available to lock batteries in place and prevent shifting or loosening. Refer to page 10. Recommended for use where shock or severe vibration is encountered. Special fabrication for more than four batteries or variations from standard stock parts can be assembled to meet your requirements.

- Ideal for NiCd, Alkaline, NiMH, Carbon, Zinc and Lithium Cells
- Corrosion Resistant, Nickel Plate
- Brass Contacts, Nickel Plate
- Moisture Proof Resin Impregnated, Fibre Insulating Washers

FIG. 1 STAINLESS STEEL BASE. INSULATOR TUBES SUPPLIED FOR 2-3-4 CELLS (END TO END)

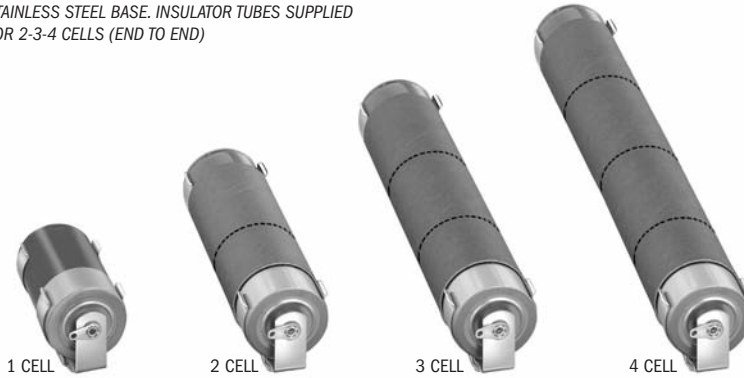

FIG. 2 STEEL BASE. LITHIUM (SINGLE CELL)



FIG. 3 PHENOLIC BASE FOR 2, 3, 4 CELLS (SIDE BY SIDE)



STEEL BATTERY HOLDERS

1100 SERIES	2100 SERIES	BATTERY CROSS REFERENCE					
ONE CONTACT INSULATED	ALL CONTACTS INSULATED	HOLDS NO. OF CELLS	FIG. NO.	EVEREADY	DURACELL	RAY-O-VAC	NEDA
CAT. NO.	CAT. NO.						
"AA" CELL HOLDERS (BATTERY SIZE .531 (13.4) O.D. x 1.906 (48.4) L)							
1139	2139	1	1	E9, EV15, EN91, CH15, E133, E133N, E177, 505, 523, 1015, 1215	ZM9, RM12R, NC15AA, M15F, M15AA, TR133R, TR177, M505, MN1500, PC1500	5AA, 615, 815, 7AA	15, 15A, 15C, 15D, 15F, 15M, 15NC, 221, 1101M, 1113M, 1306AP, 1306M, 1314M, 1606M
—	2140*	2	3				
—	2171*	3	3				
—	2182*	4	3				
1189	2189	2	1				
1191	2191	3	1				
1194	2194	4	1				
"C" CELL HOLDERS (BATTERY SIZE .875 (22.2) O.D. x 1.875 (47.6) L)							
1173	2173	1	1	CH35, E93, 935, 1235, EV35, EN93	M14F, M14HD, NC14C, TR286, MN1400, PC1400	1C, 614, 814	14A, 14C, 14D, 14F, 14NC, 1600M
—	2174*	2	3				
—	2187*	3	3				
—	2188*	4	3				
1185	2185	2	1				
1195	2195	3	1				
1198	2198	4	1				
"D" CELL HOLDERS (BATTERY SIZE 1.187 (30.1) O.D. x 2.312 (58.7) L)							
1175	2175	1	1	CH50, E95, 950, 1250, EV50, EN95	M13F, NC13D, S42, M13HD, TR289, MN1300, PC1300	2D, 6D, 613, 813	13A, 13C, 13D, 13F, 13NC, 1115M, 1810M
—	2176*	2	3				
—	2190*	3	3				
—	2192*	4	3				
1186	2186	2	1				
1199	2199	3	1				
1162	2162	4	1				

1100 SERIES

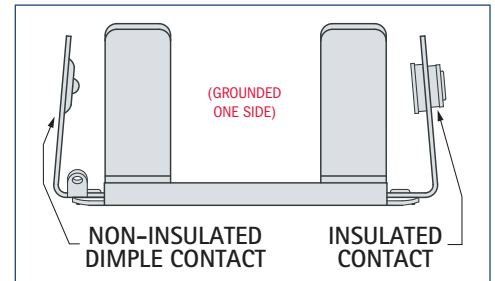

2100 SERIES

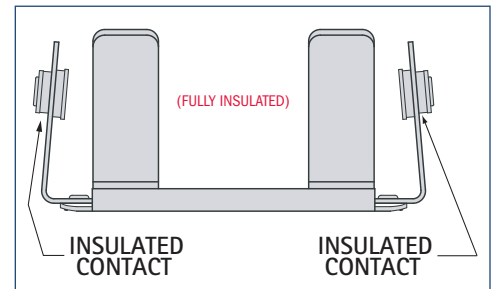

MODIFICATIONS

We welcome the opportunity to quote on variations of standard items. Use our engineering service for your custom-built holders. Holders with PC and Quick-Fit terminals available on special order.

LITHIUM CELL HOLDERS	BATTERY	FIG. NO.	BATTERY SIZE	DURACELL	PANASONIC	SANYO
ALL CONTACTS INSULATED						
1103	"1/2 AA"	2	.510 (12.95) x .990 (25.15)	Px28L	CR14250	CR14250SE
1105	"1/2 A"	2	.661 (16.80) x .886 (22.50)	BR-1/2A	—	—

*Clips mounted on .062 (1.57) thick Phenolic board.

DIMENSIONAL DRAWINGS FOR STEEL BATTERY HOLDERS

MATERIAL SPECIFICATIONS:

Clips: Spring Steel, Nickel Plate
Contact Eyelets: Brass, Nickel Plate
Insulating Washers: Moisture Proof, Resin Impregnated Fibre
Solder Lugs: Brass, Tin Plate

Phenolic Base: Type PBE, Per MIL-P-3115C
Stainless Steel Base: Ribbed, For Added Support
Steel Base: Spring Steel, Nickel Plate

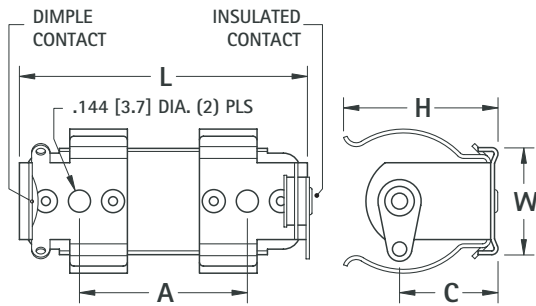

DWG. 1 FOR 1100 SERIES STAINLESS STEEL BASE (END-TO-END)

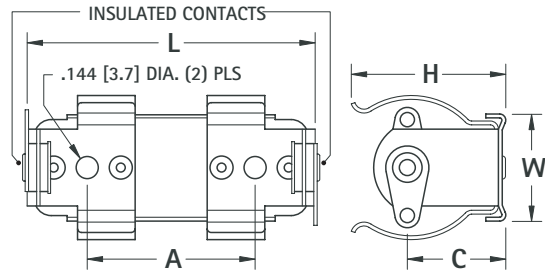

DWG. 1 FOR 2100 SERIES STAINLESS STEEL BASE (END-TO-END)

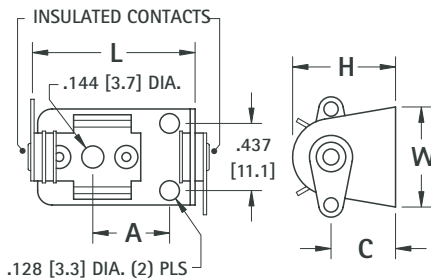

DWG. 2 FOR LITHIUM STEEL BASE (SINGLE CELL)

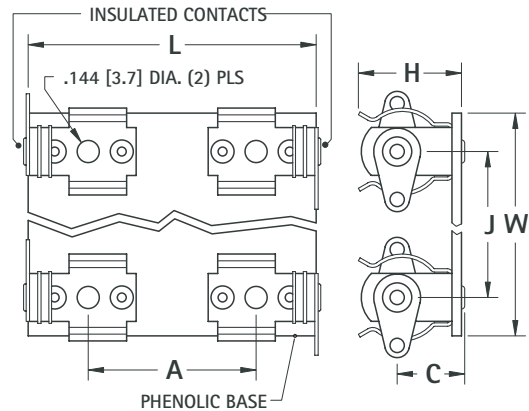

DWG. 3 FOR 2100 SERIES PHENOLIC BASE (SIDE-BY-SIDE)

1100 SERIES ONE CONTACT INSULATED	2100 SERIES ALL CONTACTS INSULATED	HOLDS NO. OF CELLS	DWG. NO.	W	L	H	C	J	A
CAT. NO.	CAT. NO.			Width Of Base	Length Of Base	Height Of Holder	Height to Battery Center	Mounting Hole Distance	Mounting Holes Center To Center
"AA" CELL HOLDERS									
1139	2139	1	1	.687 (17.4)	2.125 (54.0)	.656 (16.7)	.437 (11.1)	—	1.343 (34.1)
—	2140*	2	3	1.250 (31.8)	2.125 (54.0)	.656 (16.7)	.437 (11.1)	.750 (19.1)	1.343 (34.1)
—	2171*	3	3	2.000 (50.8)	2.125 (54.0)	.656 (16.7)	.437 (11.1)	.750 (19.1)	1.343 (34.1)
—	2182*	4	3	2.750 (69.9)	2.125 (54.0)	.656 (16.7)	.437 (11.1)	.750 (19.1)	1.343 (34.1)
1189	2189	2	1	.687 (17.4)	4.093 (104.0)	.656 (16.7)	.437 (11.1)	—	3.312 (84.1)
1191	2191	3	1	.687 (17.4)	6.030 (153.2)	.656 (16.7)	.437 (11.1)	—	5.250 (133.4)
1194	2194	4	1	.687 (17.4)	8.010 (203.5)	.656 (16.7)	.437 (11.1)	—	7.230 (183.6)
"C" CELL HOLDERS									
1173	2173	1	1	.687 (17.4)	2.125 (54.0)	1.000 (25.4)	.625 (15.9)	—	1.343 (34.1)
—	2174*	2	3	1.750 (44.5)	2.062 (52.4)	1.000 (25.4)	.625 (15.9)	1.187 (30.1)	1.343 (34.1)
—	2187*	3	3	2.937 (74.6)	2.062 (52.4)	1.000 (25.4)	.625 (15.9)	1.187 (30.1)	1.343 (34.1)
—	2188*	4	3	4.125 (104.8)	2.062 (52.4)	1.000 (25.4)	.625 (15.9)	1.187 (30.1)	1.343 (34.1)
1185	2185	2	1	.687 (17.4)	4.093 (104.0)	1.000 (25.4)	.625 (15.9)	—	3.312 (84.1)
1195	2195	3	1	.687 (17.4)	5.937 (150.8)	1.000 (25.4)	.625 (15.9)	—	5.156 (131.0)
1198	2198	4	1	.687 (17.4)	7.906 (200.8)	1.000 (25.4)	.625 (15.9)	—	7.125 (181.0)
"D" CELL HOLDERS									
1175	2175	1	1	.687 (17.4)	2.562 (65.1)	1.281 (32.5)	.796 (20.2)	—	1.625 (41.3)
—	2176*	2	3	2.125 (54.0)	2.562 (65.1)	1.281 (32.5)	.796 (20.2)	1.562 (39.7)	1.625 (41.3)
—	2190*	3	3	3.687 (93.6)	2.562 (65.1)	1.281 (32.5)	.796 (20.2)	1.562 (39.7)	1.625 (41.3)
—	2192*	4	3	5.250 (133.4)	2.562 (65.1)	1.281 (32.5)	.796 (20.2)	1.562 (39.7)	1.625 (41.3)
1186	2186	2	1	.687 (17.4)	4.937 (125.4)	1.281 (32.5)	.796 (20.2)	—	4.000 (101.6)
1199	2199	3	1	.687 (17.4)	7.281 (184.9)	1.281 (32.5)	.796 (20.2)	—	6.343 (161.1)
1162	2162	4	1	.687 (17.4)	9.625 (244.5)	1.281 (32.5)	.796 (20.2)	—	8.687 (220.6)
LITHIUM CELL HOLDERS									
1103		1	2	.625 (15.9)	1.156 (29.4)	.595 (15.1)	.345 (8.8)	—	.531 (13.5)
1105		1	2	.390 (9.9)	1.044 (26.5)	.670 (17.0)	.420 (10.7)	—	.500 (12.7)

*Clips mounted on .062 (1.57) thick Phenolic board.

DIMENSIONS ARE FOR REFERENCE ONLY



Lightweight yet strong, constructed of aircraft grade aluminum. Batteries snap-fit securely into clips.

- Brass Eyelets, Nickel Plate
- Brass Lugs, Nickel Plate
- Moisture Proof, Resin Impregnated, Fibre Insulating Washers
- Aluminum 2024-T3, Frame & Clip

FIG. 1



1 CELL

FIG. 2



2 CELL

FIG. 3

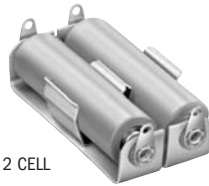

2 CELL

FIG. 4

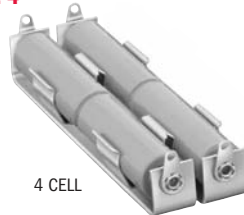

4 CELL

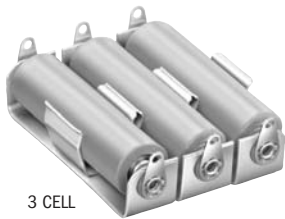

3 CELL

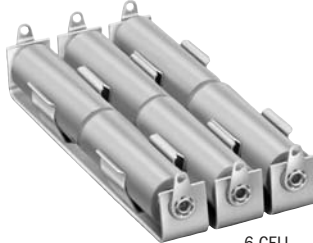

6 CELL
CAT. NO. 193
CAT. NO. 197
CAT. NO. 201



4 CELL

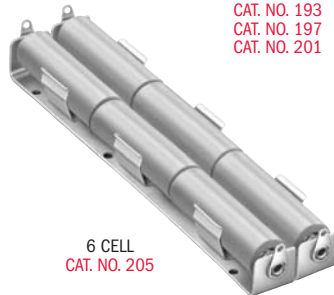

6 CELL
CAT. NO. 205

FIG. 5



FIG. 6



CAT. NO.	HOLDS NO. OF CELLS	FIG. NO.	BATTERY CROSS REFERENCE			
			EVEREADY	DURACELL	RAY-O-VAC	NEDA
“AAA” CELL HOLDERS			(BATTERY SIZE $\frac{.375 (9.5)}{.468 (11.9)}$ O.D. $\times \frac{1.673 (42.5)}{1.752 (44.5)}$ L)			
137	1	1	E92, 912, CH12	M24F, MN2400	824	24A, 24F, 24P
138	2	3				
169	3	3				
170	4	3				
“AA” CELL HOLDERS			(BATTERY SIZE $\frac{.531 (13.4)}{.561 (14.5)}$ O.D. $\times \frac{1.906 (48.4)}{1.988 (50.5)}$ L)			
139	1	1	E9, EV15, EN91, CH15, E133, E133N, E177, 505, 523, 1015, 1215	ZM9, RM12R, NC15AA, M15F, M15AA, TR133R, TR177, M505, MN1500, PC1500	5AA, 615, 815, 7AA	15, 15A, 15C, 15D, 15F, 15M, 15NC, 221, 1101M, 1113M, 1306AP, 1306M, 1314M, 1606M
140	2	3				
171	3	3				
182	4	3				
189	2	2				
192	4	4				
193	6	4				
“C” CELL HOLDERS			(BATTERY SIZE $\frac{.875 (22.2)}{1.125 (28.6)}$ O.D. $\times \frac{1.875 (47.6)}{1.969 (50.5)}$ L)			
173	1	1	CH35, E93, 935, 1235, EV35, EN93	M14F, M14HD, NC14C, TR286, MN1400, PC1400	1C, 614, 814,	14A, 14C, 14D, 14F, 14NC, 1600M
174	2	3*				
185	2	2				
187	3	3				
196	4	4**				
197	6	4				
“D” CELL HOLDERS			(BATTERY SIZE $\frac{1.187 (30.1)}{1.375 (34.9)}$ O.D. $\times \frac{2.312 (58.7)}{2.412 (61.3)}$ L)			
175	1	1	CH50, E95, 950, 1250, EV50, EN95	M13F, NC13D, S42, M13HD, TR289, MN1300, PC1300	2D, 6D, 613, 813	13A, 13C, 13D, 13F, 13NC, 1115M, 1810M
176	2	3*				
190	3	3				
186	2	2				
200	4	4**				
201	6	4				
205	6	4***				
“N” CELL HOLDERS			(BATTERY SIZE $\frac{.375 (9.5)}{.468 (11.9)}$ O.D. $\times \frac{1.110 (28.2)}{1.189 (30.2)}$ L)			
154	1	1	E90, E340E, E401E, EP401, EP401E	MP401H	R401, RP401, 810	910A, 910F, 910M, 1117M, 1118M, MN9100
155	2	3				
156	3	3				
“9 VOLT” BATTERY HOLDERS						
203-P	REFER TO PAGE 21		CH22, EN22, E146X, 216, 522, 1222, E303396	TR146X, M1604, M1604HD, MN16 PC146X,	A1604, D1604, 1604	1604A, 1604C, 1604D, 1604M, 1604NC, 1619M
303-P						
1290†						
1290-79						
1291†						
1291-79						
LITHIUM “2/3A” CELL HOLDER						
131	1	1	—	DL-2/3A	BR-2/3A	CR-173355E
“15 VOLT” BATTERY HOLDERS						
161	1	5	—	—	—	224
163	1	5	—	—	—	225
167	2	6*	411	—	—	208
“22½ VOLT” BATTERY HOLDERS						
139	1	1	505	—	—	221
168	1	5	420	—	—	225
177	1	5	M215	M215	—	215
178	2	6*	—	—	—	—
“30 VOLT” BATTERY HOLDERS						
183	1	5	413	—	—	210
184	1	6*	—	—	—	—

* 1 Clip holds two batteries in place. ** 2 Clips hold four batteries in place. *** 3 Clips hold six batteries in place. † Recommended for battery thickness under .640 (16.3)

MODIFICATIONS

We welcome the opportunity to quote on variations of standard items. Use our engineering service for your custom-built holders. Holders with PC and Quick-Fit terminals available on special order.

DIMENSIONAL DRAWINGS FOR ALUMINUM BATTERY HOLDERS

MATERIAL SPECIFICATIONS

Insulating Washers: Moisture proof, resin impregnated fibre
Terminal Lugs: Brass, Tin Plate

Frame and Clips: Aluminum 2024-T3
Contact Eyelet: Brass, Nickel Plate

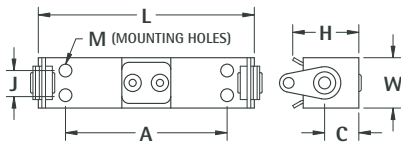

DWG. 1

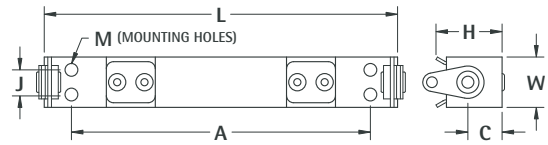

DWG. 2

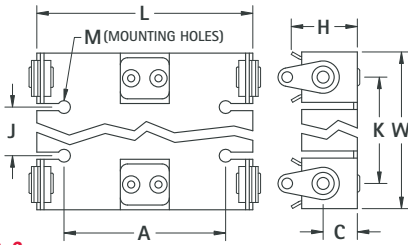

DWG. 3

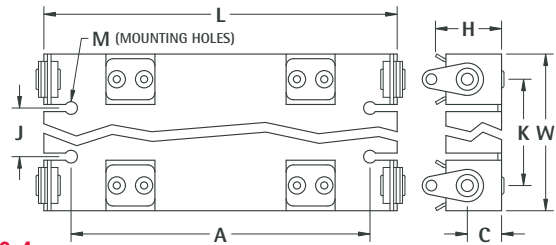

DWG. 4

CAT. NO.	FIG. NO.	W	L	H	C	K	J	A	M
		Width	Length	Height	Battery Center Height	Distance Between Battery Centers	Mounting Holes Width	Mounting Holes Length	Mounting Holes (Diameter)
"AAA"									
137	1	.437 (11.1)	1.915 (48.6)	.467 (11.9)	.281 (7.1)	—	.250 (6.4)	1.500 (38.1)	.111 (2.8)
138	3	.812 (20.6)	1.915 (48.6)	.467 (11.9)	.281 (7.1)	.437 (11.1)	—	.875 (22.2)	.140 (3.6)
169	3	1.250 (31.8)	1.915 (48.6)	.467 (11.9)	.281 (7.1)	.437 (11.1)	.438 (11.1)	.875 (22.2)	.144 (3.7)
170	3	1.687 (42.8)	1.915 (48.6)	.467 (11.9)	.281 (7.1)	.437 (11.1)	.875 (22.2)	.875 (22.2)	.144 (3.7)
"AA"									
139	1	.625 (15.9)	2.140 (54.4)	.578 (14.7)	.392 (10.0)	—	.406 (10.3)	1.500 (38.1)	.111 (2.8)
140	3	1.125 (28.6)	2.156 (54.8)	.562 (14.3)	.375 (9.5)	.625 (15.9)	—	1.218 (30.9)	.144 (3.7)
171	3	1.750 (44.5)	2.140 (54.4)	.578 (14.7)	.392 (10.0)	.625 (15.9)	.625 (15.9)	1.218 (30.9)	.144 (3.7)
182	3	2.656 (67.5)	2.140 (54.4)	.615 (15.6)	.421 (10.7)	.718 (18.2)	1.437 (36.5)	1.218 (30.9)	.144 (3.7)
189	2	.625 (15.9)	4.110 (104.4)	.593 (15.1)	.406 (10.3)	—	.437 (11.1)	3.000 (76.2)	.128 (3.3)
192	4	1.125 (28.6)	4.093 (104.0)	.593 (15.1)	.406 (10.3)	.625 (15.9)	—	3.093 (78.6)	.144 (3.7)
193	4	1.750 (44.5)	4.093 (104.0)	.593 (15.1)	.406 (10.3)	.625 (15.9)	.625 (15.9)	3.125 (79.4)	.144 (3.7)
"C"									
173	1	.750 (19.1)	2.093 (53.2)	.968 (24.6)	.593 (15.1)	—	.437 (11.1)	1.500 (38.1)	.144 (3.7)
174	3*	1.625 (41.3)	2.093 (53.2)	1.120 (28.4)	.593 (15.1)	1.000 (25.4)	—	1.250 (31.75)	.144 (3.7)
185	2	.750 (19.1)	4.046 (102.8)	.968 (24.6)	.593 (15.1)	—	.500 (12.7)	3.187 (80.9)	.144 (3.7)
187	3	2.843 (72.1)	2.125 (54.0)	.968 (24.6)	.593 (15.1)	1.125 (28.6)	1.125 (28.6)	1.250 (31.8)	.144 (3.7)
196	4**	1.625 (41.3)	4.075 (103.5)	1.120 (28.4)	.593 (15.1)	—	—	3.187 (80.9)	.144 (3.7)
197	4	2.875 (73.0)	4.075 (103.5)	.968 (24.6)	.593 (15.1)	1.000 (25.4)	1.000 (25.4)	3.187 (80.9)	.144 (3.7)
"D"									
175	1	1.000 (25.4)	2.562 (65.1)	1.262 (32.1)	.763 (19.4)	—	.750 (19.1)	1.750 (44.5)	.128 (3.3)
176	3*	2.062 (52.4)	2.562 (65.1)	1.468 (37.3)	.741 (18.8)	1.312 (33.3)	—	1.500 (38.1)	.144 (3.7)
186	2	1.000 (25.4)	4.921 (125.0)	1.262 (32.1)	.747 (19.0)	—	.687 (17.4)	4.125 (104.8)	.128 (3.3)
190	3	3.375 (85.7)	2.562 (65.1)	1.262 (32.1)	.775 (19.7)	1.350 (34.3)	1.125 (28.6)	1.937 (49.2)	.144 (3.7)
200	4**	2.062 (52.4)	4.870 (123.7)	1.468 (37.3)	.741 (18.8)	1.312 (33.3)	—	4.375 (111.1)	.144 (3.7)
201	4	3.375 (85.7)	4.920 (125.0)	1.262 (32.1)	.775 (19.7)	1.343 (34.1)	1.125 (28.6)	4.250 (108.6)	.144 (3.7)
205	4***	2.062 (52.4)	7.270 (184.7)	1.468 (37.3)	.741 (18.8)	1.312 (33.3)	—	6.750 (171.5)	.144 (3.7)
"N"									
154	1	.437 (11.1)	1.328 (33.7)	.483 (12.3)	.297 (7.5)	—	.250 (6.4)	.906 (23.0)	.111 (2.8)
155	3	.937 (23.8)	1.347 (34.2)	.483 (12.3)	.297 (7.5)	.500 (12.7)	—	.875 (22.2)	.128 (3.3)
156	3	1.500 (38.1)	1.347 (34.2)	.483 (12.3)	.297 (7.5)	.531 (13.5)	.562 (14.3)	.875 (22.2)	.111 (2.8)
LITHIUM BATTERY HOLDERS									
131	1	.625 (15.9)	1.474 (37.4)	.625 (15.9)	.437 (11.1)	—	.437 (11.1)	1.125 (28.6)	.111 (2.8)
"15 V"									
161	1	0.75 (19.1)	1.625 (41.3)	.589 (15.0)	.397 (10.1)	—	.562 (14.3)	1.000 (25.4)	.140 (3.6)
163	1	1.000 (25.4)	1.750 (44.5)	1.250 (31.8)	.488 (12.4)	—	.720 (18.3)	1.125 (28.6)	.140 (3.6)
167	1*	1.125 (28.6)	1.625 (41.3)	1.262 (32.1)	.586 (14.9)	.593 (15.1)	—	1.000 (25.4)	.128 (3.3)
"22 1/2 V"									
139	1	.625 (15.9)	2.140 (54.4)	.578 (14.7)	.392 (10.0)	—	.406 (10.3)	1.500 (38.1)	.111 (2.8)
168	1	.750 (19.1)	2.336 (59.3)	.944 (24.0)	.493 (12.5)	—	.435 (11.1)	1.500 (38.1)	.140 (3.6)
177	1	.750 (19.1)	2.093 (53.2)	1.156 (29.4)	.610 (15.5)	—	.437 (11.1)	1.500 (38.1)	.140 (3.6)
178	3*	1.125 (28.6)	2.078 (52.8)	1.262 (32.1)	.619 (15.72)	.625 (15.9)	—	1.218 (30.9)	.144 (3.7)
"30 V"									
183	1	.750 (19.1)	2.687 (68.2)	1.156 (29.4)	.613 (15.6)	—	.562 (14.3)	1.750 (44.5)	.111 (2.8)
184	3*	1.125 (28.6)	2.687 (68.2)	1.262 (32.1)	.594 (15.1)	.625 (15.9)	—	1.812 (46.0)	.144 (3.7)

*1 Clip to holds two batteries in place.

**2 Clips hold four batteries in place.

***3 Clips hold six batteries in place.

DIMENSIONS ARE FOR REFERENCE ONLY

ELIMINATES WIRING · LABOR SAVING

Features jumper straps insulated from the Aluminum base. Batteries held in series circuit without need of additional wiring.

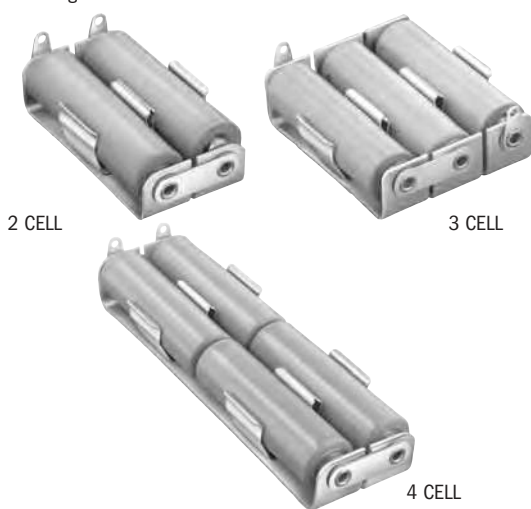

CAT. NO.	HOLDS NO. OF CELLS	BATTERY CROSS REFERENCE			
		EVEREADY	DURACELL	RAY-O-VAC	NEDA
		"AA" CELL HOLDERS (BATTERY .531 (13.4) O.D. × 1.906 (48.4) L) SIZE .565 (14.5) 1.988 (50.5)			
146	2	E9, EV15, EN91, CH15, E133, E133N, E177, 505, 523, 1015, 1215	ZM9, RM12R, NC15AA, M15F, M15AA, TR133R, TR177, M505, MN1500, PC1500	5AA, 615, 815, 7AA	15, 15A, 15C, 15D, 15F, 15M, 15NC, 221, 1101M, 1113M, 1306AP, 1306M, 1314M, 1606M
147	3				
148	4				
		"C" CELL HOLDERS (BATTERY .875 (22.2) O.D. × 1.875 (47.6) L) SIZE 1.125 (28.6) 1.969 (50.0)			
149	2	CH35, E93, 935, 1235, EV35, EN93	M14F, M14HD, NC14C, TR286, MN1400, PC1400	1C, 614, 814,	14A, 14C, 14D, 14F, 14NC, 1600M
150	3				
151	4				
		"D" CELL HOLDERS (BATTERY 1.187 (30.1) O.D. × 2.312 (58.7) L) SIZE 1.375 (34.9) 2.412 (61.3)			
152	2	CH50, E95, 950, 1250, EV50, EN95	M13F, NC13D, S42, M13HD, TR289, MN1300, PC1300	2D, 6D, 613, 813	13A, 13C, 13D, 13F, 13NC, 1115M, 1810M
153	3				
158	4				

ALUMINUM HOLDERS WITH PC LUGS

ELIMINATES WIRING · LABOR SAVING

For printed circuitry we have standardized our most popular holders with PC Lugs. Choice of single or multiple holders. "AA" assembled with Cat. No. 4002 lug. "C" and "D" assembled with Cat. No. 4003 lug. (Refer to page 50)

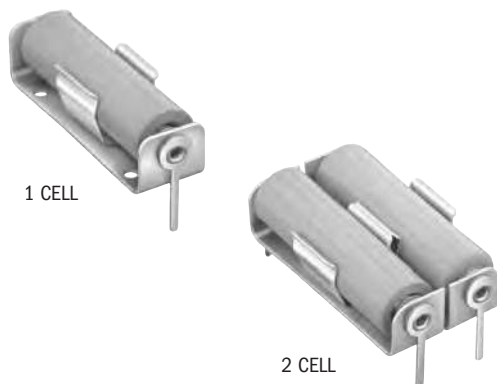

CAT. NO.	HOLDS NO. OF CELLS	BATTERY CROSS REFERENCE			
		EVEREADY	DURACELL	RAY-O-VAC	NEDA
		"AA" CELL HOLDERS (BATTERY .531 (13.4) O.D. × 1.906 (48.4) L) SIZE .565 (14.5) 1.988 (50.5)			
2222	1	E9, EV15, EN91, CH15, E133, E133N, E177, 505, 523, 1015, 1215	ZM9, RM12R, NC15AA, M15F, M15AA, TR133R, TR177, M505, MN1500, PC1500	5AA, 615, 815, 7AA	15, 15A, 15C, 15D, 15F, 15M, 15NC, 221, 1101M, 1113M, 1306AP, 1306M, 1314M, 1606M
2223	2				
		"C" CELL HOLDERS (BATTERY .875 (22.2) O.D. × 1.875 (47.6) L) SIZE 1.125 (28.6) 1.969 (50.0)			
2224	1	CH35, E93, 935, 1235, EV35, EN93	M14F, M14HD, NC14C, TR286, MN1400, PC1400	1C, 614, 814,	14A, 14C, 14D, 14F, 14NC, 1600M
2225	2				
		"D" CELL HOLDERS (BATTERY 1.187 (30.1) O.D. × 2.312 (58.7) L) SIZE 1.375 (34.9) 2.412 (61.3)			
2226	1	CH50, E95, 950, 1250, EV50, EN95	M13F, NC13D, S42, M13HD, TR289, MN1300, PC1300	2D, 6D, 613, 813	13A, 13C, 13D, 13F, 13NC, 1115M, 1810M
2227	2				

STEEL HOLDERS WITH PC LUGS

ELIMINATES WIRING · LABOR SAVING

For printed circuitry we have standardized our most popular holders with PC Lugs. Choice of single or multiple holders. "AA" assembled with Cat. No. 4002 lug. "C" and "D" assembled with Cat. No. 4003 lug. (Refer to page 50)

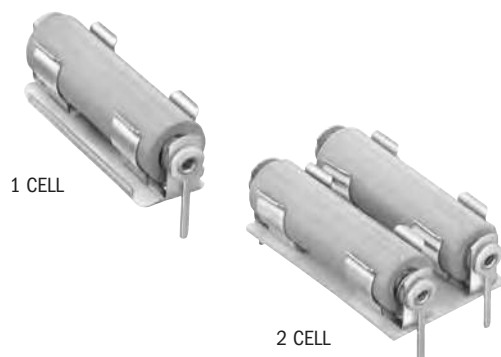

CAT. NO.	HOLDS NO. OF CELLS	BATTERY CROSS REFERENCE			
		EVEREADY	DURACELL	RAY-O-VAC	NEDA
		"AA" CELL HOLDERS (BATTERY .531 (13.4) O.D. × 1.906 (48.4) L) SIZE .565 (14.5) 1.988 (50.5)			
2228	1	E9, EV15, EN91, CH15, E133, E133N, E177, 505, 523, 1015, 1215	ZM9, RM12R, NC15AA, M15F, M15AA, TR133R, TR177, M505, MN1500, PC1500	5AA, 615, 815, 7AA	15, 15A, 15C, 15D, 15F, 15M, 15NC, 221, 1101M, 1113M, 1306AP, 1306M, 1314M, 1606M
2229	2				
		"C" CELL HOLDERS (BATTERY .875 (22.2) O.D. × 1.875 (47.6) L) SIZE 1.125 (28.6) 1.969 (50.0)			
2230	1	CH35, E93, 935, 1235, EV35, EN93	M14F, M14HD, NC14C, TR286, MN1400, PC1400	1C, 614, 814,	14A, 14C, 14D, 14F, 14NC, 1600M
2231	2				
		"D" CELL HOLDERS (BATTERY 1.187 (30.1) O.D. × 2.312 (58.7) L) SIZE 1.375 (34.9) 2.412 (61.3)			
2232	1	CH50, E95, 950, 1250, EV50, EN95	M13F, NC13D, S42, M13HD, TR289, MN1300, PC1300	2D, 6D, 613, 813	13A, 13C, 13D, 13F, 13NC, 1115M, 1810M
2233	2				