

360° ELASTOMER GASKET COMPLIES WITH (SFP) MSA BOARD AND BEZEL LOCATIONS

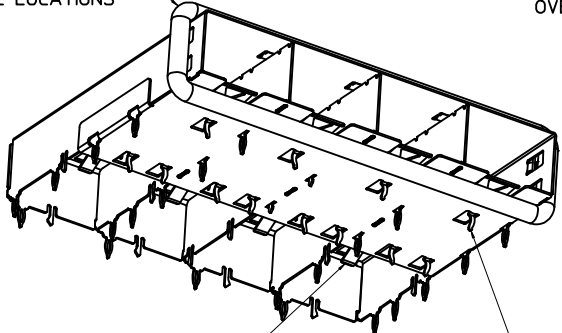

EMI FINGERS CONTACT ADAPTER
12 UNDER BELLY EMI PINS

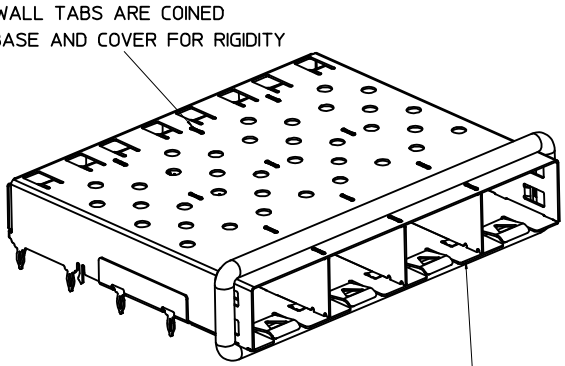

INNER WALL TABS ARE COINED OVER BASE AND COVER FOR RIGIDITY

DIMENSIONS OF EACH INNER CAGE DESIGNED TO FUNCTION WITH SMALL FORM-FACTOR PLUGGABLE (SFP) TRANSCEIVER

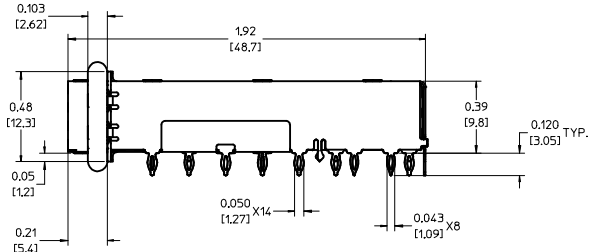

- NOTES:
- PRESS FIT LEGS .120" LONG-
0.062 [1.57] MINIMUM PCB THICKNESS FOR SINGLE SIDED USE.
0.118 [3.00] MINIMUM PCB THICKNESS FOR BELLY TO BELLY USE.
 - MATERIAL: COPPER ALLOY
PLATING: NONE

NOTE: A NICKEL PLATED VERSION OF THIS ASSEMBLY IS AVAILABLE. REFER TO DOCUMENT SD-74728-420.

- REFERENCE DOCUMENTS:
PRODUCT SPECIFICATION: PS-74728-000
COSMETIC SPECIFICATIONS: WI-HP-7-2774 AND WI-HPA-7-0093
TEST SUMMARY: TS-74728-0415
- THIS PART MEETS THE RESTRICTION OF HAZARDOUS SUBSTANCES IN ELECTRICAL AND ELECTRONIC EQUIPMENT (ROHS) DIRECTIVE (2002/95/EC).

ENTER DESCRIPTION EIC NO: USY2006-0079 DRAWN BY: CHYKORUSSELL 2006/01/17 CHECKED BY: APPR:BRUSSELL 2006/01/25 DESCRIPTION	QUALITY SYMBOLS ▽=0 ▽=0		GENERAL TOLERANCES (UNLESS SPECIFIED) mm INCH 4 PLACES ±.005 ±.001 3 PLACES ±.010 ±.005 2 PLACES ±.015 ±.010 1 PLACE ±.025 ±.015 ANGULAR ± 1°		DIMENSION STYLE IN/MM SCALE 3:1 DESIGN UNITS METRIC THIRD ANGLE PROJECTION		DRAWN BY: KSI MONSO 2004/03/22 CHECKED BY: BRUSSELL 2004/03/22 APPROVED BY: BRUSSELL 2004/03/22		DATE: 2004/03/22 DATE: 2004/03/22 DATE: 2004/03/22		TITLE 1X4 SFP GANGED CAGE ASSEMBLY W/ ELASTOMER GASKET, PRESS FIT	
	MATERIAL NO. 739270411		DOCUMENT NO. SD-73927-411		MOLEX INCORPORATED		SHEET NO. 1 OF 5		THIS DRAWING CONTAINS INFORMATION THAT IS PROPRIETARY TO MOLEX INCORPORATED AND SHOULD NOT BE USED WITHOUT WRITTEN PERMISSION		SIZE D	
	DRAFT WHERE APPLICABLE MUST REMAIN WITHIN DIMENSIONS											
	DRAFT WHERE APPLICABLE MUST REMAIN WITHIN DIMENSIONS											

PCB LAYOUT FOR BELLY TO BELLY MOUNTING

CROSS-HATCHED AREA DENOTES
COMPONENT AND TRACE KEEP-OUT
(EXCEPT CHASSIS GROUND)

HOST CONNECTOR DETAIL

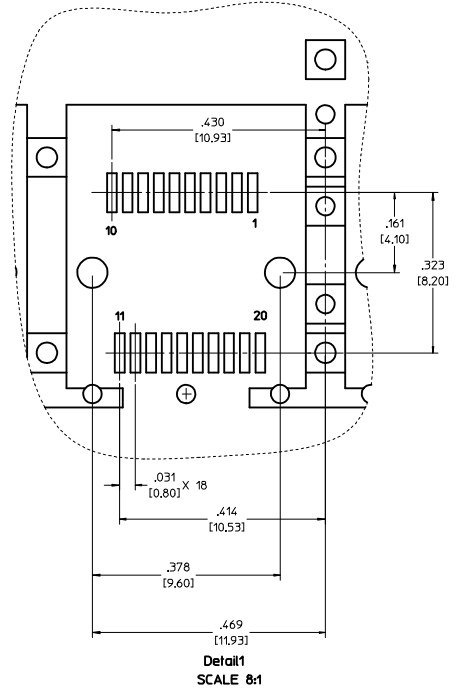
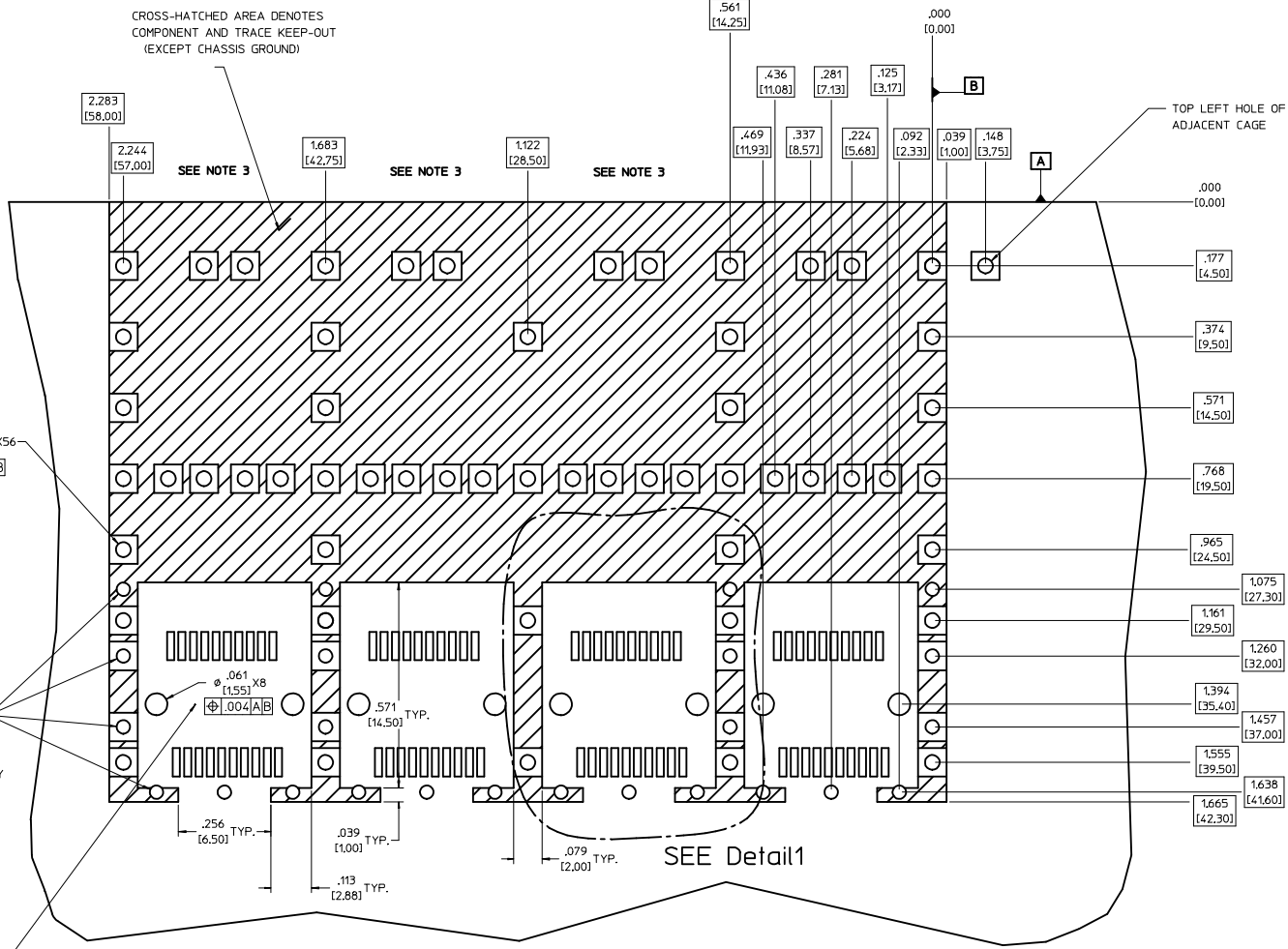

Detail 1
SCALE 8:1

$\phi .041 \pm .002$ X56
[1.05 ± 0.05]
[.004] [A] [B]

$\phi .037 \pm .002$ X24
[0.95 ± 0.05]
[.004] [A] [B]
SMALLER HOLE ON
THESE FOUR ROWS ONLY

THIS AREA DENOTES
COMPONENT KEEP-OUT
(TRACES ALLOWED)

- NOTES:**
- PADS AND VIAS GO TO CHASSIS GROUND. (64 PLACES).
RECOMMENDED PADS TO BE 2mm SQUARE
 - PLATING OPTIONAL FOR THROUGH HOLES. (16 PLACES).
 - RECOMMENDED PLATING INCLUDES HASL, IMERSION (GOLD, SILVER, OR TIN), AND OSP.
 - HOLE PATTERN REPEATS FOR EACH PORT.
SPACING BETWEEN PORTS IS 5.61 [14.25]
 - CONNECTOR PAD LAYOUT PER SFP MSA. WILL ACCOMMODATE MOLEX
CONNECTOR SERIES 74441 OR EQUIVALENT.

SEE Detail 1

ENTER DESCRIPTION EC NO: USY2006-0079 DRAWN BY: CHYKORUSSELL CHECKED BY: APPR:BRUSSELL DATE: 2006/01/20 DATE: 2006/01/25	QUALITY SYMBOLS ▽=0 ▽=0	GENERAL TOLERANCES (UNLESS SPECIFIED)		DIMENSION STYLE IN/MM		SCALE 6:1		DESIGN UNITS METRIC		THIRD ANGLE PROJECTION	
		4 PLACES ±.005 ±.005 3 PLACES ±.013 ±.01 2 PLACES ±.025 ±.025 1 PLACE ±.025 ±.025 ANGULAR ± 1°		DRAWN BY: KSI MONSO CHECKED BY: BRUSSELL APPROVED BY: BRUSSELL DATE: 2004/03/22 DATE: 2004/03/22 DATE: 2004/03/22		TITLE 1X4 SFP GANGED CAGE ASSEMBLY W/ ELASTOMER GASKET, PRESS FIT		MOLEX INCORPORATED		SHEET NO. 2 OF 5	
DRAFT WHERE APPLICABLE MUST REMAIN WITHIN DIMENSIONS		MATERIAL NO. 739270411		DOCUMENT NO. SD-73927-411		THIS DRAWING CONTAINS INFORMATION THAT IS PROPRIETARY TO MOLEX INCORPORATED AND SHOULD NOT BE USED WITHOUT WRITTEN PERMISSION					

PCB LAYOUT FOR SINGLE SIDE MOUNTING

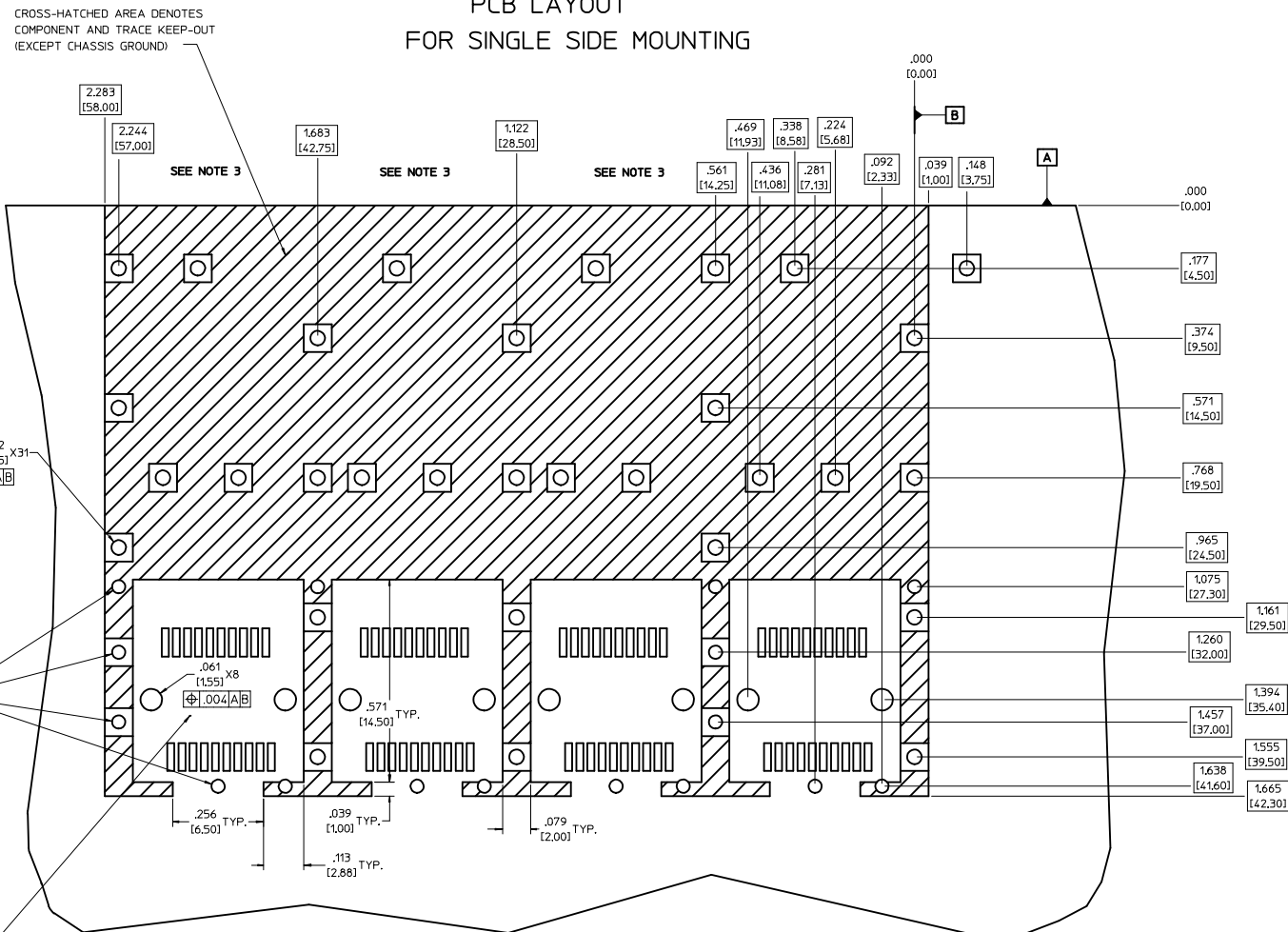

CROSS-HATCHED AREA DENOTES
COMPONENT AND TRACE KEEP-OUT
(EXCEPT CHASSIS GROUND)

SEE NOTE 3

SEE NOTE 3

SEE NOTE 3

$\phi .041 \pm .002$ X31
[1.05 ± 0.05]
[1.004] [A] [B]

$\phi .037 \pm .002$
[0.95 ± 0.05] X16
[1.004] [A] [B]
SMALLER HOLE ON
THESE FOUR ROWS ONLY

THIS AREA DENOTES
COMPONENT KEEP-OUT
(TRACES ALLOWED)

- NOTES:**
- PADS AND VIAS GO TO CHASSIS GROUND. (34 PLACES).
RECOMMENDED PADS TO BE 2mm SQUARE
 - PLATING OPTIONAL FOR THROUGH HOLES. (12 PLACES).
 - RECOMMENDED PLATING INCLUDES HASL, IMMERSION (GOLD, SILVER, OR TIN), AND OSP.
 - HOLE PATTERN REPEATS FOR EACH PORT.
SPACING BETWEEN PORTS IS 5.61 [14.25]
 - CONNECTOR PAD LAYOUT PER SFP MSA. WILL ACCOMMODATE MOLEX
CONNECTOR SERIES 74441 OR EQUIVALENT.

ENTER DESCRIPTION EC NO: USY2006-0079 DRAWN BY: KSI MONSON CHKD BY: BRUSSELL APPR: BRUSSELL DATE: 2006/01/20 DATE: 2006/01/25	QUALITY SYMBOLS 0= 1= 2= 3= 4= 5= 6= 7= 8= 9= 10= 11= 12= 13= 14= 15= 16= 17= 18= 19= 20= 21= 22= 23= 24= 25= 26= 27= 28= 29= 30= 31= 32= 33= 34= 35= 36= 37= 38= 39= 40= 41= 42= 43= 44= 45= 46= 47= 48= 49= 50= 51= 52= 53= 54= 55= 56= 57= 58= 59= 60= 61= 62= 63= 64= 65= 66= 67= 68= 69= 70= 71= 72= 73= 74= 75= 76= 77= 78= 79= 80= 81= 82= 83= 84= 85= 86= 87= 88= 89= 90= 91= 92= 93= 94= 95= 96= 97= 98= 99= 100= 101= 102= 103= 104= 105= 106= 107= 108= 109= 110= 111= 112= 113= 114= 115= 116= 117= 118= 119= 120= 121= 122= 123= 124= 125= 126= 127= 128= 129= 130= 131= 132= 133= 134= 135= 136= 137= 138= 139= 140= 141= 142= 143= 144= 145= 146= 147= 148= 149= 150= 151= 152= 153= 154= 155= 156= 157= 158= 159= 160= 161= 162= 163= 164= 165= 166= 167= 168= 169= 170= 171= 172= 173= 174= 175= 176= 177= 178= 179= 180= 181= 182= 183= 184= 185= 186= 187= 188= 189= 190= 191= 192= 193= 194= 195= 196= 197= 198= 199= 200= 201= 202= 203= 204= 205= 206= 207= 208= 209= 210= 211= 212= 213= 214= 215= 216= 217= 218= 219= 220= 221= 222= 223= 224= 225= 226= 227= 228= 229= 230= 231= 232= 233= 234= 235= 236= 237= 238= 239= 240= 241= 242= 243= 244= 245= 246= 247= 248= 249= 250= 251= 252= 253= 254= 255= 256= 257= 258= 259= 260= 261= 262= 263= 264= 265= 266= 267= 268= 269= 270= 271= 272= 273= 274= 275= 276= 277= 278= 279= 280= 281= 282= 283= 284= 285= 286= 287= 288= 289= 290= 291= 292= 293= 294= 295= 296= 297= 298= 299= 300= 301= 302= 303= 304= 305= 306= 307= 308= 309= 310= 311= 312= 313= 314= 315= 316= 317= 318= 319= 320= 321= 322= 323= 324= 325= 326= 327= 328= 329= 330= 331= 332= 333= 334= 335= 336= 337= 338= 339= 340= 341= 342= 343= 344= 345= 346= 347= 348= 349= 350= 351= 352= 353= 354= 355= 356= 357= 358= 359= 360= 361= 362= 363= 364= 365= 366= 367= 368= 369= 370= 371= 372= 373= 374= 375= 376= 377= 378= 379= 380= 381= 382= 383= 384= 385= 386= 387= 388= 389= 390= 391= 392= 393= 394= 395= 396= 397= 398= 399= 400= 401= 402= 403= 404= 405= 406= 407= 408= 409= 410= 411= 412= 413= 414= 415= 416= 417= 418= 419= 420= 421= 422= 423= 424= 425= 426= 427= 428= 429= 430= 431= 432= 433= 434= 435= 436= 437= 438= 439= 440= 441= 442= 443= 444= 445= 446= 447= 448= 449= 450= 451= 452= 453= 454= 455= 456= 457= 458= 459= 460= 461= 462= 463= 464= 465= 466= 467= 468= 469= 470= 471= 472= 473= 474= 475= 476= 477= 478= 479= 480= 481= 482= 483= 484= 485= 486= 487= 488= 489= 490= 491= 492= 493= 494= 495= 496= 497= 498= 499= 500= 501= 502= 503= 504= 505= 506= 507= 508= 509= 510= 511= 512= 513= 514= 515= 516= 517= 518= 519= 520= 521= 522= 523= 524= 525= 526= 527= 528= 529= 530= 531= 532= 533= 534= 535= 536= 537= 538= 539= 540= 541= 542= 543= 544= 545= 546= 547= 548= 549= 550= 551= 552= 553= 554= 555= 556= 557= 558= 559= 560= 561= 562= 563= 564= 565= 566= 567= 568= 569= 570= 571= 572= 573= 574= 575= 576= 577= 578= 579= 580= 581= 582= 583= 584= 585= 586= 587= 588= 589= 590= 591= 592= 593= 594= 595= 596= 597= 598= 599= 600= 601= 602= 603= 604= 605= 606= 607= 608= 609= 610= 611= 612= 613= 614= 615= 616= 617= 618= 619= 620= 621= 622= 623= 624= 625= 626= 627= 628= 629= 630= 631= 632= 633= 634= 635= 636= 637= 638= 639= 640= 641= 642= 643= 644= 645= 646= 647= 648= 649= 650= 651= 652= 653= 654= 655= 656= 657= 658= 659= 660= 661= 662= 663= 664= 665= 666= 667= 668= 669= 670= 671= 672= 673= 674= 675= 676= 677= 678= 679= 680= 681= 682= 683= 684= 685= 686= 687= 688= 689= 690= 691= 692= 693= 694= 695= 696= 697= 698= 699= 700= 701= 702= 703= 704= 705= 706= 707= 708= 709= 710= 711= 712= 713= 714= 715= 716= 717= 718= 719= 720= 721= 722= 723= 724= 725= 726= 727= 728= 729= 730= 731= 732= 733= 734= 735= 736= 737= 738= 739= 740= 741= 742= 743= 744= 745= 746= 747= 748= 749= 750= 751= 752= 753= 754= 755= 756= 757= 758= 759= 760= 761= 762= 763= 764= 765= 766= 767= 768= 769= 770= 771= 772= 773= 774= 775= 776= 777= 778= 779= 780= 781= 782= 783= 784= 785= 786= 787= 788= 789= 790= 791= 792= 793= 794= 795= 796= 797= 798= 799= 800= 801= 802= 803= 804= 805= 806= 807= 808= 809= 810= 811= 812= 813= 814= 815= 816= 817= 818= 819= 820= 821= 822= 823= 824= 825= 826= 827= 828= 829= 830= 831= 832= 833= 834= 835= 836= 837= 838= 839= 840= 841= 842= 843= 844= 845= 846= 847= 848= 849= 850= 851= 852= 853= 854= 855= 856= 857= 858= 859= 860= 861= 862= 863= 864= 865= 866= 867= 868= 869= 870= 871= 872= 873= 874= 875= 876= 877= 878= 879= 880= 881= 882= 883= 884= 885= 886= 887= 888= 889= 890= 891= 892= 893= 894= 895= 896= 897= 898= 899= 900= 901= 902= 903= 904= 905= 906= 907= 908= 909= 910= 911= 912= 913= 914= 915= 916= 917= 918= 919= 920= 921= 922= 923= 924= 925= 926= 927= 928= 929= 930= 931= 932= 933= 934= 935= 936= 937= 938= 939= 940= 941= 942= 943= 944= 945= 946= 947= 948= 949= 950= 951= 952= 953= 954= 955= 956= 957= 958= 959= 960= 961= 962= 963= 964= 965= 966= 967= 968= 969= 970= 971= 972= 973= 974= 975= 976= 977= 978= 979= 980= 981= 982= 983= 984= 985= 986= 987= 988= 989= 990= 991= 992= 993= 994= 995= 996= 997= 998= 999= 1000= 1001= 1002= 1003= 1004= 1005= 1006= 1007= 1008= 1009= 1010= 1011= 1012= 1013= 1014= 1015= 1016= 1017= 1018= 1019= 1020= 1021= 1022= 1023= 1024= 1025= 1026= 1027= 1028= 1029= 1030= 1031= 1032= 1033= 1034= 1035= 1036= 1037= 1038= 1039= 1040= 1041= 1042= 1043= 1044= 1045= 1046= 1047= 1048= 1049= 1050= 1051= 1052= 1053= 1054= 1055= 1056= 1057= 1058= 1059= 1060= 1061= 1062= 1063= 1064= 1065= 1066= 1067= 1068= 1069= 1070= 1071= 1072= 1073= 1074= 1075= 1076= 1077= 1078= 1079= 1080= 1081= 1082= 1083= 1084= 1085= 1086= 1087= 1088= 1089= 1090= 1091= 1092= 1093= 1094= 1095= 1096= 1097= 1098= 1099= 1100= 1101= 1102= 1103= 1104= 1105= 1106= 1107= 1108= 1109= 1110= 1111= 1112= 1113= 1114= 1115= 1116= 1117= 1118= 1119= 1120= 1121= 1122= 1123= 1124= 1125= 1126= 1127= 1128= 1129= 1130= 1131= 1132= 1133= 1134= 1135= 1136= 1137= 1138= 1139= 1140= 1141= 1142= 1143= 1144= 1145= 1146= 1147= 1148= 1149= 1150= 1151= 1152= 1153= 1154= 1155= 1156= 1157= 1158= 1159= 1160= 1161= 1162= 1163= 1164= 1165= 1166= 1167= 1168= 1169= 1170= 1171= 1172= 1173= 1174= 1175= 1176= 1177= 1178= 1179= 1180= 1181= 1182= 1183= 1184= 1185= 1186= 1187= 1188= 1189= 1190= 1191= 1192= 1193= 1194= 1195= 1196= 1197= 1198= 1199= 1200= 1201= 1202= 1203= 1204= 1205= 1206= 1207= 1208= 1209= 1210= 1211= 1212= 1213= 1214= 1215= 1216= 1217= 1218= 1219= 1220= 1221= 1222= 1223= 1224= 1225=
--	--

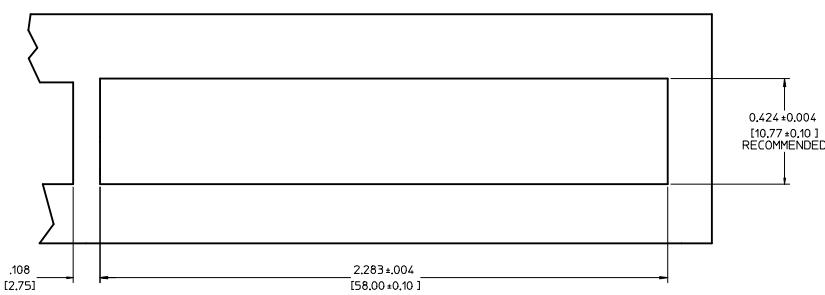

BEZEL AND BOARD POSITION DIMENSIONS FOR SINGLE SIDE MOUNTING

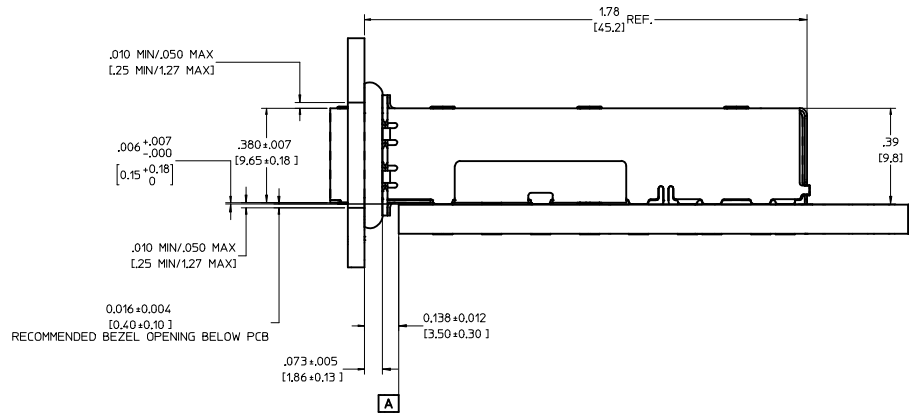

BEZEL AND BOARD POSITION DIMENSIONS FOR BELLY TO BELLY MOUNTING

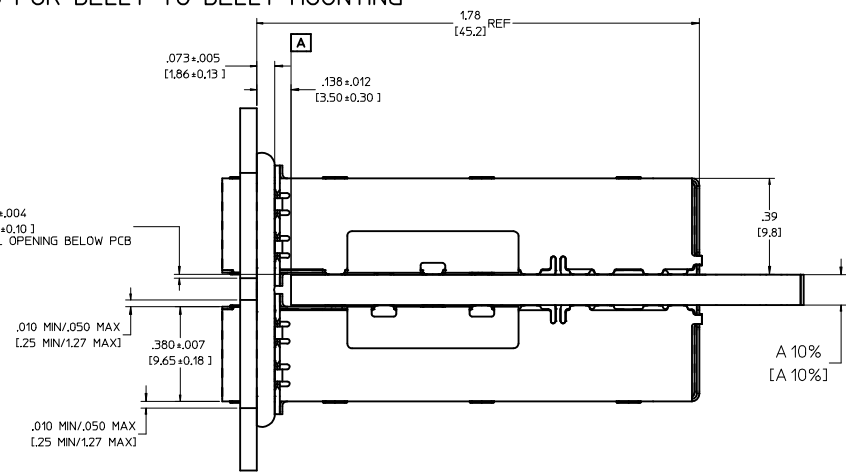
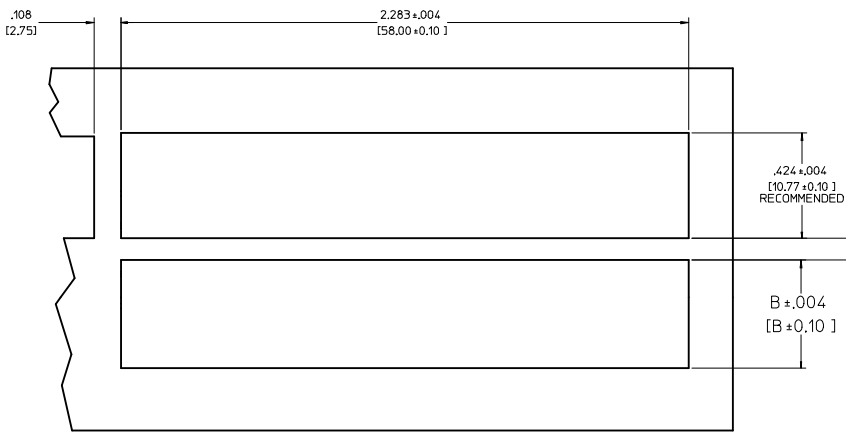

NOTE: FOR A GIVEN BOARD THICKNESS (A), DIMENSIONS (B) AND (C) ARE DIRECTLY AFFECTED.

USE RECOMMENDED DIMENSIONS AND TOLERANCES TO AID IN DEVELOPING BEZEL OPENING.

FOR EXAMPLE USING A BOARD THICKNESS OF .125" THE RECOMMENDED VALUES WOULD BE:

A= .125/3.18 ±10%
 B= .434/11.03 ±.004
 C= .088/2.23 ±.004

ENTER DESCRIPTION EC NO: USY2006-0079 DRAWN BY: KSI MONSO CHKD: BRUSSELL APPR: BRUSSELL DATE: 2006/01/25	QUALITY SYMBOLS	GENERAL TOLERANCES (UNLESS SPECIFIED)	DIMENSION STYLE	SCALE	DESIGN UNITS	THIRD ANGLE PROJECTION
	▽=0 ▽=0	4 PLACES ±--- INCH 3 PLACES ±--- INCH 2 PLACES ±0.13 INCH 1 PLACE ±0.25 INCH	IN/MM	4:1	METRIC	DRAWN BY: KSI MONSO CHECKED BY: BRUSSELL APPROVED BY: BRUSSELL DATE: 2004/03/22 DATE: 2004/03/22 DATE: 2004/03/22
	DRAFT WHERE APPLICABLE MUST REMAIN WITHIN DIMENSIONS	MATERIAL NO. 739270411 DOCUMENT NO. SD-73927-411	TITLE: 1X4 SFP GANGED CAGE ASSEMBLY W/ ELASTOMER GASKET, PRESS FIT MOLEX INCORPORATED	SHEET NO. 4 OF 5		
	THIS DRAWING CONTAINS INFORMATION THAT IS PROPRIETARY TO MOLEX INCORPORATED AND SHOULD NOT BE USED WITHOUT WRITTEN PERMISSION					

20 19 18 17 16 15 14 13 12 11 10 9 8 7 6 5 4 3 2 1

DATE	REV	CHANGES	COMMENTS
11/01/2003	1	PRELIMINARY DOCUMENT	N/A
03/08/2004	A	INITIAL RELEASE	N/A
10/09/2004	B	UPDATED VIEWS	DOCUMENT CHANGE ONLY
10/07/2005	C	ADDED PCB AND BEZEL LAYOUT. UPDATED NOTES.	DOCUMENT CHANGE ONLY

ENTER DESCRIPTION EC NO: USY2006-0079 DRAWN BY: SIMONSON 2006/01/17 CHECKED BY: CHYKORUSSELL 2006/01/20 APPROVED BY: BRUSSELL 2006/01/25	QUALITY SYMBOLS ▽=0 ▽=0	GENERAL TOLERANCES (UNLESS SPECIFIED)		DIMENSION STYLE IN/MM	SCALE 1:1	DESIGN UNITS METRIC	THIRD ANGLE PROJECTION
		4 PLACES ±--- ±--- 3 PLACES ±--- ±.005 2 PLACES ±0.13 ±.01 1 PLACE ±0.25 ±--- ANGULAR ± 1°	DRAWN BY: SIMONSON 2004/03/22 CHECKED BY: BRUSSELL 2004/03/22 APPROVED BY: BRUSSELL 2004/03/22	TITLE 1X4 SFP GANGED CAGE ASSEMBLY W/ ELASTOMER GASKET, PRESS FIT		MATERIAL NO. 739270411	
DRAFT WHERE APPLICABLE MUST REMAIN WITHIN DIMENSIONS		THIS DRAWING CONTAINS INFORMATION THAT IS PROPRIETARY TO MOLEX INCORPORATED AND SHOULD NOT BE USED WITHOUT WRITTEN PERMISSION					

19 18 17 16 15 14 13 12 11 10 9 8 7 6 5 4 3 2 1

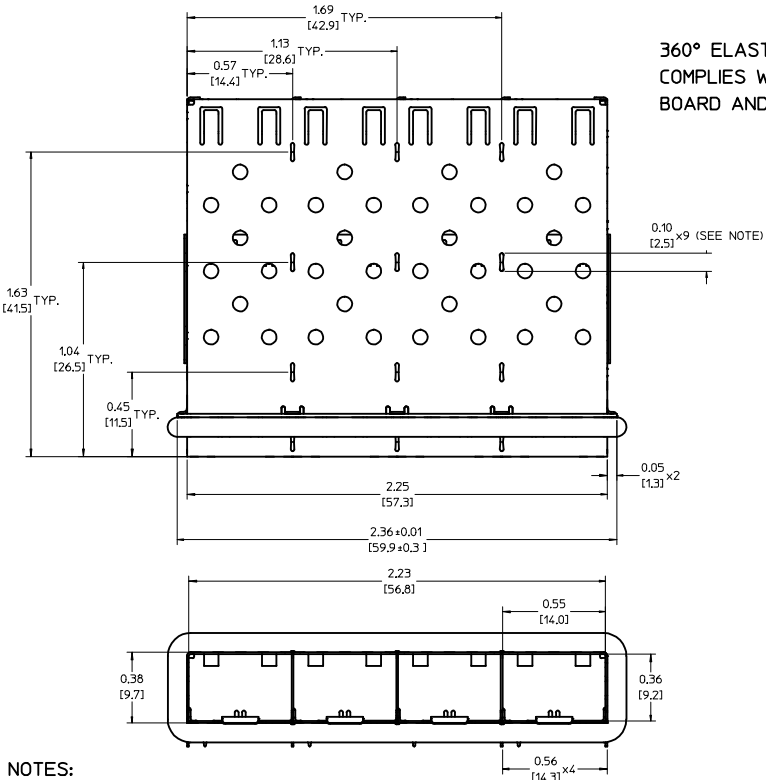

360° ELASTOMER GASKET COMPLIES WITH (SFP) MSA BOARD AND BEZEL LOCATIONS

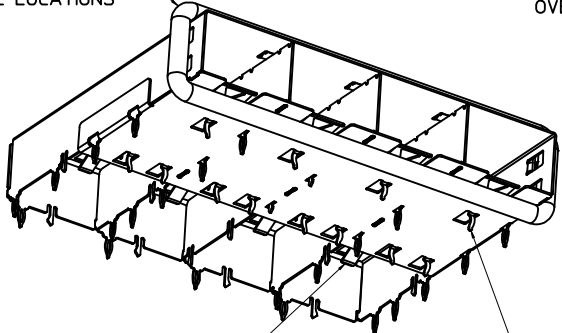

EMI FINGERS CONTACT ADAPTER
12 UNDER BELLY EMI PINS

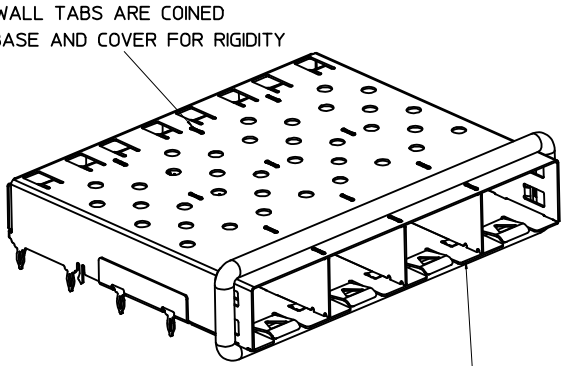

INNER WALL TABS ARE COINED OVER BASE AND COVER FOR RIGIDITY

DIMENSIONS OF EACH INNER CAGE DESIGNED TO FUNCTION WITH SMALL FORM-FACTOR PLUGGABLE (SFP) TRANSCEIVER

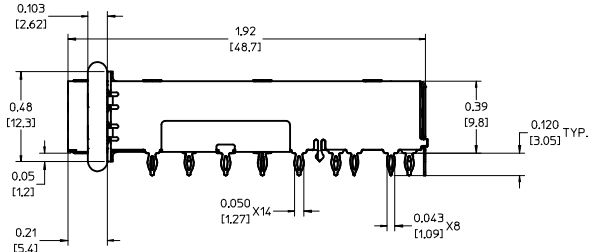

NOTES:

1. PRESS FIT LEGS .120" LONG-
0.062 [1.57] MINIMUM PCB THICKNESS FOR SINGLE SIDED USE.
0.118 [3.00] MINIMUM PCB THICKNESS FOR BELLY TO BELLY USE.

2. MATERIAL: COPPER ALLOY
PLATING: NONE

NOTE: A NICKEL PLATED VERSION OF THIS ASSEMBLY IS AVAILABLE.
REFER TO DOCUMENT SD-74728-420.

3. REFERENCE DOCUMENTS:
PRODUCT SPECIFICATION: PS-74728-000
COSMETIC SPECIFICATIONS: WI-HP-7-2774 AND WI-HPA-7-0093
TEST SUMMARY: TS-74728-0415

4. THIS PART MEETS THE RESTRICTION OF HAZARDOUS SUBSTANCES IN ELECTRICAL AND ELECTRONIC EQUIPMENT (ROHS) DIRECTIVE (2002/95/EC).

ENTER DESCRIPTION EIC NO: USY2006-0079 DRAWN BY: CHYKORUSSELL 2006/01/17 CHECKED BY: APPR:BRUSSELL 2006/01/25 DESCRIPTION	QUALITY SYMBOLS ▽=0 ▽=0		GENERAL TOLERANCES (UNLESS SPECIFIED) mm INCH 4 PLACES ±.005 ±.005 3 PLACES ±.01 ±.01 2 PLACES ±.015 ±.015 1 PLACE ±.025 ±.025 ANGULAR ± 1°		DIMENSION STYLE IN/MM SCALE 3:1 DESIGN UNITS METRIC THIRD ANGLE PROJECTION		DRAWN BY: KSI MONSO 2004/03/22 DATE CHECKED BY: BRUSSELL 2004/03/22 DATE APPROVED BY: BRUSSELL 2004/03/22 DATE		TITLE 1X4 SFP GANGED CAGE ASSEMBLY W/ ELASTOMER GASKET, PRESS FIT	
	MATERIAL NO. 739270411		DOCUMENT NO. SD-73927-411		MOLEX INCORPORATED		SHEET NO. 1 OF 5			
	DRAFT WHERE APPLICABLE MUST REMAIN WITHIN DIMENSIONS								THIS DRAWING CONTAINS INFORMATION THAT IS PROPRIETARY TO MOLEX INCORPORATED AND SHOULD NOT BE USED WITHOUT WRITTEN PERMISSION	
	SIZE D									

PCB LAYOUT FOR BELLY TO BELLY MOUNTING

CROSS-HATCHED AREA DENOTES
COMPONENT AND TRACE KEEP-OUT
(EXCEPT CHASSIS GROUND)

HOST CONNECTOR DETAIL

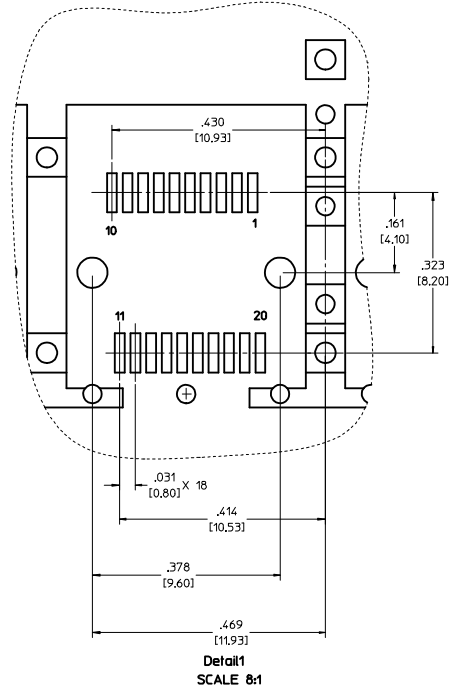
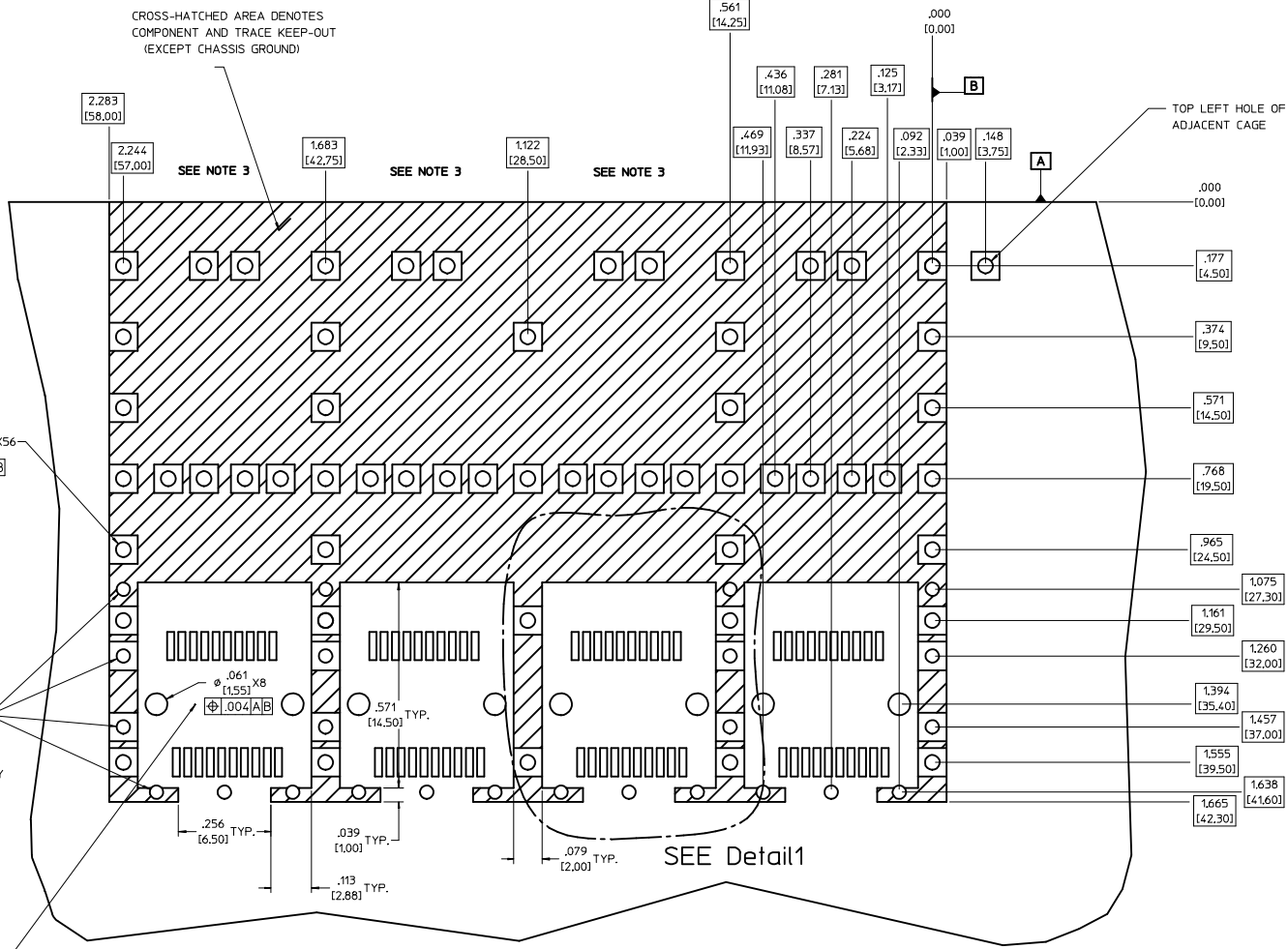

Detail 1
SCALE 8:1

$\phi .041 \pm .002$ X56
[1.05 ± 0.05]
[.004] [A] [B]

$\phi .037 \pm .002$ X24
[0.95 ± 0.05]
[.004] [A] [B]
SMALLER HOLE ON
THESE FOUR ROWS ONLY

THIS AREA DENOTES
COMPONENT KEEP-OUT
(TRACES ALLOWED)

- NOTES:**
- PADS AND VIAS GO TO CHASSIS GROUND. (64 PLACES).
RECOMMENDED PADS TO BE 2mm SQUARE
 - PLATING OPTIONAL FOR THROUGH HOLES. (16 PLACES).
 - RECOMMENDED PLATING INCLUDES HASL, IMERSION (GOLD, SILVER, OR TIN), AND OSP.
 - HOLE PATTERN REPEATS FOR EACH PORT.
SPACING BETWEEN PORTS IS 5.61 [14.25]
 - CONNECTOR PAD LAYOUT PER SFP MSA. WILL ACCOMMODATE MOLEX
CONNECTOR SERIES 74441 OR EQUIVALENT.

SEE Detail1

ENTER DESCRIPTION EC NO: USY2006-0079 DRAWN BY: CHYKORUSSELL CHECKED BY: APPR:BRUSSELL DATE: 2006/01/20 DATE: 2006/01/25	QUALITY SYMBOLS ▽=0 ▽=0	GENERAL TOLERANCES (UNLESS SPECIFIED)		DIMENSION STYLE IN/MM		SCALE 6:1	DESIGN UNITS METRIC	THIRD ANGLE PROJECTION
		4 PLACES ±.005 ±.005 3 PLACES ±.013 ±.01 2 PLACES ±.025 ±.025 1 PLACE ±.025 ±.025 ANGULAR ± 1°	DRAWN BY: KSI MONSO DATE: 2004/03/22 CHECKED BY: BRUSSELL DATE: 2004/03/22 APPROVED BY: BRUSSELL DATE: 2004/03/22	TITLE 1X4 SFP GANGED CAGE ASSEMBLY W/ ELASTOMER GASKET, PRESS FIT			MOLEX INCORPORATED	
DRAFT WHERE APPLICABLE MUST REMAIN WITHIN DIMENSIONS		MATERIAL NO. 739270411		DOCUMENT NO. SD-73927-411		THIS DRAWING CONTAINS INFORMATION THAT IS PROPRIETARY TO MOLEX INCORPORATED AND SHOULD NOT BE USED WITHOUT WRITTEN PERMISSION		

PCB LAYOUT FOR SINGLE SIDE MOUNTING

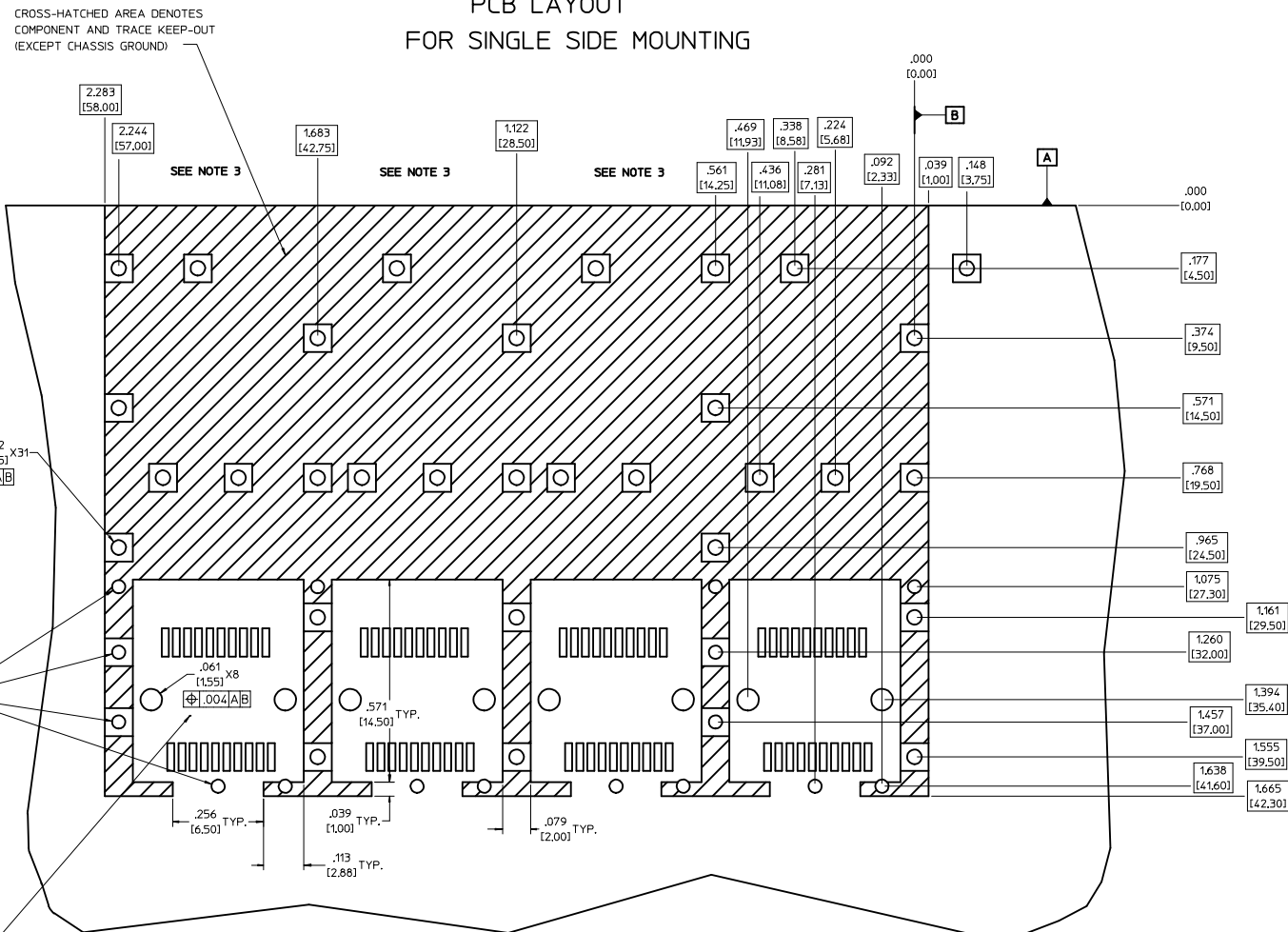

CROSS-HATCHED AREA DENOTES
COMPONENT AND TRACE KEEP-OUT
(EXCEPT CHASSIS GROUND)

SEE NOTE 3

SEE NOTE 3

SEE NOTE 3

$\phi .041 \pm .002$
[1.05 ± 0.05] X31
 $\phi 1.004$ [A] [B]

$\phi .037 \pm .002$
[0.95 ± 0.05] X16
 $\phi 1.004$ [A] [B]
SMALLER HOLE ON
THESE FOUR ROWS ONLY

THIS AREA DENOTES
COMPONENT KEEP-OUT
(TRACES ALLOWED)

- NOTES:**
- PADS AND VIAS GO TO CHASSIS GROUND. (34 PLACES).
RECOMMENDED PADS TO BE 2mm SQUARE
 - PLATING OPTIONAL FOR THROUGH HOLES. (12 PLACES).
 - RECOMMENDED PLATING INCLUDES HASL, IMMERSION (GOLD, SILVER, OR TIN), AND OSP.
 - HOLE PATTERN REPEATS FOR EACH PORT.
SPACING BETWEEN PORTS IS 5.61 [14.25]
 - CONNECTOR PAD LAYOUT PER SFP MSA. WILL ACCOMMODATE MOLEX
CONNECTOR SERIES 74441 OR EQUIVALENT.

ENTER DESCRIPTION EC NO: USY2006-0079 DRAWN BY: KSI MONSON CHKD BY: BRUSSELL APPR: BRUSSELL DATE: 2006/01/20 DATE: 2006/01/25	QUALITY SYMBOLS =0 =0	GENERAL TOLERANCES (UNLESS SPECIFIED)		DIMENSION STYLE IN/MM	SCALE 6:1	DESIGN UNITS METRIC	THIRD ANGLE PROJECTION		
		4 PLACES ± --- ± --- 3 PLACES ± --- ± .005 2 PLACES ± .13 ± .01 1 PLACE ± 0.25 ± ---	mm INCH	DRAWN BY: KSI MONSON DATE: 2004/03/22	CHECKED BY: BRUSSELL DATE: 2004/03/22	TITLE 1X4 SFP GANGED CAGE ASSEMBLY W/ ELASTOMER GASKET, PRESS FIT			
		ANGULAR ± 1°		APPROVED BY: BRUSSELL DATE: 2004/03/22	MOLEX INCORPORATED				
		DRAFT WHERE APPLICABLE MUST REMAIN WITHIN DIMENSIONS		MATERIAL NO: 739270411	DOCUMENT NO: SD-73927-411	SHEET NO. 3 OF 5			

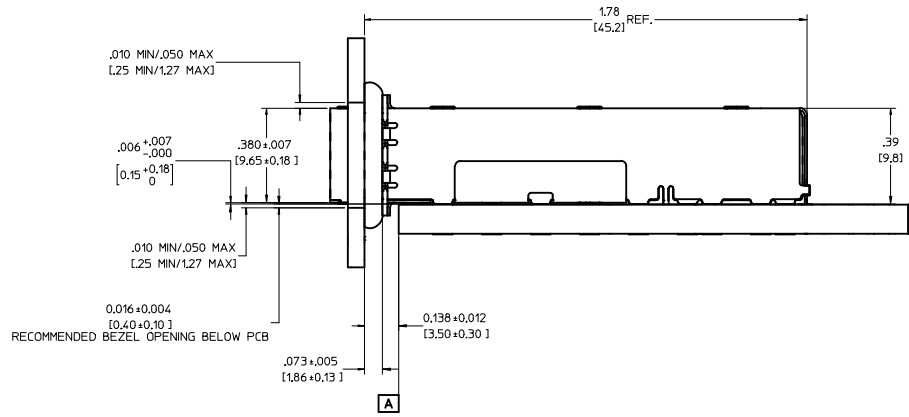
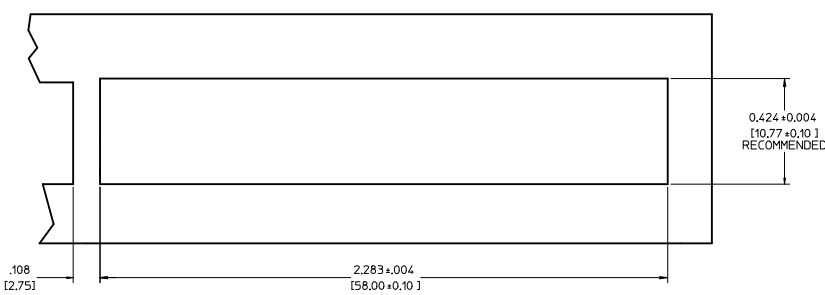

BEZEL AND BOARD POSITION DIMENSIONS FOR SINGLE SIDE MOUNTING

BEZEL AND BOARD POSITION DIMENSIONS FOR BELLY TO BELLY MOUNTING

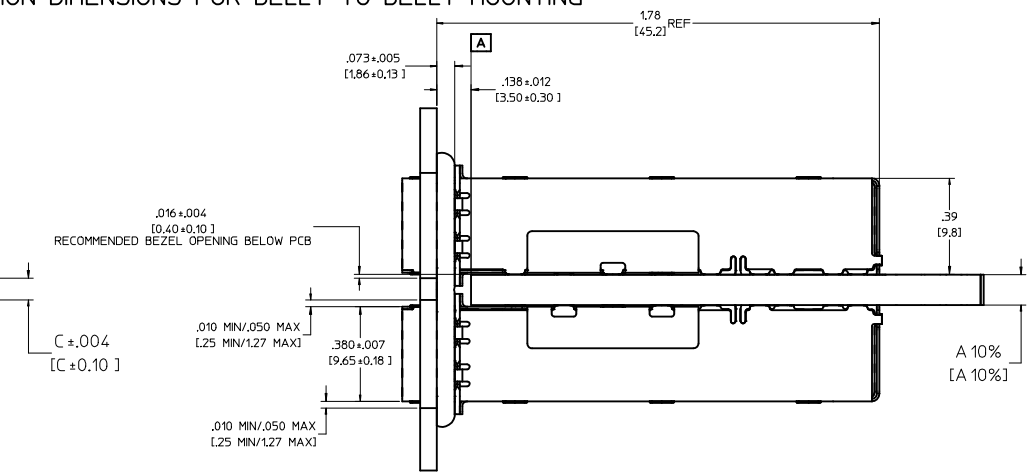
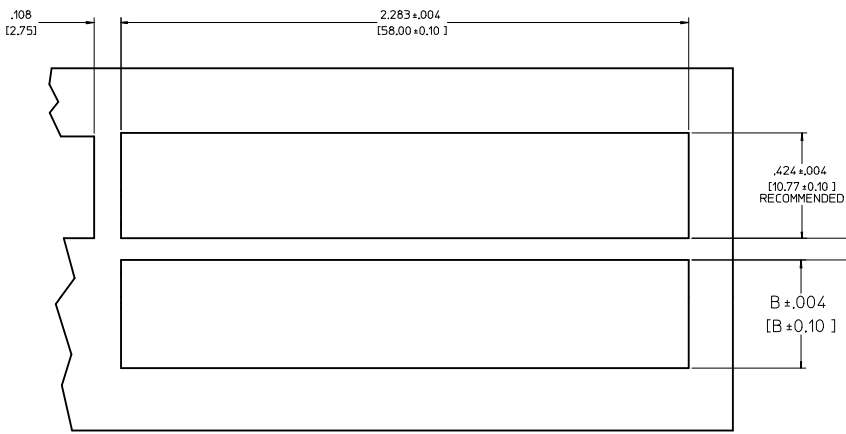

NOTE: FOR A GIVEN BOARD THICKNESS (A), DIMENSIONS (B) AND (C) ARE DIRECTLY AFFECTED.

USE RECOMMENDED DIMENSIONS AND TOLERANCES TO AID IN DEVELOPING BEZEL OPENING.

FOR EXAMPLE USING A BOARD THICKNESS OF .125" THE RECOMMENDED VALUES WOULD BE:

A= .125/3.18 ±10%
 B= .434/11.03 ±.004
 C= .088/2.23 ±.004

ENTER DESCRIPTION EC NO: USY2006-0079 DRAWN BY: KSI MONSO CHKD: BRUSSELL APPR: BRUSSELL DATE: 2006/01/25	QUALITY SYMBOLS	GENERAL TOLERANCES (UNLESS SPECIFIED)	DIMENSION STYLE	SCALE	DESIGN UNITS	THIRD ANGLE PROJECTION
	▽=0 ▽=0	4 PLACES ±--- INCH 3 PLACES ±--- INCH 2 PLACES ±0.13 INCH 1 PLACE ±0.25 INCH	IN/MM	4:1	METRIC	DRAWN BY: KSI MONSO CHECKED BY: BRUSSELL APPROVED BY: BRUSSELL DATE: 2004/03/22 DATE: 2004/03/22 DATE: 2004/03/22
	DRAFT WHERE APPLICABLE MUST REMAIN WITHIN DIMENSIONS	MATERIAL NO. 739270411 DOCUMENT NO. SD-73927-411	TITLE: 1X4 SFP GANGED CAGE ASSEMBLY W/ ELASTOMER GASKET, PRESS FIT MOLEX INCORPORATED	SHEET NO. 4 OF 5		
	THIS DRAWING CONTAINS INFORMATION THAT IS PROPRIETARY TO MOLEX INCORPORATED AND SHOULD NOT BE USED WITHOUT WRITTEN PERMISSION					

20 19 18 17 16 15 14 13 12 11 10 9 8 7 6 5 4 3 2 1

DATE	REV	CHANGES	COMMENTS
11/01/2003	1	PRELIMINARY DOCUMENT	N/A
03/08/2004	A	INITIAL RELEASE	N/A
10/09/2004	B	UPDATED VIEWS	DOCUMENT CHANGE ONLY
10/07/2005	C	ADDED PCB AND BEZEL LAYOUT. UPDATED NOTES.	DOCUMENT CHANGE ONLY

ENTER DESCRIPTION EC NO: USY2006-0079 DRAWN BY: DRANKS IMONSON 2006/01/17 CHECKED BY: CHYD BRUSSELL 2006/01/20 APPROVED BY: APPR: BRUSSELL 2006/01/25	QUALITY SYMBOLS ▽=0 ▽=0	GENERAL TOLERANCES (UNLESS SPECIFIED)		DIMENSION STYLE IN/MM	SCALE 1:1	DESIGN UNITS METRIC	THIRD ANGLE PROJECTION
		4 PLACES ±--- ±--- 3 PLACES ±--- ±.005 2 PLACES ±0.13 ±.01 1 PLACE ±0.25 ±--- ANGULAR ± 1°	DRAWN BY: KS IMONSON 2004/03/22 CHECKED BY: BRUSSELL 2004/03/22 APPROVED BY: BRUSSELL 2004/03/22	TITLE 1X4 SFP GANGED CAGE ASSEMBLY W/ ELASTOMER GASKET, PRESS FIT		MATERIAL NO. 739270411	
DRAFT WHERE APPLICABLE MUST REMAIN WITHIN DIMENSIONS		THIS DRAWING CONTAINS INFORMATION THAT IS PROPRIETARY TO MOLEX INCORPORATED AND SHOULD NOT BE USED WITHOUT WRITTEN PERMISSION					

19 18 17 16 15 14 13 12 11 10 9 8 7 6 5 4 3 2 1