

## Peak Emission Wavelength: 850nm

The 850nm high power infrared LED Series is designed for application requiring high accuracy and precision as well as uniform spectral emission. Custom package solutions and sorting are available.

### FEATURES

- > Hermetically Sealed TO-18
- > High Output Power
- > Gold Plated Dome Lens
- > Narrow Beam Angle / High Reliability

### APPLICATIONS

- > Optical Scanning
- > Linear & Rotary Encoder
- > Edge Sensing / Optical Sensors
- > Optical Switches / Security Systems



## Absolute Maximum Ratings (Ta=25°C)



ITEMS	SYMBOL	RATINGS	UNIT
Forward Current (DC)	IF	100	mA
Forward Current (Pulse)*1	IFP	1	A
Reverse Voltage	VR	5	V
Power Dissipation	PD	200	mW
Operating Temperature Range	Topr	-20 ~ +85	°C
Storage Temperature Range	Tstg	-30 ~ +100	°C
Junction Temperature	Tj	260	°C

\*1: Tw=10μsec, T=10msec.

## Electrical & Optical Characteristics (Ta = 25°C)

ITEMS	SYMBOL	CONDITIONS	MIN	TYP	MAX	UNIT
Power Output	PO	IF=50mA	--	6.0	--	mW
Forward Voltage	VF	IF=50mA	--	1.5	2.0	V
Reverse Current	IR	VR=5V	--	--	10	μA
Peak Emission Wavelength	λp	IF=50mA	--	850	--	nm
Spectral Line Half Width	Δλ	IF=50mA	--	45	--	nm
Half Intensity Beam Angle	Θ	IF=50mA	--	±3	--	deg
Switching Time	tr, tf	IF=50mA	--	40, 30	--	ns

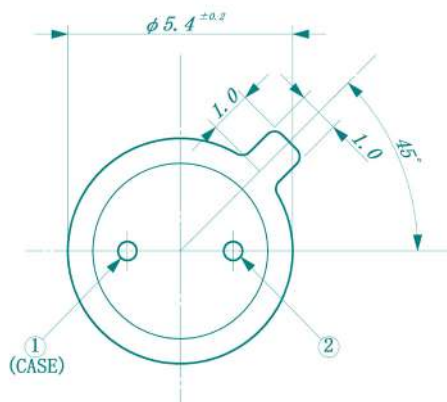
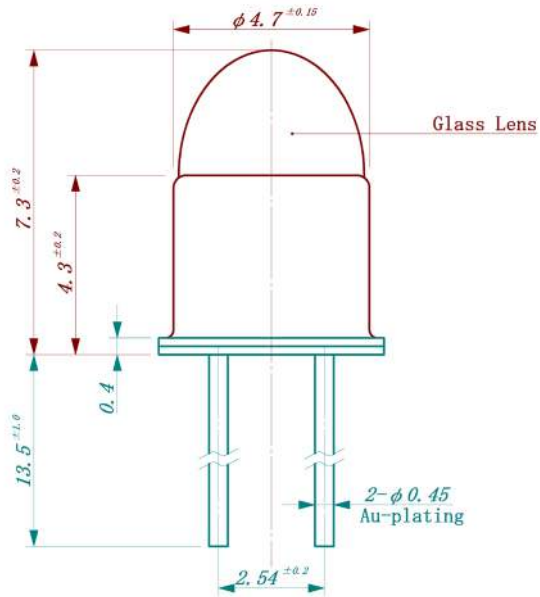

Unit: mm, Tolerance: ±0.2

The information contained herein is subject to change without notice.

2015-05-07