



SC70, 1.6V, Nanopower, Beyond-the-Rails Comparators With/Without Reference

MAX9117-MAX9120

General Description

The MAX9117–MAX9120 nanopower comparators in space-saving SC70 packages feature Beyond-the-Rails™ inputs and are guaranteed to operate down to +1.6V. The MAX9117/MAX9118 feature an on-board 1.252V \pm 1.75% reference and draw an ultra-low supply current of only 600nA, while the MAX9119/MAX9120 (without reference) require just 350nA of supply current. These features make the MAX9117–MAX9120 family of comparators ideal for all 2-cell battery-monitoring/management applications.

The unique design of the output stage limits supply-current surges while switching, virtually eliminating the supply glitches typical of many other comparators. This design also minimizes overall power consumption under dynamic conditions. The MAX9117/MAX9119 have a push-pull output stage that sinks and sources current. Large internal-output drivers allow rail-to-rail output swing with loads up to 5mA. The MAX9118/MAX9120 have an open-drain output stage that makes them suitable for mixed-voltage system design. All devices are available in the ultra-small 5-pin SC70 package.

Applications

2-Cell Battery Monitoring/Management
 Ultra-Low-Power Systems
 Mobile Communications
 Notebooks and PDAs
 Threshold Detectors/Discriminators
 Sensing at Ground or Supply Line
 Telemetry and Remote Systems
 Medical Instruments

Selector Guide

PART	INTERNAL REFERENCE	OUTPUT TYPE	SUPPLY CURRENT (nA)
MAX9117	Yes	Push-Pull	600
MAX9118	Yes	Open-Drain	600
MAX9119	No	Push-Pull	350
MAX9120	No	Open-Drain	350

Typical Application Circuit appears at end of data sheet.

Beyond-the-Rails is a trademark of Maxim Integrated Products, Inc.

Features

- ◆ Space-Saving SC70 Package (Half the Size of SOT23)
- ◆ Ultra-Low Supply Current
 350nA Per Comparator (MAX9119/MAX9120)
 600nA Per Comparator with Reference (MAX9117/MAX9118)
- ◆ Guaranteed to Operate Down to +1.6V
- ◆ Internal 1.252V \pm 1.75% Reference (MAX9117/MAX9118)
- ◆ Input Voltage Range Extends 200mV Beyond-the-Rails
- ◆ CMOS Push-Pull Output with \pm 5mA Drive Capability (MAX9117/MAX9119)
- ◆ Open-Drain Output Versions Available (MAX9118/MAX9120)
- ◆ Crowbar-Current-Free Switching
- ◆ Internal Hysteresis for Clean Switching
- ◆ No Phase Reversal for Overdriven Inputs

Ordering Information

PART	PIN-PACKAGE	TOP MARK	PKG CODE
MAX9117EXK-T	5 SC70-5	ABW	X5-1
MAX9117ESA+	8 SO	—	S8-2
MAX9118EXK-T	5 SC70-5	ABX	X5-1
MAX9119EXK-T	5 SC70-5	ABY	X5-1
MAX9120EXK-T	5 SC70-5	ABZ	X5-1
MAX9120ESA+	8 SO	—	S8-2

Note: All devices specified for over -40°C to +85°C operating temperature range.

+Denotes lead-free package.

Pin Configurations

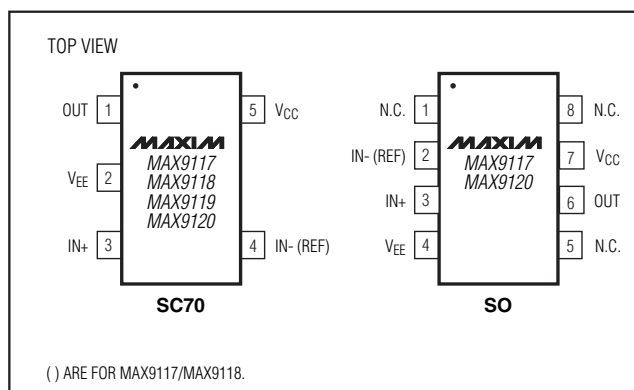

SC70, 1.6V, Nanopower, Beyond-the-Rails Comparators With/Without Reference

ABSOLUTE MAXIMUM RATINGS

Supply Voltage (V _{CC} to V _{EE}).....	+6V
Voltage Inputs (IN+, IN-, REF)	(V _{EE} - 0.3V) to (V _{CC} + 0.3V)
Output Voltage	
MAX9117/MAX9119	(V _{EE} - 0.3V) to (V _{CC} + 0.3V)
MAX9118/MAX9120	(V _{EE} - 0.3V) to +6V
Current Into Input Pins.....	±20mA
Output Current.....	±50mA
Output Short-Circuit Duration	10s

Continuous Power Dissipation (T _A = +70°C)	
5-Pin SC70 (derate 2.5mW/°C above +70°C).....	200mW
8-Pin SO (derate 5.88mW/°C above +70°C).....	471mW
Operating Temperature Range	-40°C to +85°C
Junction Temperature	+150°C
Storage Temperature Range	-65°C to +150°C
Lead Temperature (soldering, 10s).....	+300°C

Stresses beyond those listed under "Absolute Maximum Ratings" may cause permanent damage to the device. These are stress ratings only, and functional operation of the device at these or any other conditions beyond those indicated in the operational sections of the specifications is not implied. Exposure to absolute maximum rating conditions for extended periods may affect device reliability.

ELECTRICAL CHARACTERISTICS—MAX9117/MAX9118 (with REF)

(V_{CC} = +5V, V_{EE} = 0V, V_{IN+} = V_{REF}, T_A = -40°C to +85°C, unless otherwise noted. Typical values are at T_A = +25°C.) (Note 1)

PARAMETER	SYMBOL	CONDITIONS		MIN	TYP	MAX	UNITS	
Supply Voltage Range	V _{CC}	Inferred from the PSRR test	T _A = +25°C	1.6		5.5	V	
			T _A = T _{MIN} to T _{MAX}	1.8		5.5		
Supply Current	I _{CC}	V _{CC} = 1.6V	T _A = +25°C		0.60	1	µA	
			T _A = +25°C		0.68	1.3		
			T _A = T _{MIN} to T _{MAX}			1.6		
Supply Current	I _{CC}	V _{CC} = 5V	T _A = +25°C				µA	
			T _A = T _{MIN} to T _{MAX}					
IN+ Voltage Range	V _{IN+}	Inferred from output swing test		V _{EE} - 0.2		V _{CC} + 0.2	V	
Input Offset Voltage	V _{OS}	(Note 2)	T _A = +25°C		1	5	mV	
			T _A = T _{MIN} to T _{MAX}			10		
Input-Referred Hysteresis	V _{HB}	(Note 3)			4		mV	
Input Bias Current	I _B	T _A = +25°C			0.15	1	nA	
		T _A = T _{MIN} to T _{MAX}				2		
Power-Supply Rejection Ratio	PSRR	V _{CC} = 1.6V to 5.5V, T _A = +25°C			0.1	1	mV/V	
		V _{CC} = 1.8V to 5.5V, T _A = T _{MIN} to T _{MAX}				1		
Output Voltage Swing High	V _{CC} - V _{OH}	MAX9117, V _{CC} = 5V, I _{SOURCE} = 5mA	T _A = +25°C		190	400	mV	
			T _A = T _{MIN} to T _{MAX}			500		
		MAX9117, I _{SOURCE} = 1mA	V _{CC} = 1.6V, T _A = +25°C			100		200
			T _A = T _{MIN} to T _{MAX}					300
Output Voltage Swing Low	V _{OL}	V _{CC} = 5V, I _{SINK} = 5mA	T _A = +25°C		190	400	mV	
			T _A = T _{MIN} to T _{MAX}			500		
		I _{SINK} = 1mA	V _{CC} = 1.6V, T _A = +25°C			100		200
			T _A = T _{MIN} to T _{MAX}					300
Output Leakage Current	I _{LEAK}	MAX9118 only, V _O = 5.5V			0.002	1	µA	
Output Short-Circuit Current	I _{SC}	Sourcing, V _O = V _{EE}	V _{CC} = 5V		35		mA	
			V _{CC} = 1.6V		3			
		Sinking, V _O = V _{CC}	V _{CC} = 5V		35			
			V _{CC} = 1.6V		3			
High-to-Low Propagation Delay (Note 4)	t _{PD-}	V _{CC} = 1.6V			16		µs	
		V _{CC} = 5V			14			

SC70, 1.6V, Nanopower, Beyond-the-Rails Comparators With/Without Reference

MAX9117-MAX9120

ELECTRICAL CHARACTERISTICS—MAX9117/MAX9118 (with REF) (continued)

(V_{CC} = +5V, V_{EE} = 0V, V_{IN+} = V_{REF}, T_A = -40°C to +85°C, unless otherwise noted. Typical values are at T_A = +25°C.) (Note 1)

PARAMETER	SYMBOL	CONDITIONS	MIN	TYP	MAX	UNITS
Low-to-High Propagation Delay (Note 4)	t _{PD+}	MAX9117 only	V _{CC} = 1.6V	15		μs
			V _{CC} = 5V	40		
		MAX9118 only	V _{CC} = 1.6V, R _{PULLUP} = 100kΩ	16		
			V _{CC} = 5V, R _{PULLUP} = 100kΩ	45		
Rise Time	t _{RISE}	MAX9117 only, C _L = 15pF	1.6		μs	
Fall Time	t _{FALL}	C _L = 15pF	0.2		μs	
Power-Up Time	t _{ON}		1.2		ms	
Reference Voltage	V _{REF}	T _A = +25°C	1.230	1.252	1.274	V
		T _A = T _{MIN} to T _{MAX}	1.196		1.308	
Reference Voltage Temperature Coefficient	T _{CREF}		100		ppm/°C	
Reference Output Voltage Noise	E _N	BW = 10Hz to 100kHz	1.1		mV _{RMS}	
		BW = 10Hz to 100kHz, C _{REF} = 1nF	0.2			
Reference Line Regulation	$\frac{\Delta V_{REF}}{\Delta V_{CC}}$	V _{CC} = 1.6V to 5.5V	0.25		mV/V	
Reference Load Regulation	$\frac{\Delta V_{REF}}{\Delta I_{OUT}}$	ΔI _{OUT} = 10nA	±1		mV/nA	

ELECTRICAL CHARACTERISTICS—MAX9119/MAX9120 (without REF)

(V_{CC} = +5V, V_{EE} = 0V, V_{CM} = 0V, T_A = -40°C to +85°C, unless otherwise noted. Typical values are at T_A = +25°C.) (Note 1)

PARAMETER	SYMBOL	CONDITIONS	MIN	TYP	MAX	UNITS	
Supply Voltage Range	V _{CC}	Inferred from the PSRR test	T _A = +25°C	1.6	5.5	V	
			T _A = T _{MIN} to T _{MAX}	1.8	5.5		
Supply Current	I _{CC}	V _{CC} = 1.6V, T _A = +25°C		0.35	0.80	μA	
			V _{CC} = 5V	T _A = +25°C	0.45		0.80
				T _A = T _{MIN} to T _{MAX}			1.2
Input Common-Mode Voltage Range	V _{CM}	Inferred from the CMRR test	V _{EE} - 0.2		V _{CC} + 0.2	V	
Input Offset Voltage	V _{OS}	-0.2V ≤ V _{CM} ≤ (V _{CC} + 0.2V) (Note 2)	T _A = +25°C	1	5	mV	
			T _A = T _{MIN} to T _{MAX}		10		
Input-Referred Hysteresis	V _{HB}	-0.2V ≤ V _{CM} ≤ (V _{CC} + 0.2V) (Note 3)	4		mV		
Input Bias Current	I _B		T _A = +25°C	0.15	1	nA	
			T _A = T _{MIN} to T _{MAX}		2		
Input Offset Current	I _{OS}		75		pA		
Power-Supply Rejection Ratio	PSRR	V _{CC} = 1.6V to 5.5V, T _A = +25°C	0.1		1	mV/V	
		V _{CC} = 1.8V to 5.5V, T _A = T _{MIN} to T _{MAX}			1		
Common-Mode Rejection Ratio	CMRR	(V _{EE} - 0.2V) ≤ V _{CM} ≤ (V _{CC} + 0.2V)	0.5		3	mV/V	

SC70, 1.6V, Nanopower, Beyond-the-Rails Comparators With/Without Reference

ELECTRICAL CHARACTERISTICS—MAX9119/MAX9120 (without REF) (continued)

($V_{CC} = +5V$, $V_{EE} = 0V$, $V_{CM} = 0V$, $T_A = -40^{\circ}C$ to $+85^{\circ}C$, unless otherwise noted. Typical values are at $T_A = +25^{\circ}C$.) (Note 1)

PARAMETER	SYMBOL	CONDITIONS		MIN	TYP	MAX	UNITS
Output Voltage Swing High	$V_{CC} - V_{OH}$	MAX9119 only, $V_{CC} = 5V$, $I_{SOURCE} = 5mA$	$T_A = +25^{\circ}C$	190	400	500	mV
			$T_A = T_{MIN}$ to T_{MAX}				
		MAX9119 only, $I_{SOURCE} = 1mA$	$V_{CC} = 1.6V$, $T_A = +25^{\circ}C$	100	200	300	
			$V_{CC} = 1.8V$, $T_A = T_{MIN}$ to T_{MAX}				
Output Voltage Swing Low	V_{OL}	$V_{CC} = 5V$, $I_{SINK} = 5mA$	$T_A = +25^{\circ}C$	190	400	500	mV
			$T_A = T_{MIN}$ to T_{MAX}				
		$I_{SINK} = 1mA$	$V_{CC} = 1.6V$, $T_A = +25^{\circ}C$	100	200	300	
			$V_{CC} = 1.8V$, $T_A = T_{MIN}$ to T_{MAX}				
Output Leakage Current	I_{LEAK}	MAX9120 only, $V_O = 5.5V$		0.001	1		μA
Output Short-Circuit Current	I_{SC}	Sourcing, $V_O = V_{EE}$	$V_{CC} = 5V$	35	3	mA	
			$V_{CC} = 1.6V$				
		Sourcing, $V_O = V_{CC}$	$V_{CC} = 5V$	35	3		
			$V_{CC} = 1.6V$				
High-to-Low Propagation Delay (Note 4)	t_{PD-}		$V_{CC} = 1.6V$	16	14	μs	
			$V_{CC} = 5V$				
Low-to-High Propagation Delay (Note 4)	t_{PD+}	MAX9119 only	$V_{CC} = 1.6V$	15	40	μs	
			$V_{CC} = 5V$				
		MAX9120 only	$V_{CC} = 1.6V$, $R_{PULLUP} = 100k\Omega$	16	45		
			$V_{CC} = 5V$, $R_{PULLUP} = 100k\Omega$				
Rise Time	t_{RISE}	MAX9119 only, $C_L = 15pF$		1.6		μs	
Fall Time	t_{FALL}	$C_L = 15pF$		0.2		μs	
Power-Up Time	t_{ON}			1.2		ms	

Note 1: All specifications are 100% tested at $T_A = +25^{\circ}C$. Specification limits over temperature ($T_A = T_{MIN}$ to T_{MAX}) are guaranteed by design, not production tested.

Note 2: V_{OS} is defined as the center of the hysteresis band at the input.

Note 3: The hysteresis-related trip points are defined as the edges of the hysteresis band, measured with respect to the center of the band (i.e., V_{OS}) (Figure 2).

Note 4: Specified with an input overdrive ($V_{OVERDRIVE}$) of 100mV, and load capacitance of $C_L = 15pF$. $V_{OVERDRIVE}$ is defined above and beyond the offset voltage and hysteresis of the comparator input. For the MAX9117/MAX9118, reference voltage error should also be added.

SC70, 1.6V, Nanopower, Beyond-the-Rails Comparators With/Without Reference

Typical Operating Characteristics

($V_{CC} = +5V$, $V_{EE} = 0V$, $C_L = 15pF$, $V_{OVERDRIVE} = 100mV$, $T_A = +25^\circ C$, unless otherwise noted.)

MAX9117-MAX9120

MAX9117/MAX9118 SUPPLY CURRENT vs. SUPPLY VOLTAGE AND TEMPERATURE

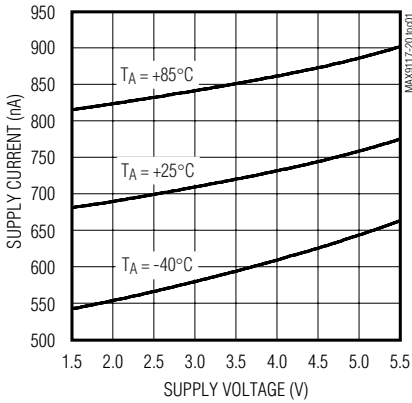

MAX9119/MAX9120 SUPPLY CURRENT vs. SUPPLY VOLTAGE AND TEMPERATURE

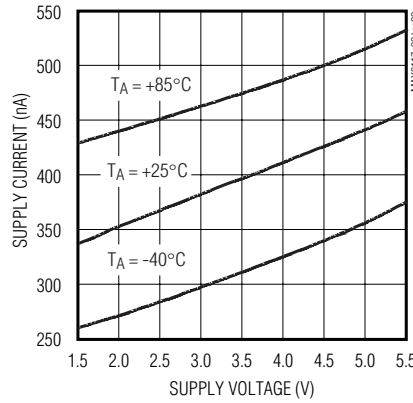

MAX9117/MAX9118 SUPPLY CURRENT vs. TEMPERATURE

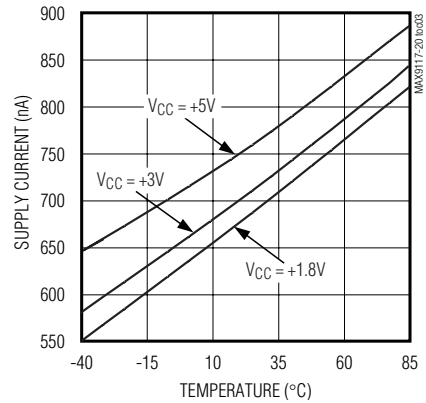

MAX9119/MAX9120 SUPPLY CURRENT vs. TEMPERATURE

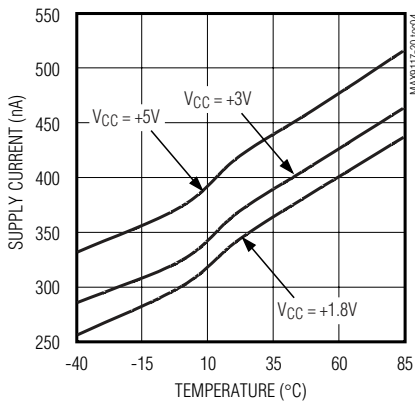

MAX9117/MAX9118 SUPPLY CURRENT vs. OUTPUT TRANSITION FREQUENCY

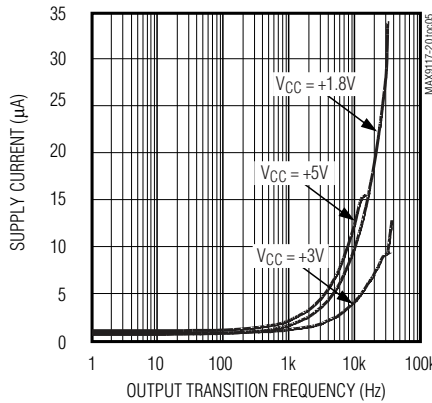

MAX9119/MAX9120 SUPPLY CURRENT vs. OUTPUT TRANSITION FREQUENCY

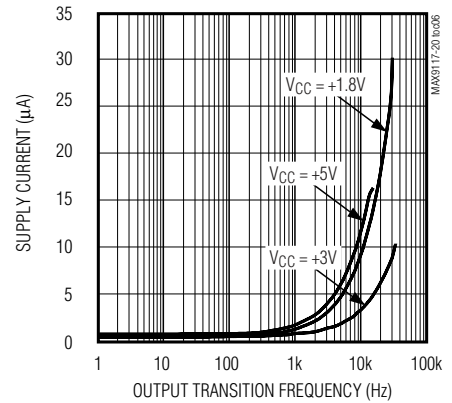

OUTPUT VOLTAGE LOW vs. SINK CURRENT

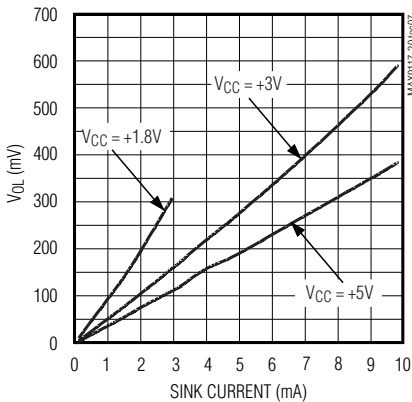

OUTPUT VOLTAGE LOW vs. SINK CURRENT AND TEMPERATURE

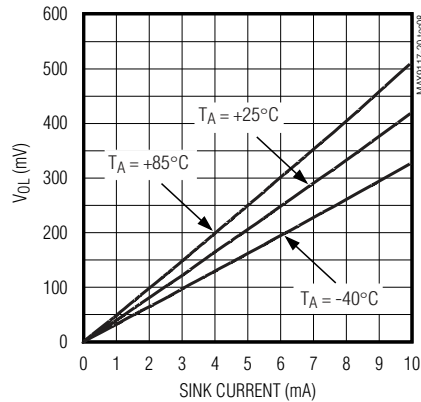

MAX9117/MAX9119 OUTPUT VOLTAGE HIGH vs. SOURCE CURRENT

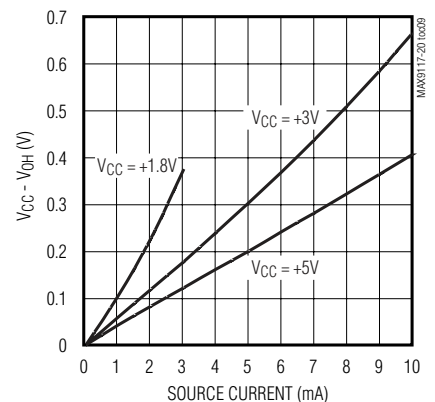

SC70, 1.6V, Nanopower, Beyond-the-Rails Comparators With/Without Reference

Typical Operating Characteristics (continued)

($V_{CC} = +5V$, $V_{EE} = 0V$, $C_L = 15pF$, $V_{OVERDRIVE} = 100mV$, $T_A = +25^\circ C$, unless otherwise noted.)

MAX9117/MAX9119 OUTPUT VOLTAGE HIGH vs. SOURCE CURRENT AND TEMPERATURE

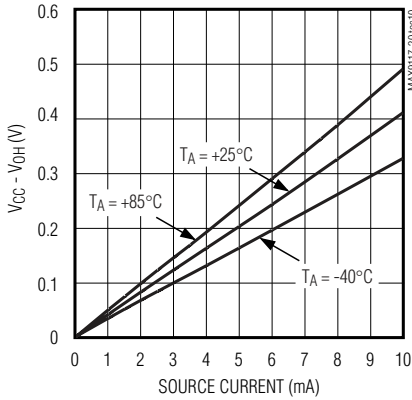

SHORT-CIRCUIT SINK CURRENT vs. TEMPERATURE

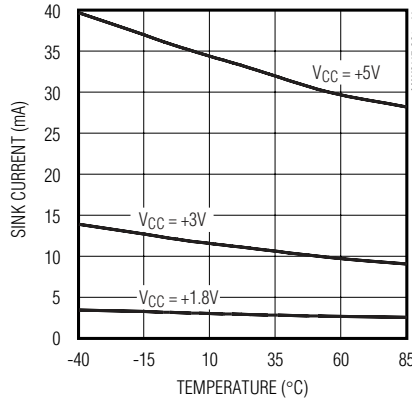

MAX9117/MAX9119 SHORT-CIRCUIT SOURCE CURRENT vs. TEMPERATURE

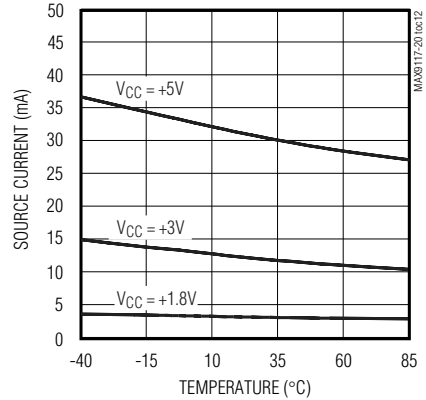

OFFSET VOLTAGE vs. TEMPERATURE

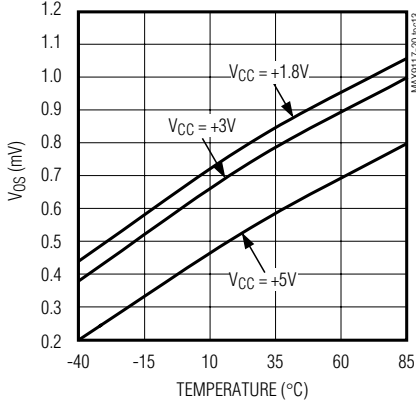

HYSTERESIS VOLTAGE vs. TEMPERATURE

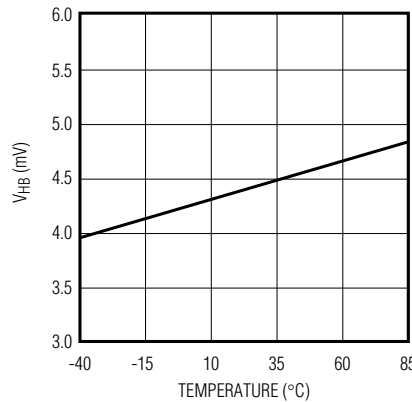

MAX9117/MAX9118 REFERENCE VOLTAGE vs. TEMPERATURE

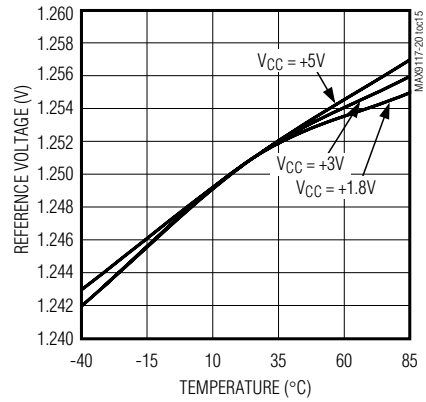

MAX9117/MAX9118 REFERENCE VOLTAGE vs. SUPPLY VOLTAGE

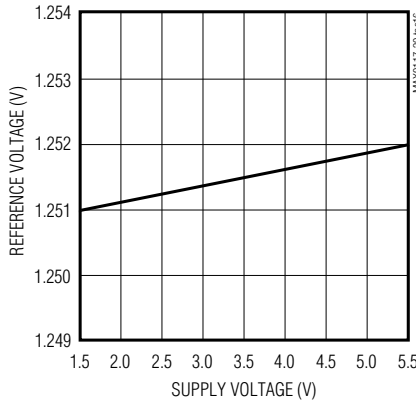

MAX9117/MAX9118 REFERENCE OUTPUT VOLTAGE vs. REFERENCE SOURCE CURRENT

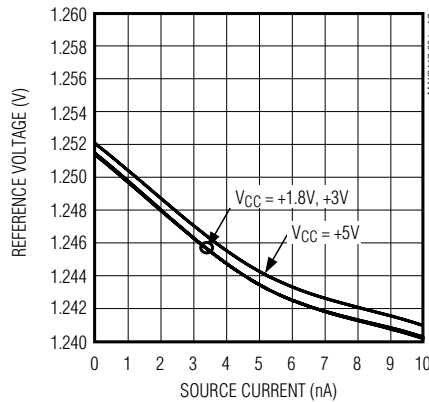

MAX9117/MAX9118 REFERENCE OUTPUT VOLTAGE vs. REFERENCE SINK CURRENT

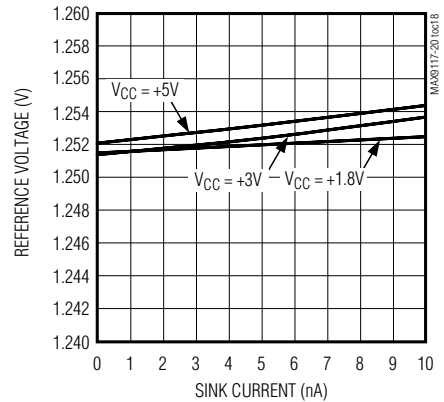

SC70, 1.6V, Nanopower, Beyond-the-Rails Comparators With/Without Reference

Typical Operating Characteristics (continued)

($V_{CC} = +5V$, $V_{EE} = 0V$, $C_L = 15pF$, $V_{OVERDRIVE} = 100mV$, $T_A = +25^\circ C$, unless otherwise noted.)

MAX9117-MAX9120

PROPAGATION DELAY (t_{PD-}) vs. TEMPERATURE

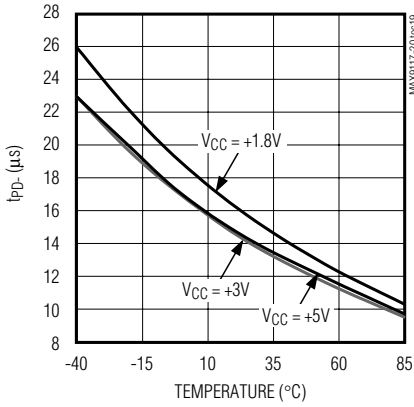

MAX9117/MAX9119 PROPAGATION DELAY (t_{PD+}) vs. TEMPERATURE

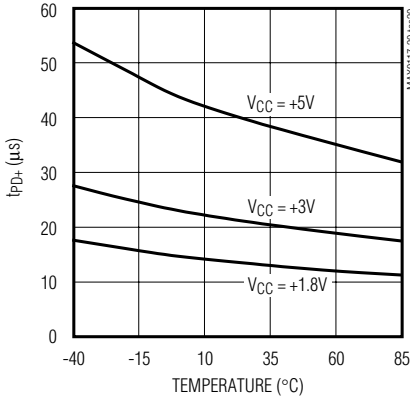

PROPAGATION DELAY (t_{PD-}) vs. CAPACITIVE LOAD

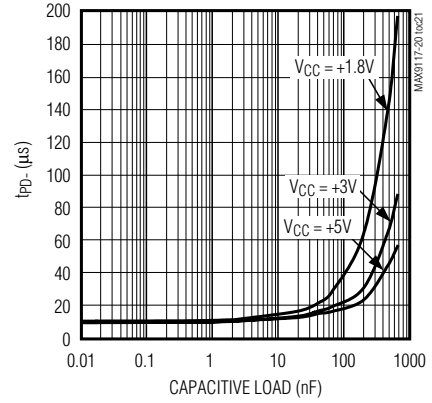

MAX9117/MAX9119 PROPAGATION DELAY (t_{PD+}) vs. CAPACITIVE LOAD

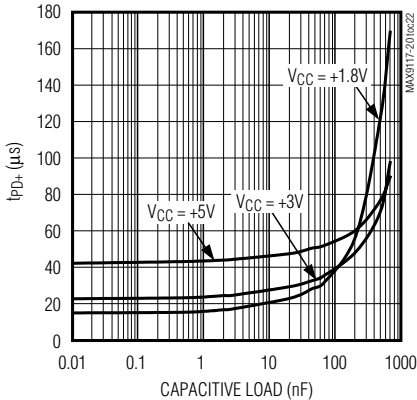

PROPAGATION DELAY (t_{PD-}) vs. INPUT OVERDRIVE

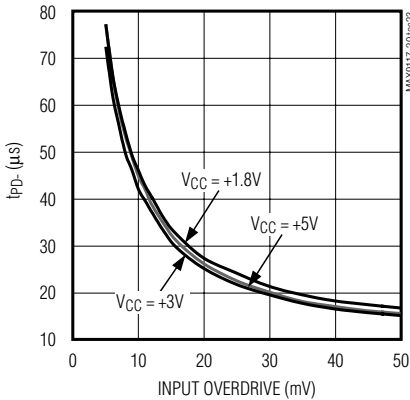

MAX9117/MAX9119 PROPAGATION DELAY (t_{PD+}) vs. INPUT OVERDRIVE

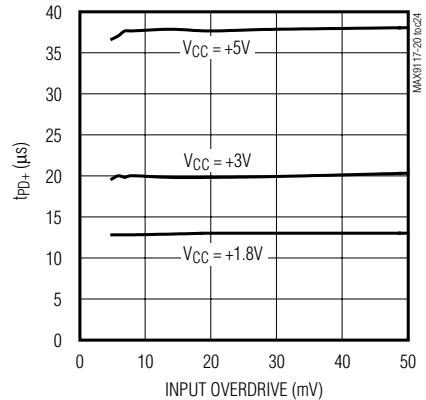

MAX9118/MAX9120 PROPAGATION DELAY (t_{PD-}) vs. PULLUP RESISTANCE

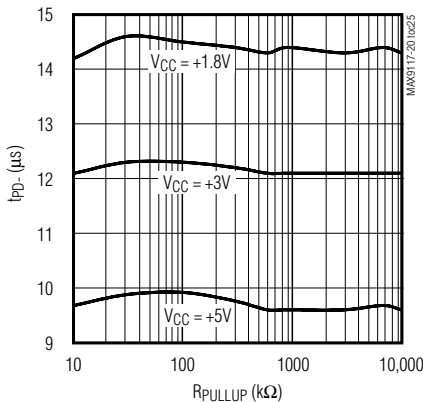

MAX9118/MAX9120 PROPAGATION DELAY (t_{PD+}) vs. PULLUP RESISTANCE

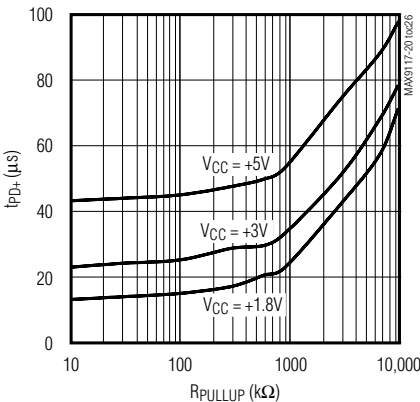

PROPAGATION DELAY (t_{PD-}) ($V_{CC} = +5V$)

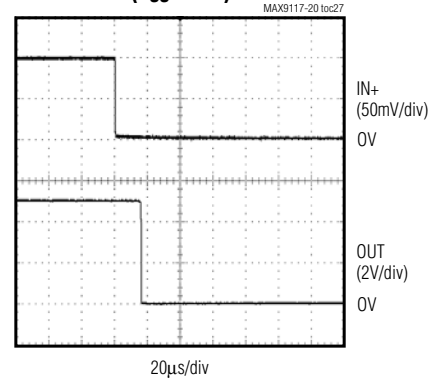

SC70, 1.6V, Nanopower, Beyond-the-Rails Comparators With/Without Reference

Typical Operating Characteristics (continued)

($V_{CC} = +5V$, $V_{EE} = 0V$, $C_L = 15pF$, $V_{OVERDRIVE} = 100mV$, $T_A = +25^\circ C$, unless otherwise noted.)

MAX9117/MAX9119
PROPAGATION DELAY (t_{PD+})
($V_{CC} = +5V$)

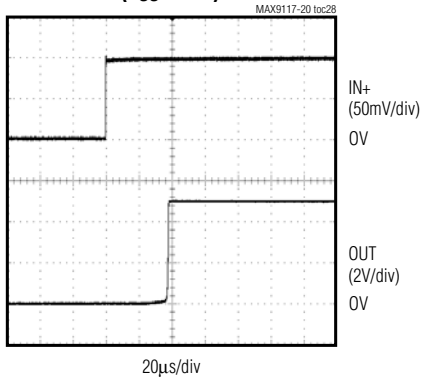

PROPAGATION DELAY (t_{PD-})
($V_{CC} = +3V$)

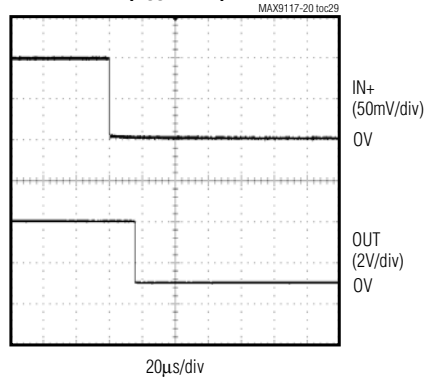

MAX9117/MAX9119
PROPAGATION DELAY (t_{PD+})
($V_{CC} = +3V$)

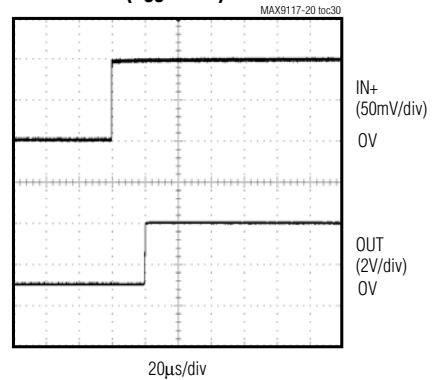

PROPAGATION DELAY (t_{PD-})
($V_{CC} = +1.8V$)

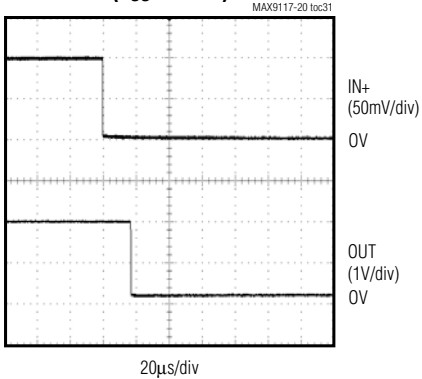

MAX9117/MAX9119
PROPAGATION DELAY (t_{PD+})
($V_{CC} = +1.8V$)

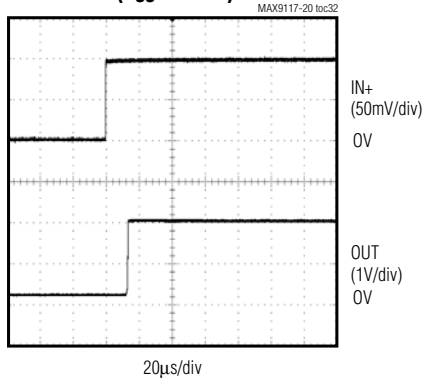

MAX9117/MAX9119
10kHz RESPONSE ($V_{CC} = +1.8V$)

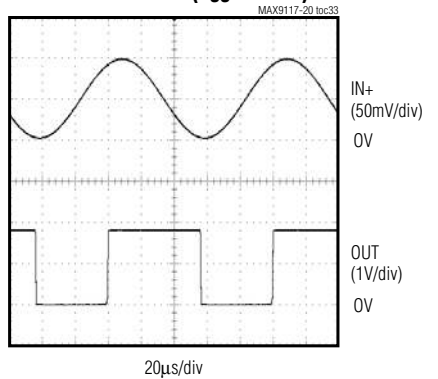

MAX9117/MAX9119
1kHz RESPONSE ($V_{CC} = +5V$)

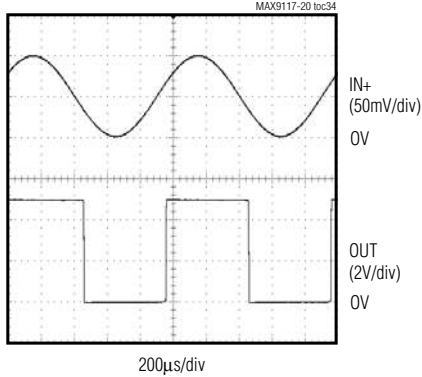

POWER-UP/DOWN RESPONSE

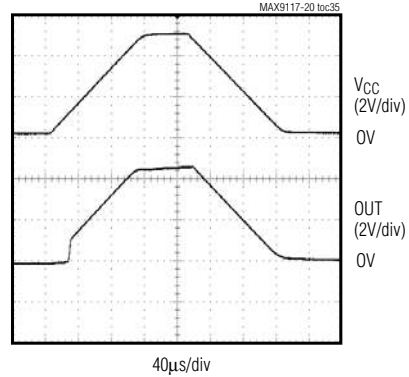

SC70, 1.6V, Nanopower, Beyond-the-Rails Comparators With/Without Reference

Functional Diagrams

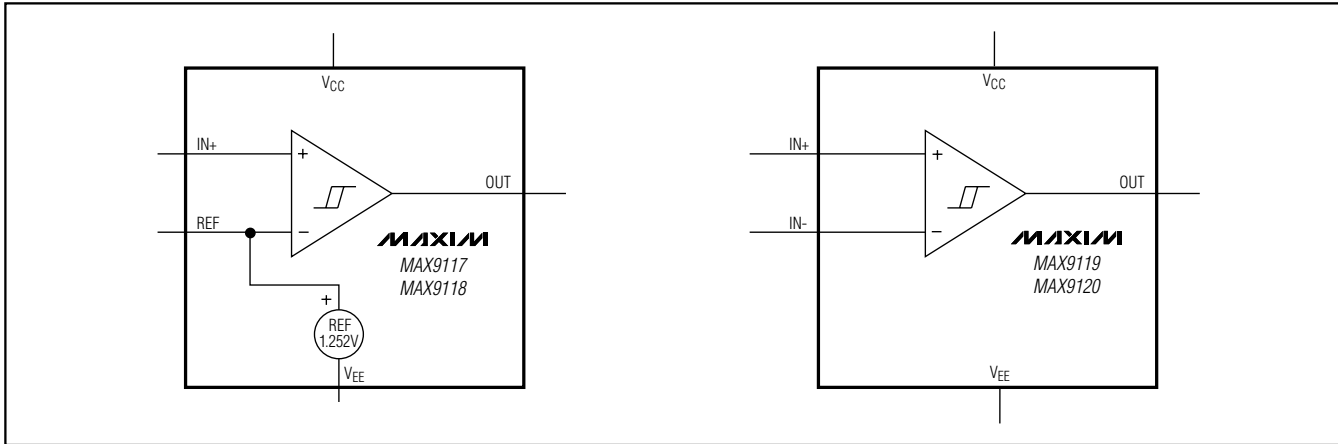

MAX9117-MAX9120

Pin Description

PIN				NAME	FUNCTION
MAX9117/ MAX9118		MAX9119/ MAX9120			
SC70	SO	SC70	SO		
1	6	1	6	OUT	Comparator Output
2	4	2	4	VEE	Negative Supply
3	3	3	3	IN+	Comparator Noninverting Input
4	2	—	—	REF	1.252V Reference
5	7	5	7	VCC	Positive Supply
—	—	4	2	IN-	Comparator Inverting Input
—	1, 5, 8	—	1, 5, 8	N.C.	No Connection. Not internally connected.

Detailed Description

The MAX9117/MAX9118 feature an on-board 1.252V $\pm 1.75\%$ reference, yet draw an ultra-low supply current of 600nA. The MAX9119/MAX9120 (without reference) consume just 350nA of supply current. All four devices are guaranteed to operate down to +1.6V. Their common-mode input voltage range extends 200mV beyond-the-rails. Internal hysteresis ensures clean output switching, even with slow-moving input signals. Large internal output drivers allow rail-to-rail output swing with up to $\pm 5\text{mA}$ loads.

The output stage employs a unique design that minimizes supply-current surges while switching, virtually

eliminating the supply glitches typical of many other comparators. The MAX9117/MAX9119 have a push-pull output stage that sinks as well as sources current. The MAX9118/MAX9120 have an open-drain output stage that can be pulled beyond V_{CC} to an absolute maximum of 6V above V_{EE} . These open-drain versions are ideal for implementing wire-OR output logic functions.

Input Stage Circuitry

The input common-mode voltage range extends from $V_{EE} - 0.2\text{V}$ to $V_{CC} + 0.2\text{V}$. These comparators operate at any differential input voltage within these limits. Input bias current is typically $\pm 0.15\text{nA}$ if the input voltage is between the supply rails. Comparator inputs are protected from overvoltage by internal ESD protection diodes connected to the supply rails. As the input voltage exceeds the supply rails, these ESD protection diodes become forward biased and begin to conduct.

Output Stage Circuitry

The MAX9117-MAX9120 contain a unique break-before-make output stage capable of rail-to-rail operation with up to $\pm 5\text{mA}$ loads. Many comparators consume orders of magnitude more current during switching than during steady-state operation. However, with this family of comparators, the supply-current change during an output transition is extremely small. In the *Typical Operating Characteristics*, the Supply Current vs. Output Transition Frequency graphs show the minimal supply-current increase as the output switching frequency approaches 1kHz. This characteristic reduces the need for power-supply filter capacitors to reduce glitches created by comparator switching currents. In battery-powered applications, this characteristic results in a substantial increase in battery life.

SC70, 1.6V, Nanopower, Beyond-the-Rails Comparators With/Without Reference

Reference (MAX9117/MAX9118)

The internal reference in the MAX9117/MAX9118 has an output voltage of +1.252V with respect to V_{EE} . Its typical temperature coefficient is 100ppm/°C over the full -40°C to +85°C temperature range. The reference is a PNP emitter-follower driven by a 120nA current source (Figure 1). The output impedance of the voltage reference is typically 200k Ω , preventing the reference from driving large loads. The reference can be bypassed with a low-leakage capacitor. The reference is stable for any capacitive load. For applications requiring a lower output impedance, buffer the reference with a low-input-leakage op amp, such as the MAX4162.

Applications Information

Low-Voltage, Low-Power Operation

The MAX9117-MAX9120 are ideally suited for use with most battery-powered systems. Table 1 lists a variety of battery types, capacities, and approximate operating times for the MAX9117-MAX9120, assuming nominal conditions.

Internal Hysteresis

Many comparators oscillate in the linear region of operation because of noise or undesired parasitic feedback. This tends to occur when the voltage on one input is equal or very close to the voltage on the other input. The MAX9117-MAX9120 have internal hysteresis to counter parasitic effects and noise.

The hysteresis in a comparator creates two trip points: one for the rising input voltage (V_{THR}) and one for the falling input voltage (V_{THF}) (Figure 2). The difference between the trip points is the hysteresis (V_{HB}). When the comparator's input voltages are equal, the hysteresis effectively causes one comparator input to move quickly past the other, thus taking the input out of the

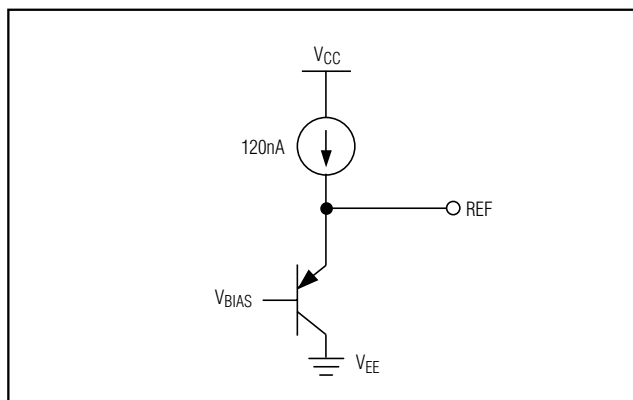

Figure 1. MAX9117/MAX9118 Voltage Reference Output Equivalent Circuit

region where oscillation occurs. Figure 2 illustrates the case in which $IN-$ has a fixed voltage applied, and $IN+$ is varied. If the inputs were reversed, the figure would be the same, except with an inverted output.

Additional Hysteresis (MAX9117/MAX9119)

The MAX9117/MAX9119 have a 4mV internal hysteresis band (V_{HB}). Additional hysteresis can be generated with three resistors using positive feedback (Figure 3). Unfortunately, this method also slows hysteresis response time. Use the following procedure to calculate resistor values.

- 1) Select R_3 . Leakage current at IN is under 2nA, so the current through R_3 should be at least 0.2 μ A to minimize errors caused by leakage current. The current through R_3 at the trip point is $(V_{REF} - V_{OUT}) / R_3$. Considering the two possible output states in solving for R_3 yields two formulas: $R_3 = V_{REF} / I_{R3}$ or $R_3 = (V_{CC} - V_{REF}) / I_{R3}$. Use the smaller of the two resulting resistor values. For example, when using the

Table 1. Battery Applications Using MAX9117-MAX9120

BATTERY TYPE	RECHARGEABLE	V_{FRESH} (V)	$V_{END-OF-LIFE}$ (V)	CAPACITY, AA SIZE (mA-h)	MAX9117/MAX9118 OPERATING TIME (hr)	MAX9119/MAX9120 OPERATING TIME (hr)
Alkaline (2 Cells)	No	3.0	1.8	2000	2.5×10^6	5×10^6
Nickel-Cadmium (2 Cells)	Yes	2.4	1.8	750	937,500	1.875×10^6
Lithium-Ion (1 Cell)	Yes	3.5	2.7	1000	1.25×10^6	2.5×10^6
Nickel-Metal-Hydride (2 Cells)	Yes	2.4	1.8	1000	1.25×10^6	2.5×10^6

SC70, 1.6V, Nanopower, Beyond-the-Rails Comparators With/Without Reference

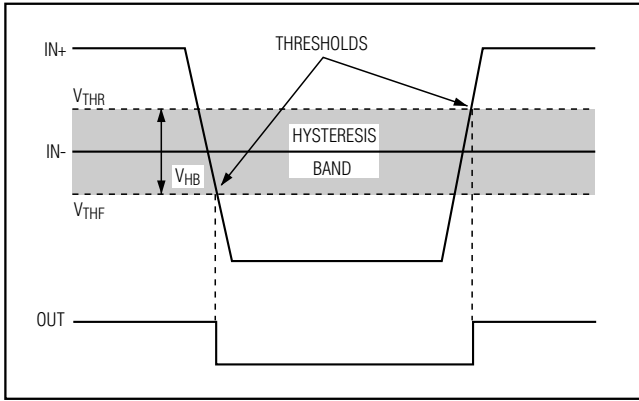

Figure 2. Threshold Hysteresis Band

MAX9117 ($V_{REF} = 1.252V$) and $V_{CC} = +5V$, and if we choose $I_{R3} = 1\mu A$, then the two resistor values are $1.2M\Omega$ and $3.8M\Omega$. Choose a $1.2M\Omega$ standard value for $R3$.

- Choose the hysteresis band required (V_{HB}). For this example, choose $50mV$.
- Calculate $R1$ according to the following equation:

$$R1 = R3 (V_{HB} / V_{CC})$$

For this example, insert the values:

$$R1 = 1.2M\Omega (50mV / 5V) = 12k\Omega$$

- Choose the trip point for V_{IN} rising (V_{THR}) such that $V_{THR} > V_{REF} \times (R1 + R3) / R3$, (V_{THR} is the trip point for V_{IN} rising). This is the threshold voltage at which the comparator switches its output from low to high as V_{IN} rises above the trip point. For this example, choose $3V$.
- Calculate $R2$ as follows:

$$R2 = 1 / [V_{THR} / (V_{REF} \times R1) - (1 / R1) - (1 / R3)]$$

$$R2 = 1 / [3.0V / (1.252V \times 12k\Omega) - (1 / 12k\Omega) - (1 / 1.2M\Omega)] = 8.655k\Omega$$

For this example, choose an $8.66k\Omega$ standard 1% value.

- Verify the trip voltages and hysteresis as follows:

$$V_{IN} \text{ rising: } V_{THR} = V_{REF} \times R1 \left[\left(\frac{1}{R1} \right) + \left(\frac{1}{R2} \right) + \left(\frac{1}{R3} \right) \right] = 3V$$

$$V_{IN} \text{ falling: } V_{THF} = V_{THR} - (R1 \times V_{CC} / R3) = 2.95V$$

$$\text{Hysteresis} = V_{THR} - V_{THF} = 50mV$$

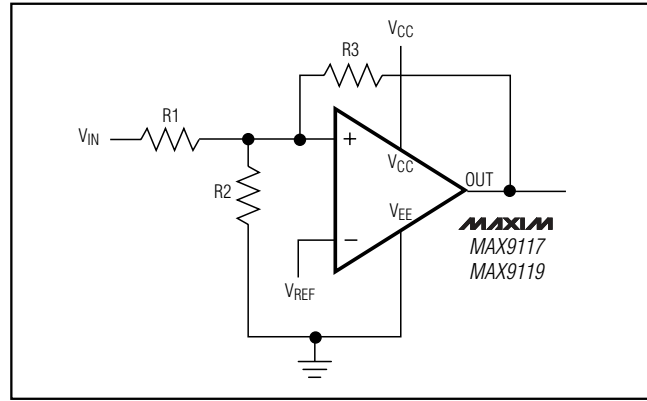

Figure 3. MAX9117/MAX9119 Additional Hysteresis

Additional Hysteresis (MAX9118/MAX9120)

The MAX9118/MAX9120 have a $4mV$ internal hysteresis band. They have open-drain outputs and require an external pullup resistor (Figure 4). Additional hysteresis can be generated using positive feedback, but the formulas differ slightly from those of the MAX9117/MAX9119. Use the following procedure to calculate resistor values.

- Select $R3$ according to the formulas $R3 = V_{REF} / 1\mu A$ or $R3 = (V_{CC} - V_{REF}) / 1\mu A - R4$. Use the smaller of the two resulting resistor values.

- Choose the hysteresis band required (V_{HB}).

- Calculate $R1$ according to the following equation:

$$R1 = (R3 + R4) (V_{HB} / V_{CC})$$

- Choose the trip point for V_{IN} rising (V_{THR}) (V_{THR} is the trip point for V_{IN} rising). This is the threshold voltage at which the comparator switches its output from low to high as V_{IN} rises above the trip point.

- Calculate $R2$ as follows:

$$R2 = 1 / \left[\left(\frac{V_{THR}}{V_{REF} \times R1} \right) - \frac{1}{R1} - \frac{1}{R3} \right]$$

- Verify the trip voltages and hysteresis as follows:

$$V_{IN} \text{ rising: } V_{THR} = V_{REF} \times R1 \left(\frac{1}{R1} + \frac{1}{R2} + \frac{1}{R3} \right)$$

V_{IN} falling:

$$V_{THF} = V_{REF} \times R1 \left(\frac{1}{R1} + \frac{1}{R2} + \frac{1}{R3+R4} \right) - \frac{R1}{R3 + R4} \times V_{CC}$$

$$\text{Hysteresis} = V_{THR} - V_{THF}$$

SC70, 1.6V, Nanopower, Beyond-the-Rails Comparators With/Without Reference

Board Layout and Bypassing

Power-supply bypass capacitors are not typically needed, but use 100nF bypass capacitors close to the device's supply pins when supply impedance is high, supply leads are long, or excessive noise is expected on the supply lines. Minimize signal trace lengths to reduce stray capacitance. A ground plane and surface-mount components are recommended. If the REF pin is decoupled, use a new low-leakage capacitor.

Zero-Crossing Detector

Figure 5 shows a zero-crossing detector application. The MAX9119's inverting input is connected to ground, and its noninverting input is connected to a 100mVp-p signal source. As the signal at the noninverting input crosses 0V, the comparator's output changes state.

Logic-Level Translator

The *Typical Application Circuit* shows an application that converts 5V logic to 3V logic levels. The MAX9120 is powered by the +5V supply voltage, and the pullup resistor for the MAX9120's open-drain output is connected to the +3V supply voltage. This configuration allows the full 5V logic swing without creating overvoltage on the 3V logic inputs. For 3V to 5V logic-level translations, simply connect the +3V supply voltage to VCC and the +5V supply voltage to the pullup resistor.

Typical Application Circuit

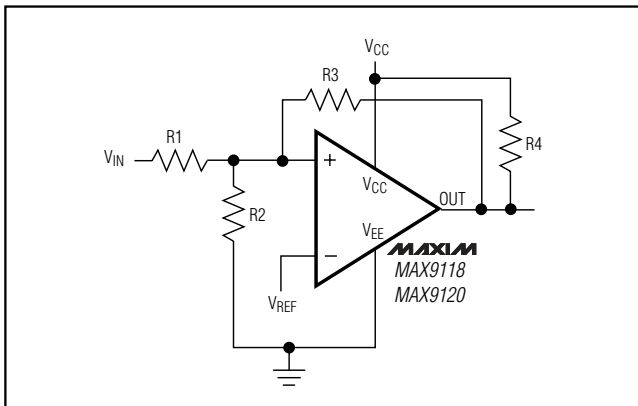
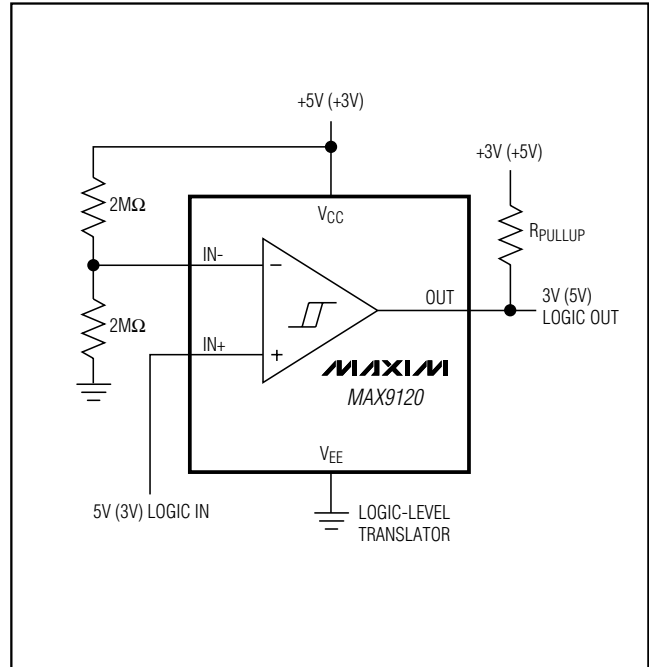

Figure 4. MAX9118/MAX9120 Additional Hysteresis

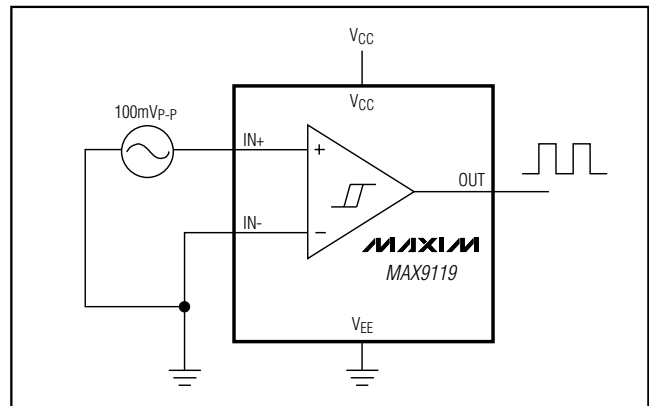

Figure 5. Zero-Crossing Detector

Chip Information

TRANSISTOR COUNT: 98

SC70, 1.6V, Nanopower, Beyond-the-Rails Comparators With/Without Reference

Package Information

(The package drawing(s) in this data sheet may not reflect the most current specifications. For the latest package outline information go to www.maxim-ic.com/packages.)

MAX9117-MAX9120

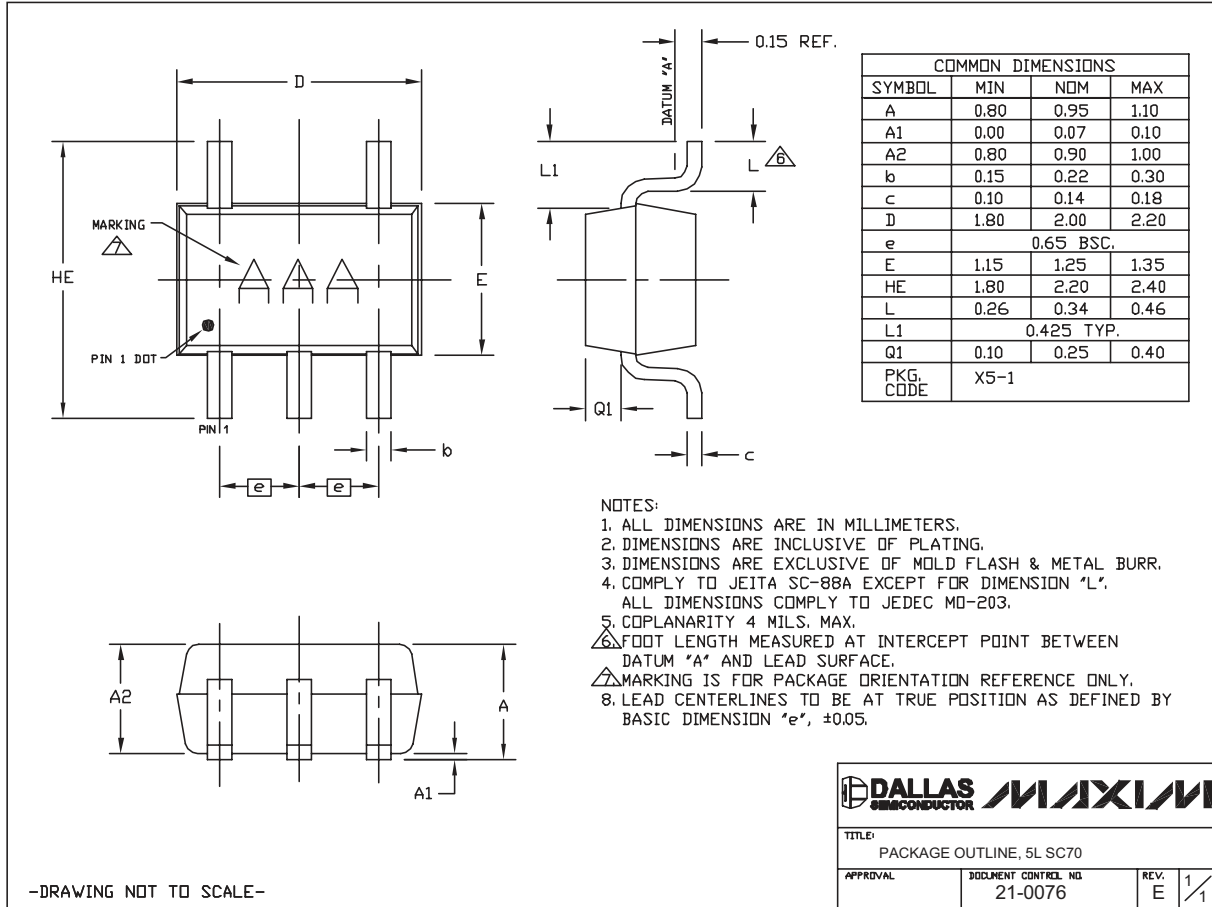

SC70, 5L-EPS

SC70, 1.6V, Nanopower, Beyond-the-Rails Comparators With/Without Reference

Package Information (continued)

(The package drawing(s) in this data sheet may not reflect the most current specifications. For the latest package outline information go to www.maxim-ic.com/packages.)

SOICN EPS

DIM	INCHES		MILLIMETERS	
	MIN	MAX	MIN	MAX
A	0.053	0.069	1.35	1.75
A1	0.004	0.010	0.10	0.25
B	0.014	0.019	0.35	0.49
C	0.007	0.010	0.19	0.25
e	0.050 BSC		1.27 BSC	
E	0.150	0.157	3.80	4.00
H	0.228	0.244	5.80	6.20
L	0.016	0.050	0.40	1.27

VARIATIONS:

DIM	INCHES		MILLIMETERS		N	MS012
	MIN	MAX	MIN	MAX		
D	0.189	0.197	4.80	5.00	8	AA
D	0.337	0.344	8.55	8.75	14	AB
D	0.386	0.394	9.80	10.00	16	AC

NOTES:

1. D&E DO NOT INCLUDE MOLD FLASH.
2. MOLD FLASH OR PROTRUSIONS NOT TO EXCEED 0.15mm (.006").
3. LEADS TO BE COPLANAR WITHIN 0.10mm (.004").
4. CONTROLLING DIMENSION: MILLIMETERS.
5. MEETS JEDEC MS012.
6. N = NUMBER OF PINS.

PROPRIETARY INFORMATION

TITLE:
PACKAGE OUTLINE, .150" SOIC

APPROVAL	DOCUMENT CONTROL NO. 21-0041	REV. B	1/1
----------	---------------------------------	-----------	-----

Revision History

Pages changed at Rev 4: 1, 2, 9, 13

Maxim cannot assume responsibility for use of any circuitry other than circuitry entirely embodied in a Maxim product. No circuit patent licenses are implied. Maxim reserves the right to change the circuitry and specifications without notice at any time.