



Integrated Cellular RF-Section Power-Management IC

MAX8890

General Description

The MAX8890 is a power-management IC intended for cellular handsets using a single lithium-ion (Li+) cell battery with input voltages from +2.5V to +5.5V. The IC contains three identical, low-noise, low-dropout (LDO) linear regulators to provide all of the supply voltage requirements for the RF portion of the handset.

The first LDO is intended to power the transmitter, receiver, and synthesizer. The second LDO is intended to power the TCXO, and high-power voltage-controlled oscillators (VCOs). The third LDO is intended to power the UHF offset VCO.

Each LDO has its own individual enable ($\overline{\text{ON/OFF}}$) control to maximize design flexibility. The reference is powered on if any of the enable inputs (EN1, EN2, EN3) are logic high. The high-accuracy output voltage of each LDO is preset at an internally trimmed voltage (1.8V to 3.3V in 50mV increments). Each LDO is capable of supplying 100mA with a low 50mV dropout and is optimized for low noise and high crosstalk-isolation. Designed with internal P-channel MOSFET pass transistors, the MAX8890's low 180 μ A operating supply current is independent of load.

Other features include short-circuit and thermal-overload protection. The MAX8890 is available in a compact, high-power, 12-pin 4mm x 4mm QFN package with a metal pad on the underside.

Applications

- Cellular Handsets
- Single-Cell Li+ Systems
- 3-Cell NiMH, NiCD, or Alkaline Systems
- Personal Digital Assistants (PDAs)

Standard Preset Output Voltage Suffixes

SUFFIX	OUTPUT VOLTAGE (V)	SUFFIX	OUTPUT VOLTAGE (V)
A	3.30	H	2.75
B	3.00	J	2.70
D	2.90	K	2.50
F	2.85	L	2.00
G	2.80	M	1.80

*Nonstandard output voltages between 1.80V and 3.30V are available in 50mV increments.

Standard Versions table and Pin Configuration appear at end of data sheet.

Features

- ◆ Three 100mA Low-Dropout Linear Regulators
- ◆ Low 50mV Dropout Voltage at 100mA
- ◆ $\pm 1\%$ Output Voltage Accuracy Over Temperature
- ◆ Preset 1.8V to 3.3V Output Voltages (in 50mV Increments)
- ◆ Low 45 μ V_{RMS} Output Voltage Noise
- ◆ Low 180 μ A Operating Supply Current
- ◆ 2.5V to 5.5V Input Voltage Range
- ◆ 67dB PSRR
- ◆ 10 μ V_{P-P} Channel-to-Channel Crosstalk
- ◆ Short-Circuit Protection
- ◆ Thermal-Overload Protection
- ◆ 0.01 μ A Shutdown Current
- ◆ Tiny 12-Pin 4mm x 4mm QFN Package

Ordering Information

PART	TEMP RANGE	PIN PACKAGE
MAX8890ETCxyz*	-40°C to +85°C	12 (4mm x 4mm) QFN

*Each preset output voltage of these devices is factory trimmed to one of ten voltages. Replace "xyz" with the letters corresponding to the desired output voltages (see Standard Preset Output Voltage Suffixes table), where the three letter suffix corresponds to the following output voltages: "x" = V_{OUT1} , "y" = V_{OUT2} , and "z" = V_{OUT3} .

Note: There are five standard versions available (see Standard Versions table). Sample stock is generally held on standard versions only. Standard versions have an order increment requirement of 2500 pieces. Nonstandard versions have an order increment requirement of 10,000 pieces. Contact the factory for availability of nonstandard versions.

Typical Operating Circuit

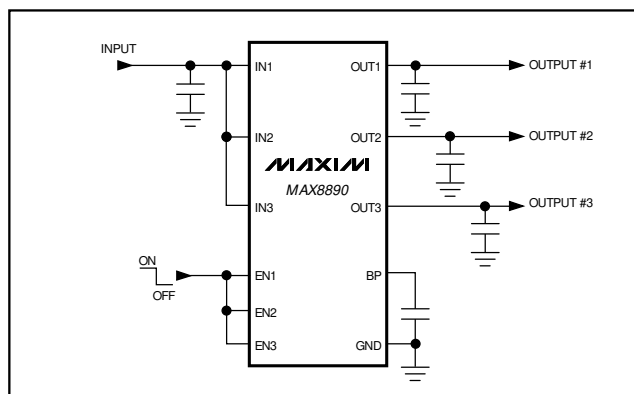

Integrated Cellular RF-Section Power-Management IC

ABSOLUTE MAXIMUM RATINGS

IN_, EN_ to GND.....-0.3V to +6V
 OUT_, BP to GND-0.3V to (VIN_ + 0.3V)
 Output Short-Circuit Protection (Note A)indefinite
 Continuous Power Dissipation (TA = +70°C)
 12-Pin 4 x 4 QFN (derate 16.9mW/°C above +70°C)1349mW

Operating Temperature Range-40°C to +85°C
 Junction Temperature+150°C
 Storage Temperature Range-65°C to +150°C
 Lead Temperature (soldering, 10s)+300°C

Note A: As long as the maximum continuous power dissipation rating is not exceeded, the output can be shorted indefinitely.

Stresses beyond those listed under "Absolute Maximum Ratings" may cause permanent damage to the device. These are stress ratings only, and functional operation of the device at these or any other conditions beyond those indicated in the operational sections of the specifications is not implied. Exposure to absolute maximum rating conditions for extended periods may affect device reliability.

ELECTRICAL CHARACTERISTICS

(VIN_ = 3.6V, EN_ = IN_, CIN = 6.8μF, COU_ = 2.2μF, CBP = 0.01μF, all ceramic capacitors TA = 0°C to +85°C, unless otherwise noted. Typical values are at TA = +25°C.)

PARAMETER	SYMBOL	CONDITIONS	MIN	TYP	MAX	UNITS
GENERAL						
Input Voltage	VIN_		2.5		5.5	V
Input Undervoltage Lockout Threshold	VUVLO	Rising and falling edge	2.10	2.25	2.45	V
Input Undervoltage Hysteresis				45		mV
SUPPLY CURRENT						
Quiescent Supply Current	IQ	IOU_ = 0		180	330	μA
Shutdown Supply Current		EN_ = OUT_ = GND		0.01	10	μA
LINEAR REGULATORS						
Output Voltage Accuracy	VOUT_	VIN_ = 0.5V + the highest of (VOUT1, VOUT2, or VOUT3), IOU_ = 1mA to 100mA	TA = +85°C	-1	+1	%
			TA = 0°C +85°C	-2	+2	
Current Limit	ILIM	OUT_ = GND	120	250	500	mA
Output Pulldown Resistance	ROUT_	EN_ = GND	3	5	8	kΩ
Dropout Voltage (Note 1)	VIN_ - VOUT_	IOU_ = 1mA		1		mV
		IOU_ = 50mA		25		
		IOU_ = 100mA		50	100	
Line Regulation		VIN_ = (VOUT_ + 0.1V) to 5.5V for VOUT_ ≥ 2.4V, or VIN_ = 2.5V to 5.5V for VOUT_ < 2.4V, IOU_ = 1mA	-0.15		+0.15	%/V
Output Voltage Noise		10Hz to 100kHz, COU_ = 10μF ceramic, VOUT_ = 2.8V, IOU_ = 10mA		45		μVRMS
Output Voltage PSRR		100Hz, COU_ = 2.2μF ceramic, IOU_ = 10mA		67		dB
Channel-to-Channel Isolation		10kHz, COU_ = 2.2μF ceramic, IOU_ = 10mA		64		dB

Integrated Cellular RF-Section Power-Management IC

MAX8890

ELECTRICAL CHARACTERISTICS (continued)

($V_{IN_} = 3.6V$, $EN_ = IN_$, $C_{IN} = 6.8\mu F$, $C_{OUT_} = 2.2\mu F$, $C_{BP} = 0.01\mu F$, all ceramic capacitors $T_A = 0^\circ C$ to $+85^\circ C$, unless otherwise noted. Typical values are at $T_A = +25^\circ C$.)

PARAMETER	SYMBOL	CONDITIONS	MIN	TYP	MAX	UNITS
ENABLE LOGIC CONTROL						
EN_ Input Threshold	$V_{EN_}$	$2.5V \leq V_{IN_} \leq 5.5V$	0.4		1.6	V
EN_ Input Bias Current	$I_{EN_}$	$V_{EN_} = 5.5V$ or 0, $T_A = +85^\circ C$	-1		+1	μA
THERMAL PROTECTION						
Thermal-Shutdown Temperature	T_{SHDN}	Rising temperature		160		$^\circ C$
Thermal-Shutdown Hysteresis	ΔT_{SHDN}			15		$^\circ C$

ELECTRICAL CHARACTERISTICS

($V_{IN_} = 3.6V$, $EN_ = IN_$, $C_{IN} = 6.8\mu F$, $C_{OUT_} = 2.2\mu F$, $C_{BP} = 0.01\mu F$, all ceramic capacitors $T_A = -40^\circ C$ to $+85^\circ C$, unless otherwise noted.) (Note 2)

PARAMETER	SYMBOL	CONDITIONS	MIN	MAX	UNITS	
GENERAL						
Input Voltage	$V_{IN_}$		2.5	5.5	V	
Input Undervoltage Lockout Threshold	V_{UVLO}	Rising and falling edge	2.10	2.45	V	
SUPPLY CURRENT						
Quiescent Supply Current	I_Q	$I_{OUT_} = 0$		330	μA	
Shutdown Supply Current		$EN_ = OUT_ = GND$		10	μA	
LINEAR REGULATORS						
Output Voltage Accuracy	$V_{OUT_}$	$V_{IN_} = 0.5V$ + the highest of (V_{OUT1} , V_{OUT2} , or V_{OUT3}), $I_{OUT_} = 1mA$ to $100mA$	-2	+2	%	
Current Limit	I_{LIM}	$OUT_ = GND$	110	500	mA	
Output Pulldown Resistance	$R_{OUT_}$	$EN_ = GND$	3	8	$k\Omega$	
Dropout Voltage	$V_{IN_} - V_{OUT_}$	$I_{OUT_} = 100mA$ (Note 1)		100	mV	
Line Regulation		$V_{IN_} = (V_{OUT_} + 0.1V)$ to $5.5V$ for $V_{OUT_} \geq 2.4V$, or $V_{IN_} = 2.5V$ to $5.5V$ for $V_{OUT_} < 2.4V$, $I_{OUT} = 1mA$	-0.15	+0.15	%/V	
ENABLE LOGIC CONTROL						
EN_ Input Threshold	$V_{EN_}$	$2.5V \leq V_{IN_} \leq 5.5V$	0.4		1.6	V
EN_ Input Bias Current	$I_{EN_}$	$V_{EN_} = 5.5V$ or 0, $T_A = +85^\circ C$	-1		+1	μA

Note 1: The dropout voltage is defined as $V_{IN_} - V_{OUT_}$, when $V_{OUT_}$ is 100mV below the set output voltage (the value of $V_{OUT_}$ for $V_{IN_} = V_{OUT_} + 500mV$). Since the minimum input voltage range is 2.5V, this specification is only meaningful when the set output voltage exceeds 2.7V ($V_{OUT_}(NOM) \geq 2.7V$).

Note 2: Specifications to $-40^\circ C$ are guaranteed by design, not production tested.

Integrated Cellular RF-Section Power-Management IC

Typical Operating Characteristics

(Circuit of Figure 1, MAX8890ETCGGG, $V_{IN} = 3.3V$, $EN_{-} = IN_{-}$, $T_A = +25^{\circ}C$, unless otherwise noted.)

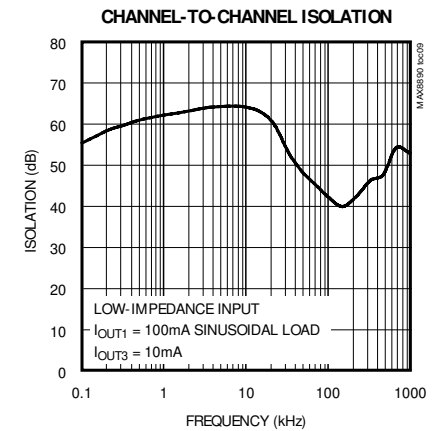
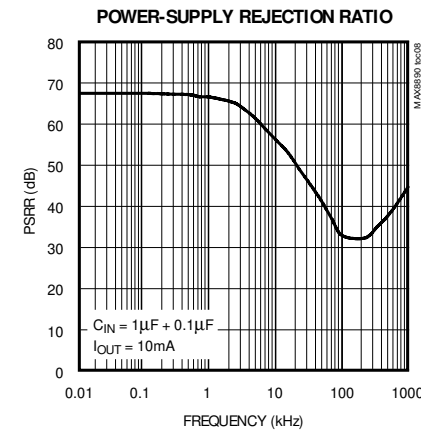
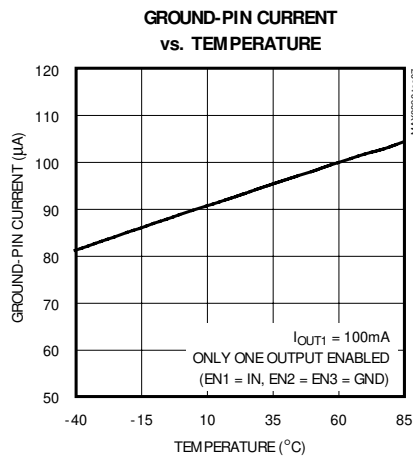
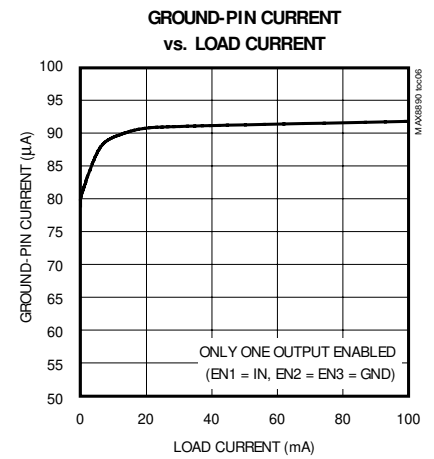
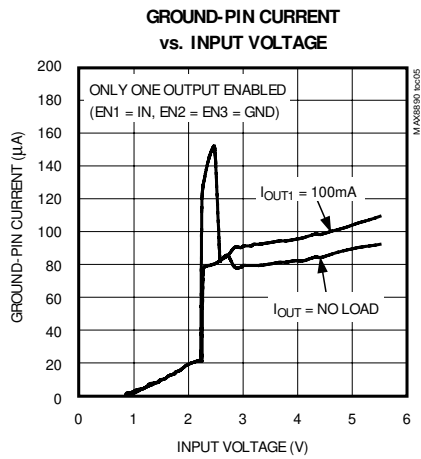
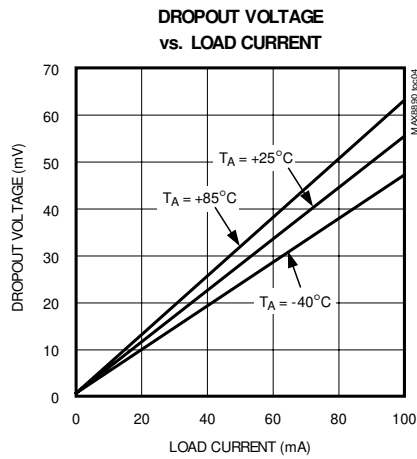
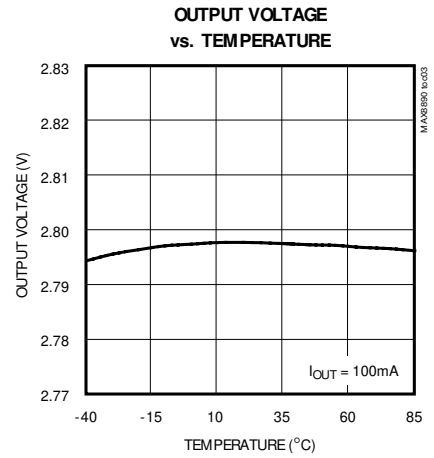
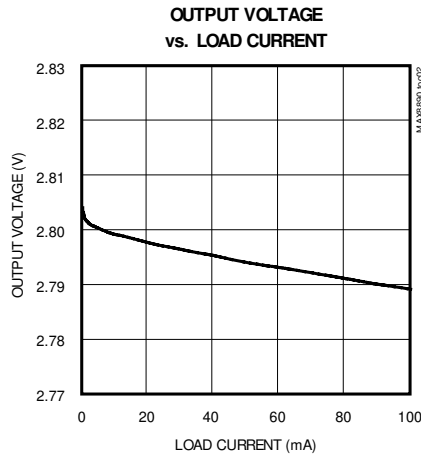
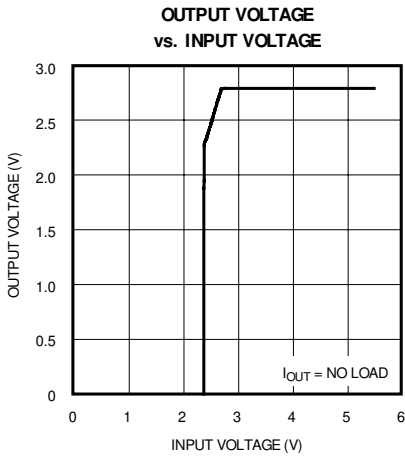

Integrated Cellular RF-Section Power-Management IC

MAX8890

Typical Operating Characteristics (continued)

(Circuit of Figure 1, MAX8890ETCGGG, $V_{IN} = 3.3V$, $EN_{-} = IN_{-}$, $T_A = +25^{\circ}C$, unless otherwise noted.)

LOAD TRANSIENT

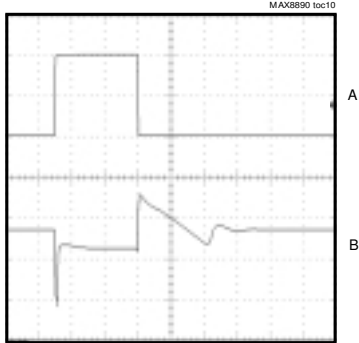

20µs/div

A. $I_{OUT-} = 1mA$ to $100mA$, 50mA/div
 B. $V_{OUT-} = 2.8V$, 20mV/div
 $V_{IN} = 3.3V$ ($V_{OUT-} + 500mV$)

LOAD TRANSIENT NEAR DROPOUT

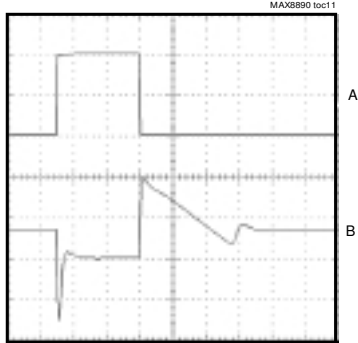

20µs/div

A. $I_{OUT-} = 1mA$ to $100mA$, 50mA/div
 B. $V_{OUT-} = 2.8V$, 20mV/div
 $V_{IN} = 2.9V$ ($V_{OUT-} + 100mV$)

LINE TRANSIENT RESPONSE

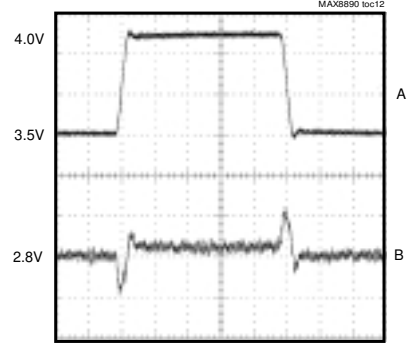

40µs/div

A. $V_{IN} = 3.5V$ to $4.0V$, 200mV/div
 B. $V_{OUT-} = 2.8V$, 2mV/div
 $I_{OUT} = 100mA$

CROSSTALK VOLTAGE

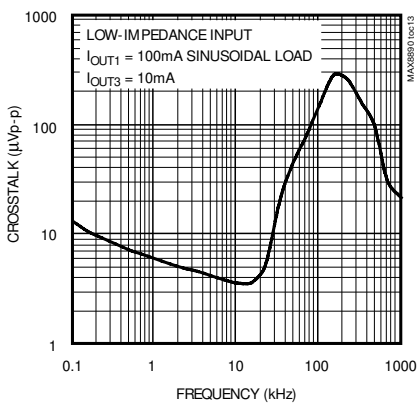

**STARTUP WAVEFORM
($C_{BP} = 0.01\mu F$)**

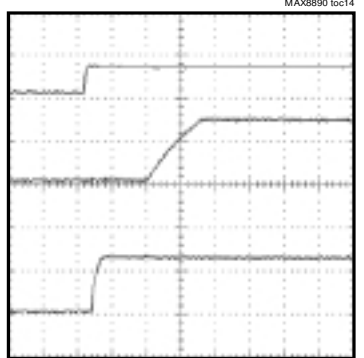

20µs/div

A. $V_{IN} = 0$ to $3.3V$, 5V/div
 B. $V_{OUT-} = 2.8V$, 2V/div
 C. $V_{BP} = 1.25V$, 1V/div
 $R_{OUT-} = 28\Omega$ (100mA)

**STARTUP WAVEFORM
($C_{BP} = 0.1\mu F$)**

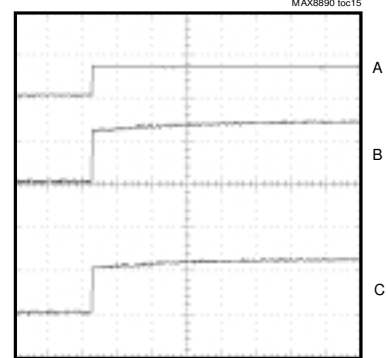

5ms/div

A. $V_{IN} = 0$ to $3.3V$, 5V/div
 B. $V_{OUT-} = 2.8V$, 2V/div
 C. $V_{BP} = 1.25V$, 1V/div
 $R_{OUT-} = 28\Omega$ (100mA)

Integrated Cellular RF-Section Power-Management IC

Typical Operating Characteristics (continued)

(Circuit of Figure 1, MAX8890ETCGGG, $V_{IN} = 3.3V$, $EN_{-} = IN_{-}$, $T_A = +25^{\circ}C$, unless otherwise noted.)

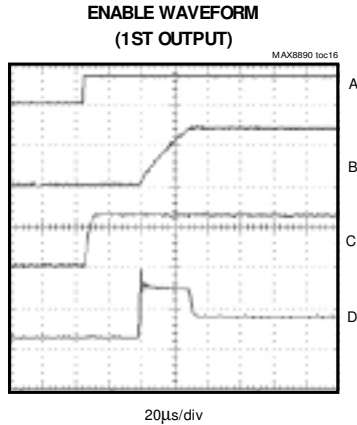

A. $V_{EN1} = 0$ to $3.3V$, 5V/div
 B. $V_{OUT1} = 2.8V$, $R_{OUT1} = 28\Omega$ (100mA), 2V/div
 C. $V_{BP} = 1.25V$, 1V/div
 D. I_{IN} , 200mA/div
 $V_{IN} = 3.3V$, $EN2 = EN3 = GND$, $C_{BP} = 0.01\mu F$

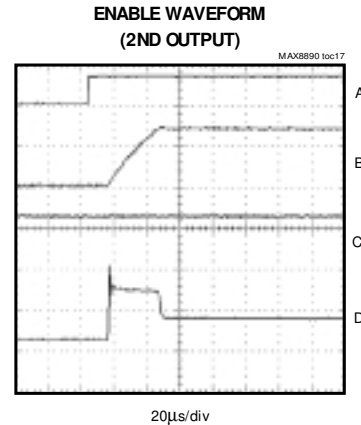

A. $V_{EN2} = 0$ to $3.3V$, 5V/div
 B. $V_{OUT2} = 2.8V$, $R_{OUT2} = 28\Omega$ (100mA), 2V/div
 C. $V_{BP} = 1.25V$, 1V/div
 D. I_{IN} , 200mA/div
 $V_{IN} = 3.3V$, $EN1 = IN$, $EN3 = GND$, $C_{BP} = 0.01\mu F$

Pin Description

PIN	NAME	FUNCTION
1	IN1	Regulator 1 Input. Supply voltage can range from 2.5V to 5.5V. Bypass with a capacitor to GND (see <i>Capacitor Selection and Regulator Stability</i> section).
2	IN2	Regulator 2 Input. Supply voltage can range from 2.5V to V_{IN1} . Bypass with a capacitor to GND (see <i>Capacitor Selection and Regulator Stability</i> section).
3	OUT2	Regulator 2 Output. Sources up to 100mA. Bypass with a 2.2 μ F ceramic capacitor to GND.
4	EN1	Active-High Enable Input for Regulator 1. A logic low shuts down the first linear regulator. In shutdown, OUT1 is pulled low through an internal 5k Ω resistor. Connect to IN1 for normal operation.
5	EN2	Active-High Enable Input for Regulator 2. A logic low shuts down the second linear regulator. In shutdown, OUT2 is pulled low through an internal 5k Ω resistor. Connect to IN2 for normal operation.
6	EN3	Active-High Enable Input for Regulator 3. A logic low shuts down the third linear regulator. In shutdown, OUT3 is pulled low through an internal 5k Ω resistor. Connect to IN3 for normal operation.
7	BP	1.25V Voltage Reference Bypass Pin. Connect a 0.01 μ F ceramic bypass capacitor from BP to GND to minimize the output noise. Make no other connection to this pin.
8	GND	Ground. Connect both ground pins together externally, as close to the IC as possible.
9	IN3	Regulator 3 Input. Supply voltage can range from 2.5V to V_{IN1} . Bypass with a capacitor to GND (see <i>Capacitor Selection and Regulator Stability</i> section).
10	OUT3	Regulator 3 Output. Sources up to 100mA. Bypass with a 2.2 μ F ceramic capacitor to GND.
11	GND	Ground. Connect both ground pins together externally, as close to the IC as possible.
12	OUT1	Regulator 1 Output. Sources up to 100mA. Bypass with a 2.2 μ F ceramic capacitor to GND.
EP	GND	Ground. THE EXPOSED PAD AND ALL FOUR CORNER TABS ON THE QFN PACKAGE ARE INTERNALLY CONNECTED TO GROUND. The exposed pad functions as a heatsink. Solder to a large pad or to the circuit board ground plane to maximize power dissipation. Do not use as device ground.

Integrated Cellular RF-Section Power-Management IC

MAX8890

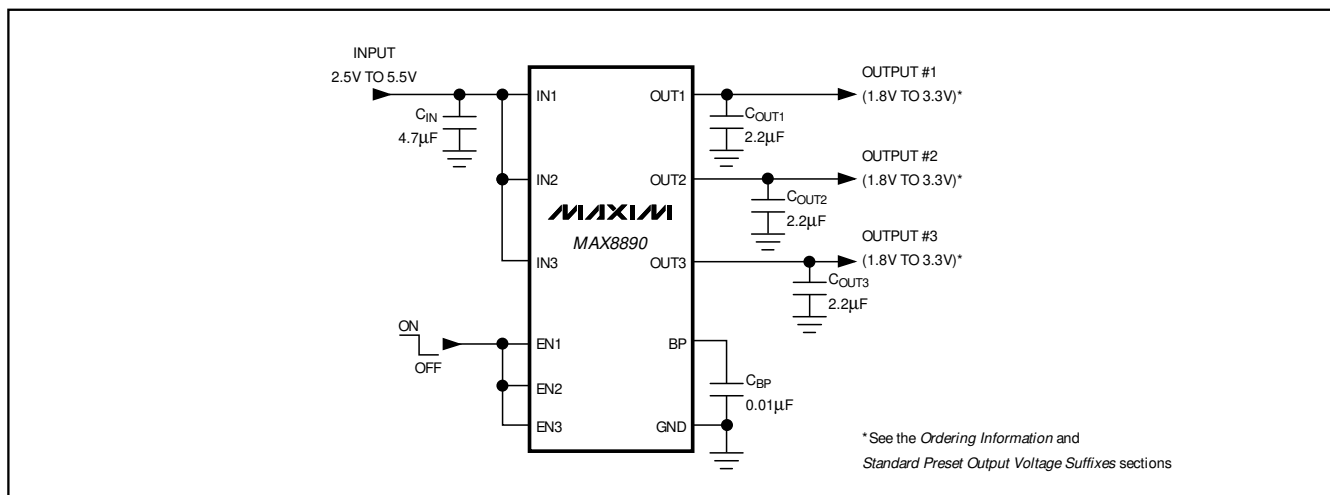

Figure 1. Typical Application Circuit

Detailed Description

The MAX8890 is an RF power-management IC for a cellular phone. The MAX8890 contains three low-noise, low quiescent current, low-dropout, linear regulators for powering the transmitter, receiver, synthesizer, TCXO, and voltage controlled oscillators (VCOs). Each low-dropout linear regulator (LDO) supplies loads up to 100mA and is available with preset output voltages from 1.8V to 3.3V in 50mV increments. Furthermore, the MAX8890's input voltage range of 2.5V to 5.5V is perfect for single-cell Li+ battery or 3-cell NiMH battery applications.

As illustrated in Figure 2, each regulator consists of an error amplifier, internal feedback resistive-divider, and P-channel MOSFET pass transistor. The output voltage feeds back through the internal resistive-divider connected to OUT_. This feedback voltage connects to the error amplifier, which compares the feedback voltage with the internal 1.25V reference voltage and amplifies the difference. If the feedback voltage is lower than the reference voltage, the pass-transistor gate is pulled lower, which allows more current to flow to the output and increases the output voltage. If the feedback voltage is too high, the pass-transistor gate is pulled up, allowing less current to flow to the output.

Clear transmission and reception in a cellular phone can only be achieved with a low-noise power supply. Therefore, all three LDOs on the MAX8890 feature low output voltage noise, high power-supply rejection ratios, and excellent load and line regulation characteristics. Designed for single-cell Li+ battery applications where a pulsed current demand is required from the

battery, each LDO is designed with 45µV_{RMS} noise from 10Hz to 100kHz and PSRR of 67dB.

The MAX8890 also features output current limiting (short-circuit protection), a low-power shutdown mode, and thermal overload protection.

Internal P-Channel Pass MOSFET

Each linear regulator features a 0.5Ω P-channel MOSFET pass transistor. Unlike similar designs using PNP pass transistors, P-channel MOSFETs require no base drive, which reduces the quiescent current. PNP based regulators also waste considerable current in dropout when the pass transistor saturates and use high base-drive currents under large loads. The MAX8890 does not suffer from these problems and consumes only 180µA of quiescent current (all three regulators enabled).

Current Limit (Short-Circuit Protection)

The MAX8890 contains separate current-limit circuitry for each linear regulator. The device monitors and controls the gate voltage of each pass transistor, limiting the regulator's output current to 250mA (typ). The output can be shorted to ground for an indefinite period of time without damage to the part as long as the maximum continuous power dissipation rating is not exceeded.

Output Voltage Selection

The MAX8890 is supplied with factory-set output voltages from 1.8V to 3.3V in 50mV increments. The three-letter part number suffix identifies the output voltage for each regulator. For example, the MAX8890ETCAKM's output voltages are preset to 3.3V (V_{OUT1}), 2.5V (V_{OUT2}), and 1.8V (V_{OUT3}).

Integrated Cellular RF-Section Power-Management IC

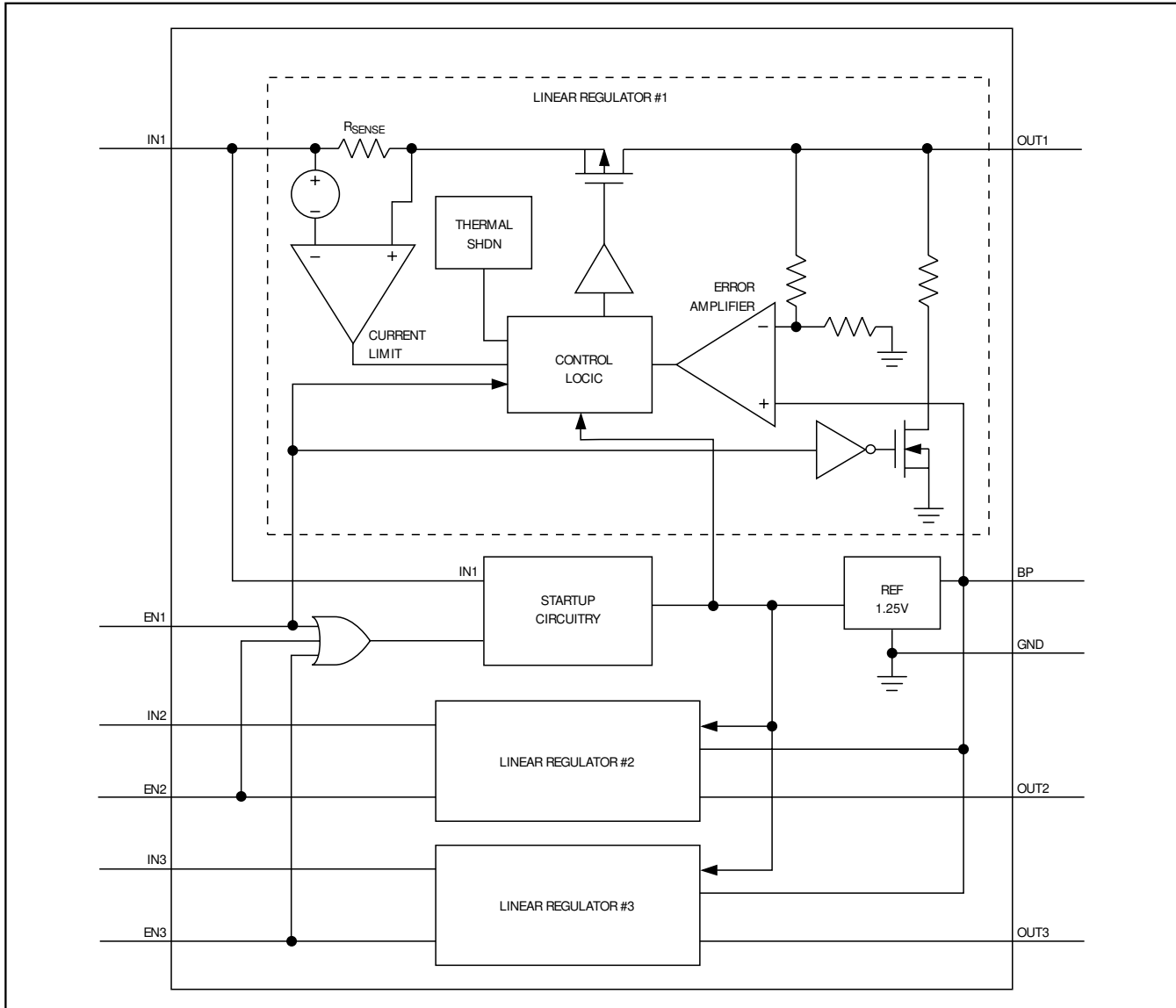

Figure 2. Functional Diagram

Enable

If any one of the three low-dropout linear regulators (LDOs) is enabled, the internal 1.25V reference powers up. Therefore, all three LDOs must be disabled to shut down the internal reference, reducing the supply current to 0.01 μ A.

Pull EN_n low to enter shutdown. When any one of the linear regulators is shutdown, the corresponding MAX8890 output disconnects from the corresponding input, and the output discharges through an internal

5k Ω resistor. The capacitance and load determine the rate at which V_{OUT_n} decays. Do not leave EN_n floating. Connect EN_n to IN_n for normal operation. EN_n can be pulled as high as 6V, regardless of the input and output voltages.

Thermal-Overload Protection

Thermal-overload protection limits the MAX8890's total power dissipation in the event of fault conditions. Each linear regulator has its own thermal-shutdown circuitry.

Integrated Cellular RF-Section Power-Management IC

MAX8890

When the junction temperature exceeds $T_J = 160^\circ\text{C}$, a thermal sensor activates the shutdown logic, disabling the overheated regulator. The thermal sensor turns the linear regulator on again after the regulator's junction temperature cools by 15°C , resulting in a pulsed output during continuous thermal-overload conditions. For continuous operation, do not exceed the absolute maximum junction-temperature rating of $T_J = 150^\circ\text{C}$.

Applications Information

Capacitor Selection and Regulator Stability

Capacitors are required at each input and each output of the MAX8890 for stable operation over the full load range and full temperature range. Connect a minimum $2.2\mu\text{F}$ ceramic capacitor between OUT_- and ground to ensure stability and optimum transient response. Use larger $10\mu\text{F}$ ceramic output capacitors for lower noise requirements.

The input capacitor (C_{IN_-}) lowers the source impedance of the input supply, thereby reducing the input noise and improving transient response. Connect a minimum $1\mu\text{F}$ ceramic capacitance between each IN_- and ground. Place all input and output capacitors as close to the MAX8890 as possible to minimize the impact of PC board trace impedance. Because IN_1 and IN_2 are next to each other, they may easily share a single $2.2\mu\text{F}$ or larger ceramic capacitor.

Surface-mount ceramic capacitors have very low ESR and are commonly available in values up to $10\mu\text{F}$. However, note that some ceramic dielectrics exhibit large capacitance and ESR variation with temperature. Z5U and Y5V dielectrics may require a minimum $3.3\mu\text{F}$ nominal output capacitance, especially with low temperature operation.

Reference Bypass Capacitor

An external bypass capacitor is connected to BP to reduce the inherent reference noise. The capacitor forms a lowpass filter in conjunction with an internal network. Use a $0.01\mu\text{F}$ or greater ceramic capacitor connected as close to BP as possible. Capacitance values greater than $0.01\mu\text{F}$ will increase the startup time. (See *Typical Operating Characteristics* for startup waveforms.) For the lowest noise, increase the bypass capacitor to $0.1\mu\text{F}$. Values above $0.1\mu\text{F}$ provide no performance improvement and are therefore not recommended. Do not place any additional loading on this reference bypass pin.

Noise, PSRR, and Transient Response

The MAX8890 is designed to operate with low dropout voltages and low quiescent currents in battery-powered systems while providing low noise, fast transient response, and high AC rejection. See the *Typical Operating Characteristics* for a plot of Power-Supply Rejection Ratio (PSRR) vs. Frequency. When operating from noisy sources, improved supply-noise rejection and transient response can be achieved by increasing the values of the input and output bypass capacitors and through passive filtering techniques.

The MAX8890 load-transient response graphs (see *Typical Operating Characteristics*) show two components of the output response: a DC shift from the output impedance due to the load current change and the transient response. Increasing the output capacitor's value and decreasing the ESR reduces the transient under/overshoot.

Input-Output (Dropout) Voltage

A regulator's minimum input-to-output voltage differential (dropout voltage) determines the lowest useable input supply voltage. Once the linear regulator reaches dropout, the series pass transistor is fully on and regulation ceases. The output voltage tracks the input voltage as the input voltage drops lower. Because the MAX8890 uses P-channel MOSFET pass transistors, its dropout voltage is a function of the MOSFET's drain-to-source on-resistance ($R_{\text{DS(ON)}}$) multiplied by the load current (see *Typical Operating Characteristics*):

$$V_{\text{DROPOUT}} = V_{\text{IN}_-} - V_{\text{OUT}_-} = R_{\text{DS(ON)}} \times I_{\text{OUT}_-}$$

Integrated Cellular RF-Section Power-Management IC

Pin Configuration

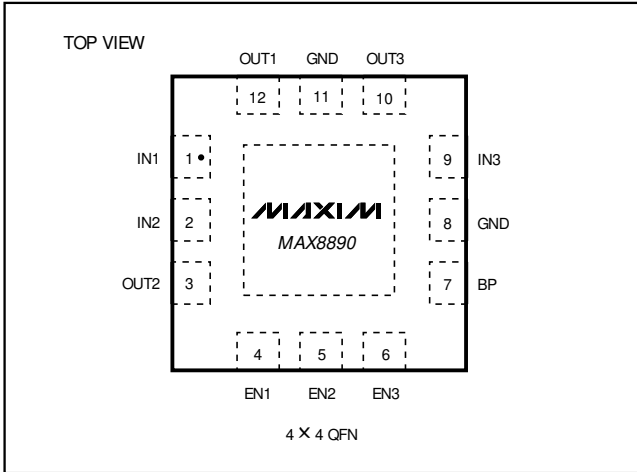

Standard Versions

VERSION	TOP MARK
MAX8890ETCAAA	AABG
MAX8890ETCDDD	AABH
MAX8890ETCGGG	AABI
MAX8890ETCMMM	AABJ
MAX8890ETCAKM	AABK
MAX8890ETCABK	AABN

Chip Information

TRANSISTOR COUNT: 1472

PROCESS: BiCMOS

Integrated Cellular RF-Section Power-Management IC

Package Information (continued)

(The package drawing(s) in this data sheet may not reflect the most current specifications. For the latest package outline information, go to www.maxim-ic.com/packages.)

Maxim cannot assume responsibility for use of any circuitry other than circuitry entirely embodied in a Maxim product. No circuit patent licenses are implied. Maxim reserves the right to change the circuitry and specifications without notice at any time.

12 _____ **Maxim Integrated Products, 120 San Gabriel Drive, Sunnyvale, CA 94086 408-737-7600**



[WHAT'S NEW](#)
[PRODUCTS](#)
[SOLUTIONS](#)
[DESIGN](#)
[APPNOTES](#)
[SUPPORT](#)
[BUY](#)
[COMPANY](#)
[MEMBERS](#)

MAX8890

Part Number Table

Notes:

1. See the [MAX8890 QuickView Data Sheet](#) for further information on this product family or download the [MAX8890 full data sheet](#) (PDF, 240kB).
2. Other options and links for purchasing parts are listed at: <http://www.maxim-ic.com/sales>.
3. [Didn't Find What You Need?](#) Ask our applications engineers. Expert assistance in finding parts, usually within one business day.
4. Part number suffixes: T or T&R = tape and reel; + = RoHS/lead-free; # = RoHS/lead-exempt. More: See [full data sheet](#) or [Part Naming Conventions](#).
5. * Some packages have variations, listed on the drawing. "PkgCode/Variation" tells which variation the product uses.

Part Number	Free Sample	Buy Direct	Package: TYPE PINS SIZE DRAWING CODE/VAR *	Temp	RoHS/Lead-Free? Materials Analysis
MAX8890ETCJJJ+T	<input type="checkbox"/>	<input type="checkbox"/>		-40C to +85C	RoHS/Lead-Free: Yes
MAX8890ETCJJJ	<input type="checkbox"/>	<input type="checkbox"/>	THIN QFN;12 pin;4X4X0.8mm Dwg: 21-0139E (PDF) Use pkgcode/variation: T1244-4*	-40C to +85C	RoHS/Lead-Free: No Materials Analysis
MAX8890ETCJJJ-T	<input type="checkbox"/>	<input type="checkbox"/>	THIN QFN;12 pin;4X4X0.8mm Dwg: 21-0139E (PDF) Use pkgcode/variation: T1244-4*	-40C to +85C	RoHS/Lead-Free: No Materials Analysis
MAX8890ETCAAA+T	<input type="checkbox"/>	<input type="checkbox"/>		-40C to +85C	RoHS/Lead-Free: Yes
MAX8890ETCAAA+	<input type="checkbox"/>	<input type="checkbox"/>	THIN QFN;12 pin;4X4X0.8mm Dwg: 21-0139E (PDF) Use pkgcode/variation: T1244+4*	-40C to +85C	RoHS/Lead-Free: Yes Materials Analysis
MAX8890ETCJJJ+	<input type="checkbox"/>	<input type="checkbox"/>	THIN QFN;12 pin;4X4X0.8mm Dwg: 21-0139E (PDF) Use pkgcode/variation: T1244+4*	-40C to +85C	RoHS/Lead-Free: Yes Materials Analysis
MAX8890ETCABK+T	<input type="checkbox"/>	<input type="checkbox"/>	THIN QFN;12 pin;4X4X0.8mm Dwg: 21-0139E (PDF) Use pkgcode/variation: T1244+4*	-40C to +85C	RoHS/Lead-Free: Yes Materials Analysis

MAX8890ETCABK+			THIN QFN;12 pin;4X4X0.8mm Dwg: 21-0139E (PDF) Use pkgcode/variation: T1244+4*	-40C to +85C	RoHS/Lead-Free: Yes Materials Analysis
MAX8890ETCDDD+T			THIN QFN;12 pin;4X4X0.8mm Dwg: 21-0139E (PDF) Use pkgcode/variation: T1244+4*	-40C to +85C	RoHS/Lead-Free: Yes Materials Analysis
MAX8890ETCDDD+			THIN QFN;12 pin;4X4X0.8mm Dwg: 21-0139E (PDF) Use pkgcode/variation: T1244+4*	-40C to +85C	RoHS/Lead-Free: Yes Materials Analysis
MAX8890ETCMMM-T			THIN QFN;12 pin;4X4X0.8mm Dwg: 21-0139E (PDF) Use pkgcode/variation: T1244-4*	-40C to +85C	RoHS/Lead-Free: No Materials Analysis
MAX8890ETCMMM			THIN QFN;12 pin;4X4X0.8mm Dwg: 21-0139E (PDF) Use pkgcode/variation: T1244-4*	-40C to +85C	RoHS/Lead-Free: No Materials Analysis
MAX8890ETCAAA-T				-40C to +85C	RoHS/Lead-Free: No
MAX8890ETCAKM			THIN QFN;12 pin;4X4X0.8mm Dwg: 21-0139E (PDF) Use pkgcode/variation: T1244-4*	-40C to +85C	RoHS/Lead-Free: No Materials Analysis
MAX8890ETCAKM-T				-40C to +85C	RoHS/Lead-Free: No
MAX8890ETCBBB			THIN QFN;12 pin;4X4X0.8mm Dwg: 21-0139E (PDF) Use pkgcode/variation: T1244-4*	-40C to +85C	RoHS/Lead-Free: No Materials Analysis
MAX8890ETCBBB-T			THIN QFN;12 pin;4X4X0.8mm Dwg: 21-0139E (PDF) Use pkgcode/variation: T1244-4*	-40C to +85C	RoHS/Lead-Free: No Materials Analysis
MAX8890ETCDDD			THIN QFN;12 pin;4X4X0.8mm Dwg: 21-0139E (PDF) Use pkgcode/variation: T1244-4*	-40C to +85C	RoHS/Lead-Free: No Materials Analysis
MAX8890ETCDDD-T			THIN QFN;12 pin;4X4X0.8mm Dwg: 21-0139E (PDF) Use pkgcode/variation: T1244-4*	-40C to +85C	RoHS/Lead-Free: No Materials Analysis
MAX8890ETCGGG			THIN QFN;12 pin;4X4X0.8mm Dwg: 21-0139E (PDF) Use pkgcode/variation: T1244-4*	-40C to +85C	RoHS/Lead-Free: No Materials Analysis
MAX8890ETCGGG-T				-40C to +85C	RoHS/Lead-Free: No
MAX8890ETCAAA			THIN QFN;12 pin;4X4X0.8mm Dwg: 21-0139E (PDF) Use pkgcode/variation: T1244-4*	-40C to +85C	RoHS/Lead-Free: No Materials Analysis

[Didn't Find What You Need?](#)

[CONTACT US: SEND US AN EMAIL](#)

Copyright 2007 by Maxim Integrated Products, Dallas Semiconductor • [Legal Notices](#) • [Privacy Policy](#)