



CMM24513S4

4-Part MIMO Ceiling Mount Antenna 2400-2500 MHz/5150-5875 MHz

The CMM24513S4 is a four-port MIMO indoor wideband omnidirectional ceiling mount antenna. It is designed to provide pattern coverage that is optimized for indoor coverage requirements at 2400-2500 MHz and 5150-5875 MHz. The antenna features a pattern that is specifically shaped to provide optimal performance from a ceiling mount location. The pattern is also very uniform and symmetrical, providing system integrators with the ability to precisely determine cell size.

FEATURES AND BENEFITS

- Low profile aesthetically neutral housing
- Mounts directly and easily to ceiling tile
- Performance optimized using Laird proprietary RF optimization tools
- 2D barcode QR labeling for easy smart phone access to antenna performance data
- Uniform and symmetrical radiation pattern delivers optimum performance

APPLICATIONS

- Office complexes and conference rooms
- Hotels, auditoriums, convention centers
- Airports, bus terminals, train stations
- Museums, libraries, theaters
- Retail stores and malls
- Casinos and entertainment venues

ELECTRICAL SPECIFICATIONS

Antenna Model	CMM24513S4	
Number of Ports	4	
Operating Frequency (MHz)	2400-2500	5150-5875
Gain (dBi)	2.9	3.3
Efficiency (%)	73	89
VSWR - Max	2.0:1	
Nominal Impedance (Ohms)	50	
Max Power - Ambient 25°C (W)	2	
Polarization	Linear, vertical	
Vertical Plane 3 dB Beamwidth Port 1	68°	
Horizontal Plane 3 dB Beamwidth Port 1	Omnidirectional	

MECHANICAL SPECIFICATIONS

Dimensions - W x H - mm (inches)	Ø218.7 x 43.5 (8.61 x 1.71)
Weight - kg (lbs.)	0.5 (17.64)
Cable Type	RG58, Plenum-rated
Radome Material	ASA (white)
Mounting	Ceiling grid/Suspended tile

ENVIRONMENTAL SPECIFICATIONS

Operating Environment (Indoor or Outdoor)	Indoor
Operating Temperature - °C (°F)	-30 to +70°C (-22 to +158°F)
Storage Temperature - °C (°F)	-30 to +70°C (-22 to +158°F)
Material Substance Compliance	RoHS

CONFIGURATION

PART NUMBER	CABLE STRENGTH	CONNECTOR
CMM24513S4-91RTN	(36.0 ± 0.59 in.)	4 x Reverse Polarity TNC Male
CMM24513S4-91RSM	(36.0 ± 0.59 in.)	4 x Reverse Polarity SMA Male

MECHANICAL DRAWING

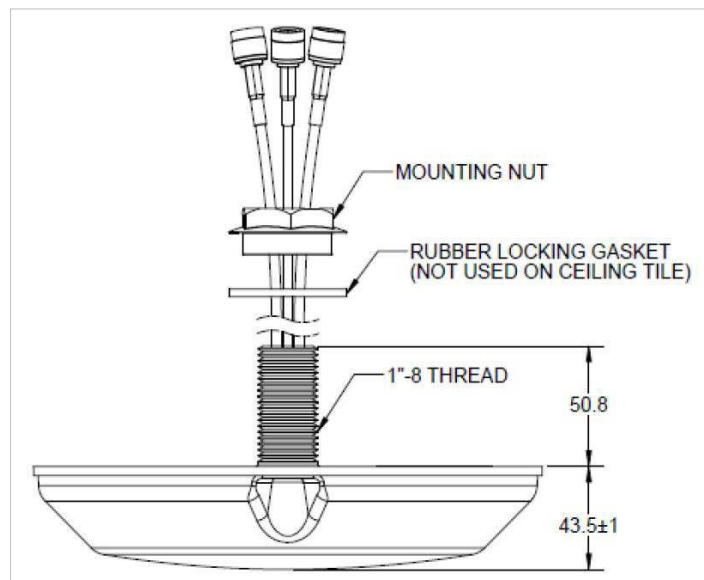

RADIATION PATTERNS

PART 1

2400 MHz

PART 2

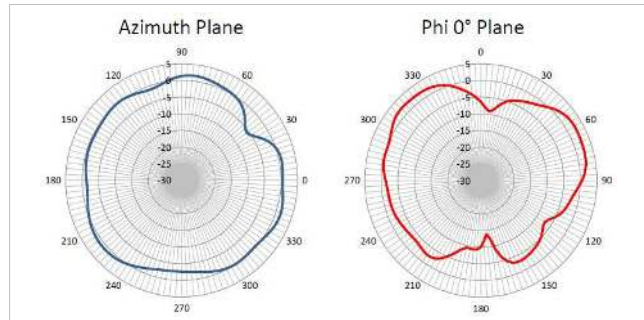
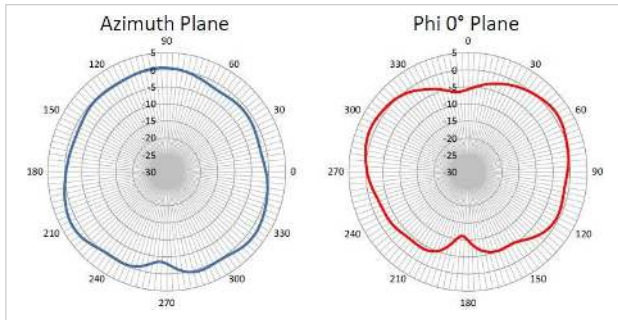

PART 1

2500 MHz

PART 2

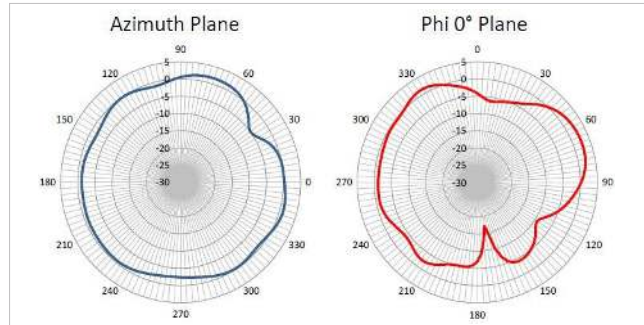
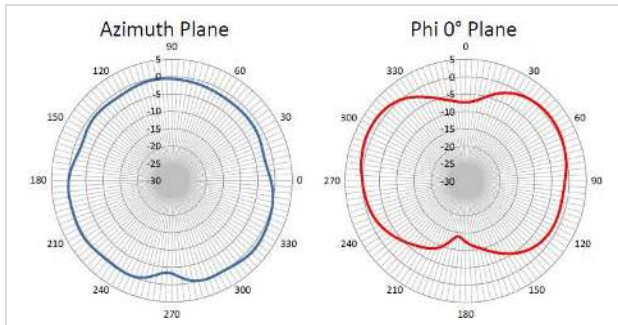

PART 1

5150 MHz

PART 2

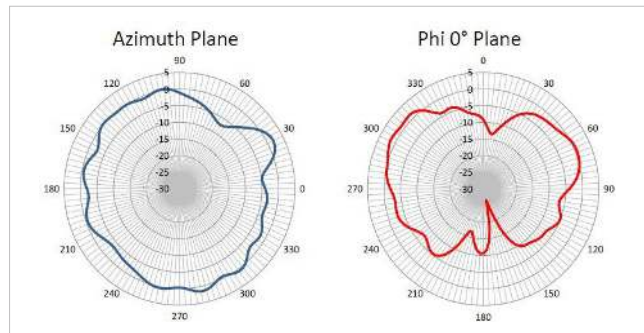
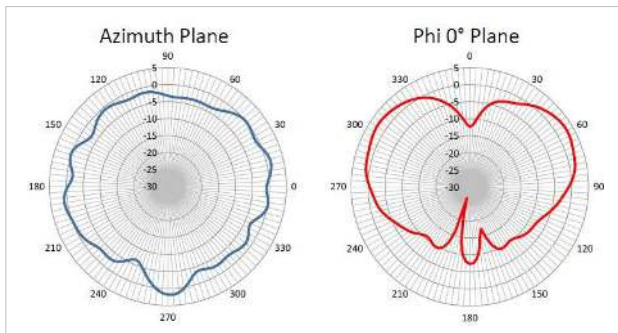

PART 1

5875 MHz

PART 2

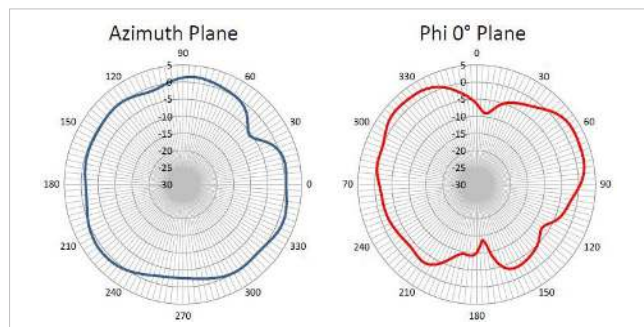
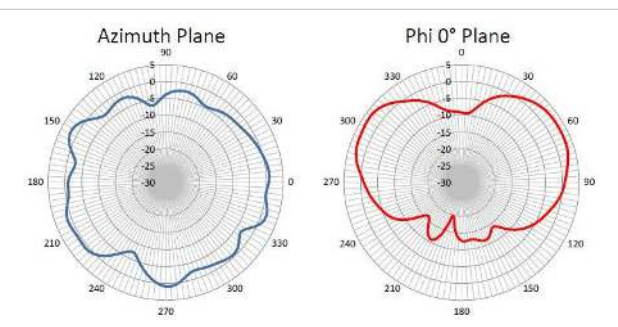

TE TECHNICAL SUPPORT CENTER

USA:	+1 (800) 522-6752
Canada:	+1 (905) 475-6222
Mexico:	+52 (0) 55-1106-0800
Latin/S. America:	+54 (0) 11-4733-2200
Germany:	+49 (0) 6251-133-1999
UK:	+44 (0) 800-267666
France:	+33 (0) 1-3420-8686
Netherlands:	+31 (0) 73-6246-999
China:	+86 (0) 400-820-6015

te.com

TE Connectivity, TE Connectivity (logo) and Every Connection Counts are trademarks. All other logos, products and/or company names referred to herein might be trademarks of their respective owners.

The information given herein, including drawings, illustrations and schematics which are intended for illustration purposes only, is believed to be reliable. However, TE Connectivity makes no warranties as to its accuracy or completeness and disclaims any liability in connection with its use. TE Connectivity's obligations shall only be as set forth in TE Connectivity's Standard Terms and Conditions of Sale for this product and in no case will TE Connectivity be liable for any incidental, indirect or consequential damages arising out of the sale, resale, use or misuse of the product. Users of TE Connectivity products should make their own evaluation to determine the suitability of each such product for the specific application.

TE warrants to the original end user customer of its products that its products are free from defects in material and workmanship. Subject to conditions and limitations TE will, at its option, either repair or replace any part of its products that prove defective because of improper workmanship or materials. This limited warranty is in force for the useful lifetime of the original end product into which the TE product is installed. Useful lifetime of the original end product may vary but is not to exceed five (5) years from the original date of the end product purchase.

©2021 TE Connectivity. All Rights Reserved.

12/21 Original

