

GlobTek, Inc. www.globtek.com 186 Veterans Drive, Northvale, NJ 07647 Tel. (201) 784-1000 Fax (201) 784-0111	Drawing Title: GT-21097-5024-4.0, ITE Power Supply, Efficiency Level: N/A, Case Color/Style: GlobTek Black, Desktop/External, Regulated Switchmode AC-DC, Input Rating: 100-240V~, 50-60 Hz, IEC 60320/C14 , Output Rating: 50W, 20V@2.5A, Output Configuration: 1830 mm, 18/2 Cond, SPT-1, Female Barrel 5.5 * 2.5 * 11mm with internal Spring Clip and Locking Notch or Equal, Ferrite: None, GlobTek Black, GT Cord # C0648, Pin Out: Center Positive (+V), Blades/Input Cord: Not Applicable, Approvals: FCC cULus CE NEMKO CCC LPS Ukraine GOST-R Class I WEEE China RoHS VCCI PSE RoHS 2 CB IP40 Korea (5V Only) Korea (12V Only) Singapore (5V only) Korea (3V Only) PSE PSE PSE PSE PSE PSE PSE PSE South Africa INDIA NOM RCM	
	Model No. GT-21097-5024-4.0	
	Part No. TR9CZ2500LCP-Y(R)	Rev D

## REVISION HISTORY

REV	DESCRIPTION	SUB	DATE	APPROVED
D	Update to SF format, update approvals: add RCM, remove CSA, change UL lie # from 6D44 to 4MU8.	QA	10/21/2015	QA

In Addition to GlobTek Inc.'s renewed ISO9001:2008 - Quality Management System Certification, GlobTek Inc. is now certified to:

ISO13485:2003 - Medical Devices Quality Management System Certification  
ISO14001:2004 - Environmental Management System Certification

ISO Certificates are available online at <http://www.globtek.com/iso-certificates/>

### Customer Approval of Specification:

Please approve, sign and send back to GlobTek so we can complete order processing.

A delay in receipt of this form will delay delivery schedule.

Company Name:

Customer P/N:

Quote Number:

Date:

Authorized Representative Name:

Authorized Representative Signature:

The acceptance of this specification and use of the product described in this document indicates the acceptance and binding of the customer to Globtek terms and conditions, which supersede all other agreements, terms, and conditions (<http://en.globtek.com/terms-and-conditions/>).

### Footnote:

GlobTek Inc. will not be liable for the safety and performance of these power supplies if unauthorized access and repair occurs. End user should consult applicable UL, CSA or EN standards for proper installation instruction.

### Limitation of Use:

GlobTek product are not authorized for use as mission critical components in life support hazardous environment, nuclear or aircraft applications without prior written approval from the CEO of GlobTek Inc.

Contents of this document are subject to change without prior notice.

**RELEASED**

*By N.Frost at 1:16 pm, Oct 23, 2015*

GT-21097-5024-4.0, 50W, 20V@2.5A, Desktop/External, Regulated Switchmode AC-DC

GlobTek, Inc. www.globtek.com 186 Veterans Drive, Northvale, NJ 07647 Tel. (201) 784-1000 Fax (201) 784-0111	Drawing Title: GT-21097-5024-4.0, ITE Power Supply, Efficiency Level: N/A, Case Color/Style: GlobTek Black, Desktop/External, Regulated Switchmode AC-DC, Input Rating: 100-240V~, 50-60 Hz, IEC 60320/C14 , Output Rating: 50W, 20V@2.5A, Output Configuration: 1830 mm, 18/2 Cond, SPT-1, Female Barrel 5.5 * 2.5 * 11mm with internal Spring Clip and Locking Notch or Equal, Ferrite: None, GlobTek Black, GT Cord # C0648, Pin Out: Center Positive (+V), Blades/Input Cord: Not Applicable, Approvals: FCC cULus CE NEMKO CCC LPS Ukraine GOST-R Class I WEEE China RoHS VCCI PSE RoHS 2 CB IP40 Korea (5V Only) Korea (12V Only) Singapore (5V only) Korea (3V Only) PSE PSE PSE PSE PSE PSE PSE PSE South Africa INDIA NOM RCM	
	Model No. GT-21097-5024-4.0	
	Part No. TR9CZ2500LCP-Y(R)	Rev D

## POWER SUPPLY INFORMATION

TYPE: Desktop/External  
TECHNOLOGY: Regulated Switchmode AC-DC  
CASE COLOR: GlobTek Black  
NAMEPLATE RATED INPUT: 100-240V~, 50-60 Hz, 1.6A Max.  
INPUT CONFIG: IEC 60320/C14  
WATTS: 50.0  
VOLTS OUT: 20  
CURRENT OUT (Amps): 2.5  
BLADE/CORD INCLUDED: N/A: Not Applicable  
BLADE/CORD INSTALLED: N/A: Not Applicable  
EFFICIENCY LEVEL: N/A  
OUTPUT CONFIGURATION: 1830 mm, 18/2 Cond, SPT-1, Female Barrel 5.5 \* 2.5 \* 11mm with internal Spring Clip and Locking Notch or Equal, Ferrite: None, GlobTek Black, GT Cord # C0648  
CONNECTOR PIN OUT: Center Positive (+V)  
LABEL SPECS: Standard GT,L-1462  
PACK SPEC: Standard DT, Individually Box

### NOTES / DEVIATIONS:

DIMENSIONS ARE IN MM UNLESS SPECIFIED OTHERWISE.

## ELECTRICAL SPECIFICATIONS

### A) ELECTRICAL SPECIFICATIONS:

01. Input Voltage: Specified 90-264 Vac, Nameplate rated: 100-240Vac
02. Input Frequency: Specified 47-63 Hz, Nameplate rated 50-60Hz
03. Output Regulation: +/-5% measured at the output connector
04. Line Voltage Regulation: +/- 1% typical measured at full load
05. Output Ripple (Vp-p): +/- 1% of output voltage, Vp-p, typical
06. Turn-ON/OFF: 5% maximum, 1 mS typical recovery time for 25% step load
07. Turn-ON Delay: 1 Sec, typical
08. Hold-Up Time: 10 mS typical @ nominal input voltage and full load
09. Inrush Current: 20A maximum cold start @ 240Vac input
10. Switching Frequency: 100 KHz typical, varies with line and load

### B) PROTECTION

01. Over-Voltage: limited via crowbar method
02. Short Circuit: Hiccup with auto recovery upon removal of short
03. Over-load: Hiccup with auto recovery
04. Input Protection: Input line

### C) SAFETY

01. Dielectric Withstand Voltage: 4242 Vdc from primary to secondary (for Class II with functional ground)
02. Touch Current: <0.25mA @ 240Vac input voltage
03. Earth Leakage Current: <3.5 mA at 240Vac input voltage
04. Earth continuity test:<0.1 Ohm or < 0.2 Ohm when with a non-detachable Power Supply cord, Class I Only
05. ROHS 2: Complies with EU 2011/65/EU and China SJ/T 11363-2006

### D) OTHER:

01. MTBF: 200,000 Hours @ 25°C ambient temperature

## PROPRIETARY INFORMATION

PROPRIETARY OF GLOBTEK, INC. ANY REPRODUCTION, DISCLOSURE OR USE OF THIS DRAWING, IN WHOLE OR IN PART, IS HEREBY PROHIBITED EXCEPT AS SPECIFIED IN WRITING BY GLOBTEK, INC.

QA /10/23/2015 12:14:42 PM

GlobTek, Inc.  
 www.globtek.com  
 186 Veterans Drive,  
 Northvale, NJ 07647  
 Tel. (201) 784-1000  
 Fax (201) 784-0111

Drawing Title: GT-21097-5024-4.0, ITE Power Supply, Efficiency Level: N/A, Case Color/Style: GlobTek Black, Desktop/External, Regulated Switchmode AC-DC, Input Rating: 100-240V~, 50-60 Hz, IEC 60320/C14 , Output Rating: 50W, 20V@2.5A, Output Configuration: 1830 mm, 18/2 Cond, SPT-1, Female Barrel 5.5 \* 2.5 \* 11mm with internal Spring Clip and Locking Notch or Equal, Ferrite: None, GlobTek Black, GT Cord # C0648, Pin Out: Center Positive (+V), Blades/Input Cord: Not Applicable, Approvals: FCC cULus CE NEMKO CCC LPS Ukraine GOST-R Class I WEEE China RoHS VCCI PSE RoHS 2 CB IP40 Korea (5V Only) Korea (12V Only) Singapore (5V only) Korea (3V Only) PSE PSE PSE PSE PSE PSE PSE PSE South Africa INDIA NOM RCM

Model No. GT-21097-5024-4.0

Part No. TR9CZ2500LCP-Y(R)

Rev D

- 02. Operating Temperature: 0°C to 40°C ambient temperature
- 03. Humidity: 0% to 90% relative humidity
- 04. Storage Temperature: -10°C to 80°C
- 05. Cooling: Convection

E) ENCLOSURE

- 01. Housing: High impact plastic, 94V0 polycarbonate, non-vented
- 02. Size: 118 x 60 x 33 ± 0.5 mm
- 03. Markings: Label and/or Pad Printed and/or Molded in the case
- 04. Green LED for indicating Power Out

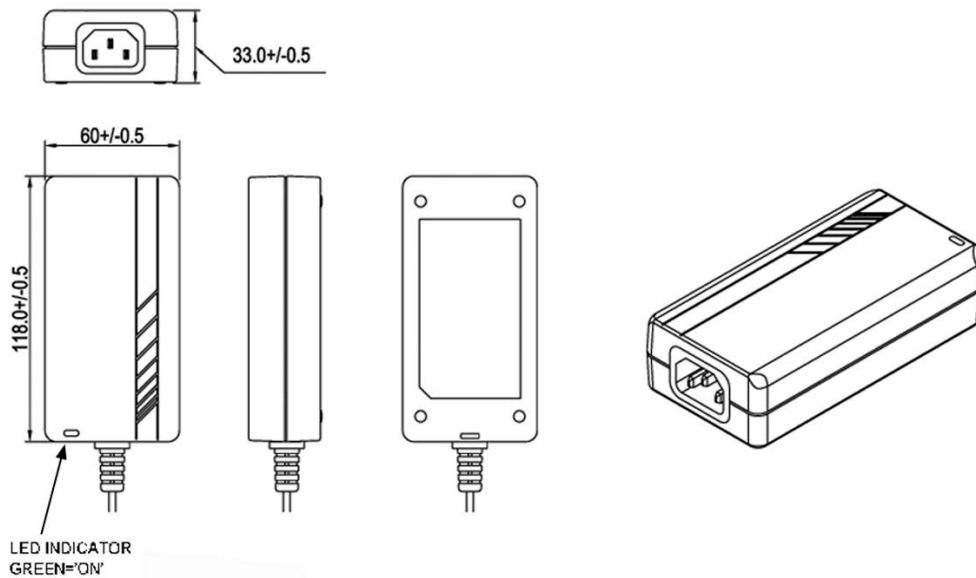

GlobTek, Inc. www.globtek.com 186 Veterans Drive, Northvale, NJ 07647 Tel. (201) 784-1000 Fax (201) 784-0111	Drawing Title: GT-21097-5024-4.0, ITE Power Supply, Efficiency Level: N/A, Case Color/Style: GlobTek Black, Desktop/External, Regulated Switchmode AC-DC, Input Rating: 100-240V~, 50-60 Hz, IEC 60320/C14 , Output Rating: 50W, 20V@2.5A, Output Configuration: 1830 mm, 18/2 Cond, SPT-1, Female Barrel 5.5 * 2.5 * 11mm with internal Spring Clip and Locking Notch or Equal, Ferrite: None, GlobTek Black, GT Cord # C0648, Pin Out: Center Positive (+V), Blades/Input Cord: Not Applicable, Approvals: FCC cULus CE NEMKO CCC LPS Ukraine GOST-R Class I WEEE China RoHS VCCI PSE RoHS 2 CB IP40 Korea (5V Only) Korea (12V Only) Singapore (5V only) Korea (3V Only) PSE PSE PSE PSE PSE PSE PSE PSE South Africa INDIA NOM RCM	
	Model No. GT-21097-5024-4.0	
	Part No. TR9CZ2500LCP-Y(R)	Rev D

## INPUT CONFIGURATION

Blades/Cord Included: N/A: Not Applicable  
 Blades/Cord Installed: N/A: Not Applicable

IEC 60320/C14 AC Inlet Connector, Class I, Earth Ground

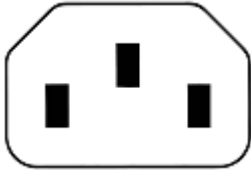

Mates with IEC 60320/C13 Plug

### [Standard International IEC 320/C13 Cordsets](#)

Below are standard cordsets which are "not included" (unless stated above); these can be purchased separately or packaged with the power supply. Contact your Sales Engineer if the style required is not shown below. Many more available in different lengths, colors or cable material.

GlobTek P/N	Length	Country	Description
1191063F0701(R) to IEC 320/C13	3 FT	North American Hospital	3 CONDUCTOR: SJT 18/3, 3 Ft., BLACK, UL/CSA, HOSPITAL NEMA 5-15P
1191068F0701(R) to IEC 320/C13	8 FT	North American Hospital	3 CONDUCTOR: SJT 18/3, 8 Ft., BLACK, UL/CSA, HOSPITAL NEMA 5-15P
3021453F701(R) 320/C13	3 FT	North American	3 CONDUCTOR: SVT 18/3, 3', BLACK, UL/CSA, NEMA 5-15P to IEC
<b>3021457F701(R) 320/C13</b>	<b>7 FT</b>	<b>North American</b>	<b>3 CONDUCTOR: SVT 18/3, 7', BLACK, UL/CSA, NEMA 5-15P to IEC</b>
3021876F7701(R) to IEC 320/C13	7 FT	North American	3 CONDUCTOR: SVT, Shielded, 18/3, 6' 7", BLACK, UL/CSA, NEMA 5-15P
23144272M5701-T(R)	2.5 M	European	3 CONDUCTOR H05VVF, 3x1.00, 2.5M, CEE 7/7 to IEC 320/C13
PZ0800100-2M5BK13-H(R)	2.5 M	UK / Ireland	3 CONDUCTOR: H05VVF, 3x1.0, 2.5M, BSI, BS1363 to IEC 320/C13
5502022M5701A(R)	2.5 M	Australia	3 CONDUCTOR: GTSA 3x1.0, 2.5M, SAA, AS3112 to IEC 320/C13
3003068F2701-HK(R)	2.5 M	Japan	3 CONDUCTOR: VCTF, 3x 2.0, 2.5M, PSE, JIS8303 to IEC 320/C13
23214272M5701(R)	2.5 M	Swiss	3 CONDUCTOR: H05VVF 3x1.0, 2.5M, SEV, SEV 1011 to IEC 320/C13
23024272M5701(R) 320/C13	2.5 M	Italy	3 CONDUCTOR: H05VVF 3x 1.00, 2.5M, IMQ, CEI 23-16/VII to IEC
G8014272M5701(R) 320/C13	2.5 M	Demark	3 CONDUCTOR: H05VVF 3x 1.00, 2.5M, D, AFSNIT 107-2-D1 to IEC
2084272M5701(R)	2.5 M	India/ Africa	3 CONDUCTOR: H05VVF 3x1.0, 2.5M, BS546 to IEC 320/C13
6023602M5701(R) 320/C13	2.5 M	China	3 CONDUCTOR: RVV, 3X1.0mm <sup>2</sup> , 2.5M, CCC, GB2099.1 (1996) to IEC
377C4272M5701(R)	2.5 M	Israel	3 CONDUCTOR: H05VVF 3x 1.00, 2.5M, ISRAEL SI-32 to IEC 320/C13
7055002M5701(R)	2.5 M	International	3 CONDUCTOR: H05VVF 3x 1.00, 2.5M, IEC320/C14 to IEC 320/C13

GlobTek, Inc.  
 www.globtek.com  
 186 Veterans Drive,  
 Northvale, NJ 07647  
 Tel. (201) 784-1000  
 Fax (201) 784-0111

Drawing Title: GT-21097-5024-4.0, ITE Power Supply, Efficiency Level: N/A, Case Color/Style: GlobTek Black, Desktop/External, Regulated Switchmode AC-DC, Input Rating: 100-240V~, 50-60 Hz, IEC 60320/C14 , Output Rating: 50W, 20V@2.5A, Output Configuration: 1830 mm, 18/2 Cond, SPT-1, Female Barrel 5.5 \* 2.5 \* 11mm with internal Spring Clip and Locking Notch or Equal, Ferrite: None, GlobTek Black, GT Cord # C0648, Pin Out: Center Positive (+V), Blades/Input Cord: Not Applicable, Approvals: FCC cULus CE NEMKO CCC LPS Ukraine GOST-R Class I WEEE China RoHS VCCI PSE RoHS 2 CB IP40 Korea (5V Only) Korea (12V Only) Singapore (5V only) Korea (3V Only) PSE PSE PSE PSE PSE PSE PSE PSE South Africa INDIA NOM RCM

Model No. GT-21097-5024-4.0

Part No. TR9CZ2500LCP-Y(R)

Rev D

**OUTPUT CORD AND CONNECTOR: LCL/C0648**

ACTUAL CONNECTORS, OVERMOLDS, FERRITES MAY VARY SLIGHTLY FROM THE PICTURE BELOW

CABLE TYPE	SPT-1
CABLE LENGTH (mm)	1830
CABLE TOLERANCE (mm)	+100-0
WIRE GAUGE (AWG)	18
CONDUCTORS	2
HANK DIMENSION (mm)	120 +15 -15
CABLE / CONNECTOR OVERMOLD COLOR	GlobTek Black
FERRITE TYPE / DIMENSION	None
FERRITE # OF TURNS ( <a href="#">Definition</a> )	N/A
FERRITE DIMENSION FROM STRAIN RELIEF	N/A
FERRITE DIMENSION FROM PLUG	N/A
PLUG TYPE	Female Barrel 5.5 * 2.5 * 11mm with internal Spring Clip and Locking Notch or Equal
OVER MOLD ORIENTATION	Straight
CONNECTOR PIN OUT:	Center Positive (+V)

**ADDITIONAL REQUIREMENTS**

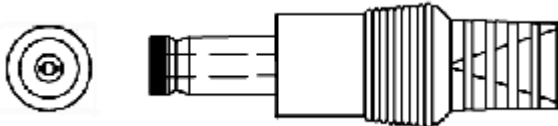

Internal view:

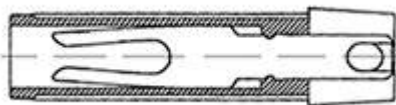

ADDITIONAL OUTPUT PLUG OPTIONS ARE AVAILABLE AT <http://www.globtek.com/connectors.php>  
 STANDARD PLUGS AND CONNECTORS CAN BE SEEN ONLINE AT <http://www.globtek.com/connectors.php>

GlobTek, Inc. www.globtek.com 186 Veterans Drive, Northvale, NJ 07647 Tel. (201) 784-1000 Fax (201) 784-0111	Drawing Title: GT-21097-5024-4.0, ITE Power Supply, Efficiency Level: N/A, Case Color/Style: GlobTek Black, Desktop/External, Regulated Switchmode AC-DC, Input Rating: 100-240V~, 50-60 Hz, IEC 60320/C14 , Output Rating: 50W, 20V@2.5A, Output Configuration: 1830 mm, 18/2 Cond, SPT-1, Female Barrel 5.5 * 2.5 * 11mm with internal Spring Clip and Locking Notch or Equal, Ferrite: None, GlobTek Black, GT Cord # C0648, Pin Out: Center Positive (+V), Blades/Input Cord: Not Applicable, Approvals: FCC cULus CE NEMKO CCC LPS Ukraine GOST-R Class I WEEE China RoHS VCCI PSE RoHS 2 CB IP40 Korea (5V Only) Korea (12V Only) Singapore (5V only) Korea (3V Only) PSE PSE PSE PSE PSE PSE PSE PSE South Africa INDIA NOM RCM	
	Model No. GT-21097-5024-4.0	
	Part No. TR9CZ2500LCP-Y(R)	Rev D

**LABEL:L-1462**

LABEL P/N: Standard GT  
 MATERIAL: Flat Thermal Transfer, Imprintable, Polyester Label and/or Pad Printed and/or Molded, and/or Laser Engraved in the case  
 BACKGROUND COLOR: Black  
 TEXT COLOR: White or Silver or Gray  
 LABEL WIDTH (mm): 44.5  
 LABEL HEIGHT (mm): 79.5

Below is the minimum information which will appear on the label. NOTE: in the logo area additional/actual positioning of symbols and text is subjected to change as per agency updates/requirements or additional model approvals become available.

Regulatory certifications/label markings may be in logo area on the label or molded into the case housing outside the label area. Information will be shown via label and/or pad printed and/or molded and/or laser engraved in the case. \* Date code markings at GlobTek option.

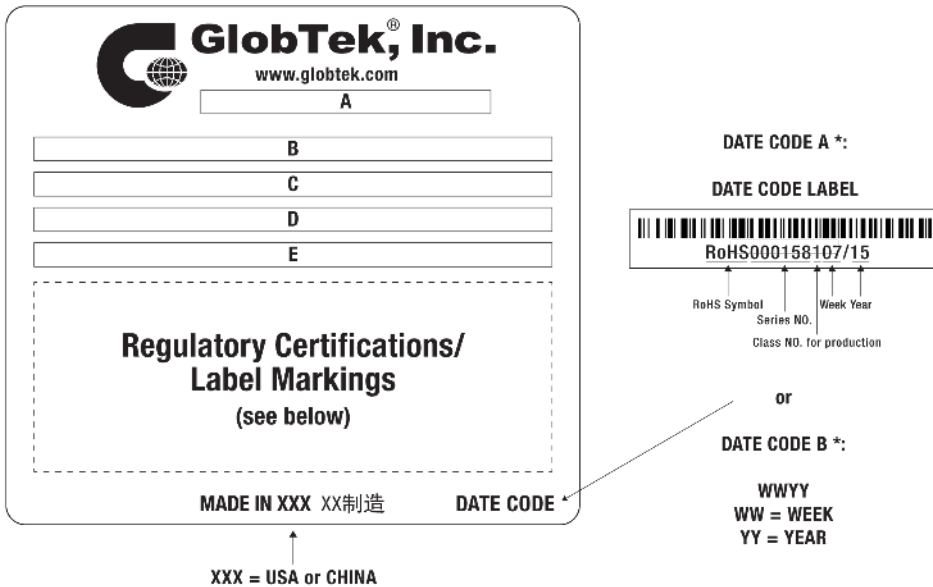

- A=ITE Power Supply
- B=P/N: (料号) TR9CZ2500LCP-Y(R)
- C=Model (型号) GT-21097-5024-4.0
- D=Input (输入) 100-240V~, 50-60 Hz, 1.6A Max.
- E=Output (産出) 20 V 2.5 A

AGENCY ONLINE DOCUMENTS <http://www.globtek.info/certs/GT-21097>













IPXY rating is based on 3rd party testing and customers should check suitability and test system level IPXY rating before ordering.

**Regulatory Certifications/Label Markings**

GlobTek, Inc. www.globtek.com 186 Veterans Drive, Northvale, NJ 07647 Tel. (201) 784-1000 Fax (201) 784-0111	Drawing Title: GT-21097-5024-4.0, ITE Power Supply, Efficiency Level: N/A, Case Color/Style: GlobTek Black, Desktop/External, Regulated Switchmode AC-DC, Input Rating: 100-240V~, 50-60 Hz, IEC 60320/C14 , Output Rating: 50W, 20V@2.5A, Output Configuration: 1830 mm, 18/2 Cond, SPT-1, Female Barrel 5.5 * 2.5 * 11mm with internal Spring Clip and Locking Notch or Equal, Ferrite: None, GlobTek Black, GT Cord # C0648, Pin Out: Center Positive (+V), Blades/Input Cord: Not Applicable, Approvals: FCC cULus CE NEMKO CCC LPS Ukraine GOST-R Class I WEEE China RoHS VCCI PSE RoHS 2 CB IP40 Korea (5V Only) Korea (12V Only) Singapore (5V only) Korea (3V Only) PSE PSE PSE PSE PSE PSE PSE PSE South Africa INDIA NOM RCM	
	Model No. GT-21097-5024-4.0	
	Part No. TR9CZ2500LCP-Y(R)	Rev D

Logo	Description
	Attention Mark / Refer to operating manual for operating and service instructions
No Logo	Bureau Of Indian Standards CB Certificate IEC 60950-1:2005 (2nd Edition), Am 1: 2009, CB report IEC 60950-1:2005 (2nd Edition), Am 1: 2009 and EN 60950-1:2006 + Am 1:2010 + Am 11:2009 + Am 12:2011
	CCC to GB4943.1-2011 GB9254-2008 GB17625.1-2012
	CE Mark: tested to comply with EN55022:2006/A1:2007 Class B, EN610003-2, EN610003-3 including EN61000-4-2, EN61000-4-3, EN61000-4-4, EN61000-4-5, EN61000-4-6N EN61000-4-11; EMI: Complies with EN55011 CLASS B and FCC Part 15B - On label or Molded in case
	CHINA SJ/T 11364-2014, China RoHS Chart: <a href="http://en.globtek.com/globtek-rohs.php">http://en.globtek.com/globtek-rohs.php</a>
	Class I Earth Ground
	UL60950-1, cULus to UL 60950-1, 2nd Edition, 2007-03-27 and CSA C22.2 No. 60950-1-07, 2nd Edition, 2007-03
	FCC PART 15 CLASS B
	GOST-R mark for Russia(Document: <a href="http://www.globtek.com/html/iso_certificates/GT_GOST-R.pdf">http://www.globtek.com/html/iso_certificates/GT_GOST-R.pdf</a> ). 03/15/2015. Due to lack of demand, GlobTek will not be renewing it's GOST certification. Please contact your sales engineer for pricing on EAC.
expired (do not use)	
	Indoor Use Only - Mark is on the label or Molded in the case
IP40	Ingress Protection: IP40 to IEC60529:2001 Protection against granular foreign bodies
	JAPAN TUV R-PSE, Cert. No. JD 50313285, to J60950-1(H26) , J55022(H22),J3000(H25)[15V or less]. Please reference the following website for guidelines on PSE regulations: <a href="http://en.globtek.com/importing-ite-and-medical-power-supplies-ac-adaptors-to-japan/">http://en.globtek.com/importing-ite-and-medical-power-supplies-ac-adaptors-to-japan/</a>
GlobTek, Inc.	
	JAPAN TUV R-PSE, Cert. No. JD 50313287, to J60950-1(H26) , J55022(H22),J3000(H25)[15V or less]. Please reference the following website for guidelines on PSE regulations: <a href="http://en.globtek.com/importing-ite-and-medical-power-supplies-ac-adaptors-to-japan/">http://en.globtek.com/importing-ite-and-medical-power-supplies-ac-adaptors-to-japan/</a>
GlobTek, Inc.	
	JAPAN TUV R-PSE, Cert. No. JD 50313287, to J60950-1(H26) , J55022(H22),J3000(H25)[DC30≤60V]. Please reference the following website for guidelines on PSE regulations: <a href="http://en.globtek.com/importing-ite-and-medical-power-supplies-ac-adaptors-to-japan/">http://en.globtek.com/importing-ite-and-medical-power-supplies-ac-adaptors-to-japan/</a>
GlobTek, Inc.	
	JAPAN TUV R-PSE, Cert. No. JD 50314475, to J60950-1(H26) , J55022(H22),J3000(H25)[15V or less]. Please reference the following website for guidelines on PSE regulations: <a href="http://en.globtek.com/importing-ite-and-medical-power-supplies-ac-adaptors-to-japan/">http://en.globtek.com/importing-ite-and-medical-power-supplies-ac-adaptors-to-japan/</a>
GlobTek, Inc.	
	JAPAN TUV R-PSE, Cert. No. JD 50314475, to J60950-1(H26) , J55022(H22),J3000(H25)[DC15≤30V]. Please reference the following website for guidelines on PSE regulations: <a href="http://en.globtek.com/importing-ite-and-medical-power-supplies-ac-adaptors-to-japan/">http://en.globtek.com/importing-ite-and-medical-power-supplies-ac-adaptors-to-japan/</a>
GlobTek, Inc.	
	JAPAN TUV R-PSE, Cert. No. JD 50314475, to J60950-1(H26) ,

GlobTek, Inc. www.globtek.com 186 Veterans Drive, Northvale, NJ 07647 Tel. (201) 784-1000 Fax (201) 784-0111	Drawing Title: GT-21097-5024-4.0, ITE Power Supply, Efficiency Level: N/A, Case Color/Style: GlobTek Black, Desktop/External, Regulated Switchmode AC-DC, Input Rating: 100-240V~, 50-60 Hz, IEC 60320/C14 , Output Rating: 50W, 20V@2.5A, Output Configuration: 1830 mm, 18/2 Cond, SPT-1, Female Barrel 5.5 * 2.5 * 11mm with internal Spring Clip and Locking Notch or Equal, Ferrite: None, GlobTek Black, GT Cord # C0648, Pin Out: Center Positive (+V), Blades/Input Cord: Not Applicable, Approvals: FCC cULus CE NEMKO CCC LPS Ukraine GOST-R Class I WEEE China RoHS VCCI PSE RoHS 2 CB IP40 Korea (5V Only) Korea (12V Only) Singapore (5V only) Korea (3V Only) PSE PSE PSE PSE PSE PSE PSE South Africa INDIA NOM RCM	
	Model No. GT-21097-5024-4.0	
	Part No. TR9CZ2500LCP-Y(R)	Rev D

 GlobTek, Inc.  직류전원장치 AC/DC ADAPTER KTC HU10499-10005A 모델명:GT-21097-2003 Mfr. Name: GLOBTEK (SUZHOU) CO.,LTD A/S Center: 10-6221-6100	J55022(H22),J3000(H25)[DC30≤60V]. Please reference the following website for guidelines on PSE regulations: <a href="http://en.globtek.com/importing-ite-and-medical-power-supplies-ac-adaptors-to-japan/">http://en.globtek.com/importing-ite-and-medical-power-supplies-ac-adaptors-to-japan/</a>
 직류전원장치 AC/DC ADAPTER KTC HU10499-10005A 모델명:GT-21097-3005 Mfr. Name: GLOBTEK (SUZHOU) CO.,LTD A/S Center: 10-6221-6100	Korea KET KC Mark GT-21097-2003 HU10499-10005A (3V Only)
 직류전원장치 AC/DC ADAPTER KTC HU10499-10005A 모델명:GT-21097-3005 Mfr. Name: GLOBTEK (SUZHOU) CO.,LTD A/S Center: 10-6221-6100	Korea KET KC Mark GT-21097-3005 HU10499-10005A (5V Only)
 직류전원장치 AC/DC ADAPTER KTC HU10040-7022B 모델명:GT-21097-5012 Mfr. Name: GLOBTEK (SUZHOU) CO.,LTD A/S Center: 10-6221-6100	Korea KET KC Mark GT-21097-5012 HU10040-7022B (12V Only)
LPS  Apparatet må tilkoples jorden stikkontakt	Limited Power Source  Nemko w Class I Warning Nemko EN60950-1:2006, A11, A1, A12
 Fuente de alimentación de ITE	NOM (Mexico) to NOM-001-SCFI-1993 (5 Volts only)
 GlobTek, Inc.  GlobTek, Inc.	JAPAN TUV Rheinland-PSE GlobTek Inc to J60950-1(H26) , J55022(H22),J3000(H25).Please follow the procedure listed in the following link for proper import to Japan: <a href="http://en.globtek.com/importing-to-japan.php">http://en.globtek.com/importing-to-japan.php</a>
 N136 SAA-150591-EA	JAPAN TUV R-PSE, Cert. No. JD 50314475, to J60950-1(H26) , J55022(H22),J3000(H25)[15V or less]. Please reference the following website for guidelines on PSE regulations: <a href="http://en.globtek.com/importing-ite-and-medical-power-supplies-ac-adaptors-to-japan/">http://en.globtek.com/importing-ite-and-medical-power-supplies-ac-adaptors-to-japan/</a>
RoHS 2  RoHS Symbol      Serial NO.      YEAR      WEEK Class NO for production	RCM certificate SAA-150591-EA; Australia and New Zealand Regulatory Compliance, Mark ( <a href="http://rcm.standards.org.au/rcmfaq/rcmfaq.htm">http://rcm.standards.org.au/rcmfaq/rcmfaq.htm</a> )  RoHS 2: Complies with EU 2011/65/EU and CHINA SJ/T 11363-2006 <a href="http://www.ce-mark.com/Rohs%20final.pdf">http://www.ce-mark.com/Rohs%20final.pdf</a>
 092308-11	Serial Number Information  Singapore 092308-11 GT-21097-3005 To IEC 60950-1 5 volts only



GlobTek, Inc.  
 www.globtek.com  
 186 Veterans Drive,  
 Northvale, NJ 07647  
 Tel. (201) 784-1000  
 Fax (201) 784-0111

Drawing Title: GT-21097-5024-4.0, ITE Power Supply, Efficiency Level: N/A, Case Color/Style: GlobTek Black, Desktop/External, Regulated Switchmode AC-DC, Input Rating: 100-240V~, 50-60 Hz, IEC 60320/C14 , Output Rating: 50W, 20V@2.5A, Output Configuration: 1830 mm, 18/2 Cond, SPT-1, Female Barrel 5.5 \* 2.5 \* 11mm with internal Spring Clip and Locking Notch or Equal, Ferrite: None, GlobTek Black, GT Cord # C0648, Pin Out: Center Positive (+V), Blades/Input Cord: Not Applicable, Approvals: FCC cULus CE NEMKO CCC LPS Ukraine GOST-R Class I WEEE China RoHS VCCI PSE RoHS 2 CB IP40 Korea (5V Only) Korea (12V Only) Singapore (5V only) Korea (3V Only) PSE PSE PSE PSE PSE PSE PSE PSE South Africa INDIA NOM RCM

Model No. GT-21097-5024-4.0

Part No. TR9CZ2500LCP-Y(R)

Rev D

No Logo



10139



South Africa EMI and EMC approval to CISPR 22 Class B CISPR 24

Ukraine UKRSePro (Document: [www.globtek.com/html/iso\\_certificates/GT\\_Ukraine.pdf](http://www.globtek.com/html/iso_certificates/GT_Ukraine.pdf))

Japan: Voluntary Control Council for Interference (VCCI)

WEEE: Complies with EU 2012/19/EU ([http://ec.europa.eu/environment/waste/weee/index\\_en.htm](http://ec.europa.eu/environment/waste/weee/index_en.htm))

Mark is on the label or Molded in the case



Center Positive (+V)

GlobTek, Inc. www.globtek.com 186 Veterans Drive, Northvale, NJ 07647 Tel. (201) 784-1000 Fax (201) 784-0111	Drawing Title: GT-21097-5024-4.0, ITE Power Supply, Efficiency Level: N/A, Case Color/Style: GlobTek Black, Desktop/External, Regulated Switchmode AC-DC, Input Rating: 100-240V~, 50-60 Hz, IEC 60320/C14 , Output Rating: 50W, 20V@2.5A, Output Configuration: 1830 mm, 18/2 Cond, SPT-1, Female Barrel 5.5 * 2.5 * 11mm with internal Spring Clip and Locking Notch or Equal, Ferrite: None, GlobTek Black, GT Cord # C0648, Pin Out: Center Positive (+V), Blades/Input Cord: Not Applicable, Approvals: FCC cULus CE NEMKO CCC LPS Ukraine GOST-R Class I WEEE China RoHS VCCI PSE RoHS 2 CB IP40 Korea (5V Only) Korea (12V Only) Singapore (5V only) Korea (3V Only) PSE PSE PSE PSE PSE PSE PSE PSE South Africa INDIA NOM RCM	
	Model No. GT-21097-5024-4.0	
	Part No. TR9CZ2500LCP-Y(R)	Rev D

**PACKAGING**

Packing Spec P/N: Standard DT, Individually  
 Box

Box Qty: 60

Gift Box Size (mm): 147\*100\*33

Gift Box Color: White

Master Carton Size (mm): 455\*405\*220

Master GW (Kg): 19.6 kg

BLADES INCLUDED: N/A: Not Applicable

BLADE/CORD INSTALLED: N/A: Not Applicable

If specific packaging is required, this section must specify all requirements and note "no exceptions". If this section does not specify packaging, it is subject to change without notice at GlobTek's discretion

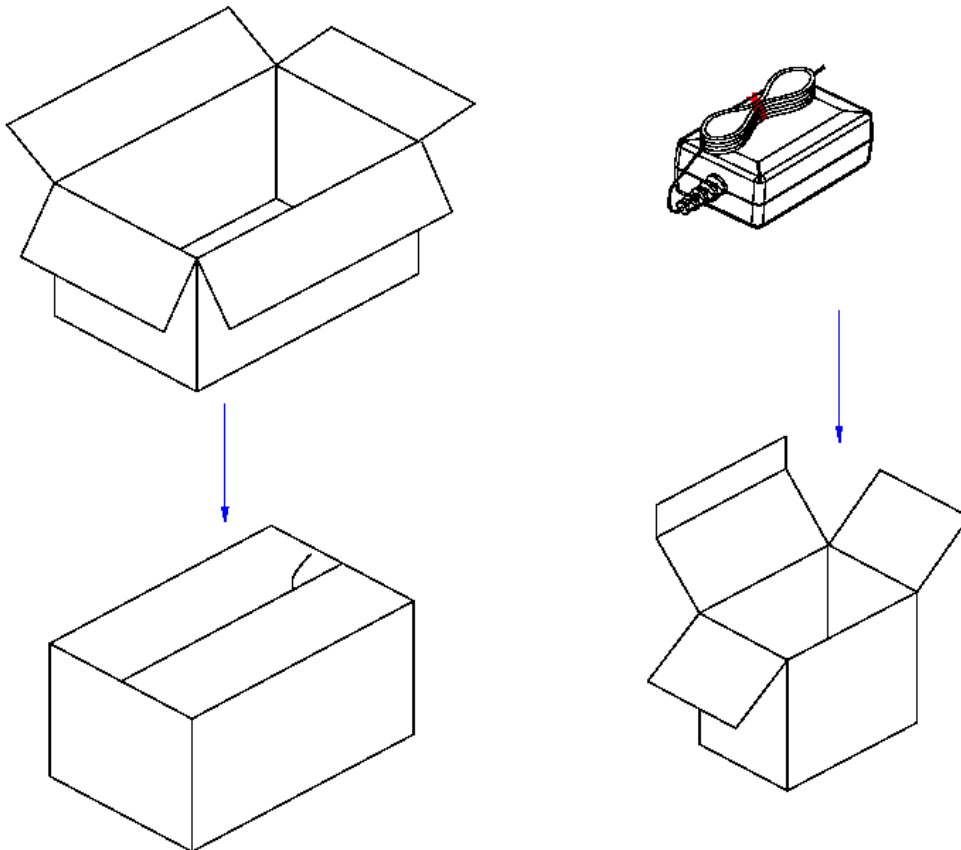

GlobTek, Inc. www.globtek.com 186 Veterans Drive, Northvale, NJ 07647 Tel. (201) 784-1000 Fax (201) 784-0111	Drawing Title: GT-21097-5024-4.0, ITE Power Supply, Efficiency Level: N/A, Case Color/Style: GlobTek Black, Desktop/External, Regulated Switchmode AC-DC, Input Rating: 100-240V~, 50-60 Hz, IEC 60320/C14 , Output Rating: 50W, 20V@2.5A, Output Configuration: 1830 mm, 18/2 Cond, SPT-1, Female Barrel 5.5 * 2.5 * 11mm with internal Spring Clip and Locking Notch or Equal, Ferrite: None, GlobTek Black, GT Cord # C0648, Pin Out: Center Positive (+V), Blades/Input Cord: Not Applicable, Approvals: FCC cULus CE NEMKO CCC LPS Ukraine GOST-R Class I WEEE China RoHS VCCI PSE RoHS 2 CB IP40 Korea (5V Only) Korea (12V Only) Singapore (5V only) Korea (3V Only) PSE PSE PSE PSE PSE PSE PSE PSE South Africa INDIA NOM RCM	
	Model No. GT-21097-5024-4.0	
	Part No. TR9CZ2500LCP-Y(R)	Rev D

INSTRUCTION SHEET

N/A