

Tous droits strictement réservés. Reproduction ou communication à des tiers sans autorisation écrite du propriétaire. Droits de reproduction BERG ELECTRONICS by

All rights strictly reserved. Reproduction or issue to third parties in any form without the written authority from the proprietor. Copyright BERG ELECTRONICS by

| PRODUCT NO. | DIM.L |
|-------------|-------|
| 94307-00** | 0.0 |
| 94307-02** | 2.0 |
| 94307-05** | 5.0 |

** : SEE TABLE I

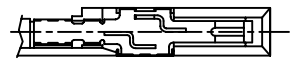

VIEW X

- NOTES:
- EJECT PLATE MOVE ALONG INSIDE WALL OF COVER PLATE SMOOTHLY AFTER ASSEMBLING WITH HDR ASS'Y.

| ** | DIM"S" | PUSH ROD COLOR |
|----|--------|----------------|
| CA | 13.0 | BLACK |
| CH | 13.0 | NATURAL |
| DA | 15.2 | BLACK |
| DH | 15.2 | NATURAL |
| EA | 18.5 | BLACK |
| EH | 18.5 | NATURAL |
| FA | 21.0 | BLACK |
| FH | 21.0 | NATURAL |

TABLE I

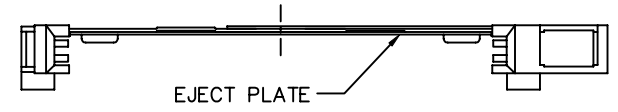
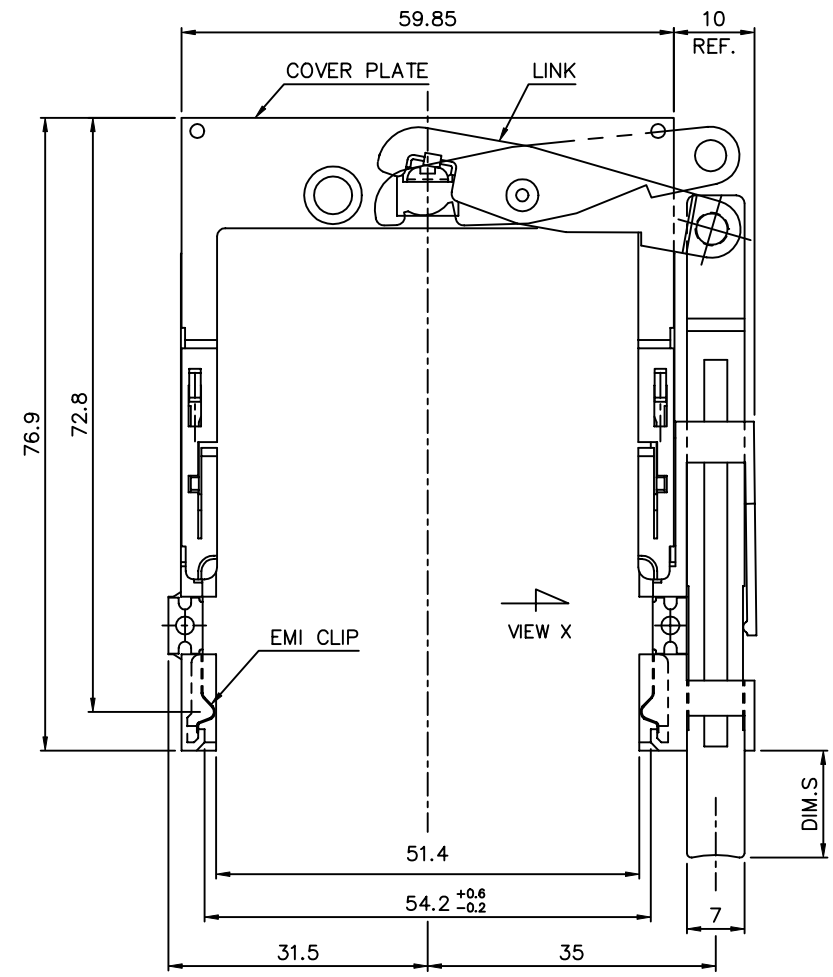
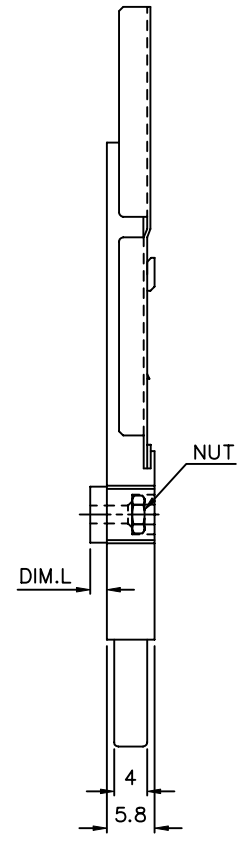

| | | | | | | | | |
|------------|----------|--------------------------------------|-------------|---------------|------------------------|----------------|---------|--------|
| mat'l code | | tolerance unless otherwise specified | | CUSTOMER COPY | FCI ELECTRONICS | | | |
| rev. | ecn no. | dr | date | linear | ±0.20 | projection | title | |
| A | T40102 | C L | 04/14/94 | | | | | |
| B | T60075 | W L | 04/18/98 | | | | | |
| C | T10375 | W L | 12/24/01 | angles | ± 2° | product family | code | |
| | | dr | C L FENG | 04/14/94 | unit | | | PCMCIA |
| | | enr | JOSEPH HSIA | 04/14/94 | mm/inch | | | |
| | | chr | JOSEPH HSIA | 04/14/94 | scale | size | dwg no. | |
| | | appd | D K WANG | 04/14/94 | 1.5:1 | | | A3 |
| sheet | revision | C | C | C | | | | sheet |
| index | sheet | 1 | 2 | 3 | 4 | | | 1 OF 4 |

Tous droits strictement réservés. Reproduction ou communication à des tiers int
 sous quelque forme que ce soit sans autorisation écrite du propriétaire.
 Property of c BERG ELECTRONICS.
 Droits de reproduction BERG ELECTRONICS by

All rights strictly reserved. Reproduction or issue to third parties in any for
 without the written authority from the proprietor.
 Property of c BERG ELECTRONICS.
 Copyright BERG ELECTRONICS by

| | |
|------------|-------|
| PRODUCT NO | DIM.L |
| 94307-10** | 0.0 |
| 94307-12** | 2.0 |
| 94307-15** | 5.0 |

** : SEE TABLE I

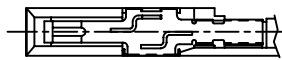

VIEW X

NOTES:

- EJECT PLATE MOVE AONG INSIDE WALL OF COVER PLATE SMOOTHLY AFTER ASSEMBLING WITH HDR ASS'Y.

| ** | DIM"S" | PUSH ROD COLOR |
|----|--------|----------------|
| CA | 13.0 | BLACK |
| CH | 13.0 | NATURAL |
| DA | 15.2 | BLACK |
| DH | 15.2 | NATURAL |
| EA | 18.5 | BLACK |
| EH | 18.5 | NATURAL |
| FA | 21.0 | BLACK |
| FH | 21.0 | NATURAL |

TABLE I

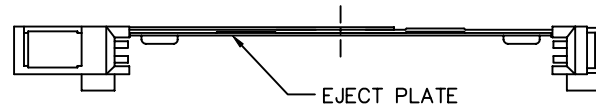
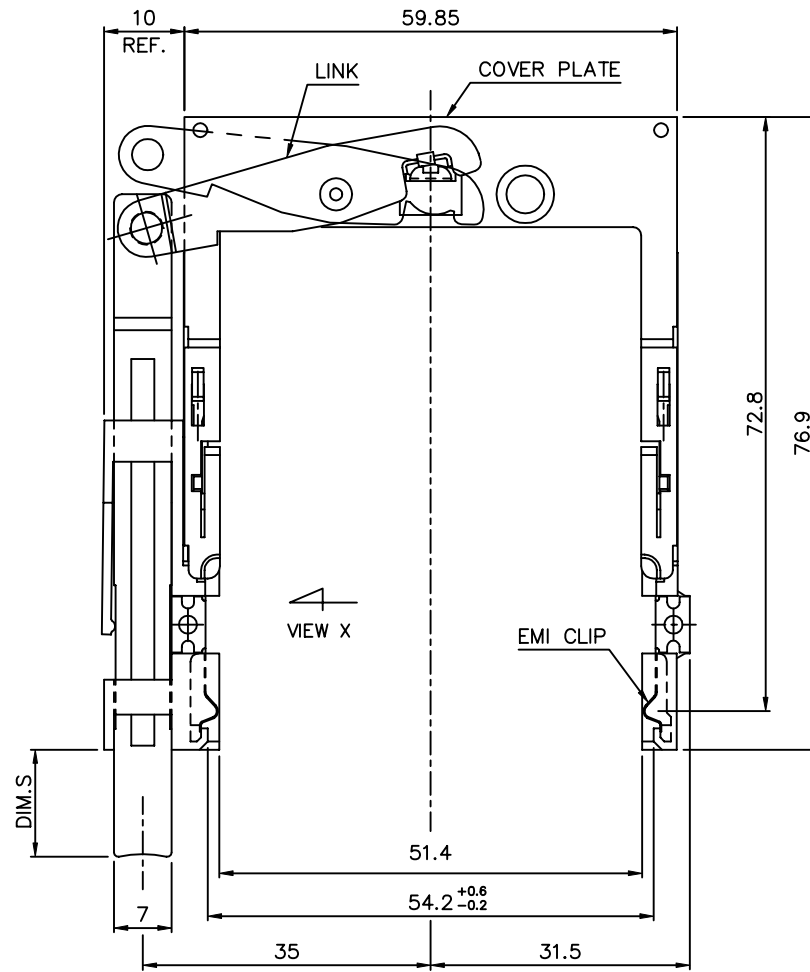
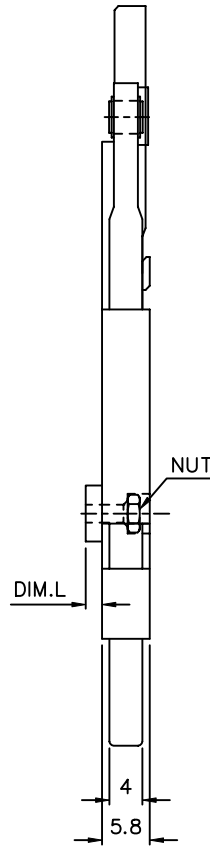

| | | | | | | |
|------------|----------|--------------------------------------|------|----------------|------------------------|------------|
| mat'l code | | tolerance unless otherwise specified | | CUSTOMER COPY | FCI ELECTRONICS | |
| rev. | ecn no. | dr | date | linear | ±0.20 | projection |
| C | | | | angles | ± 2° | title |
| | | | | dr | C L FENG 04/14/94 | unit |
| | | | | enr | JOSEPH HSIA 04/14/94 | mm/inch |
| | | | | chr | JOSEPH HSIA 04/14/94 | scale |
| | | | | appd | D K WANG 04/14/94 | 1.5:1 |
| sheet | revision | | | product family | PCMCIA | code |
| index | sheet | | | size | dwg no. | 94307 |
| | | | | scale | 1.5:1 | sheet 2 OF |

| | |
|-------------|-------|
| PRODUCT NO. | DIM.L |
| 94307-00GA | 0.0 |
| 94307-02GA | 2.0 |
| 94307-05GA | 5.0 |



VIEW X

NOTES:

- EJECT PLATE MOVE ALONG INSIDE WALL OF COVER PLATE SMOOTHLY AFTER ASSEMBLING WITH HDR ASS'Y.

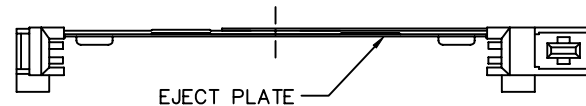
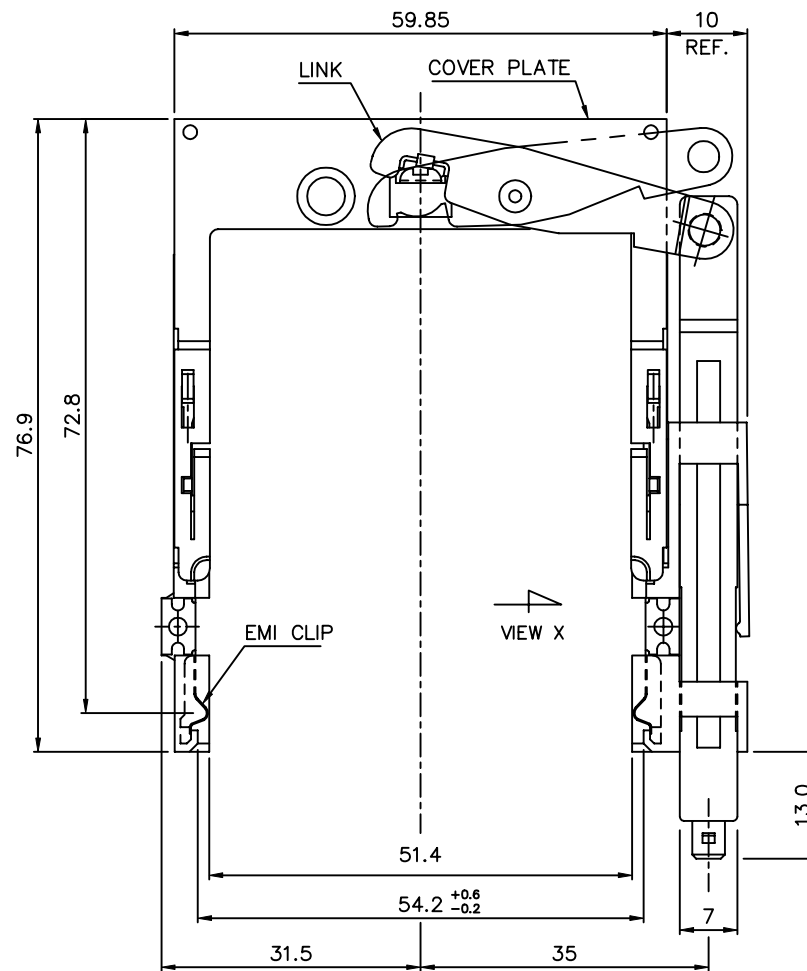
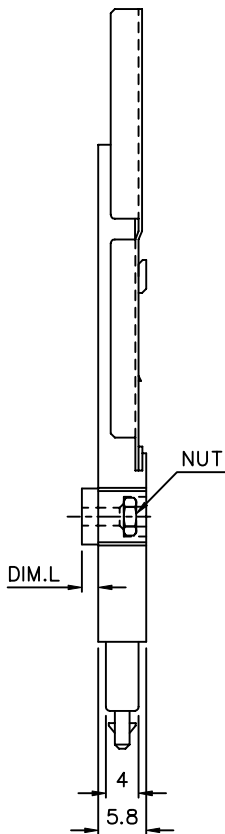

| | | | | | | | |
|------------|----------|--------------------------------------|----------------------|---------------|------------------------|----------------|---|
| mat'l code | | tolerance unless otherwise specified | | CUSTOMER COPY | FCI ELECTRONICS | | |
| rev. | ecn no. | dr | date | linear | ±0.20 | projection | title 68P EJECTOR HEADER TYPE 1/2/3 MECHANISM ASS'Y |
| C | | | | | | | |
| | | | | angles | ± 2° | | product family PCMCIA |
| | | | | | | | |
| | | dr | WENDY CHEN 08/02/95 | unit | mm/inch | size | dwg no. |
| | | enr | JOSEPH HSIA 08/02/95 | scale | 1.5:1 | A3 | 94307 |
| | | chr | JOSEPH HSIA 08/02/95 | | | | sheet 3 OF |
| | | appd | JENN TSAO 08/02/95 | | | | |
| sheet | revision | | | | | | |
| index | sheet | | | | | | |

Tous droits strictement reserves. Reproduction ou communication a des tiers int sous quelque forme que ce soit sans autorisation écrite du propriétaire. Property of c BERG ELECTRONICS. Droits de reproduction BERG ELECTRONICS by

All rights strictly reserved. Reproduction or issue to third parties in any form without the written authority from the proprietor. Property of c BERG ELECTRONICS. Copyright BERG ELECTRONICS by

Tous droits strictement réservés. Reproduction ou communication, en tout ou en partie, sans autorisation écrite du propriétaire. Property of © BERG ELECTRONICS. Droits de reproduction BERG ELECTRONICS by

All rights strictly reserved. Reproduction or issue to third parties in any form without the written authority from the proprietor. Property of © BERG ELECTRONICS. Copyright BERG ELECTRONICS by

| | |
|-------------|--------|
| PRODUCT NO. | DIM. L |
| 94307-10GA | 0.0 |
| 94307-12GA | 2.0 |
| 94307-15GA | 5.0 |

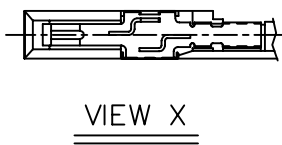

VIEW X

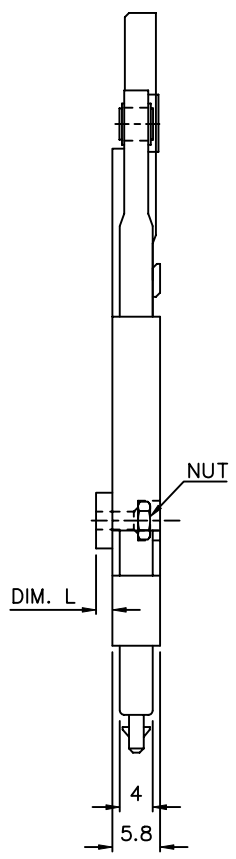

- NOTES:
 1. EJECT PLATE MOVE ALONG INSIDE WALL OF COVER PLATE SMOOTHLY AFTER ASSEMBLING WITH HDR ASS'Y.

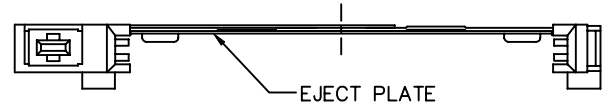
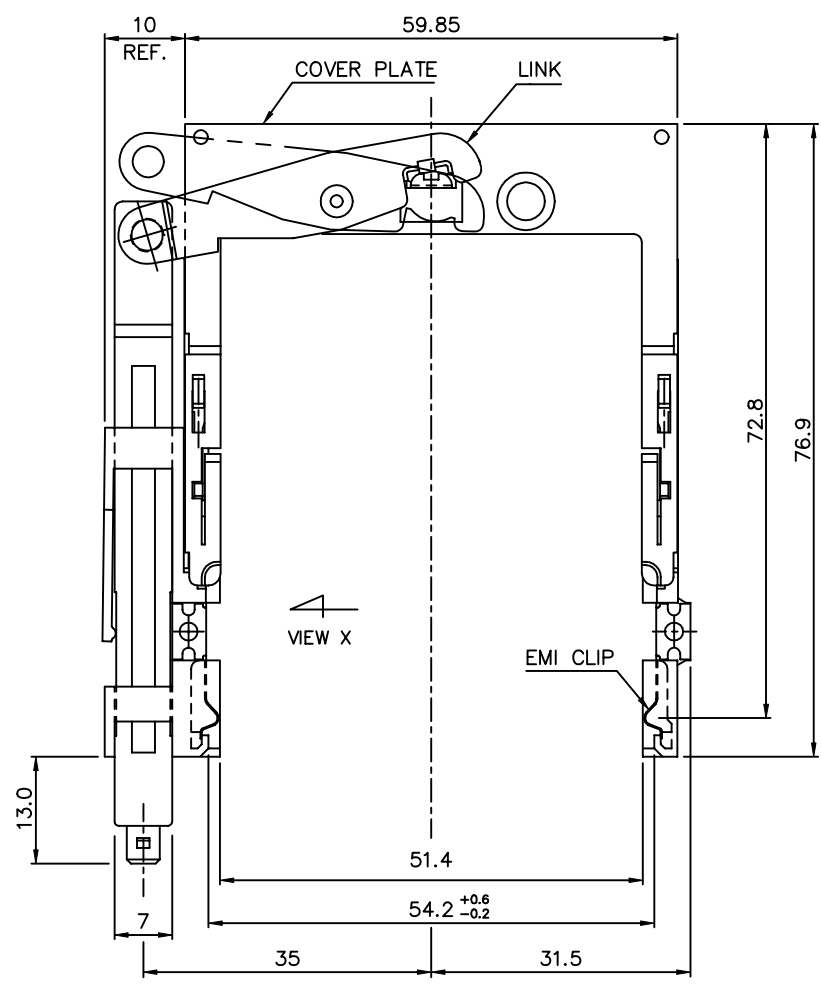

| | | | | | | |
|------------|----------|--------------------------------------|----------------------|----------------|------------------------|-------------------------|
| mat'l code | | tolerance unless otherwise specified | | CUSTOMER COPY | FCI ELECTRONICS | |
| rev. | ecn no. | dr | date | linear | ±0.20 | projection |
| C | | | | angles | ± 2° | title |
| | | dr | WENDY CHEN 08/02/95 | unit | mm/inch | 68P EJECTOR HEADER TYPE |
| | | enr | JOSEPH HSIA 08/02/95 | scale | 1.5:1 | 1/2/3 MECHANISM ASS'Y |
| | | chr | JOSEPH HSIA 08/02/95 | product family | PCMCIA | code |
| | | appd | JENN TSAO 08/02/95 | size | A3 | 94307 |
| sheet | revision | | | scale | sheet 4 OF | |
| index | sheet | | | | | |