

### General information

Part number	S22LOC-P04LPN0-420S
Termination	solder
Size	2
Locking principle	push
Coding	0_key
Cable Diameter	cable_mini_42
Cable outlet	bend_relief

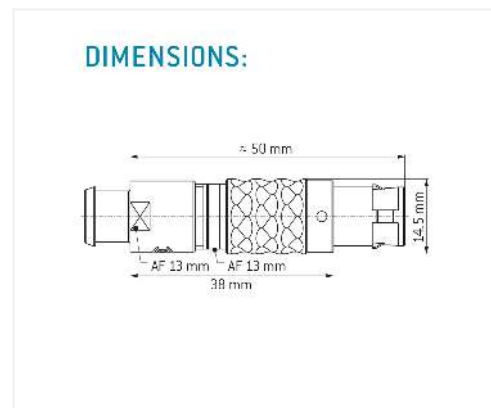
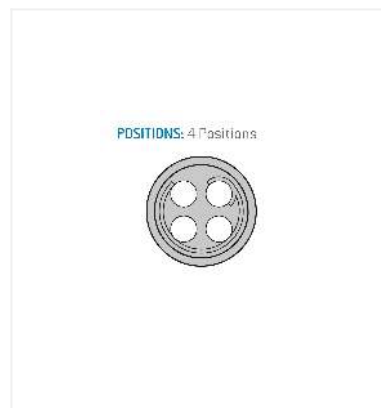

### Contact insert description

Number of contacts	4
Contact type	sockets
Contact diameter	13mm
Insulator material	peek
Wire cross section	18_awg
Termination	solder
Termination diameter	14mm
Data transmission	ethernet_100

reverse\_gender\_on\_request

### Technical information

Max. creepage and air clearance distance	15_mm	13_mm
Nominal current single contact	15_a	iec_60512_5_2
Nominal current insert	15 A	vde_0298_4
Test voltage	18_kv_ac	sae_13441

safety\_text

## Mechanical and environmental data

Degree of protection*	ip50
Operating temperature	40_120_c
Mating cycles	5000

mated\_unmated

## Material and surface treatments

Housing	m_chrome
Contact	cu_alloy_gold

data\_text

safety\_text\_2  
data\_text  
ul\_text  
illustrative\_text