

- NOTES:
1. MATERIAL:  
HSG: LCP, GLASS-FILLED, UL94V-0, COLOR:BLACK  
PIN: 0.50mm SQ, COPPER ALLOY
  2. PLATING:  
(1) 2.540µm TIN OVERALL PLATING OVER NICKEL OVERALL  
(2) 5.080µm TIN OVERALL PLATING OVER NICKEL OVERALL
  3. PACKAGING TYPE: SEE TABLE
  4. PACKAGING SPECIFICATION:  
TRAY: PK-89990-544  
TAPE & REEL: PK-89990-484
  5. PRODUCT SPEC PS-87761-100 APPLIES
  6. IRREGULAR CIRCUIT CUTOFF WITHIN BREAKAWAY SECTION IS PERMISSIBLE. MEASUREMENT AT BOTH ENDS, FROM CUT END TO THE CENTRELINE OF THE HOUSING CORE HOLE OF THE FIRST PIN REMAINS AT 1.00±0.20MM. CUTTING AND CHIPPING OF THE MAIN BODY IS NOT ACCEPTABLE.
  7. THE ABOVE CKT 4 IS FOR ILLUSTRATION PURPOSE ONLY
  8. COPLANARITY IS TO BE MEASURED BY RESTING THE SOLDER TAIL ON A GAUGE SURFACE
  9. KAPTON TAPE LOCATION IS CENTERED ALONG THE PART AS SHOWN.
  10. RECOMMENDED PCB BOARD THICKNESS: 1.60±0.10mm

8	CKT SIZE	
0.10 Z	02-10	
0.15 Z	12-20	

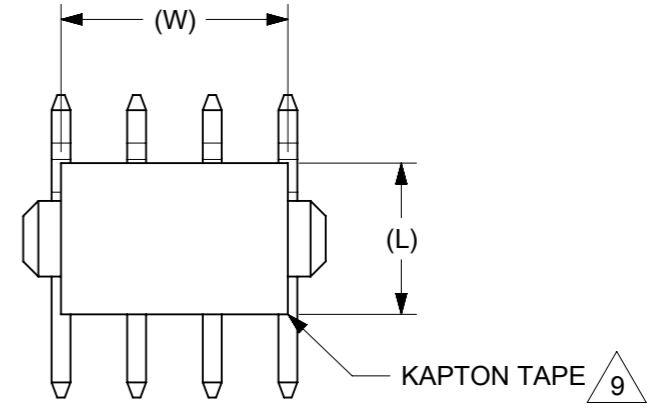
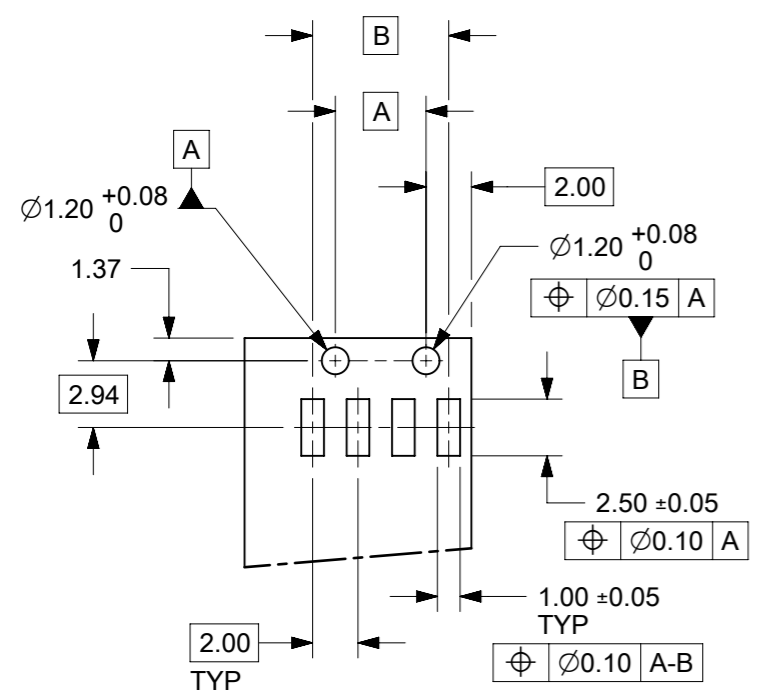
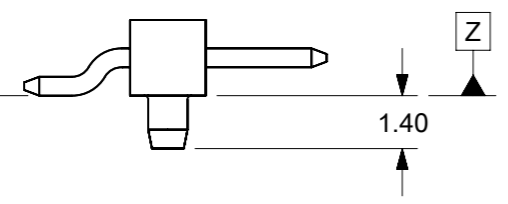

RECOMMENDED PCB LAYOUT

THIS DRAWING CONTAINS INFORMATION THAT IS PROPRIETARY TO MOLEX ELECTRONIC TECHNOLOGIES, LLC AND SHOULD NOT BE USED WITHOUT WRITTEN PERMISSION		CURRENT REV DESC: BRIGHT TIN PHASE OUT			
DIMENSION UNITS	SCALE				
mm	NTS			CUSTOMER	
GENERAL TOLERANCES (UNLESS SPECIFIED)				CUSTOMER	
ANGULAR TOL ± 3.0°				CUSTOMER	
4 PLACES ±				CUSTOMER	
3 PLACES ±				CUSTOMER	
2 PLACES ± 0.2				CUSTOMER	
1 PLACE ±				CUSTOMER	
0 PLACES ±				CUSTOMER	
DRAFT WHERE APPLICABLE MUST REMAIN WITHIN DIMENSIONS				CUSTOMER	
THIRD ANGLE PROJECTION		DRAWING		SHEET NUMBER	
		A3-SIZE		1 OF 3	
SERIES		MATERIAL NUMBER		CUSTOMER	
87858		SEE TABLE		GENERAL MARKET	
DOCUMENT NUMBER		DOC TYPE		DOC PART	
SD-87858-001		PSD		001	
REVISION		REVISION		REVISION	
C6		C6		C6	

DOCUMENT STATUS	P1	RELEASE DATE	2021/10/11	11:53:24
-----------------	----	--------------	------------	----------

CKT SIZE	DIMENSION		
	A	B	C
02	4.00	2.00	-
04	8.00	6.00	4.00
06	12.00	10.00	8.00
08	16.00	14.00	12.00
10	20.00	18.00	16.00
12	24.00	22.00	20.00
14	28.00	26.00	24.00
16	32.00	30.00	28.00
18	36.00	34.00	32.00
20	40.00	38.00	36.00

PART NO. IN TAPE & REEL PACKAGING	PART NO. IN TRAY PACKAGING	CKT SIZE	PEG	PLATE OPT.	VOID POSITION	KAPTON TAPE	DIMENSION				PACKAGING TYPE	
							F	MATING END	SOLDER TAIL	KAPTON TAPE		
								M	P	W		L
-	87858-0002	2	Y	1	---	N	8.00	3.20	2.80	-	-	-
87858-0250	-	2	N	1	---	Y	8.00	3.20	2.80	4.00	3.00	T1
87858-0003	87858-0001	2	Y	1	---	N	10.80	6.00	2.80	-	-	T2
87858-0005	87858-0006	2	N	1	---	N	10.80	6.00	2.80	-	-	T2
-	87858-0004	4	Y	1	---	N	8.00	3.20	2.80	-	-	-
87858-0450	-	4	N	1	---	Y	8.00	3.20	2.80	4.00	4.00	T1
87858-0460	-	4	N	1	---	Y	8.97	4.17	2.80	4.00	4.00	T1
87858-0461	-	4	N	1	---	Y	8.97	4.17	2.80	4.00	4.00	T1

Ⓒ6

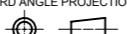
THIS DRAWING CONTAINS INFORMATION THAT IS PROPRIETARY TO MOLEX ELECTRONIC TECHNOLOGIES, LLC AND SHOULD NOT BE USED WITHOUT WRITTEN PERMISSION												
DIMENSION UNITS	SCALE	CURRENT REV DESC: BRIGHT TIN PHASE OUT										
mm	NTS											
GENERAL TOLERANCES (UNLESS SPECIFIED)		EC NO: 679909 DRWN: AKUMAR19 2021/06/25 CHK'D: MRAMAKRISHNA 2021/10/11 APPR: MRAMAKRISHNA 2021/10/11 INITIAL REVISION: DRWN: KSEE 2003/12/14 APPR: PTLIM 2003/12/15						CUSTOM HEADER 2MM SINGLE ROW HDR IN SMT WITH PEG, BREAKAWAY				
ANGULAR TOL	± 3.0 °							PRODUCT CUSTOMER DRAWING				
4 PLACES	±							DOCUMENT NUMBER		DOC TYPE	DOC PART	REVISION
3 PLACES	±							SD-87858-001		PSD	001	C6
2 PLACES	± 0.2											
1 PLACE	±											
0 PLACES	±											
DRAFT WHERE APPLICABLE MUST REMAIN WITHIN DIMENSIONS		THIRD ANGLE PROJECTION	DRAWING	SERIES	MATERIAL NUMBER	CUSTOMER	SHEET NUMBER					
			A3-SIZE	87858	SEE TABLE	GENERAL MARKET	2 OF 3					

DOCUMENT STATUS	P1	RELEASE DATE	2021/10/11 11:53:24
-----------------	----	--------------	---------------------

PACKAGING TYPE	CKT	DIMENSION					PACKABLE QTY
		BoA	Ao	K2	F	W	
T1	2	5.00	8.50	4.40	7.50	16.00	1200
	4	9.00	8.50	4.40	11.50	16.00	1200
T2	2	11.40	5.00	4.20	11.50	24.00	2000

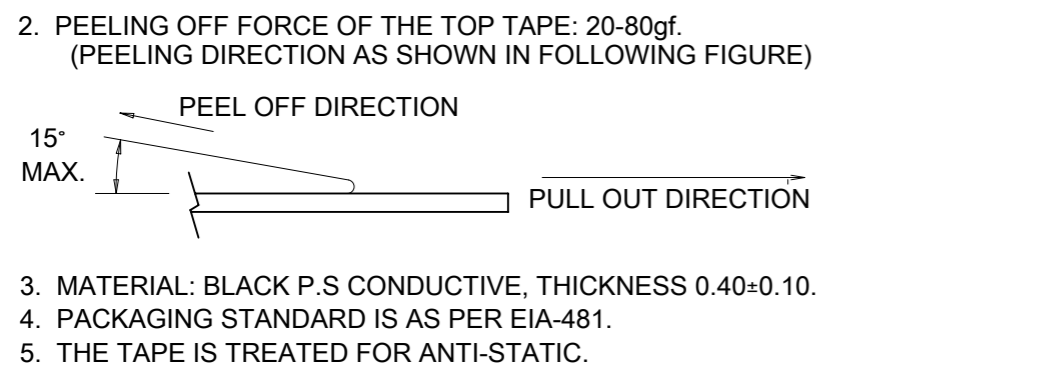
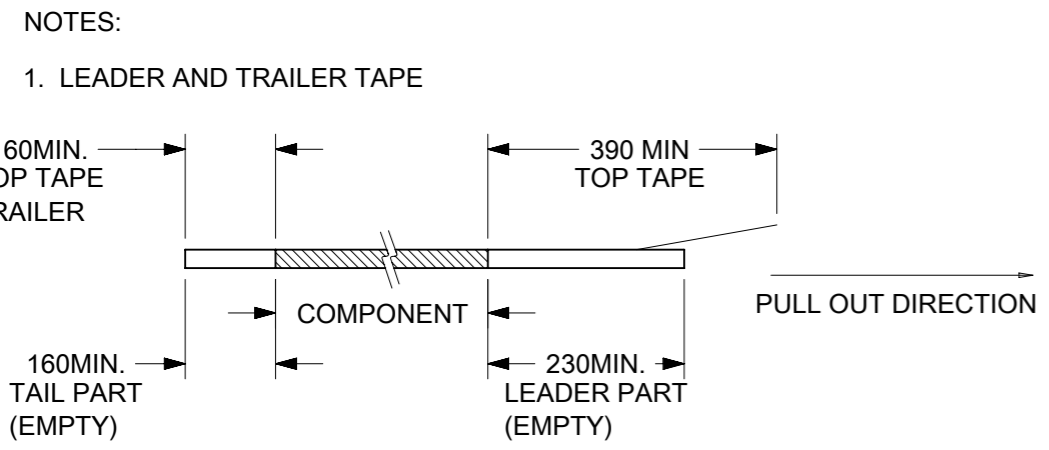
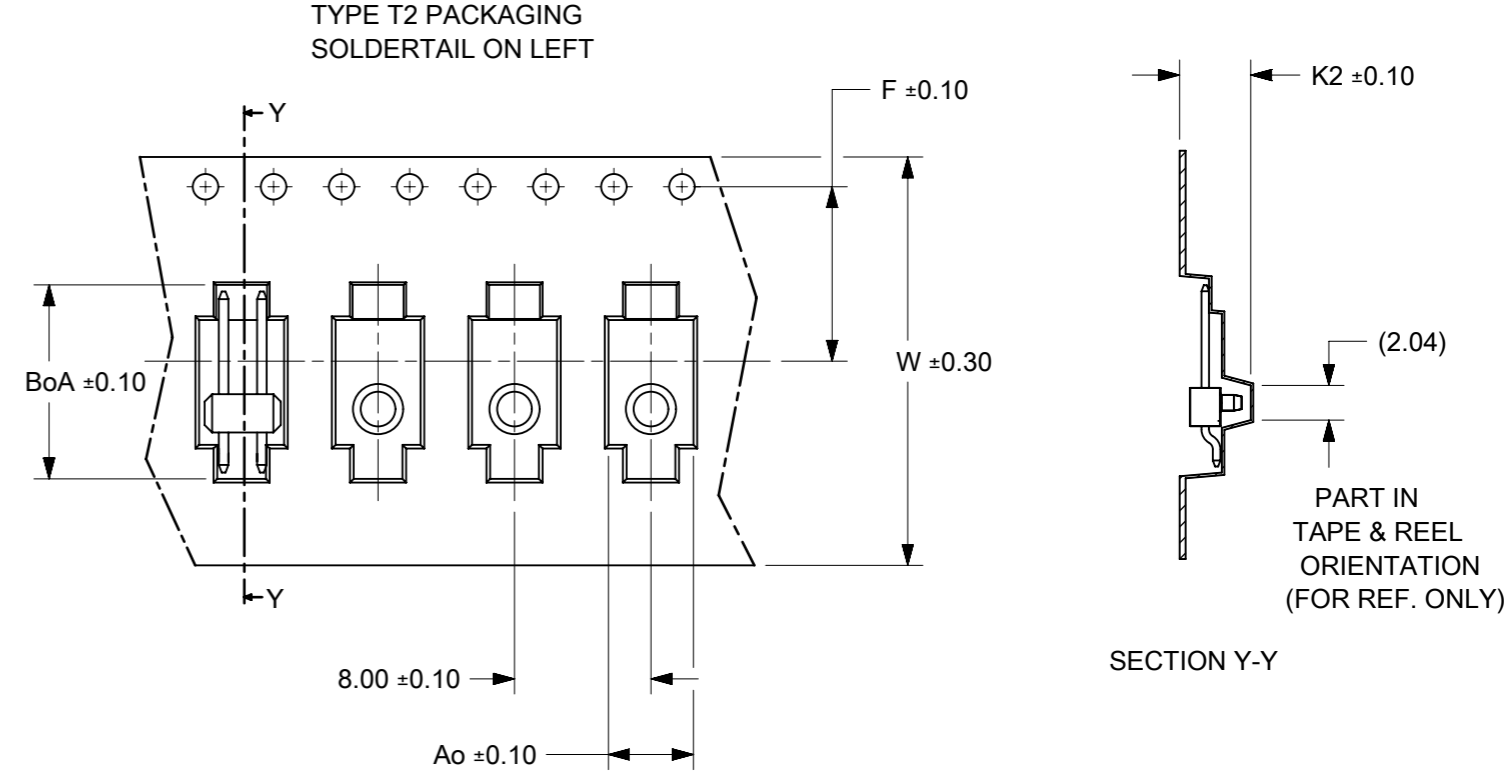
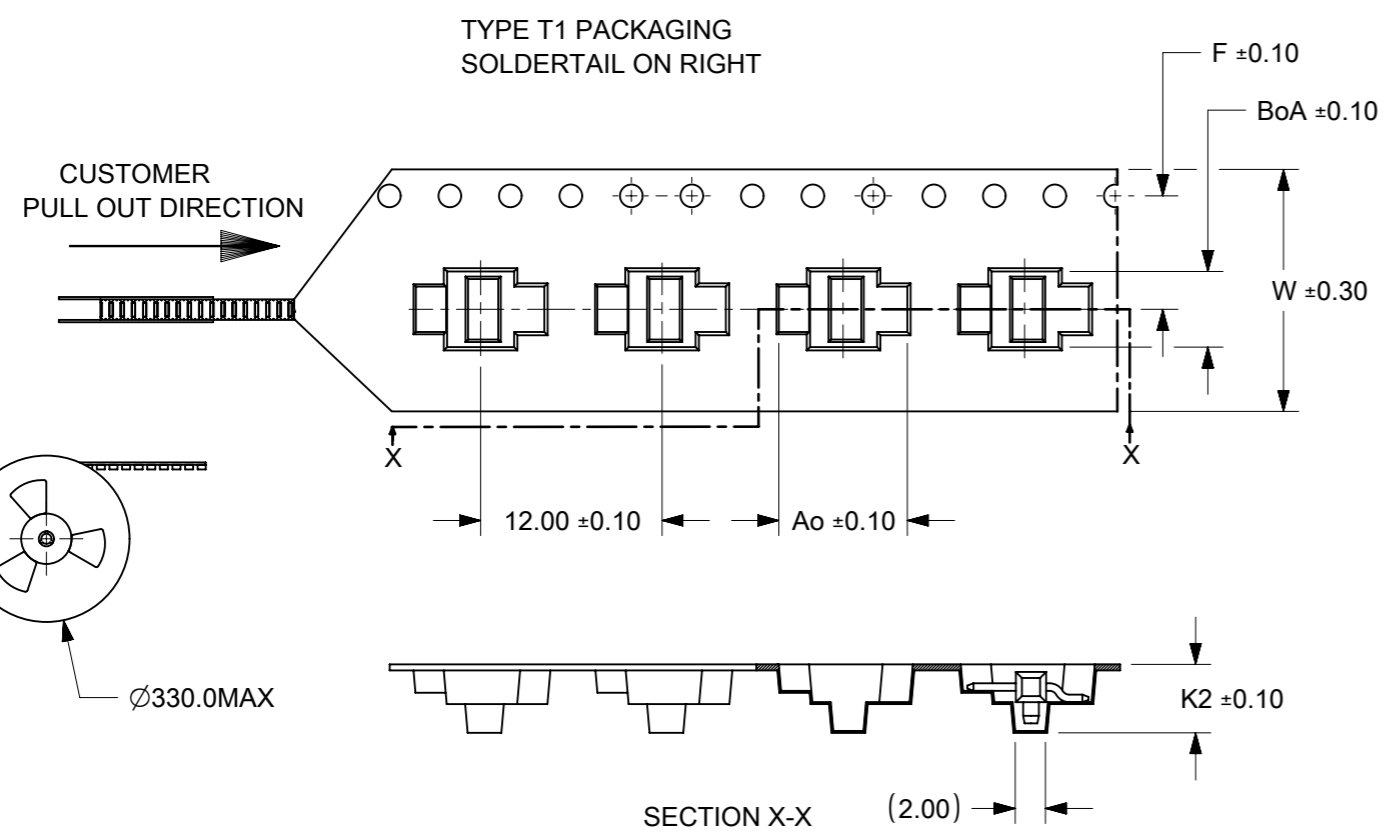

THIS DRAWING CONTAINS INFORMATION THAT IS PROPRIETARY TO MOLEX ELECTRONIC TECHNOLOGIES, LLC AND SHOULD NOT BE USED WITHOUT WRITTEN PERMISSION

DIMENSION UNITS	SCALE	CURRENT REV DESC: BRIGHT TIN PHASE OUT		<b>molex</b>			
mm	NTS						
GENERAL TOLERANCES (UNLESS SPECIFIED)				CUSTOM HEADER 2MM SINGLE ROW HDR IN SMT WITH PEG, BREAKAWAY			
ANGULAR TOL ± 3.0°				PRODUCT CUSTOMER DRAWING			
4 PLACES	±	EC NO: 679909		DOCUMENT NUMBER			
3 PLACES	±	DRWN: AKUMAR19	2021/06/25	SD-87858-001			
2 PLACES	± 0.2	CHK'D: MRAMAKRISHNA	2021/10/11	DOC TYPE	DOC PART	REVISION	
1 PLACE	±	APPR: MRAMAKRISHNA	2021/10/11	PSD	001	C6	
0 PLACES	±	INITIAL REVISION:		SHEET NUMBER			
		DRWN: KSEE	2003/12/14	3 OF 3			
		APPR: PTLIM	2003/12/15				
DRAFT WHERE APPLICABLE MUST REMAIN WITHIN DIMENSIONS		THIRD ANGLE PROJECTION	DRAWING	SERIES	MATERIAL NUMBER	CUSTOMER	
			A3-SIZE	87858	SEE TABLE	GENERAL MARKET	