

LM4952 Boomer™ Audio Power Amplifier Series 3.1W Stereo-SE Audio Power Amplifier with DC Volume Control

Check for Samples: [LM4952](#)

FEATURES

- Pop & Click Circuitry Eliminates Noise During Turn-on and Turn-off Transitions
- Low Current, Active-low Shutdown Mode
- Low Quiescent Current
- Stereo 3.8W Output, $R_L = 4\Omega$
- DC-controlled Volume Control
- Short Circuit Protection

APPLICATIONS

- Flat Panel Monitors
- Flat Panel TV's
- Computer Sound Cards

KEY SPECIFICATIONS

- Quiescent Power Supply Current 18mA (typ)
- P_{OUT} @ $V_{DD} = 12V$, $R_L = 4\Omega$, 10% THD+N 3.8W (typ)
- Shutdown current 55 μ A (typ)

DESCRIPTION

The LM4952 is a dual audio power amplifier primarily designed for demanding applications in flat panel monitors and TV's. It is capable of delivering 3.1 watts per channel to a 4 Ω single-ended load with less than 1% THD+N when powered by a 12V_{DC} power supply.

Eliminating external feedback resistors, an internal, DC-controlled, volume control allows easy and variable gain adjustment.

Boomer audio power amplifiers were designed specifically to provide high quality output power with a minimal amount of external components. The LM4952 does not require bootstrap capacitors or snubber circuits. Therefore, it is ideally suited for display applications requiring high power and minimal size.

The LM4952 features a low-power consumption active-low shutdown mode. Additionally, the LM4952 features an internal thermal shutdown protection mechanism along with short circuit protection.

The LM4952 contains advanced pop & click circuitry that eliminates noises which would otherwise occur during turn-on and turn-off transitions.



Please be aware that an important notice concerning availability, standard warranty, and use in critical applications of Texas Instruments semiconductor products and disclaimers thereto appears at the end of this data sheet.

Boomer is a trademark of Texas Instruments Incorporated.
All other trademarks are the property of their respective owners.

Connection Diagram

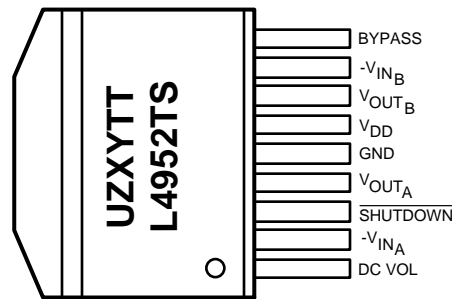

Figure 1. DPAK – Top View
See Package Number KTW
L4952TS = LM4952TS

Typical Application

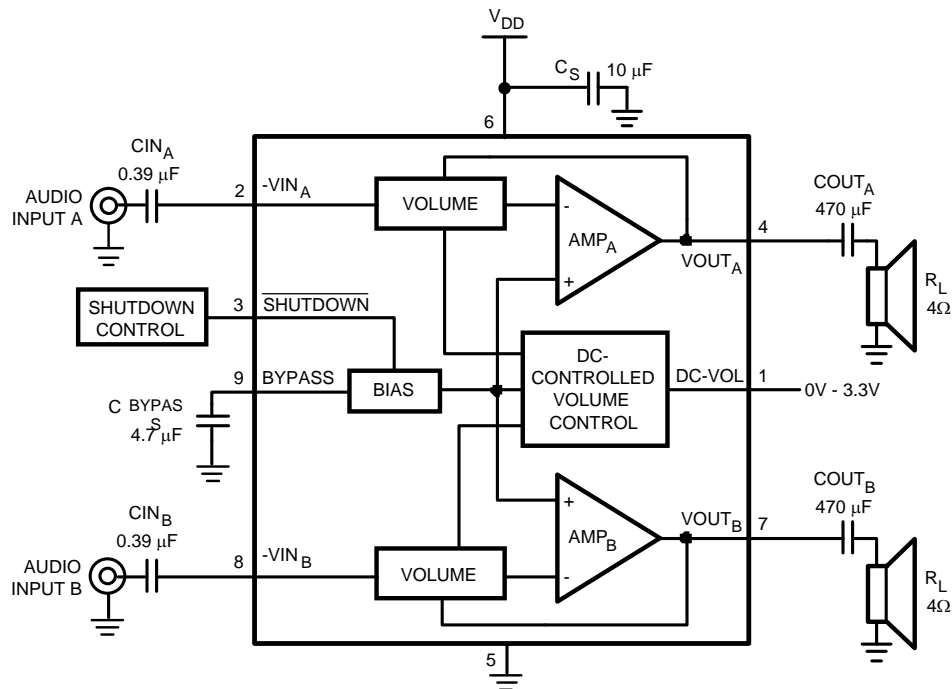

Figure 2. Typical LM4952 SE Audio Amplifier Application Circuit



These devices have limited built-in ESD protection. The leads should be shorted together or the device placed in conductive foam during storage or handling to prevent electrostatic damage to the MOS gates.

Absolute Maximum Ratings⁽¹⁾⁽²⁾⁽³⁾

Supply Voltage (pin 6, referenced to GND, pins 4 and 5)		18.0V
Storage Temperature		-65°C to +150°C
Input Voltage	pins 4, 6, and 7	-0.3V to $V_{DD} + 0.3V$
	pins 1, 2, 3, 8, and 9	-0.3V to 9.5V
Power Dissipation ⁽⁴⁾		Internally limited
ESD Susceptibility ⁽⁵⁾		2000V
ESD Susceptibility ⁽⁶⁾		200V
Junction Temperature		150°C
Thermal Resistance	θ_{JC} (TS)	4°C/W
	θ_{JA} (TS) ⁽⁴⁾	20°C/W

- All voltages are measured with respect to the GND pin, unless otherwise specified.
- Absolute Maximum Ratings* indicate limits beyond which damage to the device may occur. *Operating Ratings* indicate conditions for which the device is functional, but do not specify specific performance limits. *Electrical Characteristics* state DC and AC electrical specifications under particular test conditions which specify specific performance limits. This assumes that the device is within the Operating Ratings. Specifications are not specified for parameters where no limit is given, however, the typical value is a good indication of device performance.
- If Military/Aerospace specified devices are required, please contact the Texas Instruments Sales Office/ Distributors for availability and specifications.
- The maximum power dissipation must be derated at elevated temperatures and is dictated by T_{JMAX} , θ_{JA} , and the ambient temperature, T_A . The maximum allowable power dissipation is $P_{DMAX} = (T_{JMAX} - T_A) / \theta_{JA}$ or the given in Absolute Maximum Ratings, whichever is lower. For the LM4952 typical application (shown in Figure 2) with $V_{DD} = 12V$, $R_L = 4\Omega$ stereo operation the total power dissipation is 3.65W. $\theta_{JA} = 20^\circ\text{C/W}$ for the DDPACK package mounted to 16in² heatsink surface area.
- Human body model, 100pF discharged through a 1.5k Ω resistor.
- Machine Model, 220pF–240pF discharged through all pins.

Operating Ratings

Temperature Range	$T_{MIN} \leq T_A \leq T_{MAX}$	-40°C $\leq T_A \leq$ 85°C
Supply Voltage		9.6V $\leq V_{DD} \leq$ 16V

Electrical Characteristics $V_{DD} = 12V$ ⁽¹⁾⁽²⁾

The following specifications apply for $V_{DD} = 12V$, $A_V = 20\text{dB}$ (nominal), $R_L = 4\Omega$, and $T_A = 25^\circ\text{C}$ unless otherwise noted.

Symbol	Parameter	Conditions	LM4952		Units (Limits)
			Typical ⁽³⁾	Limit ⁽⁴⁾⁽⁵⁾	
I_{DD}	Quiescent Power Supply Current	$V_{IN} = 0V$, $I_O = 0A$, No Load	18	35	mA (max)
I_{SD}	Shutdown Current	$V_{SHUTDOWN} = \text{GND}$ ⁽⁶⁾	55	85	μA (max)
R_{IN}	Amplifier Input Resistance	$V_{DC VOL} = V_{DD}/2$	44		k Ω
		$V_{DC VOL} = \text{GND}$	200		k Ω
V_{IN}	Amplifier Input Signal			$V_{DD}/2$	V_{P-P} (max)
V_{SDIH}	Shutdown Voltage Input High			2.0	V (min)
				$V_{DD}/2$	V (max)
V_{SDIL}	Shutdown Voltage Input Low			0.4	V (max)
T_{WU}	Wake-up Time	$C_B = 4.7\mu\text{F}$	440		ms
TSD	Thermal Shutdown Temperature		170		°C
P_O	Output Power	$f = 1\text{kHz}$, THD+N = 1%	3.1	2.8	W (min)
		THD+N = 10%	3.8		

- All voltages are measured with respect to the GND pin, unless otherwise specified.
- Absolute Maximum Ratings* indicate limits beyond which damage to the device may occur. *Operating Ratings* indicate conditions for which the device is functional, but do not specify specific performance limits. *Electrical Characteristics* state DC and AC electrical specifications under particular test conditions which specify specific performance limits. This assumes that the device is within the Operating Ratings. Specifications are not specified for parameters where no limit is given, however, the typical value is a good indication of device performance.
- Typicals are measured at 25°C and represent the parametric norm.
- Limits are ensured to AOQL (Average Outgoing Quality Level).
- Datasheet min/max specification limits are ensured by design, test, or statistical analysis.
- Shutdown current is measured in a normal room environment. The Shutdown pin should be driven as close as possible to GND for minimum shutdown current.

Electrical Characteristics $V_{DD} = 12V^{(1)(2)}$ (continued)

The following specifications apply for $V_{DD} = 12V$, $A_V = 20dB$ (nominal), $R_L = 4\Omega$, and $T_A = 25^\circ C$ unless otherwise noted.

Symbol	Parameter	Conditions	LM4952		Units (Limits)
			Typical ⁽³⁾	Limit ⁽⁴⁾⁽⁵⁾	
THD+N	Total Harmonic Distortion + Noise	$P_O = 2.0W_{rms}$, $f = 1kHz$	0.08		%
ϵ_{OS}	Output Noise	A-Weighted Filter, $V_{IN} = 0V$, Input Referred	8		μV
X_{TALK}	Channel Separation	$f_{IN} = 1kHz$, $P_O = 1W$, Input Referred $R_L = 8\Omega$ $R_L = 4\Omega$	78 72		dB
PSRR	Power Supply Rejection Ratio	$V_{RIPPLE} = 200mV_{p-p}$, $f = 1kHz$, Input Referred	89	80	dB (min)
I_{OL}	Output Current Limit	$V_{IN} = 0V$, $R_L = 500m\Omega$	5		A

Electrical Characteristics for Volume Control⁽¹⁾⁽²⁾

The following specifications apply for $V_{DD} = 12V$, $A_V = 20dB$ (nominal), and $T_A = 25^\circ C$ unless otherwise noted.

Symbol	Parameter	Conditions	LM4952		Units (Limits)
			Typical ⁽³⁾	Limit ⁽⁴⁾	
VOL_{max}	Gain	$V_{DC-VOL} = \text{Full scale}$, No Load	20		dB
VOL_{min}	Gain	$V_{DC-VOL} = +1LSB$, No Load	-46		dB
A_M	Mute Attenuation	$V_{DC-VOL} = 0V$, No Load	75	63	dB (min)

- (1) All voltages are measured with respect to the GND pin, unless otherwise specified.
- (2) *Absolute Maximum Ratings* indicate limits beyond which damage to the device may occur. *Operating Ratings* indicate conditions for which the device is functional, but do not specify specific performance limits. *Electrical Characteristics* state DC and AC electrical specifications under particular test conditions which specify specific performance limits. This assumes that the device is within the Operating Ratings. Specifications are not specified for parameters where no limit is given, however, the typical value is a good indication of device performance.
- (3) Typicals are measured at $25^\circ C$ and represent the parametric norm.
- (4) Limits are ensured to AOQL (Average Outgoing Quality Level).

External Components Description

Refer to [Figure 2](#).

Components	Functional Description
1. C_{IN}	This is the input coupling capacitor. It blocks DC voltage at the amplifier's inverting input. C_{IN} and R_{IN} create a highpass filter. The filter's cutoff frequency is $f_C = 1/(2\pi R_{IN} C_{IN})$. Refer to SELECTING EXTERNAL COMPONENTS , for an explanation of determining C_{IN} 's value.
2. C_S	The supply bypass capacitor. Refer to POWER SUPPLY BYPASSING for information about properly placing, and selecting the value of, this capacitor.
3. C_{BYPASS}	This capacitor filters the half-supply voltage present on the BYPASS pin. Refer to SELECTING EXTERNAL COMPONENTS for information about properly placing, and selecting the value of, this capacitor.

Typical Performance Characteristics

$A_V = 20\text{dB}$ and $T_A = 25^\circ\text{C}$, unless otherwise noted.

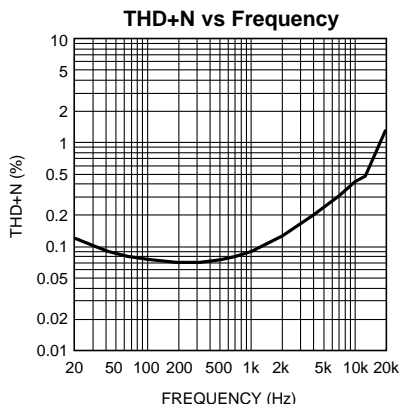

$V_{DD} = 12\text{V}$, $R_L = 4\Omega$,
 $P_{OUT} = 2\text{W}$, $C_{IN} = 1.0\mu\text{F}$

Figure 3.

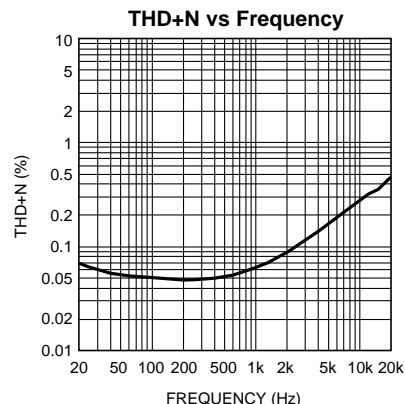

$V_{DD} = 12\text{V}$, $R_L = 8\Omega$,
 $P_{OUT} = 1\text{W}$, $C_{IN} = 1.0\mu\text{F}$

Figure 4.

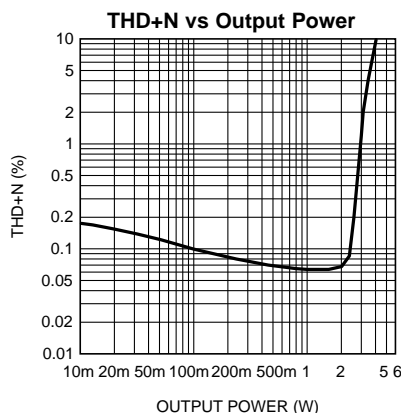

$V_{DD} = 12\text{V}$, $R_L = 4\Omega$,
 $f_{IN} = 1\text{kHz}$

Figure 5.

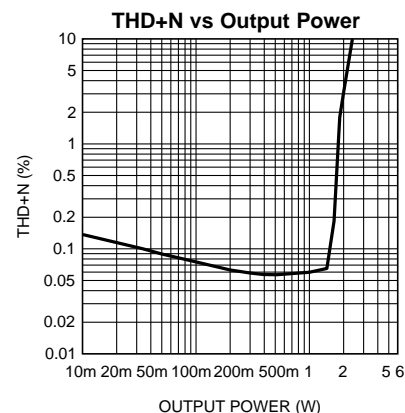

$V_{DD} = 12\text{V}$, $R_L = 8\Omega$,
 $f_{IN} = 1\text{kHz}$

Figure 6.

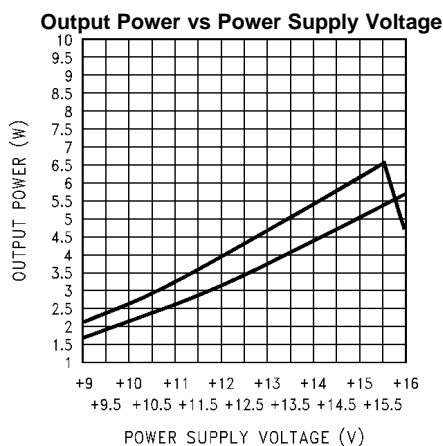

$R_L = 4\Omega$, $f_{IN} = 1\text{kHz}$
both channels driven and loaded (average shown),
at (from top to bottom at 12V):
THD+N = 10%, THD+N = 1%

Figure 7.

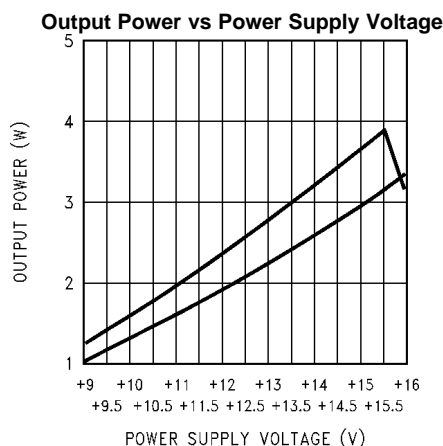

$R_L = 8\Omega$, $f_{IN} = 1\text{kHz}$
both channels driven and loaded (average shown),
at (from top to bottom at 12V):
THD+N = 10%, THD+N = 1%

Figure 8.

Typical Performance Characteristics (continued)

$A_V = 20\text{dB}$ and $T_A = 25^\circ\text{C}$, unless otherwise noted.

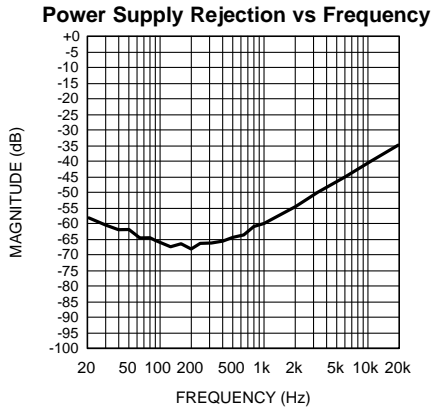

$V_{DD} = 12\text{V}$, $R_L = 4\Omega$,
 $V_{RIPPLE} = 200\text{mV}_{p-p}$

Figure 9.

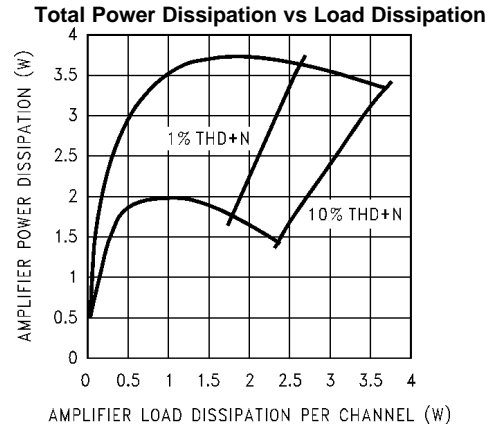

$V_{DD} = 12\text{V}$, $f_{IN} = 1\text{kHz}$,
 at (from top to bottom at 1W):
 $R_L = 4\Omega$, $R_L = 8\Omega$

Figure 10.

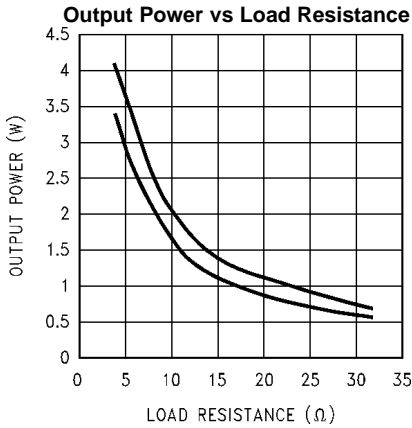

$V_{DD} = 12\text{V}$, $f_{IN} = 1\text{kHz}$,
 at (from top to bottom at 15Ω):
 $\text{THD+N} = 10\%$, $\text{THD+N} = 1\%$

Figure 11.

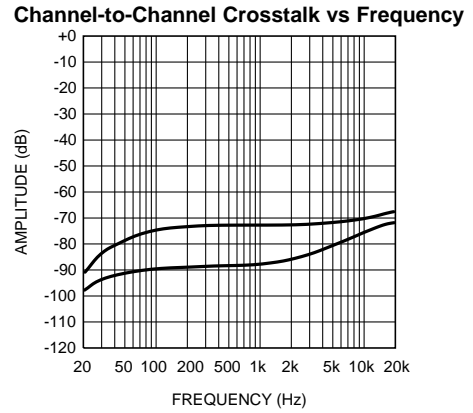

$V_{DD} = 12\text{V}$, $R_L = 4\Omega$, $P_{OUT} = 1\text{W}$, Input Referred
 at (from top to bottom at 1kHz): V_{INB} driven,
 V_{OUTA} measured, V_{INA} driven, V_{OUTB} measured

Figure 12.

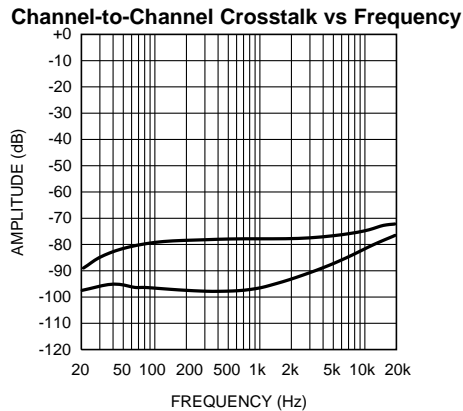

$V_{DD} = 12\text{V}$, $R_L = 8\Omega$, $P_{OUT} = 1\text{W}$, Input Referred
 at (from top to bottom at 1kHz): V_{INB} driven,
 V_{OUTA} measured, V_{INA} driven, V_{OUTB} measured

Figure 13.

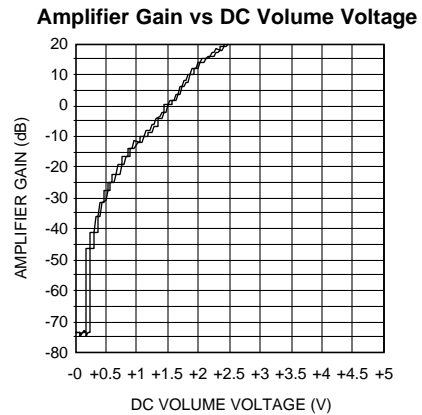

$V_{DD} = 12\text{V}$, $R_L = 8\Omega$, at (from top to bottom at 1.5V):
 Decreasing DC Volume Voltage, Increasing DC Volume Voltage

Figure 14.

Typical Performance Characteristics (continued)

$A_V = 20\text{dB}$ and $T_A = 25^\circ\text{C}$, unless otherwise noted.

Amplifier Gain vs Part-to-Part DC Volume Voltage Variation (Five parts)

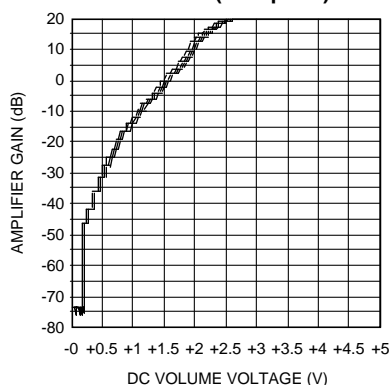

Figure 15.

$V_{DD} = 12\text{V}$, $R_L = 8\Omega$,

THD+N vs Frequency

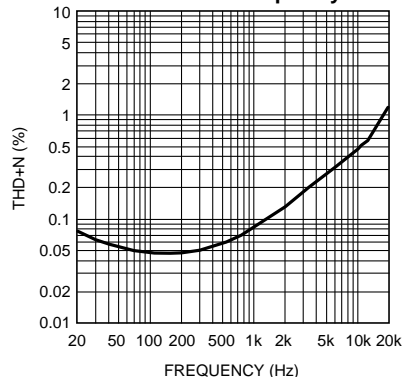

Figure 16.

$V_{DD} = 9.6\text{V}$, $R_L = 4\Omega$,
 $P_{OUT} = 1.1\text{W}$, $C_{IN} = 1.0\mu\text{F}$

THD+N vs Frequency

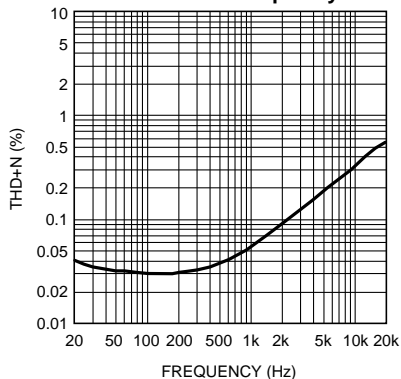

Figure 17.

$V_{DD} = 9.6\text{V}$, $R_L = 8\Omega$,
 $P_{OUT} = 850\text{mW}$, $C_{IN} = 1.0\mu\text{F}$

THD+N vs Output Power

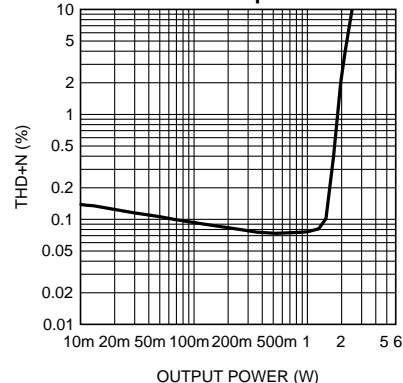

Figure 18.

$V_{DD} = 9.6\text{V}$, $R_L = 4\Omega$,
 $f_{IN} = 1\text{kHz}$

THD+N vs Output Power

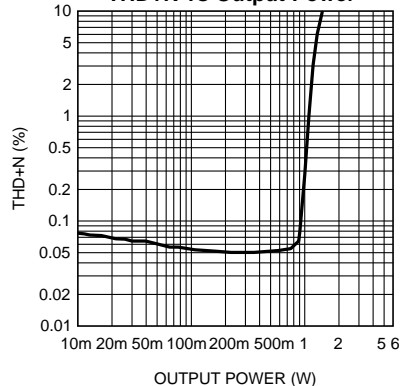

Figure 19.

$V_{DD} = 9.6\text{V}$, $R_L = 8\Omega$,
 $f_{IN} = 1\text{kHz}$

Total Power Dissipation vs Load Dissipation

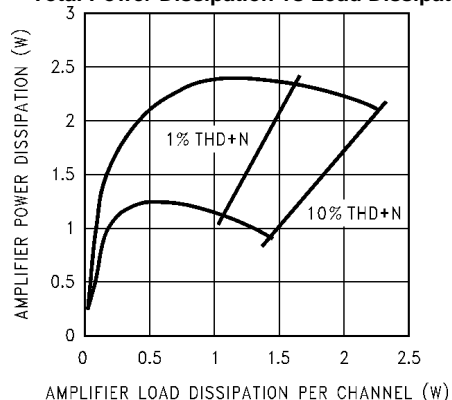
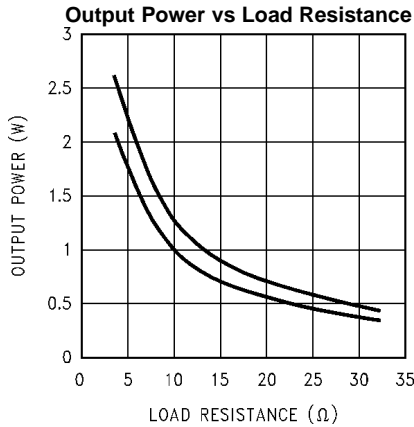

Figure 20.

$V_{DD} = 9.6\text{V}$, $f_{IN} = 1\text{kHz}$
at (from top to bottom at 1W):
 $R_L = 4\Omega$, $R_L = 8\Omega$

Typical Performance Characteristics (continued)

$A_V = 20\text{dB}$ and $T_A = 25^\circ\text{C}$, unless otherwise noted.



$V_{DD} = 9.6\text{V}$, $f_{IN} = 1\text{kHz}$,
at (from top to bottom at 15Ω):
 $\text{THD+N} = 10\%$, $\text{THD+N} = 1\%$

Figure 21.

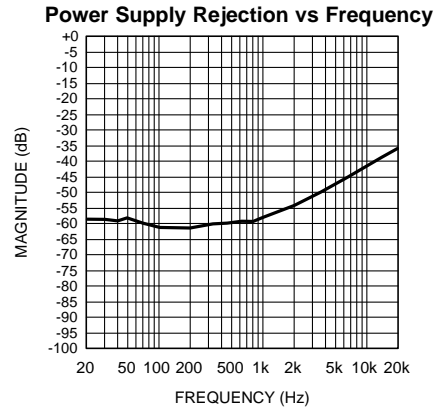

$V_{DD} = 9.6\text{V}$, $R_L = 4\Omega$,
 $V_{RIPPLE} = 200\text{mV}_{P-P}$

Figure 22.

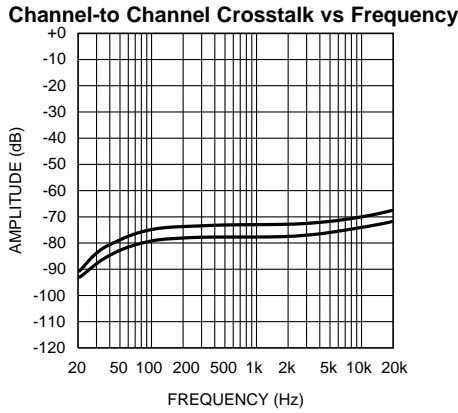

$V_{DD} = 9.6\text{V}$, $R_L = 4\Omega$, $P_{OUT} = 1\text{W}$, Input Referred
at (from top to bottom at 1kHz): V_{INB} driven, V_{OUTA} measured; V_{INA}
driven, V_{OUTB} measured

Figure 23.

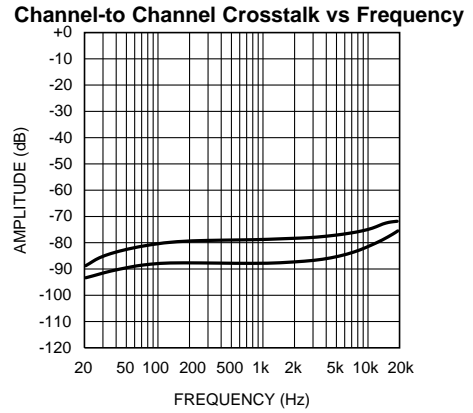

$V_{DD} = 9.6\text{V}$, $R_L = 8\Omega$, $P_{OUT} = 1\text{W}$, Input Referred
at (from top to bottom at 1kHz): V_{INB} driven, V_{OUTA} measured; V_{INA}
driven, V_{OUTB} measured

Figure 24.

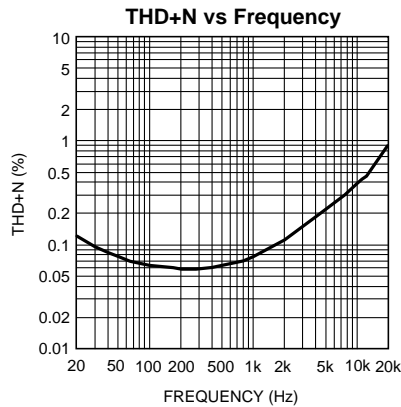

$V_{DD} = 14\text{V}$, $R_L = 4\Omega$,
 $P_{OUT} = 2\text{W}$, $C_{IN} = 1.0\mu\text{F}$

Figure 25.

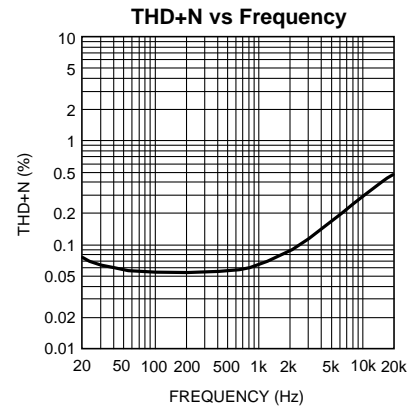

$V_{DD} = 14\text{V}$, $R_L = 8\Omega$,
 $P_{OUT} = 1\text{W}$, $C_{IN} = 1.0\mu\text{F}$

Figure 26.

Typical Performance Characteristics (continued)

$A_V = 20\text{dB}$ and $T_A = 25^\circ\text{C}$, unless otherwise noted.

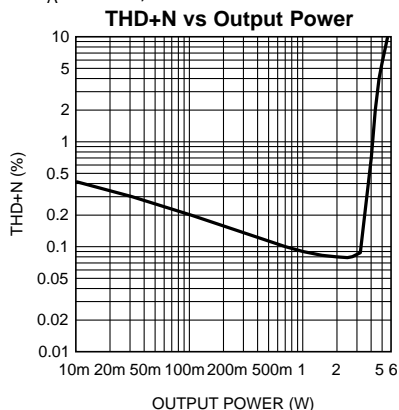

$V_{DD} = 14\text{V}$, $R_L = 4\Omega$,
 $f_{IN} = 1\text{kHz}$

Figure 27.

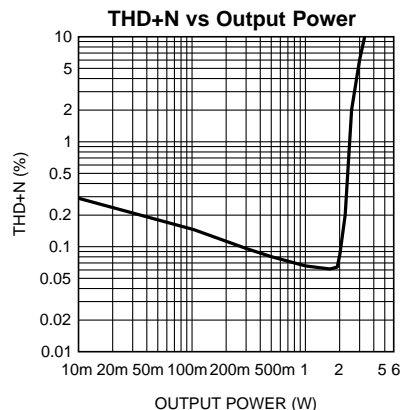

$V_{DD} = 14\text{V}$, $R_L = 8\Omega$,
 $f_{IN} = 1\text{kHz}$

Figure 28.

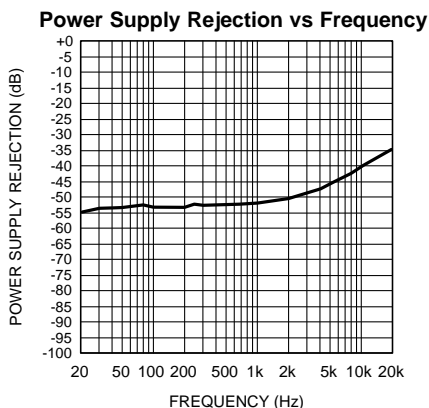

$V_{DD} = 14\text{V}$, $R_L = 4\Omega$,
 $V_{RIPPLE} = 200\text{mV}_{P-P}$

Figure 29.

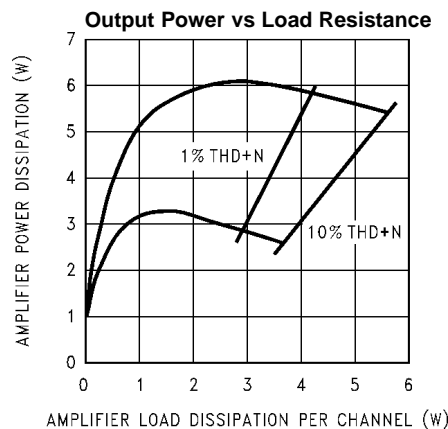

$V_{DD} = 15\text{V}$, $f_{IN} = 1\text{kHz}$,
at (from top to bottom at 2W):
 $R_L = 4\Omega$, $R_L = 8\Omega$

Figure 30.

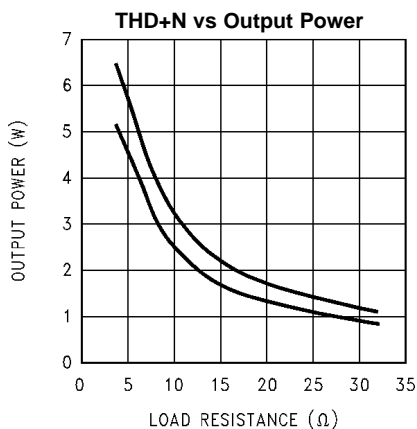

$V_{DD} = 15\text{V}$, at (from top to bottom at 15Ω):
 $\text{THD+N} = 10\%$, $\text{THD+N} = 1\%$, $f_{IN} = 1\text{kHz}$

Figure 31.

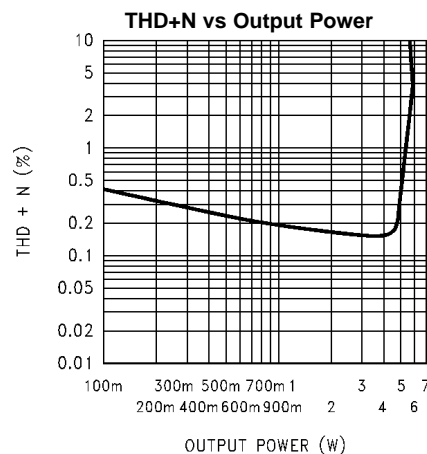

$V_{DD} = 16\text{V}$, $R_L = 4\Omega$,
 $f_{IN} = 1\text{kHz}$

Figure 32.

Typical Performance Characteristics (continued)

$A_V = 20\text{dB}$ and $T_A = 25^\circ\text{C}$, unless otherwise noted.

Channel-to-Channel Crosstalk vs Frequency

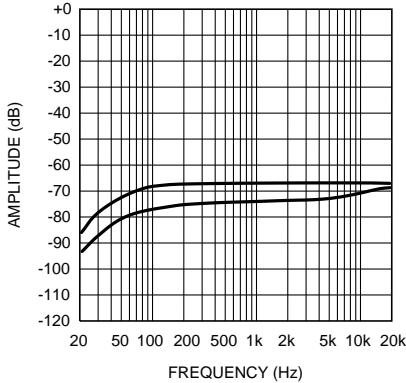

$V_{DD} = 16\text{V}$, $R_L = 4\Omega$, $P_{OUT} = 1\text{W}$, Input Referred
at (from top to bottom at 1kHz): V_{INB} driven, V_{OUTA} measured; V_{INA} driven, V_{OUTB} measured

Figure 33.

Channel-to-Channel Crosstalk vs Frequency

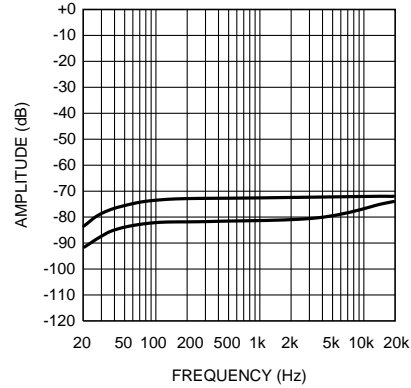

$V_{DD} = 16\text{V}$, $R_L = 8\Omega$, $P_{OUT} = 1\text{W}$, Input Referred
at (from top to bottom at 1kHz): V_{INB} driven, V_{OUTA} measured; V_{INA} driven, V_{OUTB} measured

Figure 34.

Power Supply Current vs Power Supply Voltage

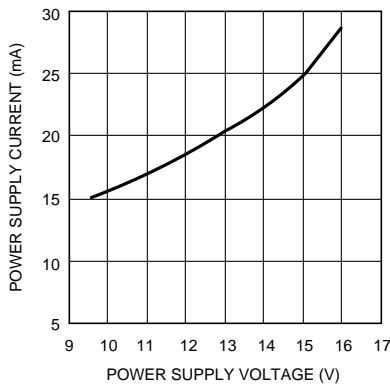

$R_L = 4\Omega$,
 $V_{IN} = 0\text{V}$, $R_{SOURCE} = 50\Omega$

Figure 35.

Clipping Voltage vs Power Supply Voltage

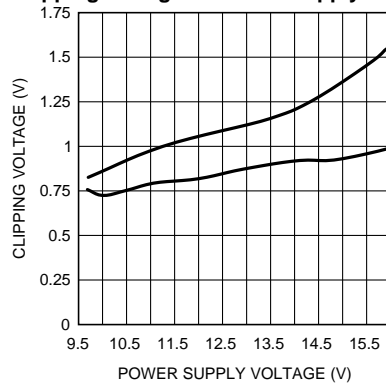

$R_L = 4\Omega$, $f_{IN} = 1\text{kHz}$
at (from top to bottom at 12.5V):
positive signal swing, negative signal swing

Figure 36.

Clipping Voltage vs Power Supply Voltage

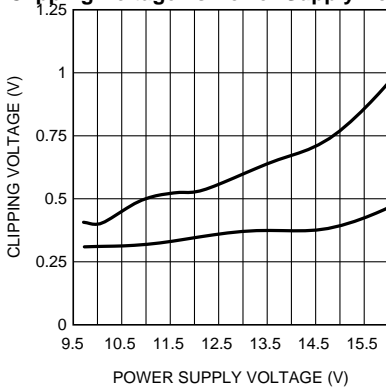

$R_L = 8\Omega$, $f_{IN} = 1\text{kHz}$
at (from to bottom at 12.5V):
positive signal swing, negative signal swing

Figure 37.

Power Dissipation vs Ambient Temperature

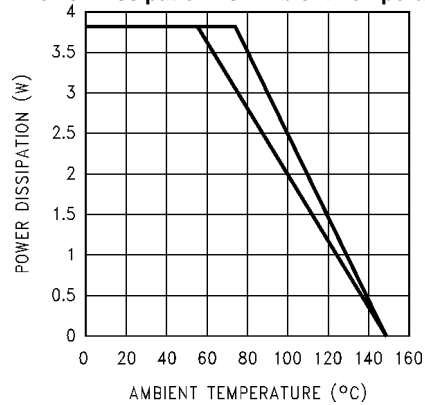

$V_{DD} = 12\text{V}$, $R_L = 4\Omega$ (SE), $f_{IN} = 1\text{kHz}$,
(from to bottom at 80°C): 16in^2 copper plane heatsink area, 8in^2 copper plane heatsink area

Figure 38.

Typical Performance Characteristics (continued)

$A_V = 20\text{dB}$ and $T_A = 25^\circ\text{C}$, unless otherwise noted.

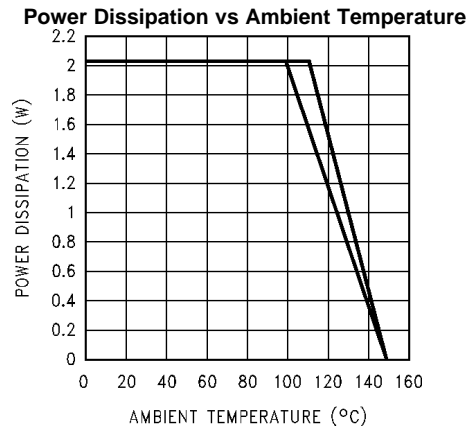

$V_{DD} = 12\text{V}$, $R_L = 8\Omega$, $f_{IN} = 1\text{kHz}$,
 (from top to bottom at 120°C): 16in^2 copper plane heatsink area, 8in^2 copper plane heatsink area
Figure 39.

APPLICATION INFORMATION

HIGH VOLTAGE BOOMER WITH INCREASED OUTPUT POWER

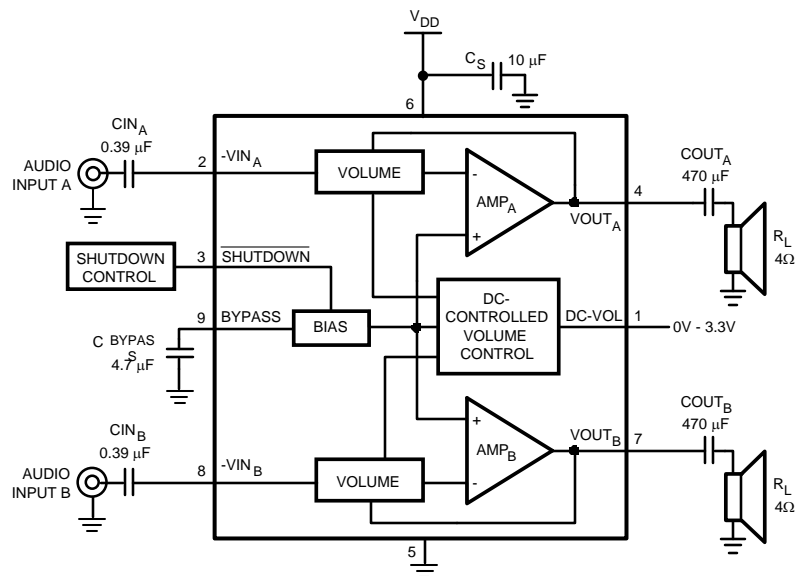

Figure 40. Typical LM4952 SE Application Circuit

Unlike previous 5V Boomer amplifiers, the LM4952 is designed to operate over a power supply voltages range of 9.6V to 16V. Operating on a 12V power supply, the LM4952 will deliver 3.8W into a 4Ω SE load with no more than 10% THD+N.

POWER DISSIPATION

Power dissipation is a major concern when designing a successful single-ended or bridged amplifier. Equation 1 states the maximum power dissipation point for a single-ended amplifier operating at a given supply voltage and driving a specified output load.

$$P_{\text{DMAX-SE}} = (V_{\text{DD}})^2 / (2\pi^2 R_L): \text{ Single Ended} \quad (1)$$

The LM4952's dissipation is twice the value given by Equation 1 when driving two SE loads. For a 12V supply and two 4Ω SE loads, the LM4952's dissipation is 1.82W.

The maximum power dissipation point given by Equation 1 must not exceed the power dissipation given by Equation 2:

$$P_{\text{DMAX}}' = (T_{\text{JMAX}} - T_{\text{A}}) / \theta_{\text{JA}} \quad (2)$$

The LM4952's $T_{\text{JMAX}} = 150^\circ\text{C}$. In the TS package, the LM4952's θ_{JA} is 20°C/W when the metal tab is soldered to a copper plane of at least 16in^2 . This plane can be split between the top and bottom layers of a two-sided PCB. Connect the two layers together under the tab with a 5×5 array of vias. At any given ambient temperature T_{A} , use Equation 2 to find the maximum internal power dissipation supported by the IC packaging. Rearranging Equation 2 and substituting P_{DMAX} for P_{DMAX}' results in Equation 3. This equation gives the maximum ambient temperature that still allows maximum stereo power dissipation without violating the LM4952's maximum junction temperature.

$$T_A = T_{JMAX} - P_{DMAX-SE}\theta_{JA} \quad (3)$$

For a typical application with a 12V power supply and an SE 4Ω load, the maximum ambient temperature that allows maximum stereo power dissipation without exceeding the maximum junction temperature is approximately 77°C for the TS package.

$$T_{JMAX} = P_{DMAX-MONOBTL}\theta_{JA} + T_A \quad (4)$$

[Equation 4](#) gives the maximum junction temperature T_{JMAX} . If the result violates the LM4952's 150°C, reduce the maximum junction temperature by reducing the power supply voltage or increasing the load resistance. Further allowance should be made for increased ambient temperatures.

The above examples assume that a device is operating around the maximum power dissipation point. Since internal power dissipation is a function of output power, higher ambient temperatures are allowed as output power or duty cycle decreases.

If the result of [Equation 1](#) is greater than that of [Equation 2](#), then decrease the supply voltage, increase the load impedance, or reduce the ambient temperature. Further, ensure that speakers rated at a nominal 4Ω do not fall below 3Ω. If these measures are insufficient, a heat sink can be added to reduce θ_{JA} . The heat sink can be created using additional copper area around the package, with connections to the ground pins, supply pin and amplifier output pins. Refer to the [Typical Performance Characteristics](#) curves for power dissipation information at lower output power levels.

POWER SUPPLY VOLTAGE LIMITS

Continuous proper operation is ensured by never exceeding the voltage applied to any pin, with respect to ground, as listed in [Absolute Maximum Ratings](#)⁽¹⁾⁽²⁾⁽³⁾.

POWER SUPPLY BYPASSING

As with any power amplifier, proper supply bypassing is critical for low noise performance and high power supply rejection. Applications that employ a voltage regulator typically use a 10μF in parallel with a 0.1μF filter capacitors to stabilize the regulator's output, reduce noise on the supply line, and improve the supply's transient response. However, their presence does not eliminate the need for a local 10μF tantalum bypass capacitance connected between the LM4952's supply pins and ground. Do not substitute a ceramic capacitor for the tantalum. Doing so may cause oscillation. Keep the length of leads and traces that connect capacitors between the LM4952's power supply pin and ground as short as possible.

BYPASS PIN BYPASSING

Connecting a 4.7μF capacitor, C_{BYPASS} , between the BYPASS pin and ground improves the internal bias voltage's stability and improves the amplifier's PSRR. The PSRR improvements increase as the bypass pin capacitor value increases. Too large, however, increases turn-on time. The selection of bypass capacitor values, especially C_{BYPASS} , depends on desired PSRR requirements, click and pop performance (as explained in [SELECTING EXTERNAL COMPONENTS](#)), system cost, and size constraints.

MICRO-POWER SHUTDOWN

The LM4952 features an active-low micro-power shutdown mode. When active, the LM4952's micro-power shutdown feature turns off the amplifier's bias circuitry, reducing the supply current. The low 55μA typical shutdown current is achieved by applying a voltage to the SHUTDOWN pin that is as near to GND as possible. A voltage that is greater than GND may increase the shutdown current.

- (1) All voltages are measured with respect to the GND pin, unless otherwise specified.
- (2) *Absolute Maximum Ratings* indicate limits beyond which damage to the device may occur. *Operating Ratings* indicate conditions for which the device is functional, but do not specify specific performance limits. *Electrical Characteristics* state DC and AC electrical specifications under particular test conditions which specify specific performance limits. This assumes that the device is within the Operating Ratings. Specifications are not specified for parameters where no limit is given, however, the typical value is a good indication of device performance.
- (3) If Military/Aerospace specified devices are required, please contact the Texas Instruments Sales Office/ Distributors for availability and specifications.

There are a few methods to control the micro-power shutdown. These include using a single-pole, single-throw switch (SPST), a microprocessor, or a microcontroller. [Figure 41](#) shows a simple switch-based circuit that can be used to control the LM4952's shutdown function. Select normal amplifier operation by closing the switch. Opening the switch applies GND to the SHUTDOWN pin, activating micro-power shutdown. The switch and resistor ensure that the SHUTDOWN pin will not float. This prevents unwanted state changes. In a system with a microprocessor or a microcontroller, use a digital output to apply the active-state voltage to the SHUTDOWN pin.

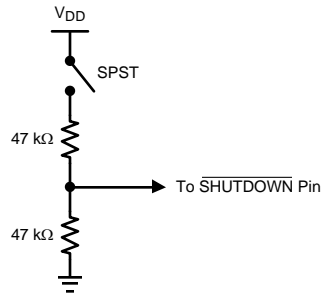

Figure 41. Simple switch and voltage divider generates shutdown control signal

DC VOLUME CONTROL

The LM4952 has an internal stereo volume control whose setting is a function of the DC voltage applied to the DC VOL input pin.

The LM4952 volume control consists of 31 steps that are individually selected by a variable DC voltage level on the volume control pin. As shown in [Figure 42](#), the range of the steps, controlled by the DC voltage, is 20dB to -46dB.

The gain levels are 1dB/step from 20dB to 14dB, 2dB/step from 14dB to -16dB, 3dB/step from -16dB to -27dB, 4dB/step from -27dB to -31dB, 5dB/step from -31dB to -46dB.

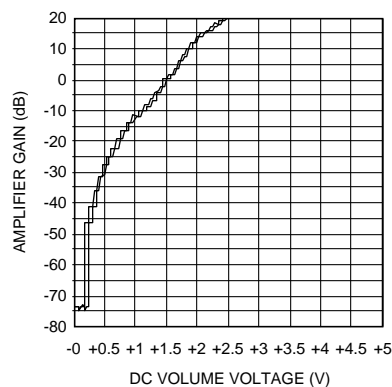

Figure 42. Volume Control Response

Like all volume controls, the LM4952's internal volume control is set while listening to an amplified signal that is applied to an external speaker. The actual voltage applied to the DC VOL input pin is a result of the volume a listener desires. As such, the volume control is designed for use in a feedback system that includes human ears and preferences. This feedback system operates quite well without the need for accurate gain. The user simply sets the volume to the desired level as determined by their ear, without regard to the actual DC voltage that

produces the volume. Therefore, the accuracy of the volume control is not critical, as long as volume changes monotonically and step size is small enough to reach a desired volume that is not too loud or too soft. Since the gain is not critical, there may be a volume variation from part-to-part even with the same applied DC volume control voltage. The gain of a given LM4952 can be set with fixed external voltage, but another LM4952 may require a different control voltage to achieve the same gain. Figure 43 is a curve showing the volume variation of five typical LM4952s as the voltage applied to the DC VOL input pin is varied. For gains between -20dB and +16dB, the typical part-to-part variation is typically ± 1 dB for a given control voltage.

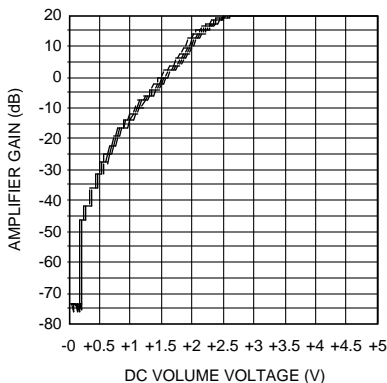
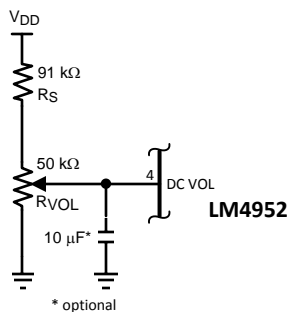

Figure 43. Typical Part-to-Part Gain Variation as a Function of DC Vol Control Voltage

VOLUME CONTROL VOLTAGE GENERATION

Figure 44 shows a simple circuit that can be used to create an adjustable DC control voltage that is applied to the DC Vol input. The 91kΩ series resistor and the 50kΩ potentiometer create a voltage divider between the supply voltage, V_{DD}, and GND. The series resistor's value assumes a 12V power supply voltage. The voltage present at the node between the series resistor and the top of the potentiometer need only be a nominal value of 3.5V and must not exceed 9.5V, as stated in the LM4952's Absolute Maximum Ratings.



Capacitor connected to DC VOL pin minimizes voltage fluctuation when using unregulated supplies that could cause changes in perceived volume setting.

Figure 44. Typical Circuit Used for DC Voltage Volume Control

UNREGULATED POWER SUPPLIES AND THE DC VOL CONTROL

As an amplifier's output power increases, the current that flows from the power supply also increases. If an unregulated power supply is used, its output voltage can decrease ("droop" or "sag") as this current increases. It is not uncommon for an unloaded unregulated 15V power supply connected to the LM4952 to sag by as much as 2V when the amplifier is drawing 1A to 2A while driving 4Ω stereo loads to full power dissipation. Figure 45 is an oscilloscope photo showing an unregulated power supply's voltage sag while powering an LM4952 that is driving 4Ω stereo loads. The amplifier's input is a typical music signal supplied by a CD player. As shown, the sag can be quite significant.

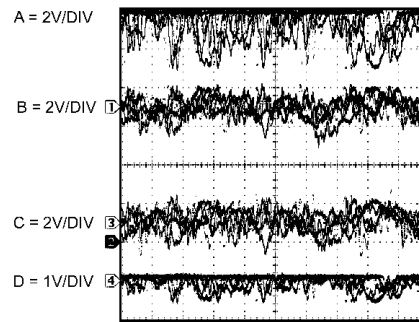

Wave forms shown include V_{DD} (Trace A), $V_{OUT A}$ (Trace B), $V_{OUT B}$ (Trace C), and the DC voltage applied to the DC VOL pin (Trace D).

Figure 45. LM4952 Operating on an Unregulated 12V (Nominal) Power Supply

This sagging supply voltage presents a potential problem when the voltage that drives the DC Vol pin is derived from the voltage supplied by an unregulated power supply. This is the case for the typical volume control circuit (a 50k Ω potentiometer in series with a 91k Ω resistor) shown in [Figure 44](#). The potentiometer's wiper is connected to the DC Vol pin. With this circuit, power supply voltage fluctuations will be seen by the DC Vol input. Though attenuated by the voltage divider action of the potentiometer and the series resistor, these fluctuations may cause perturbations in the perceived volume. An easy and simple solution that suppresses these perturbations is a 10 μ F capacitor connected between the DC Vol pin and ground. See the result of this capacitor in [Figure 46](#). This capacitance can also be supplemented with bulk capacitance in the range of 1000 μ F to 10,000 μ F connected to the unregulated power supply's output. [Figure 48](#) shows how this bulk capacitance minimizes fluctuations on V_{DD} .

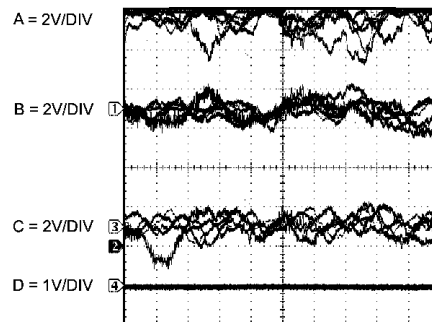

Same conditions and waveforms as shown in [Figure 45](#), except that a 10 μ F capacitor has been connected between the DC VOL pin and GND (Trace D).

Figure 46.

If space constraints preclude the use of a 10 μ F capacitor connected to the DC Vol pin or large amounts of bulk supply capacitance, or if more resistance to the fluctuations is desired, using an LM4040-4.1 voltage reference shown in [Figure 47](#) is recommended. The value of the 91k Ω resistor, already present in the typical volume applications circuit, should be changed to 62k Ω . This sets the LM4040-4.1's bias current at 125 μ A when using a nominal 12V supply, well within the range of current needed by this reference.

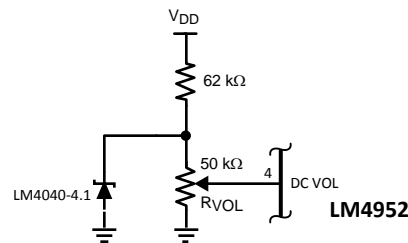

Using an LM4040–4.1 to set the maximum DC volume control voltage and attenuate power supply variations when using unregulated supplies that would otherwise perturb the volume setting.

Figure 47.

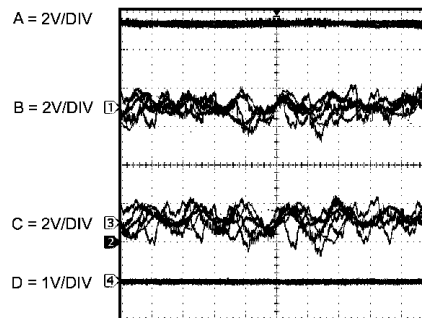

Same conditions and waveforms as shown in Figure 46, except that a 4700µF capacitor has been connected between the V_{DD} pin and GND (Trace A).

Figure 48.

SELECTING EXTERNAL COMPONENTS

Input Capacitor Value Selection

Two quantities determine the value of the input coupling capacitor: the lowest audio frequency that requires amplification and desired output transient suppression.

The amplifier's input resistance and the input capacitor (C_{IN}) produce a high pass filter cutoff frequency that is found using Equation 5.

$$f_{CIN} = 1/(2\pi R_{IN} C_{IN}) \quad (5)$$

As an example when using a speaker with a low frequency limit of 50Hz and based on the LM4952's 44kΩ nominal minimum input resistance, C_{IN} , using Equation 5 is 0.072µF. The 0.39µF C_{INA} shown in Figure 40 allows the LM4952 to drive high efficiency, full range speaker whose response extends below 30Hz.

Similarly, the output coupling capacitor and the load impedance also form a high pass filter. The cutoff frequency formed by these two components is found using Equation 6.

$$f_{COUT} = 1/(2\pi R_{LOAD} C_{OUT}) \quad (6)$$

Expanding on the example above and assuming a nominal speaker impedance of 4Ω, response below 30Hz is assured if the output coupling capacitors have a value, using Equation 6, greater than 1330µF.

Bypass Capacitor Value

Besides minimizing the input capacitor size, careful consideration should be paid to value of C_{BYPASS} , the capacitor connected to the BYPASS pin. Since C_{BYPASS} determines how fast the LM4952 settles to quiescent operation, its value is critical when minimizing turn-on pops. The slower the LM4952's outputs ramp to their quiescent DC voltage (nominally $V_{DD}/2$), the smaller the turn-on pop. Choosing C_{BYPASS} equal to 4.7µF along with a small value of C_{IN} (in the range of 0.1µF to 0.39µF) produces a click-less and pop-less shutdown function. As discussed above, choosing C_{IN} no larger than necessary for the desired bandwidth helps minimize clicks and pops.

Routing Input and BYPASS Capacitor Grounds

Optimizing the LM4952's low distortion performance is easily accomplished by connecting the input signal's ground reference directly to the DDPAK's grounded tab connection. In like manner, the ground lead of the capacitor connected between the BYPASS pin and GND should also be connected to the package's grounded tab.

OPTIMIZING CLICK AND POP REDUCTION PERFORMANCE

The LM4952 contains circuitry that eliminates turn-on and shutdown transients ("clicks and pops"). For this discussion, turn-on refers to either applying the power supply voltage or when the micro-power shutdown mode is deactivated.

As the $V_{DD}/4$ voltage present at the BYPASS pin ramps to its final value, the LM4952's internal amplifiers are muted. Once the voltage at the BYPASS pin reaches $V_{DD}/4$, the amplifiers are unmuted.

The gain of the internal amplifiers remains unity until the voltage on the bypass pin reaches $V_{DD}/4$. As soon as the voltage on the bypass pin is stable, the device becomes fully operational and the amplifier outputs are reconnected to their respective output pins.

In order to eliminate "clicks and pops", all capacitors must be discharged before turn-on. Rapidly switching V_{DD} may not allow the capacitors to fully discharge, which may cause "clicks and pops".

There is a relationship between the value of C_{IN} and C_{BYPASS} that ensures minimum output transient when power is applied or the shutdown mode is deactivated. Best performance is achieved by selecting a C_{BYPASS} value that is greater than twelve times C_{IN} 's value.

RECOMMENDED PRINTED CIRCUIT BOARD LAYOUT

Figure 47 through Figure 49 show the recommended two-layer PC board layout that is optimized for the DDPAK-packaged, SE-configured LM4952 and associated external components. These circuits are designed for use with an external 12V supply and 4Ω(min)(SE) speakers.

These circuit boards are easy to use. Apply 12V and ground to the board's V_{DD} and GND pads, respectively. Connect a speaker between the board's OUT_A and OUT_B outputs and respective GND pins.

Demonstration Board Layout

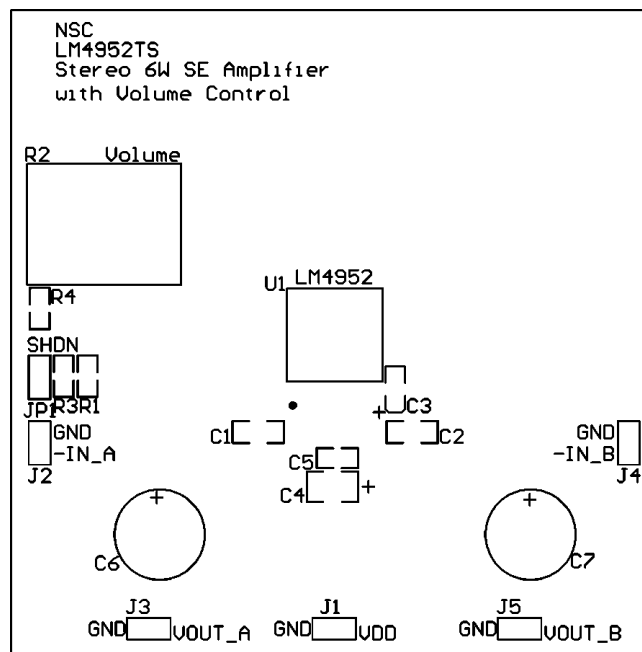

**Figure 49. Recommended TS SE PCB Layout:
Top Silkscreen**

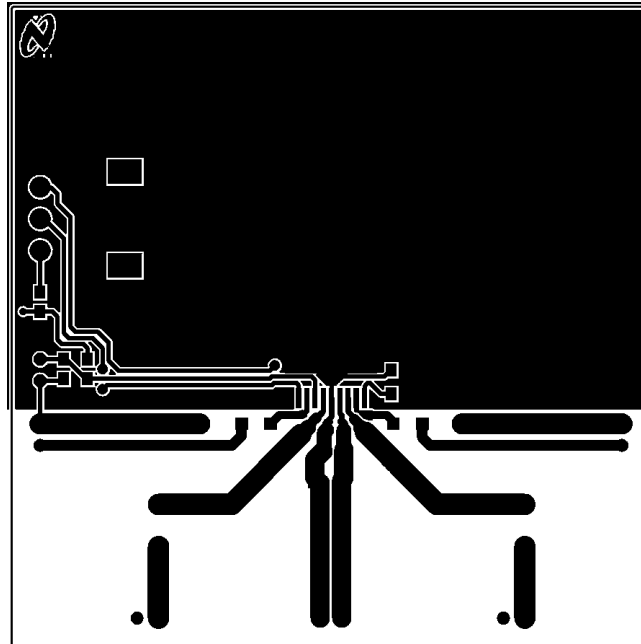

Figure 50. Recommended TS SE PCB Layout:
Top Layer

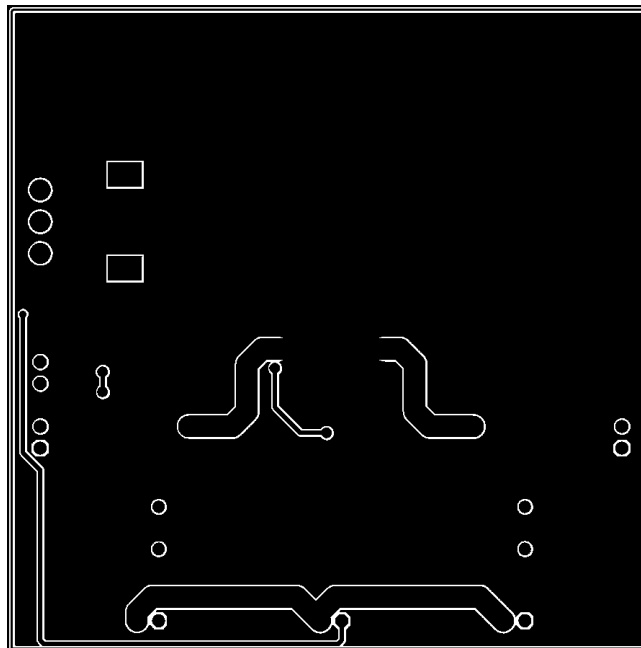



Figure 51. Recommended TS SE PCB Layout:
Bottom Layer

REVISION HISTORY

Changes from Original (May 2013) to Revision A	Page
• Changed layout of National Data Sheet to TI format	19

PACKAGING INFORMATION

Orderable Device	Status (1)	Package Type	Package Drawing	Pins	Package Qty	Eco Plan (2)	Lead finish/ Ball material (6)	MSL Peak Temp (3)	Op Temp (°C)	Device Marking (4/5)	Samples
LM4952TS/NOPB	ACTIVE	DDPAK/ TO-263	KTW	9	45	RoHS-Exempt & Green	SN	Level-3-245C-168 HR	-40 to 85	LM4952TS	
LM4952TSX/NOPB	ACTIVE	DDPAK/ TO-263	KTW	9	500	RoHS-Exempt & Green	SN	Level-3-245C-168 HR	-40 to 85	LM4952TS	

(1) The marketing status values are defined as follows:

ACTIVE: Product device recommended for new designs.

LIFEBUY: TI has announced that the device will be discontinued, and a lifetime-buy period is in effect.

NRND: Not recommended for new designs. Device is in production to support existing customers, but TI does not recommend using this part in a new design.

PREVIEW: Device has been announced but is not in production. Samples may or may not be available.

OBSOLETE: TI has discontinued the production of the device.

(2) **RoHS:** TI defines "RoHS" to mean semiconductor products that are compliant with the current EU RoHS requirements for all 10 RoHS substances, including the requirement that RoHS substance do not exceed 0.1% by weight in homogeneous materials. Where designed to be soldered at high temperatures, "RoHS" products are suitable for use in specified lead-free processes. TI may reference these types of products as "Pb-Free".

RoHS Exempt: TI defines "RoHS Exempt" to mean products that contain lead but are compliant with EU RoHS pursuant to a specific EU RoHS exemption.

Green: TI defines "Green" to mean the content of Chlorine (Cl) and Bromine (Br) based flame retardants meet JS709B low halogen requirements of <=1000ppm threshold. Antimony trioxide based flame retardants must also meet the <=1000ppm threshold requirement.

(3) MSL, Peak Temp. - The Moisture Sensitivity Level rating according to the JEDEC industry standard classifications, and peak solder temperature.

(4) There may be additional marking, which relates to the logo, the lot trace code information, or the environmental category on the device.

(5) Multiple Device Markings will be inside parentheses. Only one Device Marking contained in parentheses and separated by a "~" will appear on a device. If a line is indented then it is a continuation of the previous line and the two combined represent the entire Device Marking for that device.

(6) Lead finish/Ball material - Orderable Devices may have multiple material finish options. Finish options are separated by a vertical ruled line. Lead finish/Ball material values may wrap to two lines if the finish value exceeds the maximum column width.

Important Information and Disclaimer:The information provided on this page represents TI's knowledge and belief as of the date that it is provided. TI bases its knowledge and belief on information provided by third parties, and makes no representation or warranty as to the accuracy of such information. Efforts are underway to better integrate information from third parties. TI has taken and continues to take reasonable steps to provide representative and accurate information but may not have conducted destructive testing or chemical analysis on incoming materials and chemicals. TI and TI suppliers consider certain information to be proprietary, and thus CAS numbers and other limited information may not be available for release.

In no event shall TI's liability arising out of such information exceed the total purchase price of the TI part(s) at issue in this document sold by TI to Customer on an annual basis.

TAPE AND REEL INFORMATION

QUADRANT ASSIGNMENTS FOR PIN 1 ORIENTATION IN TAPE

*All dimensions are nominal

Device	Package Type	Package Drawing	Pins	SPQ	Reel Diameter (mm)	Reel Width W1 (mm)	A0 (mm)	B0 (mm)	K0 (mm)	P1 (mm)	W (mm)	Pin1 Quadrant
LM4952TSX/NOPB	DDPAK/ TO-263	KTW	9	500	330.0	24.4	10.75	14.85	5.0	16.0	24.0	Q2

TAPE AND REEL BOX DIMENSIONS

*All dimensions are nominal

Device	Package Type	Package Drawing	Pins	SPQ	Length (mm)	Width (mm)	Height (mm)
LM4952TSX/NOPB	DDPAK/TO-263	KTW	9	500	367.0	367.0	45.0

TUBE



*All dimensions are nominal

Device	Package Name	Package Type	Pins	SPQ	L (mm)	W (mm)	T (μm)	B (mm)
LM4952TS/NOPB	KTW	TO-263	9	45	502	25	8204.2	9.19

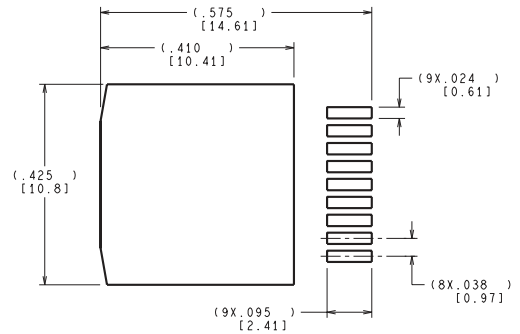
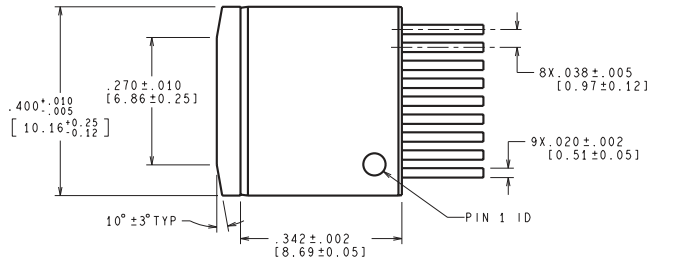
KTW0009A

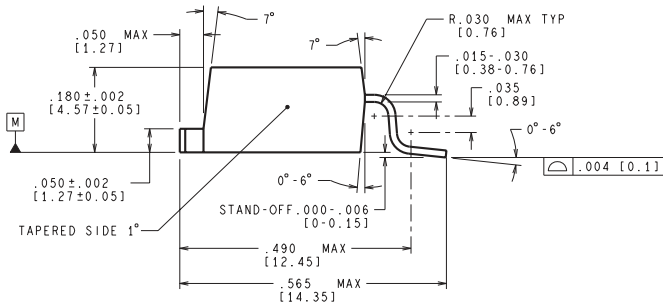

RECOMMENDED LAND PATTERN



CONTROLLING DIMENSION: INCH
DIMENSIONS IN () ARE MILLIMETERS

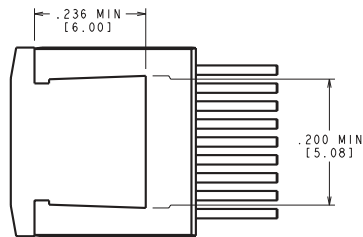

BOTTOM SIDE OF PACKAGE

TS9A (Rev B)

IMPORTANT NOTICE AND DISCLAIMER

TI PROVIDES TECHNICAL AND RELIABILITY DATA (INCLUDING DATA SHEETS), DESIGN RESOURCES (INCLUDING REFERENCE DESIGNS), APPLICATION OR OTHER DESIGN ADVICE, WEB TOOLS, SAFETY INFORMATION, AND OTHER RESOURCES "AS IS" AND WITH ALL FAULTS, AND DISCLAIMS ALL WARRANTIES, EXPRESS AND IMPLIED, INCLUDING WITHOUT LIMITATION ANY IMPLIED WARRANTIES OF MERCHANTABILITY, FITNESS FOR A PARTICULAR PURPOSE OR NON-INFRINGEMENT OF THIRD PARTY INTELLECTUAL PROPERTY RIGHTS.

These resources are intended for skilled developers designing with TI products. You are solely responsible for (1) selecting the appropriate TI products for your application, (2) designing, validating and testing your application, and (3) ensuring your application meets applicable standards, and any other safety, security, regulatory or other requirements.

These resources are subject to change without notice. TI grants you permission to use these resources only for development of an application that uses the TI products described in the resource. Other reproduction and display of these resources is prohibited. No license is granted to any other TI intellectual property right or to any third party intellectual property right. TI disclaims responsibility for, and you will fully indemnify TI and its representatives against, any claims, damages, costs, losses, and liabilities arising out of your use of these resources.

TI's products are provided subject to [TI's Terms of Sale](#) or other applicable terms available either on ti.com or provided in conjunction with such TI products. TI's provision of these resources does not expand or otherwise alter TI's applicable warranties or warranty disclaimers for TI products.

TI objects to and rejects any additional or different terms you may have proposed.

Mailing Address: Texas Instruments, Post Office Box 655303, Dallas, Texas 75265
Copyright © 2022, Texas Instruments Incorporated