

**QSFP/QSFP+**

TE Internal #: 2007456-1

QSFP, QSFP+ & zQSFP+, Cage Assembly, 1 x 3, Customer Applied Gasket, Standard, Data Rate (Max) 14 Gb/s, 3 Port, Pin, QSFP /QSFP+

[View on TE.com >](#)
[Connectors > Pluggable IO Connectors & Cages > QSFP, QSFP+ & zQSFP+](#)
Pluggable I/O Product Type: **Cage Assembly**Port Matrix Configuration: **1 x 3**EMI Containment Feature Type: **Customer Applied Gasket**Thermal Accessory Type Included: **Heat Sink**Included Lightpipe: **No****Features****Product Type Features**

Form Factor	QSFP+
Cage Type	Ganged
Pluggable I/O Product Type	Cage Assembly
Thermal Accessory Type Included	Heat Sink
Connector System	Cable-to-Board
Sealable	No
Connector & Contact Terminates To	Printed Circuit Board

**Configuration Features**

Port Matrix Configuration	1 x 3
Number of Ports	3
Number of Rear EONs per Port Column	1

**Electrical Characteristics**

Data Rate (Max)	14 Gb/s
-----------------	---------

**Body Features**

Heat Sink Finish	Anodized Black
Heat Sink Style	Pin
Heat Sink Height Class	PCI



Heat Sink Height	4.2 mm[.165 in]
------------------	-----------------

### Contact Features

PCB Contact Termination Area Plating Material	Tin
---	-----

### Termination Features

Termination Post & Tail Length	2.2 mm[.086 in]
--------------------------------	-----------------

Termination Method to Printed Circuit Board	Through Hole - Press-Fit
---	--------------------------

### Mechanical Attachment

Connector Mounting Type	Board Mount
-------------------------	-------------

### Housing Features

Cage Material	Nickel Silver
---------------	---------------

### Dimensions

PCB Thickness (Recommended)	1.45 mm[.057 in]
-----------------------------	------------------

### Usage Conditions

Operating Temperature Range	-55 – 105 °C[-67 – 221 °F]
-----------------------------	----------------------------

### Operation/Application

For Use With Pluggable I/O Products	QSFP Cable Assembly, QSFP MSA Compatible Transceiver
-------------------------------------	---

Pluggable I/O Applications	SFP+ Stacked Belly-to-Belly
----------------------------	-----------------------------

Circuit Application	Signal
---------------------	--------

### Industry Standards

UL Flammability Rating	UL 94V-0
------------------------	----------

### Packaging Features

Packaging Method	Box & Tray
------------------	------------

### Other

EMI Containment Feature Type	Customer Applied Gasket
------------------------------	-------------------------

Included Lightpipe	No
--------------------	----

Enhancements	Standard
--------------	----------

### Product Compliance

For compliance documentation, visit the product page on [TE.com](https://www.te.com)>

EU RoHS Directive 2011/65/EU	Compliant
------------------------------	-----------

EU ELV Directive 2000/53/EC	Compliant
-----------------------------	-----------











China RoHS 2 Directive MIIT Order No 32, 2016	No Restricted Materials Above Threshold
EU REACH Regulation (EC) No. 1907/2006	Current ECHA Candidate List: JUNE 2023 (235) Candidate List Declared Against: JUNE 2023 (235) Does not contain REACH SVHC
Halogen Content	Low Halogen - Br, Cl, F, I < 900 ppm per homogenous material. Also BFR/CFR/PVC Free
Solder Process Capability	Not applicable for solder process capability

Product Compliance Disclaimer

This information is provided based on reasonable inquiry of our suppliers and represents our current actual knowledge based on the information they provided. This information is subject to change. The part numbers that TE has identified as EU RoHS compliant have a maximum concentration of 0.1% by weight in homogenous materials for lead, hexavalent chromium, mercury, PBB, PBDE, DBP, BBP, DEHP, DIBP, and 0.01% for cadmium, or qualify for an exemption to these limits as defined in the Annexes of Directive 2011/65/EU (RoHS2). Finished electrical and electronic equipment products will be CE marked as required by Directive 2011/65/EU. Components may not be CE marked. Additionally, the part numbers that TE has identified as EU ELV compliant have a maximum concentration of 0.1% by weight in homogenous materials for lead, hexavalent chromium, and mercury, and 0.01% for cadmium, or qualify for an exemption to these limits as defined in the Annexes of Directive 2000/53/EC (ELV). Regarding the REACH Regulation, the information TE provides on SVHC in articles for this part number is based on the latest European Chemicals Agency (ECHA) 'Guidance on requirements for substances in articles' posted at this URL: <https://echa.europa.eu/guidance-documents/guidance-on-reach>

## Compatible Parts

 <p>TE Part # CAT-C11-H50114 QSFP to QSFP I/O Cable Assembly: 30 AWG</p>	 <p>TE Part # CAT-C11-H50111 QSFP-Four SFP+ I/O Cable Assembly 30 AWG</p>	 <p>TE Part # 1761987-9 ReceptacleConnAssm38PosTape/Re</p>	 <p>TE Part # 2110819-1 QSFP+ Enh EVERCLEAR PT Conn</p>
 <p>TE Part # 1888810-2 EMI/Dust Cover,XFP And QSFP</p>	 <p>TE Part # CAT-C11-H5011 QSFP-Four SFP+ I/O Cable Assembly 28 AWG</p>	 <p>TE Part # CAT-C11-H501142 QSFP to QSFP I/O Cable Assembly: 33 AWG</p>	 <p>TE Part # 2053638-4 C/A, QSFP, 4M, P1-P2, UNEQUALIZED</p>



TE Part # 2202165-4  
QSFP TO QSFP, 26AWG, FDR, 4.0 METER



TE Part # 2202165-5  
QSFP TO QSFP, 26AWG, FDR, 5.0 METER



TE Part # 2829040-2  
QSFP IB EDR, 33AWG, 1.0M



TE Part # 2829040-4  
QSFP IB EDR, 30AWG, 1.0M



TE Part # 2829040-6  
QSFP IB EDR, 30AWG, 2.0M



TE Part # 2829040-7  
QSFP IB EDR, 26AWG, 2.0M



TE Part # 2829040-8  
QSFP IB EDR, 26AWG, 3.0M



TE Part # 2821033-8  
QSFP TO [4]SFP+, 28G, 1M, 33AWG

Also in the Series | QSFP/QSFP+

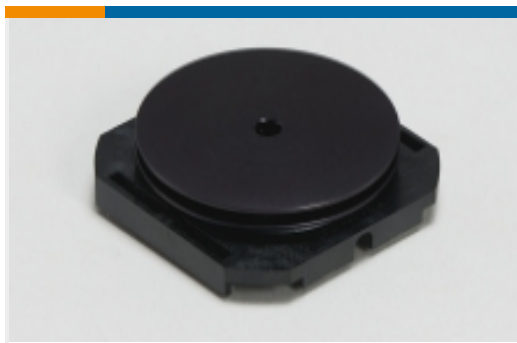

Heat Sinks(1)



Pluggable I/O Cable Assemblies(23)



QSFP, QSFP+ & zQSFP+(168)

Customers Also Bought



TE Part #206070-8  
CABLE CLAMP KIT #17



TE Part #DT04-2P  
REC, 2P, GRY, N



TE Part #DT06-2S  
PLG, 2P, GRY, N



TE Part #W2P  
Wedgelocks: DEUTSCH DT



TE Part #0462-201-16141  
DEUTSCH Solid Contacts



TE Part #282104-1  
AMP SUPERSEAL 1.5MM,  
CONNECTOR HOUSING

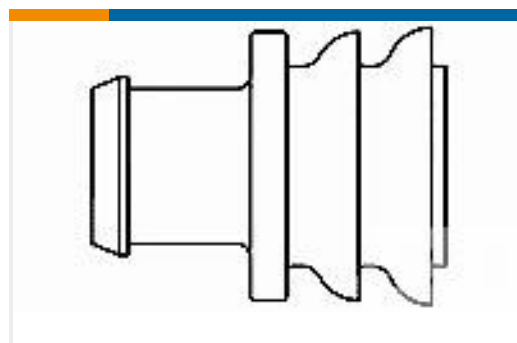

TE Part #281934-2  
SINGLE WIRE SEAL



## Documents

### Product Drawings

[1x3 QSFP Kit Assy Bhnd Bzl,PCI](#)

English

---

### CAD Files

[3D PDF](#)

3D

Customer View Model

[ENG\\_CVM\\_CVM\\_2007456-1\\_F.2d\\_dxf.zip](#)

English

Customer View Model

[ENG\\_CVM\\_CVM\\_2007456-1\\_F.3d\\_igs.zip](#)

English

Customer View Model

[ENG\\_CVM\\_CVM\\_2007456-1\\_F.3d\\_stp.zip](#)

English

By downloading the CAD file I accept and agree to the [Terms and Conditions](#) of use.

---

### Datasheets & Catalog Pages

[1773408-1 Pluggable Input/Output Solutions catalog - QSFP section](#)

English

[4-1773455-5 - Quick Reference Guide QSFP/QSFP+ Solutions](#)

English

---

### Product Specifications

[Product Specification](#)

English

---

### Product Environmental Compliance

[MD\\_2007456-1\\_09192017642\\_dmtec](#)

English

[MD\\_2007456-1\\_09192017642\\_dmtec](#)

English