

## FEATURES

- **2.5Mps Throughput Rate**
- **No Cycle Latency**
- **Guaranteed 12-Bit No Missing Codes**
- **Single 3V or 5V Supply**
- **Low Noise: 73dB SNR**
- **Low Power: 14mW at 2.5Mps and 3V Supply**
- **Low Drift (20ppm/°C Maximum) 2.048V or 4.096V Internal Reference**
- Sleep Mode with < 1µA Typical Supply Current
- Nap Mode with Quick Wake-Up < 1 Conversion
- Separate 1.8V to 5V Digital I/O Supply
- High Speed SPI-Compatible Serial I/O
- Guaranteed Operation from -40°C to 125°C
- 8-Lead TSOT-23 Package

## APPLICATIONS

- Communication Systems
- High Speed Data Acquisition
- Handheld Terminal Interface
- Medical Imaging
- Uninterrupted Power Supplies
- Battery Operated Systems
- Automotive

LT, LT, LTC, LTM, Linear Technology and the Linear logo are registered trademarks of Linear Technology Corporation. All other trademarks are the property of their respective owners.

## DESCRIPTION

The **LTC<sup>®</sup>2313-12** is a 12-bit, 2.5Mps, serial sampling A/D converter that draws only 5mA from a single 3V or 5V supply. The LTC2313-12 contains an integrated low drift reference and reference buffer providing a low cost, high performance (20ppm/°C maximum) and space saving solution. The LTC2313-12 achieves outstanding AC performance of 72.6dB SINAD and -84dB THD while sampling at 2.5Mps. The extremely high sample rate-to-power ratio makes the LTC2313-12 ideal for compact, low power, high speed systems. The supply current decreases at lower sampling rates as the device automatically enters nap mode after conversions.

The LTC2313-12 has a high speed SPI-compatible serial interface that supports 1.8V, 2.5V, 3V and 5V logic. The fast 2.5Mps throughput with no cycle latency makes the LTC2313-12 ideally suited for a wide variety of high speed applications.

### Complete 14-/12-Bit Pin-Compatible SAR ADC Family

	500kps	2.5Mps	4.5Mps	5Mps
14-Bit	LTC2312-14	LTC2313-14	LTC2314-14	
12-Bit	LTC2312-12	LTC2313-12		LTC2315-12
Power 3V/5V	9mW/15mW	14mW/25mW	18mW/31mW	19mW/32mW

## TYPICAL APPLICATION

### 5V Supply, Internal Reference, 2.5Mps, 12-Bit Sampling ADC

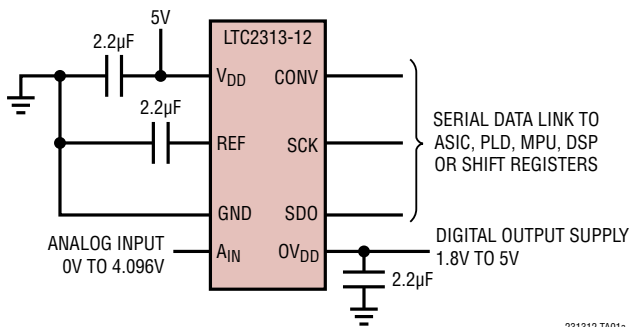

231312 TA01a

### 16k Point FFT, $f_s = 2.5\text{Mps}$ , $f_{IN} = 497\text{kHz}$

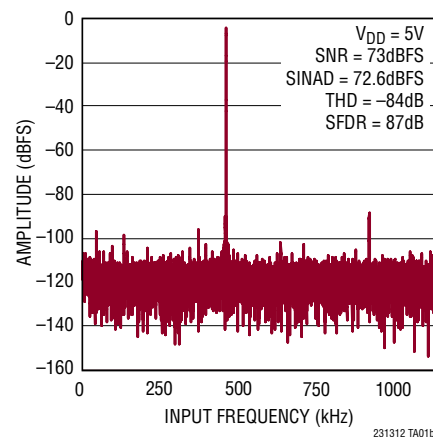

231312 TA01b

231312fb

## ABSOLUTE MAXIMUM RATINGS

(Notes 1, 2)

Supply Voltage ( $V_{DD}$ , $OV_{DD}$ ) .....	6V
Reference (REF) and Analog Input ( $A_{IN}$ ) Voltage (Note 3).....	(-0.3V) to ( $V_{DD} + 0.3V$ )
Digital Input Voltage (Note 3)...	(-0.3V) to ( $OV_{DD} + 0.3V$ )
Digital Output Voltage.....	(-0.3V) to ( $OV_{DD} + 0.3V$ )
Power Dissipation .....	100mW
Operating Temperature Range	
LTC2313C .....	0°C to 70°C
LTC2313I.....	-40°C to 85°C
LTC2313H .....	-40°C to 125°C
Storage Temperature Range .....	-65°C to 150°C
Lead Temperature Range (Soldering, 10 sec).....	300°C

## PIN CONFIGURATION

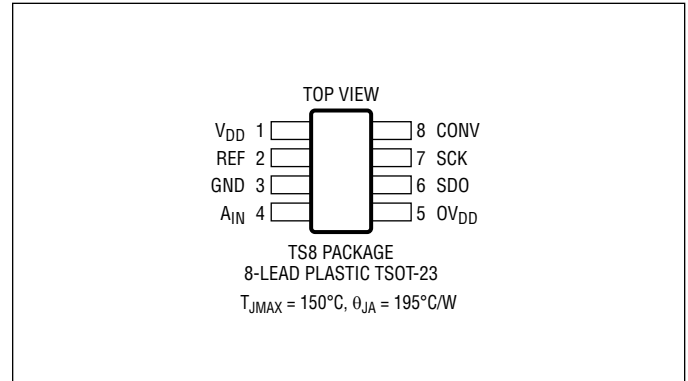

## ORDER INFORMATION

### Lead Free Finish

TAPE AND REEL (MINI)	TAPE AND REEL	PART MARKING*	PACKAGE DESCRIPTION	TEMPERATURE RANGE
LTC2313CTS8-12#TRMPBF	LTC2313CTS8-12#TRPBF	LTFZJ	8-Lead Plastic TSOT-23	0°C to 70°C
LTC2313ITS8-12#TRMPBF	LTC2313ITS8-12#TRPBF	LTFZJ	8-Lead Plastic TSOT-23	-40°C to 85°C
LTC2313HTS8-12#TRMPBF	LTC2313HTS8-12#TRPBF	LTFZJ	8-Lead Plastic TSOT-23	-40°C to 125°C

TRM = 500 pieces. \*Temperature grades are identified by a label on the shipping container.

Consult LTC Marketing for parts specified with wider operating temperature ranges.

Consult LTC Marketing for information on lead based finish parts.

For more information on lead free part marking, go to: <http://www.linear.com/leadfree/>

For more information on tape and reel specifications, go to: <http://www.linear.com/tapeandreel/>

## ELECTRICAL CHARACTERISTICS

The ● denotes the specifications which apply over the full operating temperature range, otherwise specifications are at  $T_A = 25^\circ\text{C}$ . (Note 4)

SYMBOL	PARAMETER	CONDITIONS	MIN	TYP	MAX	UNITS
$V_{AIN}$	Absolute Input Range		● -0.05		$V_{DD} + 0.05$	V
$V_{IN}$	Input Voltage Range	(Note 11)	● 0		$V_{REF}$	V
$I_{IN}$	Analog Input DC Leakage Current		● -1		1	$\mu\text{A}$
$C_{IN}$	Analog Input Capacitance	Sample Mode		13		pF
		Hold Mode		3		pF

## CONVERTER CHARACTERISTICS

The ● denotes the specifications which apply over the full operating temperature range, otherwise specifications are at  $T_A = 25^\circ\text{C}$ . (Note 4)

SYMBOL	PARAMETER	CONDITIONS	MIN	TYP	MAX	UNITS
	Resolution		● 12			Bits
	No Missing Codes		● 12			Bits
	Transition Noise	(Note 6)		0.33		$\text{LSB}_{\text{RMS}}$
INL	Integral Linearity Error	$V_{DD} = 5\text{V}$ (Note 5)	● -1.25	$\pm 0.3$	1.25	LSB
		$V_{DD} = 3\text{V}$ (Note 5)	● -1.5	$\pm 0.4$	1.5	LSB
DNL	Differential Linearity Error	$V_{DD} = 5\text{V}$	● -0.99	$\pm 0.2$	0.99	LSB
		$V_{DD} = 3\text{V}$	● -0.99	$\pm 0.25$	0.99	LSB
	Offset Error	$V_{DD} = 5\text{V}$	● -3.5	$\pm 0.2$	3.5	LSB
		$V_{DD} = 3\text{V}$	● -5	$\pm 0.5$	5	LSB
	Full-Scale Error	$V_{DD} = 5\text{V}$	● -7	$\pm 1$	7	LSB
		$V_{DD} = 3\text{V}$	● -10	$\pm 1.5$	10	LSB
	Total Unadjusted Error	$V_{DD} = 5\text{V}$	● -8	$\pm 1.5$	8	LSB
		$V_{DD} = 3\text{V}$	● -11	$\pm 2$	11	LSB

## DYNAMIC ACCURACY

The ● denotes the specifications which apply over the full operating temperature range, otherwise specifications are at  $T_A = 25^\circ\text{C}$  and  $A_{IN} = -1\text{dBFS}$ . (Note 4)

SYMBOL	PARAMETER	CONDITIONS	MIN	TYP	MAX	UNITS
SINAD	Signal-to-(Noise + Distortion) Ratio	$f_{IN} = 497\text{kHz}$ , $V_{DD} = 5\text{V}$	● 70	72.6		dB
		$f_{IN} = 497\text{kHz}$ , $V_{DD} = 3\text{V}$	● 67.5	70.3		dB
SNR	Signal-to-Noise Ratio	$f_{IN} = 497\text{kHz}$ , $V_{DD} = 5\text{V}$	● 70.5	73		dB
		$f_{IN} = 497\text{kHz}$ , $V_{DD} = 3\text{V}$	● 68	70.6		dB
THD	Total Harmonic Distortion First 5 Harmonics	$f_{IN} = 497\text{kHz}$ , $V_{DD} = 5\text{V}$	●	-84	-76	dB
		$f_{IN} = 497\text{kHz}$ , $V_{DD} = 3\text{V}$	●	-84	-76	dB
SFDR	Spurious Free Dynamic Range	$f_{IN} = 497\text{kHz}$ , $V_{DD} = 5\text{V}$	● 78	87		dB
		$f_{IN} = 497\text{kHz}$ , $V_{DD} = 3\text{V}$	● 77	87		dB
IMD	Intermodulation Distortion 2nd Order Terms 3rd Order Terms	$f_{IN1} = 255\text{kHz}$ , $f_{IN2} = 285\text{kHz}$ , $A_{IN1}, A_{IN2} = -7\text{dBFS}$		-80.4		dBc
				-91.8		dBc
	Full Power Bandwidth	At 3dB At 0.1dB		130 20		MHz MHz
	-3dB Input Linear Bandwidth	SINAD $\geq 68\text{dB}$		5		MHz
$t_{AP}$	Aperture Delay			1		ns
$t_{JITTER}$	Aperture Jitter			10		ps <sub>RMS</sub>

## REFERENCE INPUT/OUTPUT

The ● denotes the specifications which apply over the full operating temperature range, otherwise specifications are at  $T_A = 25^\circ\text{C}$ . (Note 4)

SYMBOL	PARAMETER	CONDITIONS	MIN	TYP	MAX	UNITS
$V_{REF}$	$V_{REF}$ Output Voltage	$2.7\text{V} \leq V_{DD} \leq 3.6\text{V}$	● 2.040	2.048	2.056	V
		$4.75 \leq V_{DD} \leq 5.25\text{V}$	● 4.080	4.096	4.112	V
	$V_{REF}$ Temperature Coefficient			7	20	ppm/°C
	$V_{REF}$ Output Resistance	Normal Operation, $I_{LOAD} = 0\text{mA}$ to $5\text{mA}$ Overdrive Condition ( $V_{REFIN} \geq V_{REFOUT} + 50\text{mV}$ )		1		$\Omega$
				52		$\text{k}\Omega$
	$V_{REF}$ Line Regulation	$2.7\text{V} \leq V_{DD} \leq 3.6\text{V}$ $4.75 \leq V_{DD} \leq 5.25\text{V}$		0.4		mV/V
					0.2	
	$V_{REF}$ 2.048V/4.096V Supply Threshold			4.15		V
	$V_{REF}$ 2.048V/4.096V Supply Threshold Hysteresis			150		mV
	$V_{REF}$ Input Voltage Range (External Reference Input)	$2.7\text{V} \leq V_{DD} \leq 3.6\text{V}$ $4.75 \leq V_{DD} \leq 5.25\text{V}$	● $V_{REF} + 50\text{mV}$		$V_{DD}$	V
			● $V_{REF} + 50\text{mV}$		4.3	

## DIGITAL INPUTS AND DIGITAL OUTPUTS

The ● denotes the specifications which apply over the full operating temperature range, otherwise specifications are at  $T_A = 25^\circ\text{C}$ . (Note 4)

SYMBOL	PARAMETER	CONDITIONS	MIN	TYP	MAX	UNITS
$V_{IH}$	High Level Input Voltage		● $0.8 \cdot OV_{DD}$			V
$V_{IL}$	Low Level Input Voltage				● $0.2 \cdot OV_{DD}$	V
$I_{IN}$	Digital Input Current	$V_{IN} = 0\text{V}$ to $OV_{DD}$	● -10		10	$\mu\text{A}$
$C_{IN}$	Digital Input Capacitance			5		pF
$V_{OH}$	High Level Output Voltage	$I_O = -500\mu\text{A}$ (Source)	● $OV_{DD} - 0.2$			V
$V_{OL}$	Low Level Output Voltage	$I_O = 500\mu\text{A}$ (Sink)	●		0.2	V
$I_{OZ}$	Hi-Z Output Leakage Current	$V_{OUT} = 0\text{V}$ to $OV_{DD}$ , CONV = High	● -10		10	$\mu\text{A}$
$C_{OZ}$	Hi-Z Output Capacitance	CONV = High		4		pF
$I_{SOURCE}$	Output Source Current	$V_{OUT} = 0\text{V}$ , $OV_{DD} = 1.8\text{V}$		-20		mA
$I_{SINK}$	Output Sink Current	$V_{OUT} = OV_{DD} = 1.8\text{V}$		20		mA

## POWER REQUIREMENTS

The ● denotes the specifications which apply over the full operating temperature range, otherwise specifications are at  $T_A = 25^\circ\text{C}$ . (Note 4)

SYMBOL	PARAMETER	CONDITIONS	MIN	TYP	MAX	UNITS
$V_{DD}$	Supply Voltage	3V Operational Range	● 2.7	3	3.6	V
		5V Operational Range	● 4.75	5	5.25	V
$OV_{DD}$	Digital Output Supply Voltage		● 1.71		5.25	V
$I_{TOTAL} = I_{VDD} + I_{OVDD}$	Supply Current, Static Mode Operational Mode Nap Mode Sleep Mode	CONV = 0V, SCK = 0V	●	3.4	4.4	mA
			●	5	6	mA
			●	2		mA
			●	0.2	5	$\mu\text{A}$
$P_D$	Power Dissipation, Static Mode Operational Mode Nap Mode Sleep Mode	CONV = 0V, SCK = 0V	●	17	22	mW
			●	25	30	mW
			●	10		mW
			●	1	25	$\mu\text{W}$

## ADC TIMING CHARACTERISTICS

The ● denotes the specifications which apply over the full operating temperature range, otherwise specifications are at  $T_A = 25^\circ\text{C}$ . (Note 4)

SYMBOL	PARAMETER	CONDITIONS	MIN	TYP	MAX	UNITS
$f_{\text{SAMPLE(MAX)}}$	Maximum Sampling Frequency	(Notes 7, 8)	●		2.5	MHz
$f_{\text{SCK}}$	Shift Clock Frequency	(Notes 7, 8)	●		90	MHz
$t_{\text{SCK}}$	Shift Clock Period		●	11.1		ns
$t_{\text{THROUGHPUT}}$	Minimum Throughput Time, $t_{\text{ACQ}} + t_{\text{CONV}}$		●		400	ns
$t_{\text{CONV}}$	Conversion Time		●	247		ns
$t_{\text{ACQ}}$	Acquisition Time		●	153		ns
$t_1$	Minimum CONV Pulse Width	(Note 7) Valid for Nap and Sleep Mode Only	●	10		ns
$t_2$	SCK↑ Setup Time After CONV↓	(Note 7)	●	10		ns
$t_3$	SDO Enable Time After CONV↓	(Notes 7, 8)	●		10	ns
$t_4$	SDO Data Valid Access Time after SCK↓	(Notes 7, 8, 9)	●		9.1	ns
$t_5$	SCK Low Time		●	4		ns
$t_6$	SCK High Time		●	4		ns
$t_7$	SDO Data Valid Hold Time After SCK↓	(Notes 7, 8, 9)	●	1		ns
$t_8$	SDO into Hi-Z State Time After CONV↑	(Notes 7, 8, 10)	●	3	10	ns
$t_9$	CONV↑ Quiet Time After 12th SCK↓	(Note 7)	●	15		ns
$t_{\text{WAKE-NAP}}$	Power-Up Time from Nap Mode	See Nap Mode Section		50		ns
$t_{\text{WAKE-SLEEP}}$	Power-Up Time from Sleep Mode	See Sleep Mode Section		1.1		ms

**Note 1.** Stresses beyond those listed under Absolute Maximum Ratings may cause permanent damage to the device. Exposure to any Absolute Maximum Rating condition for extended periods may affect device reliability and lifetime.

**Note 2.** All voltage values are with respect to ground.

**Note 3.** When these pin voltages are taken below ground or above  $V_{\text{DD}}$  ( $A_{\text{IN}}$ , REF) or  $OV_{\text{DD}}$  (SCK, CONV, SDO) they will be clamped by internal diodes. This product can handle input currents up to 100mA below ground or above  $V_{\text{DD}}$  or  $OV_{\text{DD}}$  without latch-up.

**Note 4.**  $V_{\text{DD}} = 5\text{V}$ ,  $OV_{\text{DD}} = 2.5\text{V}$ ,  $f_{\text{SAMPL}} = 2.5\text{MHz}$ ,  $f_{\text{SCK}} = 90\text{MHz}$ ,  $A_{\text{IN}} = -1\text{dBFS}$  and internal reference unless otherwise noted.

**Note 5.** Integral nonlinearity is defined as the deviation of a code from a straight line passing through the actual endpoints of the transfer curve. The deviation is measured from the center of the quantization band.

**Note 6.** Typical RMS noise at code transitions.

**Note 7.** Parameter tested and guaranteed at  $OV_{\text{DD}} = 2.5\text{V}$ . All input signals are specified with  $t_r = t_f = 1\text{ns}$  (10% to 90% of  $OV_{\text{DD}}$ ) and timed from a voltage level of  $OV_{\text{DD}}/2$ .

**Note 8.** All timing specifications given are with a 10pF capacitance load. Load capacitances greater than this will require a digital buffer.

**Note 9.** The time required for the output to cross the  $V_{\text{OH}}$  or  $V_{\text{OL}}$  voltage.

**Note 10.** Guaranteed by design, not subject to test.

**Note 11.** Recommended operating conditions.

# LTC2313-12

## TYPICAL PERFORMANCE CHARACTERISTICS $T_A = 25^\circ\text{C}$ , $V_{DD} = 5\text{V}$ , $0V_{DD} = 2.5\text{V}$ , $f_{\text{SAMPL}} = 2.5\text{Mpsps}$ , unless otherwise noted.

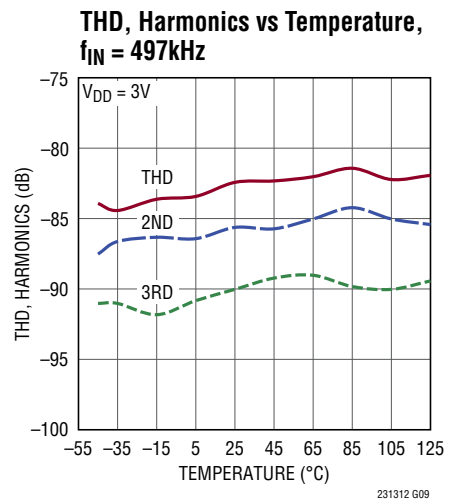
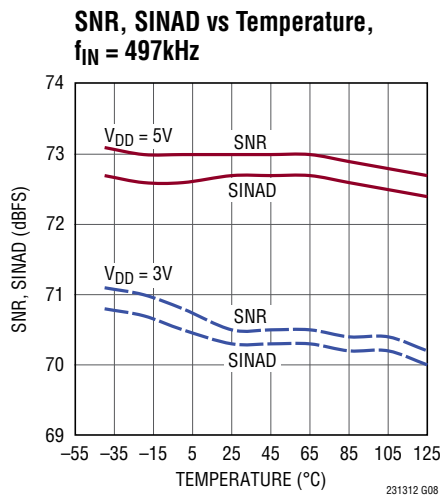
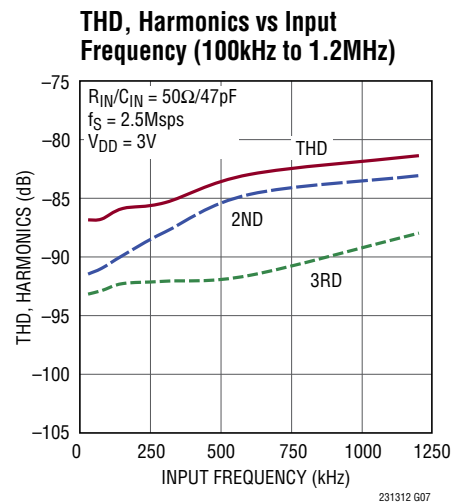
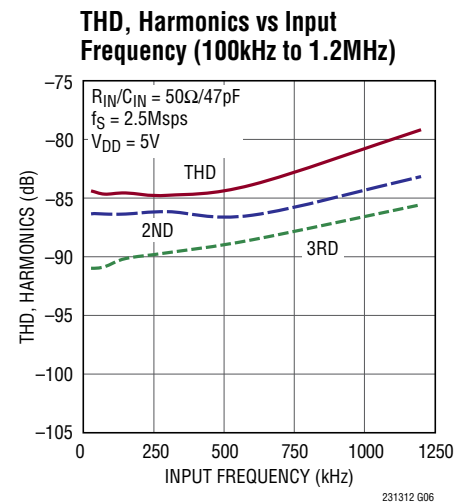
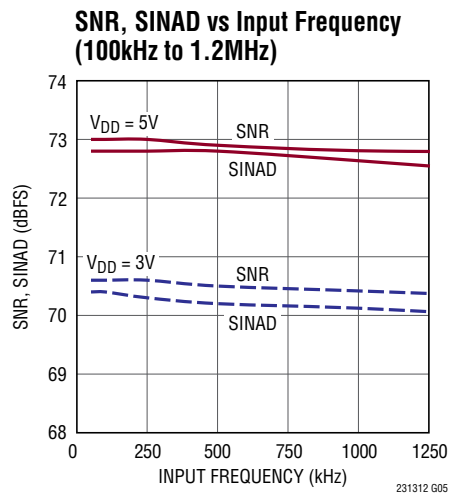
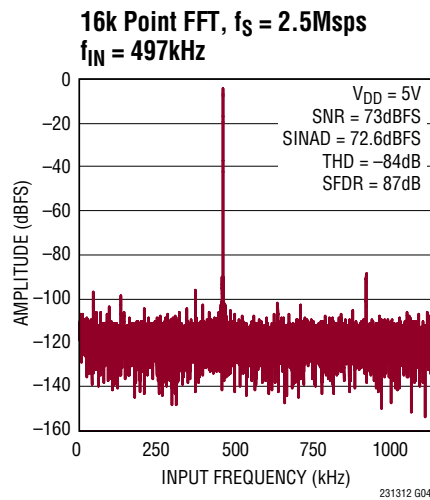
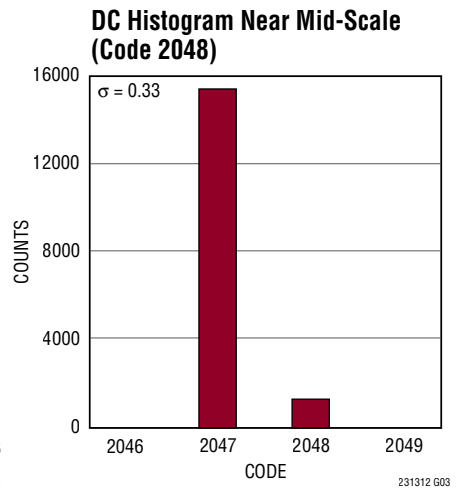
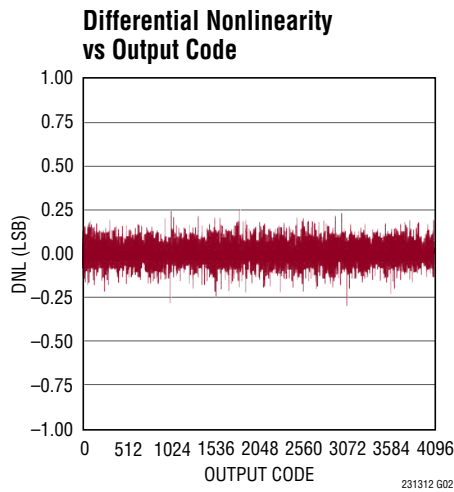
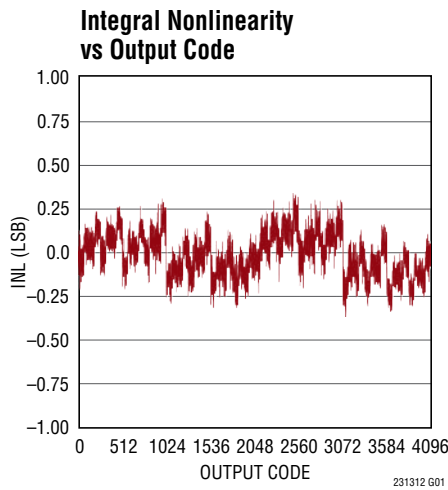

231312fb

**TYPICAL PERFORMANCE CHARACTERISTICS**  $T_A = 25^\circ\text{C}$ ,  $V_{DD} = 5\text{V}$ ,  $OV_{DD} = 2.5\text{V}$ ,  $f_{\text{SAMPL}} = 2.5\text{Msps}$ , unless otherwise noted.

**THD, Harmonics vs Temperature,**  
 $f_{\text{IN}} = 497\text{kHz}$

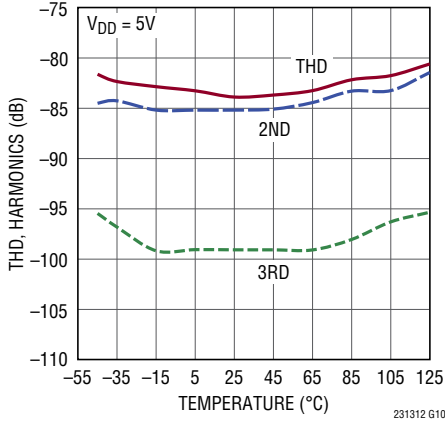

**SNR, SINAD vs Reference Voltage**  
 $f_{\text{IN}} = 497\text{kHz}$

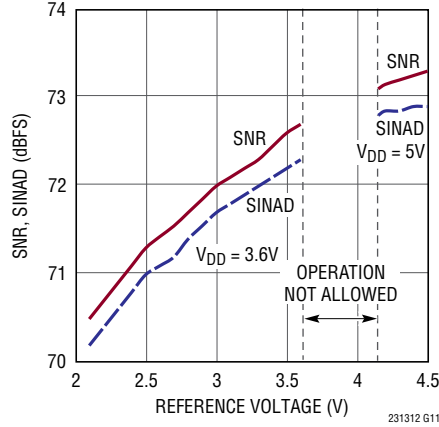

**Reference Current vs Reference Voltage**

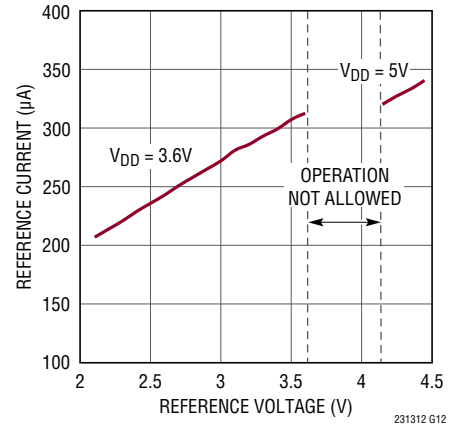

**Full-Scale Error vs Temperature**

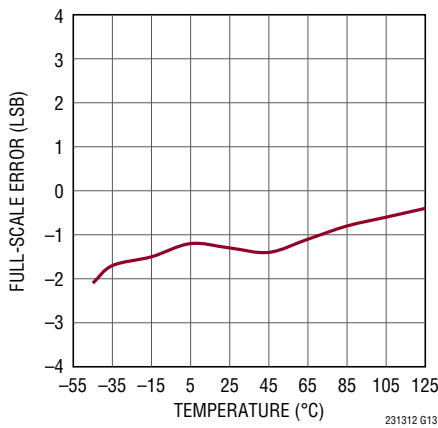

**Offset Error vs Temperature**

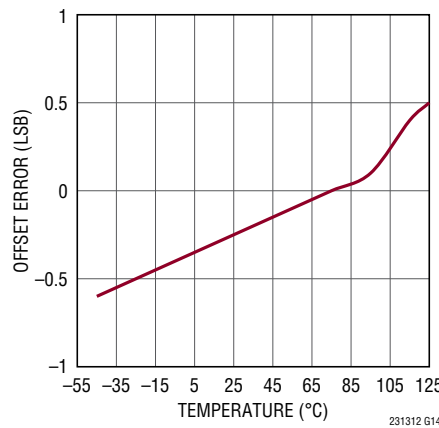

**Supply Current vs Temperature**

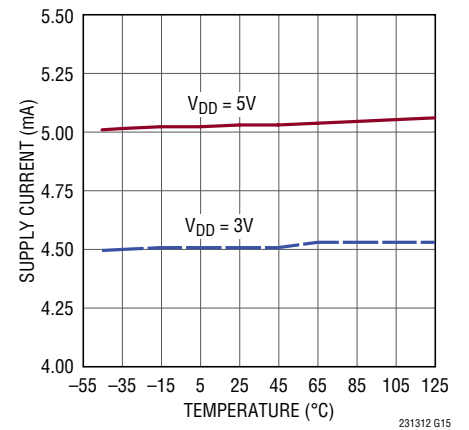

**Shutdown Current vs Temperature**

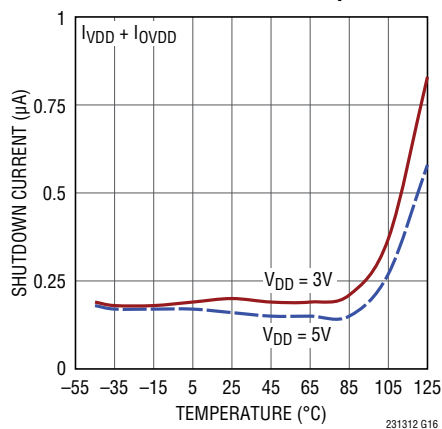

**Supply Current vs Sample Rate**

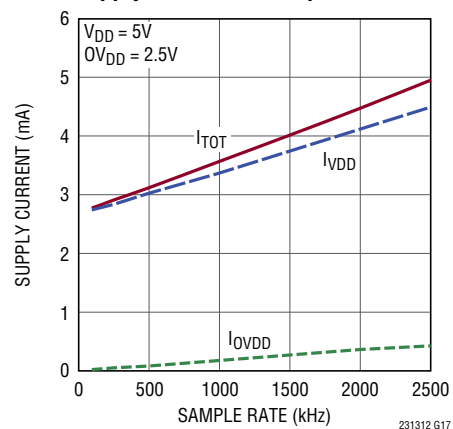

## TYPICAL PERFORMANCE CHARACTERISTICS $T_A = 25^\circ\text{C}$ , $V_{DD} = 5\text{V}$ , $OV_{DD} = 2.5\text{V}$ , $f_{\text{SAMPL}} = 2.5\text{MSPS}$ , unless otherwise noted.

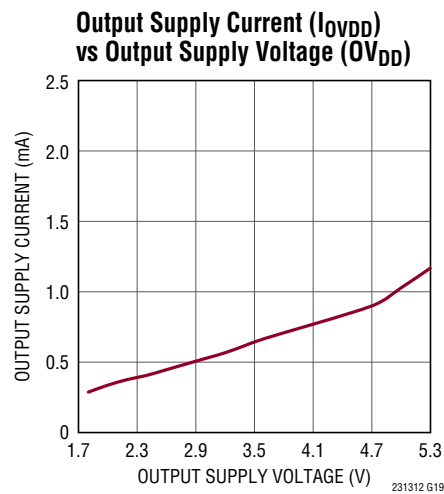
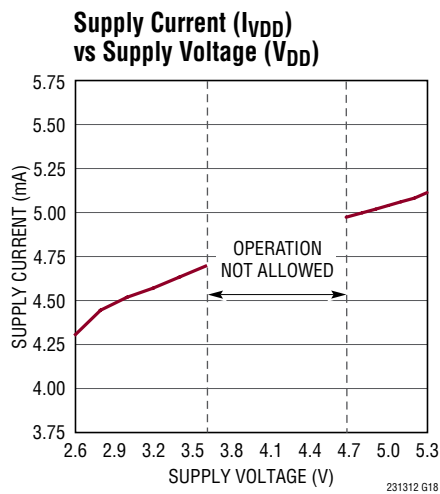

## PIN FUNCTIONS

**$V_{DD}$  (Pin 1):** Power Supply. The ranges of  $V_{DD}$  are 2.7V to 3.6V and 4.75V to 5.25V. Bypass  $V_{DD}$  to GND with a 2.2 $\mu\text{F}$  ceramic chip capacitor.

**REF (Pin 2):** Reference Input/Output. The REF pin voltage defines the input span of the ADC, 0V to  $V_{REF}$ . By default, REF is an output pin and produces a reference voltage  $V_{REF}$  of either 2.048V or 4.096V depending on  $V_{DD}$  (see Table 2). Bypass to GND with a 2.2 $\mu\text{F}$ , low ESR, high quality ceramic chip capacitor. The REF pin may be overdriven with a voltage at least 50mV higher than the internal reference voltage output.

**GND (Pin 3):** Ground. The GND pin must be tied directly to a solid ground plane.

**$A_{IN}$  (Pin 4):** Analog Input.  $A_{IN}$  is a single-ended input with respect to GND with a range from 0V to  $V_{REF}$ .

**$OV_{DD}$  (Pin 5):** I/O Interface Digital Power. The  $OV_{DD}$  range is 1.71V to 5.25V. This supply is nominally set to the same supply as the host interface (1.8V, 2.5V, 3.3V or 5V). Bypass to GND with a 2.2 $\mu\text{F}$  ceramic chip capacitor.

**SDO (Pin 6):** Serial Data Output. The A/D conversion result is shifted out on SDO as a serial data stream with the MSB first through the LSB last. The data stream consists of 12 bits of conversion data followed by trailing zeros. There is no cycle latency. Logic levels are determined by  $OV_{DD}$ .

**SCK (Pin 7):** Serial Data Clock Input. The SCK serial clock synchronizes the serial data transfer. SDO data transitions on the falling edge of SCK. Logic levels are determined by  $OV_{DD}$ .

**CONV (Pin 8):** Convert Input. This active high signal starts a conversion on the rising edge. The conversion is timed via an internal oscillator. The device automatically powers down following the conversion process. The SDO pin is in high impedance when CONV is a logic high. Bringing CONV low enables the SDO pin and outputs the MSB. Subsequent bits of the conversion data are read out serially on the falling edge of SCK. A logic low on CONV also places the sample-and-hold into sample mode. Logic levels are determined by  $OV_{DD}$ .



# BLOCK DIAGRAM

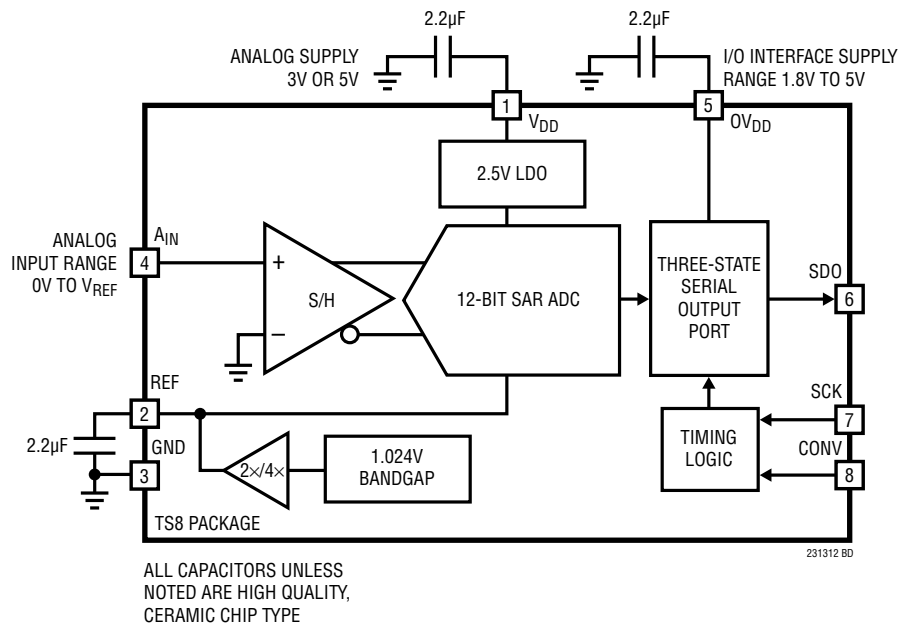

# TIMING DIAGRAMS

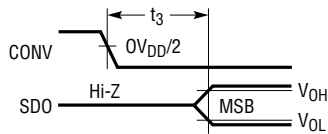

Figure 1. SDO Enabled After CONV↓

231312 TD01

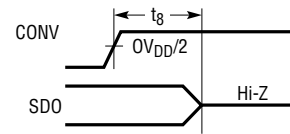

Figure 2. SDO Into Hi-Z After CONV↑

231312 TD02

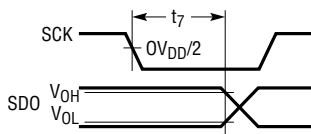

Figure 3. SDO Data Valid Hold After SCK↓

231312 TD03

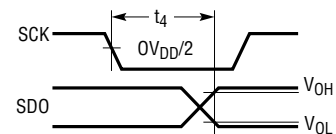

Figure 4. SDO Data Valid Access After SCK↓

231312 TD04

## APPLICATIONS INFORMATION

### Overview

The LTC2313-12 is a low noise, high speed, 12-bit successive approximation register (SAR) ADC. The LTC2313-12 operates from a single 3V or 5V supply and provides a low drift (20ppm/°C maximum), internal reference and reference buffer. The internal reference buffer is automatically configured with a 2.048V span in low supply range (2.7V to 3.6V) and with a 4.096V span in the high supply range (4.75V to 5.25V). The LTC2313-12 samples up to a 2.5Msps rate and supports a 90MHz serial data read clock. The LTC2313-12 achieves excellent dynamic performance (72.6dB SINAD, -84dB THD) while dissipating only 25mW from a 5V supply at the 2.5Msps conversion rate. The LTC2313-12 outputs the conversion data with no cycle latency onto the SDO pin. The SDO pin output logic levels are supplied by the dedicated  $OV_{DD}$  supply pin which has a wide supply range (1.71V to 5.25V) allowing the LTC2313-12 to communicate with 1.8V, 2.5V, 3V or 5V systems. The LTC2313-12 automatically switches to nap mode following the conversion process to save power. The device also provides a sleep power-down mode through serial interface control to reduce power dissipation during long inactive periods.

### Serial Interface

The LTC2313-12 communicates with microcontrollers, DSPs and other external circuitry via a 3-wire interface. A rising CONV edge starts the conversion process which is timed via an internal oscillator. Following the conversion process the device automatically switches to nap mode to save power as shown in Figure 7. This feature saves considerable power for the LTC2313-12 operating at lower sampling rates. As shown in Figures 5 and 6, it is recommended to hold SCK static low or high during  $t_{CONV}$ . A falling CONV edge enables SDO and outputs the MSB. Subsequent SCK falling edges clock out the remaining data as shown in Figures 5 and 6. CONV must be held high for the minimum conversion time,  $t_{CONV(MIN)}$ . Data is serially output MSB first through LSB last, followed by trailing zeros if further SCK falling edges are applied.

### Serial Data Output (SDO)

The SDO output is always forced into the high impedance state while CONV is high. The falling edge of CONV enables SDO and also places the sample and hold into sample mode. The A/D conversion result is shifted out on the SDO pin as a serial data stream with the MSB first. The MSB is output on SDO on the falling edge of CONV. Delay  $t_3$  is the data valid access time for the MSB. The following 11 bits of conversion data are shifted out on SDO on the falling edge of SCK. Delay  $t_4$  is the data valid access time for output data shifted out on the falling edge of SCK. There is no data latency. Subsequent falling SCK edges applied after the LSB is output will output zeros indefinitely on the SDO pin.

The output swing on the SDO pin is controlled by the  $OV_{DD}$  pin voltage and supports a wide operating range from 1.71V to 5.25V independent of the  $V_{DD}$  pin voltage.

### Power Considerations

The LTC2313-12 provides two sets of power supply pins: the analog power supply ( $V_{DD}$ ) and the digital input/output interface power supply ( $OV_{DD}$ ). The flexible  $OV_{DD}$  supply allows the LTC2313-12 to communicate with any digital logic operating between 1.8V and 5V, including 2.5V and 3.3V systems.

### Entering Nap/Sleep Mode

Pulsing CONV two times and holding SCK static places the LTC2313-12 into nap mode. Pulsing CONV four times and holding SCK static places the LTC2313-12 into sleep mode. In sleep mode, all bias circuitry is shut down, including the internal bandgap and reference buffer, and only leakage currents remain (0.2 $\mu$ A typical). Because the reference buffer is externally bypassed with a large capacitor (2.2 $\mu$ F), the LTC2313-12 requires a significant wait time (1.1ms) to recharge this capacitance before an accurate conversion can be made. In contrast, nap mode does not power down the internal bandgap or reference buffer allowing for a fast wake-up and accurate conversion within one conversion clock cycle. Supply current during nap mode is nominally 2mA.

# APPLICATIONS INFORMATION

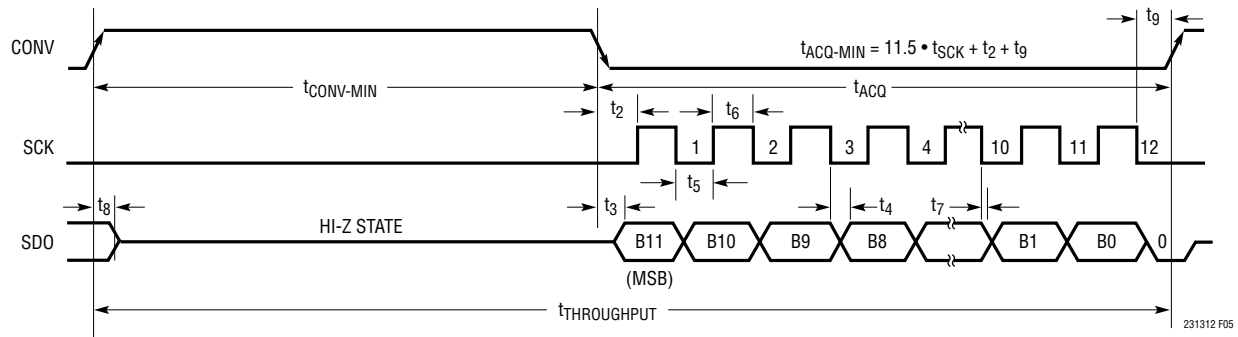

Figure 5. LTC2313-12 Serial Interface Timing Diagram (SCK Low During  $t_{conv}$ )

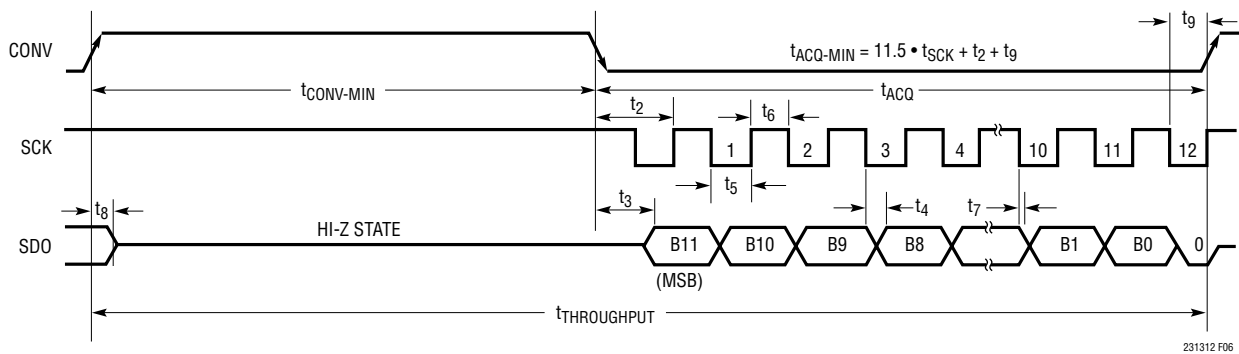

Figure 6. LTC2313-12 Serial Interface Timing Diagram (SCK High During  $t_{conv}$ )

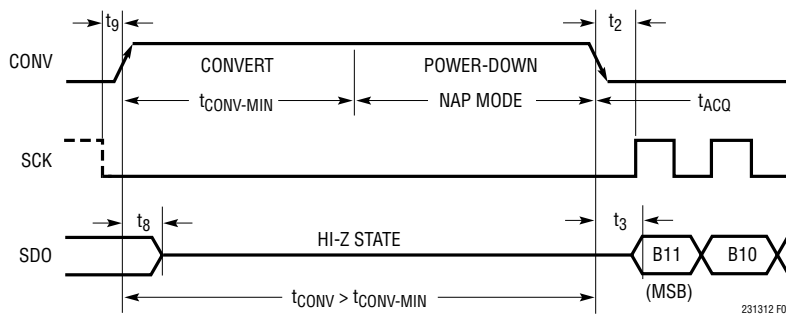

Figure 7. LTC2313-12 Nap Mode Power-Down Following Conversion for  $t_{conv} > t_{conv-min}$

## APPLICATIONS INFORMATION

### Exiting Nap/Sleep Mode

Waking up the LTC2313-12 from either nap or sleep mode, as shown in Figures 8 and 9, requires SCK to be pulsed one time. A conversion cycle ( $t_{ACQ}$ ) may be started immediately following nap mode as shown in Figure 8. A period of time allowing the reference voltage to recover must follow waking up from sleep mode as shown in Figure 9. The wait period required before initiating a conversion for the recommended value of  $C_{REF}$  of  $2.2\mu\text{F}$  is  $1.1\text{ms}$ .

### Power Supply Sequencing

The LTC2313-12 does not have any specific power supply sequencing requirements. Care should be taken to observe the maximum voltage relationships described in the Absolute Maximum Ratings section.

### Single-Ended Analog Input Drive

The analog input of the LTC2313-12 is easy to drive. The input draws only one small current spike while charging the sample-and-hold capacitor following the falling edge of CONV. During the conversion, the analog input draws only a small leakage current. If the source impedance of the driving circuit is low, then the input of the LTC2313-12 can be driven directly. As the source impedance increases, so will the acquisition time.

with high source impedance, a buffer amplifier should be used. The main requirement is that the amplifier driving the analog input must settle after the small current spike before the next conversion starts. Settling time must be less than  $t_{ACQ-MIN}$  ( $153\text{ns}$ ) for full performance at the maximum throughput rate. While choosing an input amplifier, also keep in mind the amount of noise and harmonic distortion the amplifier contributes.

### Choosing an Input Amplifier

Choosing an input amplifier is easy if a few requirements are taken into consideration. First, to limit the magnitude of the voltage spike seen by the amplifier from charging the sampling capacitor, choose an amplifier that has a low output impedance ( $<50\Omega$ ) at the closed-loop bandwidth frequency. For example, if an amplifier is used in a gain of 1 and has a unity-gain bandwidth of  $50\text{MHz}$ , then the output impedance at  $50\text{MHz}$  must be less than  $50\Omega$ . The second requirement is that the closed-loop bandwidth must be greater than  $50\text{MHz}$  to ensure adequate small signal settling for full throughput rate. If slower op amps are used, more time for settling can be provided by increasing the time between conversions. The best choice for an op amp to drive the LTC2313-12 will depend on the application. Generally, applications fall into two categories: AC applications where dynamic specifications are most

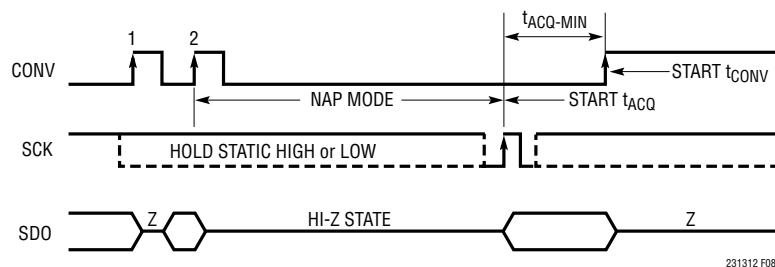

Figure 8. LTC2313-12 Entering/Exiting Nap Mode

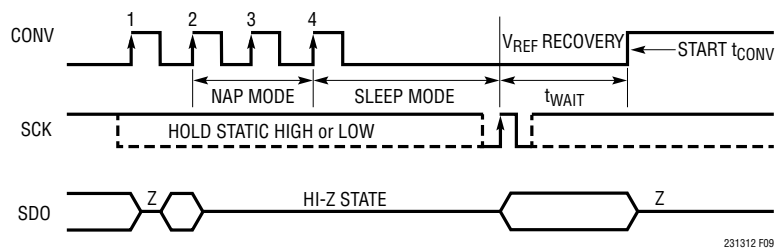

Figure 9. LTC2313-12 Entering/Exiting Sleep Mode

## APPLICATIONS INFORMATION

critical and time domain applications where DC accuracy and settling time are most critical. The following list is a summary of the op amps that are suitable for driving the LTC2313-12. (More detailed information is available on the Linear Technology website at [www.linear.com](http://www.linear.com)):

**LT6230:** 215MHz GBWP,  $-80\text{dBc}$  Distortion at 1MHz, Unity-Gain Stable, Rail-to-Rail Input and Output, 3.5mA/Amplifier,  $1.1\text{nV}/\sqrt{\text{Hz}}$ .

**LT6200:** 165MHz GBWP,  $-85\text{dBc}$  Distortion at 1MHz, Unity-Gain Stable, R-R In and Out, 15mA/Amplifier,  $0.95\text{nV}/\sqrt{\text{Hz}}$ .

**LT1818/1819:** 400MHz GBWP,  $-85\text{dBc}$  Distortion at 5MHz, Unity-Gain Stable, 9mA/Amplifier, Single/Dual Voltage Mode Operational Amplifier.

### Input Drive Circuits

The analog input of the LTC2313-12 is designed to be driven single-ended with respect to GND. A low impedance source can directly drive the high impedance analog input of the LTC2313-12 without gain error. A high impedance source should be buffered to minimize settling time during acquisition and to optimize the distortion performance of the ADC.

For best performance, a buffer amplifier should be used to drive the analog input of the LTC2313-12. The amplifier provides low output impedance to allow for fast settling of the analog signal during the acquisition phase. It also provides isolation between the signal source and the ADC inputs which draw a small current spike during acquisition.

### Input Filtering

The noise and distortion of the buffer amplifier and other circuitry must be considered since they add to the ADC noise and distortion. Noisy input circuitry should be filtered prior to the analog inputs to minimize noise. A simple 1-pole RC filter is sufficient for many applications.

Large filter RC time constants slow down the settling at the analog inputs. It is important that the overall RC time constants be short enough to allow the analog inputs to completely settle to  $>12$ -bit resolution within the minimum acquisition time ( $t_{\text{ACQ-MIN}}$ ) of 153ns.

A simple 1-pole RC filter is sufficient for many applications. For example, Figure 10 shows a recommended single-ended buffered drive circuit using the LT1818 in unity gain

mode. The 47pF capacitor from  $A_{\text{IN}}$  to ground and 50 $\Omega$  source resistor limits the input bandwidth to 68MHz. The 47pF capacitor also acts as a charge reservoir for the input sample-and-hold and isolates the LT1818 from sampling glitch kick-back. The 50 $\Omega$  source resistor is used to help stabilize the settling response of the drive amplifier. When choosing values of source resistance and shunt capacitance, the drive amplifier data sheet should be consulted and followed for optimum settling response. If lower input bandwidths are desired, care should be taken to optimize the settling response of the driver amplifier with higher values of shunt capacitance or series resistance. High quality capacitors and resistors should be used in the RC filter since these components can add distortion. NPO/COG and silver mica type dielectric capacitors have excellent linearity. Carbon surface mount resistors can generate distortion from self heating and from damage that may occur during soldering. Metal film surface mount resistors are much less susceptible to both problems. When high amplitude unwanted signals are close in frequency to the desired signal frequency, a multiple pole filter is required. High external source resistance, combined with external shunt capacitance at Pin 4 and 13pF of input capacitance on the LTC2313-12 in sample mode, will significantly reduce the internal 130MHz input bandwidth and may increase the required acquisition time beyond the minimum acquisition time ( $t_{\text{ACQ-MIN}}$ ) of 153ns.

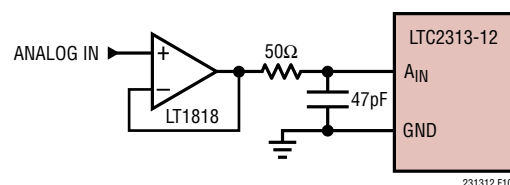

Figure 10. RC Input Filter

### ADC Reference

A low noise, low temperature drift reference is critical to achieving the full data sheet performance of the ADC. The LTC2313-12 provides an excellent internal reference with a guaranteed 20ppm/ $^{\circ}\text{C}$  maximum temperature coefficient. For added flexibility, an external reference may also be used.

The high speed, low noise internal reference buffer is used only in the internal reference configuration. The reference

231312fb

## APPLICATIONS INFORMATION

buffer must be overdriven in the external reference configuration with a voltage 50mV higher than the nominal reference output voltage in the internal configuration.

### Using the Internal Reference

The internal bandgap and reference buffer are active by default when the LTC2313-12 is not in sleep mode. The reference voltage at the REF pin scales automatically with the supply voltage at the  $V_{DD}$  pin. The scaling of the reference voltage with supply is shown in Table 2.

**Table 2. Reference Voltage vs Supply Range**

SUPPLY VOLTAGE ( $V_{DD}$ )	REF VOLTAGE ( $V_{REF}$ )
$2.7V < V_{DD} < 3.6V$	2.048V
$4.75V < V_{DD} < 5.25V$	4.096V

The reference voltage also determines the full-scale analog input range of the LTC2313-12. For example, a 2.048V reference voltage will accommodate an analog input range from 0V to 2.048V. An analog input voltage that goes below 0V will be coded as all zeros and an analog input voltage that exceeds 2.048V will be coded as all ones.

It is recommended that the REF pin be bypassed to ground with a low ESR, 2.2 $\mu$ F ceramic chip capacitor for optimum performance.

### External Reference

An external reference can be used with the LTC2313-12 if better performance is required or to accommodate a larger input voltage span. The only constraints are that the external reference voltage must be 50mV higher than

the internal reference voltage (see Table 2) and must be less than or equal to the supply voltage (or 4.3V for the 5V supply range). For example, a 3.3V external reference may be used with a 3.3V  $V_{DD}$  supply voltage to provide a 3.3V analog input voltage span (i.e.  $3.3V > 2.048V + 50mV$ ). Or alternatively, a 2.5V reference may be used with a 3V supply voltage to provide a 2.5V input voltage range (i.e.  $2.5V > 2.048V + 50mV$ ). The LTC6655-3.3, LTC6655-2.5, available from Linear Technology, may be suitable for many applications requiring a high performance external reference for either 3.3V or 2.5V input spans respectively.

### Transfer Function

Figure 11 depicts the transfer function of the LTC2313-12. The code transitions occur midway between successive integer LSB values (i.e. 0.5LSB, 1.5LSB, 2.5LSB... FS-0.5LSB). The output code is straight binary with 1LSB =  $V_{REF}/4096$ .

### DC Performance

The noise of an ADC can be evaluated in two ways: signal-to-noise ratio (SNR) in the frequency domain and histogram in the time domain. The LTC2313-12 excels in both. The noise in the time domain histogram is the transition noise associated with a 12-bit resolution ADC which can be measured with a fixed DC signal applied to the input of the ADC. The resulting output codes are collected over a large number of conversions. The shape of the distribution of codes will give an indication of the magnitude of the transition noise. In Figure 12, the distribution of output codes is shown for a DC input that has been digitized

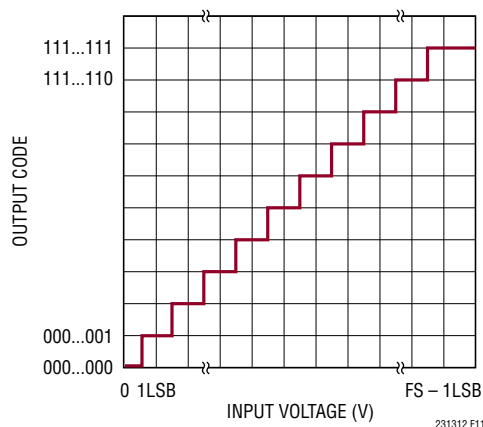

**Figure 11. LTC2313-12 Transfer Function**

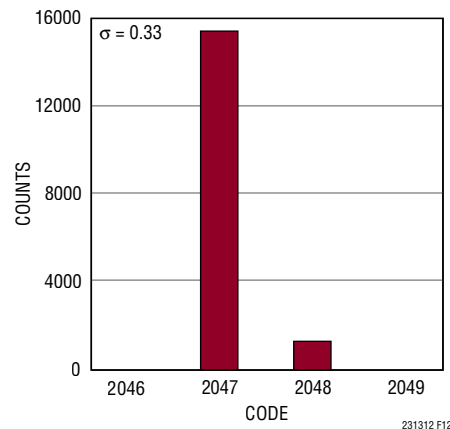

**Figure 12. Histogram for 16384 Conversions**



## APPLICATIONS INFORMATION

16,384 times. The distribution is Gaussian and the RMS code transition noise is 0.33LSB. This corresponds to a noise level of 73dB relative to a full scale voltage of 4.096V.

### Dynamic Performance

The LTC2313-12 has excellent high speed sampling capability. Fast Fourier Transform (FFT) techniques are used to test the ADC's frequency response, distortion and noise at the rated throughput. By applying a low distortion sine wave and analyzing the digital output using an FFT algorithm, the ADC's spectral content can be examined for frequencies outside the applied fundamental. The LTC2313-12 provides guaranteed tested limits for both AC distortion and noise measurements.

### Signal-to-Noise and Distortion Ratio (SINAD)

The signal-to-noise and distortion ratio (SINAD) is the ratio between the RMS amplitude of the fundamental input frequency and the RMS amplitude of all other frequency components at the A/D output. The output is band-limited to frequencies from above DC and below half the sampling frequency. Figure 14 shows the LTC2313-12 maintains a SINAD above 72dB up to an input frequency of 1MHz.

### Effective Number of Bits (ENOB)

The effective number of bits (ENOB) is a measurement of the resolution of an ADC and is directly related to SINAD by the equation where ENOB is the effective number of bits of resolution and SINAD is expressed in dB:

$$\text{ENOB} = (\text{SINAD} - 1.76)/6.02$$

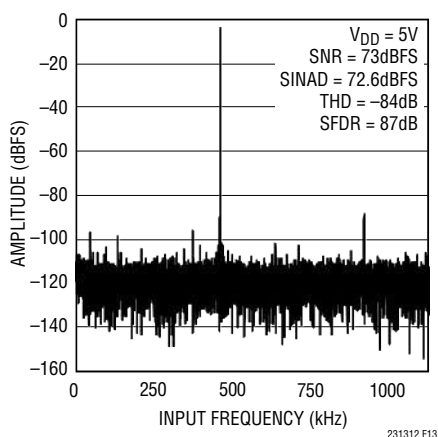

Figure 13. 16k Point FFT of the LTC2313-12 at  $f_{IN} = 497\text{kHz}$

At the maximum sampling rate of 2.5MHz, the LTC2313-12 maintains an ENOB above 11.7 bits up to an input frequency of 1MHz. (Figure 14)

### Signal-to-Noise Ratio (SNR)

The signal-to-noise ratio (SNR) is the ratio between the RMS amplitude of the fundamental input frequency and the RMS amplitude of all other frequency components except the first five harmonics and DC. Figure 13 shows that the LTC2313-12 achieves a typical SNR of 73dB at a 2.5MHz sampling rate with a 497kHz input frequency.

### Total Harmonic Distortion (THD)

Total Harmonic Distortion (THD) is the ratio of the RMS sum of all harmonics of the input signal to the fundamental itself. The out-of-band harmonics alias into the frequency band between DC and half the sampling frequency ( $f_{SAMPL}/2$ ). THD is expressed as:

$$\text{THD} = 20 \log \frac{\sqrt{V_2^2 + V_3^2 + V_4^2 + V_N^2}}{V_1}$$

where  $V_1$  is the RMS amplitude of the fundamental frequency and  $V_2$  through  $V_N$  are the amplitudes of the second through Nth harmonics. THD versus Input Frequency is shown in the Typical Performance Characteristics section. The LTC2313-12 has excellent distortion performance up to the Nyquist frequency.

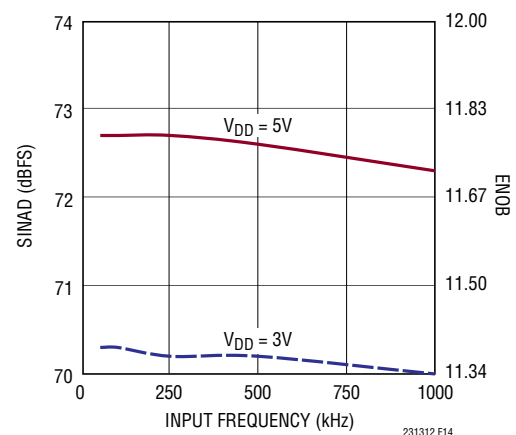

Figure 14. LTC2313-12 ENOB/SINAD vs  $f_{IN}$

## APPLICATIONS INFORMATION

### Intermodulation Distortion (IMD)

If the ADC input signal consists of more than one spectral component, the ADC transfer function nonlinearity can produce intermodulation distortion (IMD) in addition to THD. IMD is the change in one sinusoidal input caused by the presence of another sinusoidal input at a different frequency.

If two pure sine waves of frequencies  $f_a$  and  $f_b$  are applied to the ADC input, nonlinearities in the ADC transfer function can create distortion products at the sum and difference frequencies  $m \cdot f_a \pm n \cdot f_b$ , where  $m$  and  $n = 0, 1, 2, 3$ , etc. For example, the 2nd order IMD terms include  $(f_a \pm f_b)$ . If the two input sine waves are equal in magnitude, the value (in decibels) of the 2nd order IMD products can be expressed by the following formula:

$$\text{IMD}(f_a \pm f_b) = 20 \cdot \log[V_A(f_a \pm f_b)/V_A(f_a)]$$

The LTC2313-12 has excellent IMD, as shown in Figure 15.

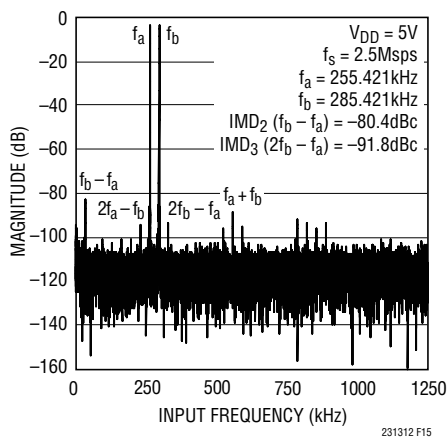

Figure 15. LTC2313-12 IMD Plot

### Spurious Free Dynamic Range (SFDR)

The spurious free dynamic range is the largest spectral component excluding DC and the input signal. This value is expressed in decibels relative to the RMS value of a full-scale input signal.

### Full-Power and -3dB Input Linear Bandwidth

The full-power bandwidth is the input frequency at which the amplitude of the reconstructed fundamental is reduced by 3dB for a full-scale input signal.

The -3dB linear bandwidth is the input frequency at which the SINAD has dropped to 68dB (11 effective bits). The LTC2313-12 has been designed to optimize the input bandwidth, allowing the ADC to under-sample input signals with frequencies above the converter's Nyquist frequency. The noise floor stays very low at high frequencies and SINAD becomes dominated by distortion at frequencies beyond Nyquist.

### Recommended Layout

To obtain the best performance from the LTC2313-12 a printed circuit board is required. Layout for the printed circuit board (PCB) should ensure the digital and analog signal lines are separated as much as possible. In particular, care should be taken not to run any digital clocks or signals alongside analog signals or underneath the ADC. Figures 16 through 20 are an example of a recommended PCB layout. A single solid ground plane is used. Bypass capacitors to the supplies are placed as close as possible to the supply pins. Low impedance common returns for these bypass capacitors are essential to the low noise operation of the ADC. The analog input traces are screened by ground. For more details and information refer to DC1563, the evaluation kit for the LTC2313-12.

### Bypassing Considerations

High quality ceramic bypass capacitors should be used at the  $V_{DD}$ ,  $OV_{DD}$  and REF pins. For optimum performance, a 2.2 $\mu$ F ceramic chip capacitor should be used for the  $V_{DD}$  and  $OV_{DD}$  pins. The recommended bypassing for the REF pin is also a low ESR, 2.2 $\mu$ F ceramic chip capacitor. The traces connecting the pins and the bypass capacitors must be kept as short as possible and should be made as wide as possible avoiding the use of vias.

All analog circuitry grounds should be terminated at the LTC2313-12. The ground return from the LTC2313-12 to the power supply should be low impedance for noise free operation. Digital circuitry grounds must be connected to the digital supply common.

231312fb



## APPLICATIONS INFORMATION

In applications where the ADC data outputs and control signals are connected to a continuously active microprocessor bus, it is possible to get errors in the conversion results. These errors are due to feed-through from the

microprocessor to the successive approximation comparator. The problem can be eliminated by forcing the microprocessor into a “Wait” state during conversion or by using three-state buffers to isolate the ADC data bus.

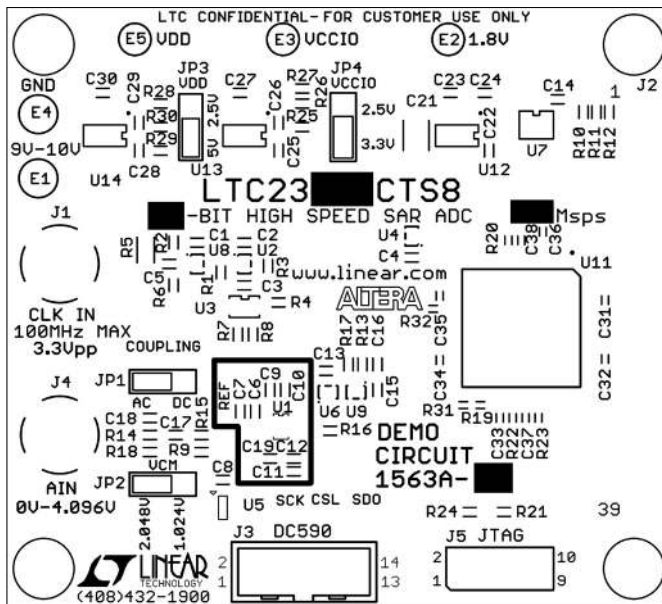

Figure 16. Top Silkscreen

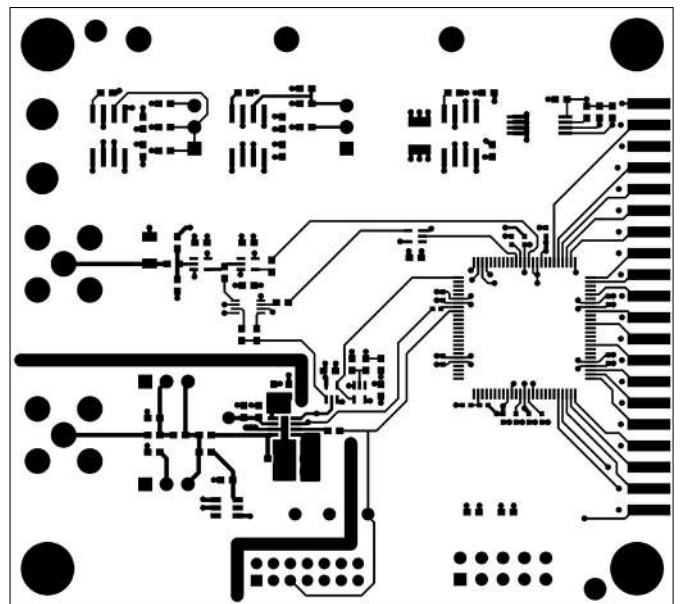

Figure 17. Layer 1 Top Layer

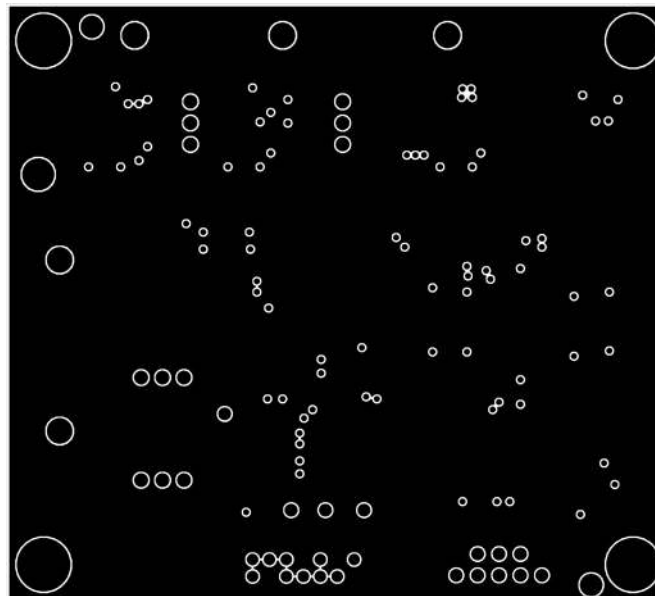

Figure 18. Layer 2 GND Plane

**APPLICATIONS INFORMATION**

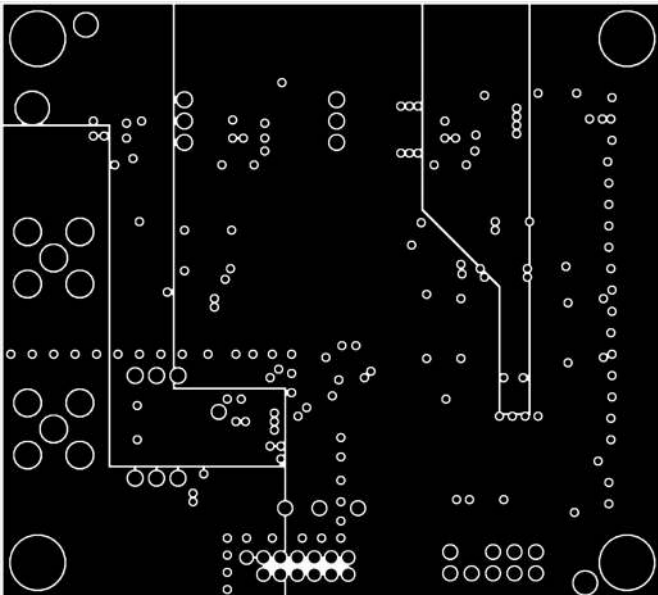

Figure 19. Layer 3 PWR Plane

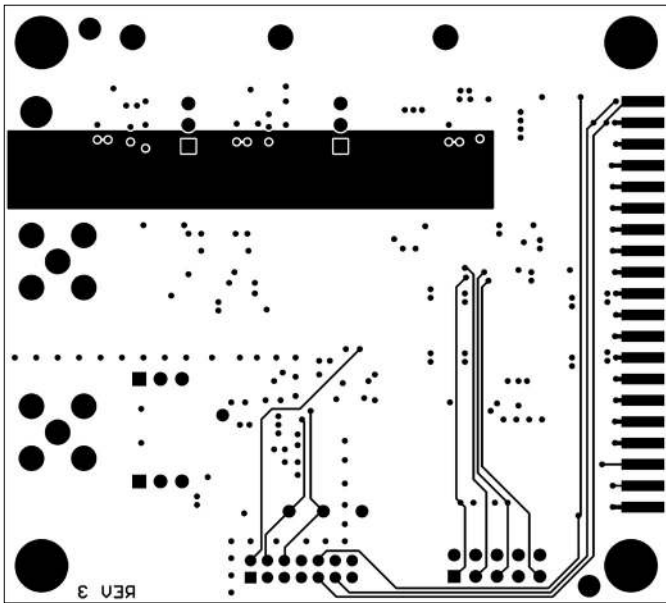
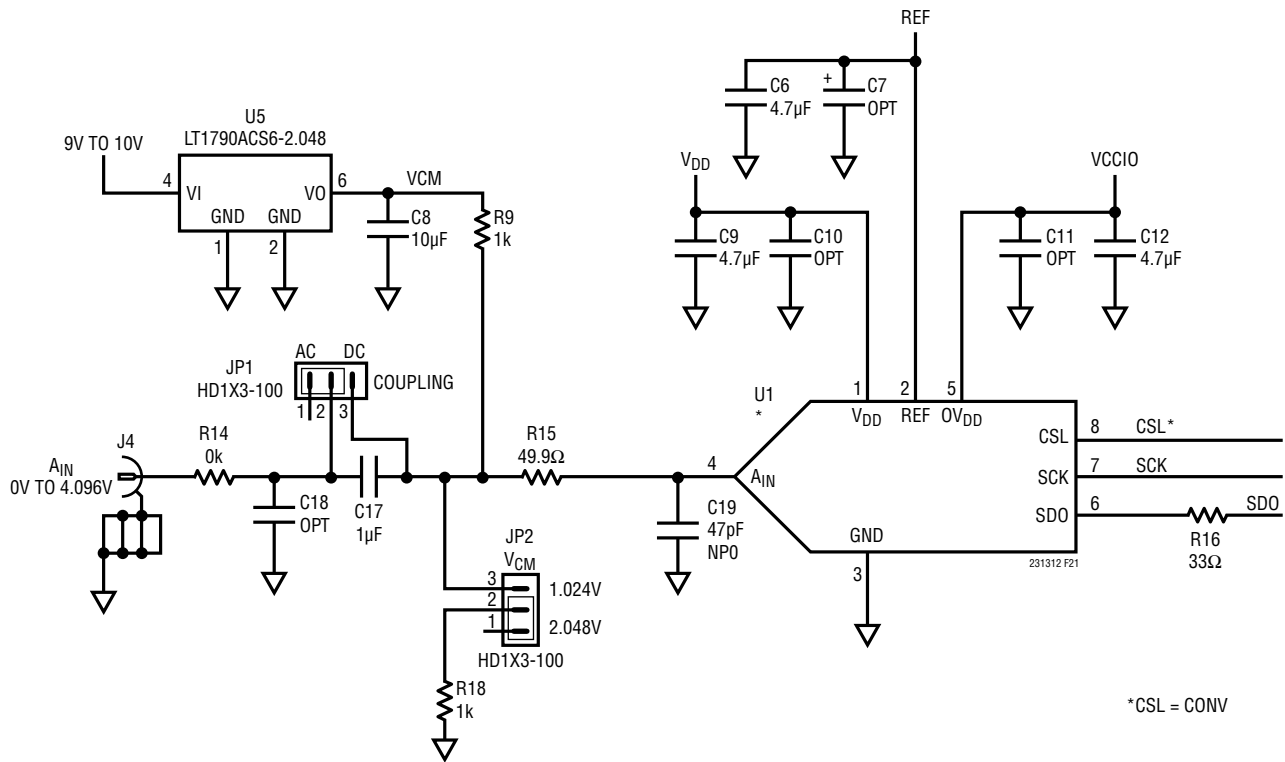

Figure 20. Layer 4 Bottom Layer

APPLICATIONS INFORMATION



\*CSL = CONV

Figure 21. Partial 1563 Demo Board Schematic

## PACKAGE DESCRIPTION

Please refer to <http://www.linear.com/designtools/packaging/> for the most recent package drawings.

### TS8 Package 8-Lead Plastic TSOT-23 (Reference LTC DWG # 05-08-1637 Rev A)

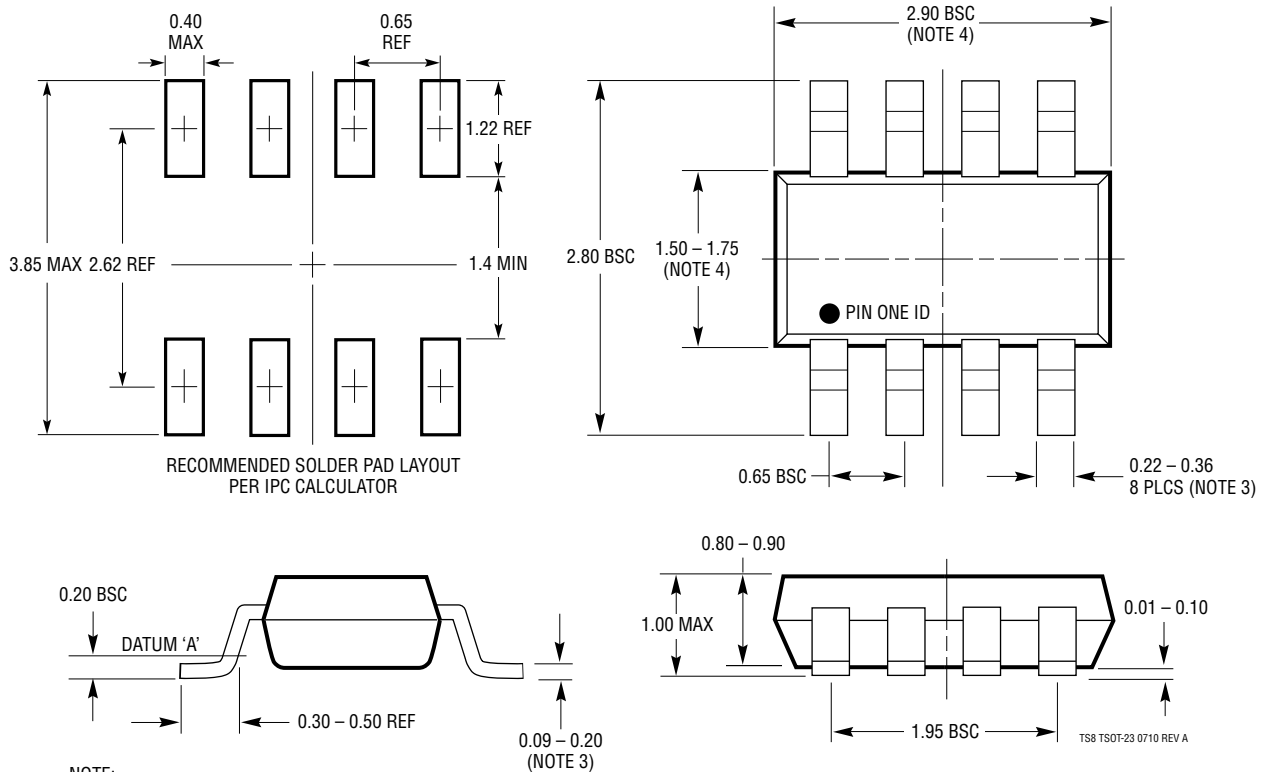

**NOTE:**

1. DIMENSIONS ARE IN MILLIMETERS
2. DRAWING NOT TO SCALE
3. DIMENSIONS ARE INCLUSIVE OF PLATING
4. DIMENSIONS ARE EXCLUSIVE OF MOLD FLASH AND METAL BURR
5. MOLD FLASH SHALL NOT EXCEED 0.254mm
6. JEDEC PACKAGE REFERENCE IS MO-193

TS8 TSOT-23 0710 REV A

## REVISION HISTORY

REV	DATE	DESCRIPTION	PAGE NUMBER
A	11/13	Added pin-compatible family table Reordered/renumbered notes	1 3, 5
B	01/15	Updated Timing Diagrams (Figures 8 and 9)	12

