

THIS COPY IS PROVIDED ON A RESTRICTED BASIS AND IS NOT TO BE USED IN ANY WAY DETRIMENTAL TO THE INTERESTS OF PANDUIT CORP.

Material	High Conductivity Seamless Copper Tube
Plating	Electro-Tin
Wire Size	2 STR/FLEX
Wire Type	Stranded Copper: Class B & C Compact, Class G, H, I, K, M, Locomotive
Wire Strip Length	1-7/16 in.
Stud Size	1/4 in.
UL Listed Wire Connector	Yes, for applications up to 35kv. Consult cable manufacturer for voltage stress relief instructions with applications greater than 2000 volts.
UL Temperature Rating	90° C
C.S.A Certified Wire Connector	Yes
Panduit Color Code on Barrel	BROWN
Panduit Die Index No. on Barrel	P33
Alternate Industry Die Index No. () on Barrel	(10)



CERTIFIED



LISTED Wire Connector

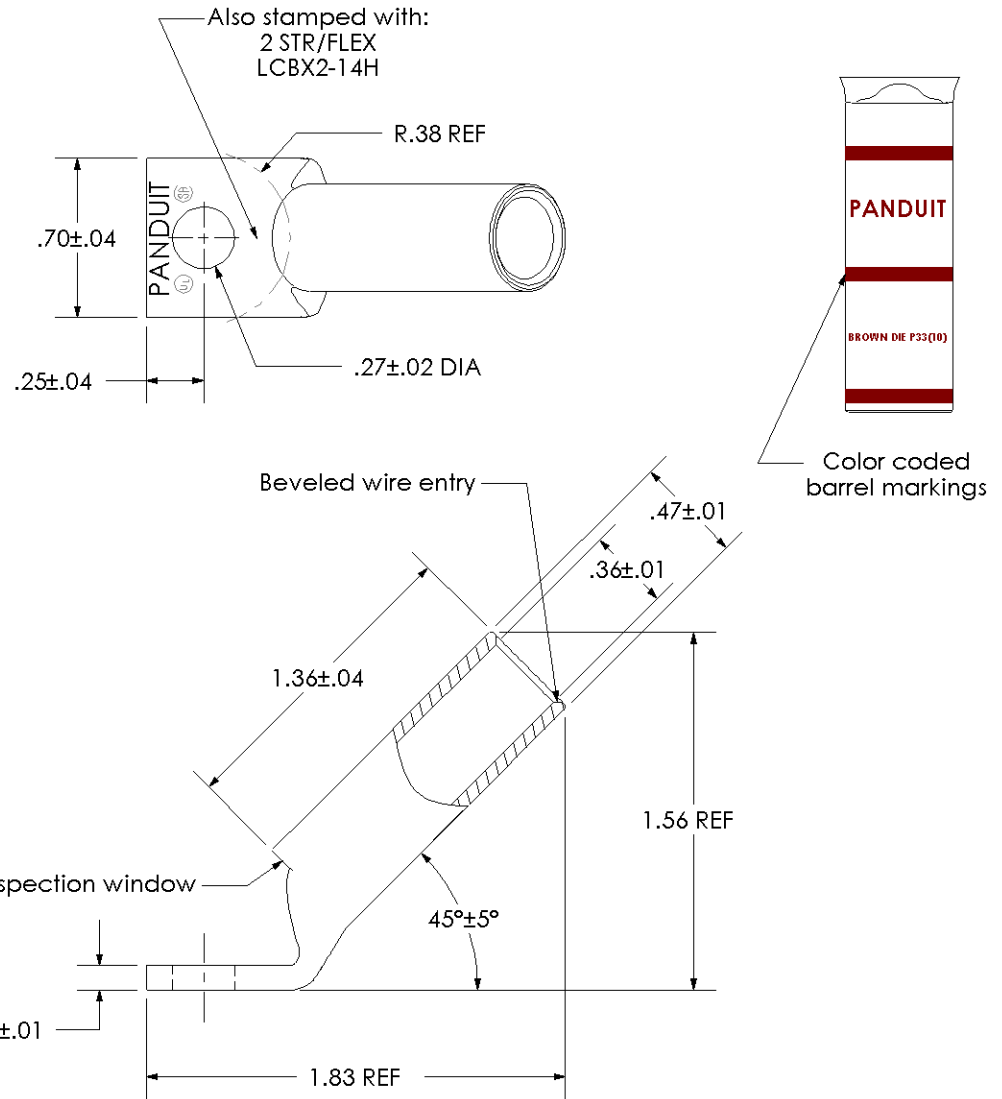

PANDUIT CORP. TINLEY PARK, ILLINOIS

LCBX2-14H-E
Copper Lug - One-Hole, Long Flex Barrel, 45° Angle Tongue

00 6/03 SAC SAC

RELEASED

10850

REV DATE BY CHK

DESCRIPTION

ECN

SCALE N/A

DRAWING NO / CAD FILE

LCBX2-14H-CUST