

# IR series

Sealed pushbutton switches • bushing  $\varnothing$  16 mm • momentary • microswitch version



## DISTINCTIVE FEATURES

Microswitch technology up to 5 A

Tactile feedback

Sealed to IP67

Flat round actuator for optional marking



## ENVIRONMENTAL SPECIFICATIONS

- Front panel sealing : IP67 according to IEC 60529
- Salt spray : IEC 512-6, test 11f
- Operating temperature : -20 °C to +85 °C (-4 °F to +185 °F)



## GENERAL SPECIFICATIONS

- Panel thickness : 3 mm (.118) max.
- Total travel : 1.6 mm (.062)  $\pm$  0.3 mm
- Typical operating force : 4 N  $\pm$  2 N
- Mechanical life : 1,000,000 cycles
- Torque : 0.8 Nm max. applied to nut
- Soldering : 320 °C (608 °F) max. for 3 sec.



## ELECTRICAL SPECIFICATIONS

- Max. current/voltage rating with resistive load (microswitch) :  
5 A 250 VAC, 50,000 cycles (function 7)  
5 A 250 VAC, 25,000 cycles (function 8)
- Initial contact resistance : 100 m $\Omega$  max.
- Insulation resistance : 1 G $\Omega$  min. at 500 VDC
- Dielectric strength : 750 Vrms between terminals  
2,000 Vrms between terminals and frame

The company reserves the right to change specifications without notice.



# IR series

Sealed pushbutton switches • bushing Ø 16 mm • momentary • microswitch version

## MATERIALS

- Case : thermoplastic UL94-V0
- Actuator : polyamide 6/6
- Bushing/bezel : polyamide 6/6
- Contacts : silver

APEM products may be recycled at end-of-life for the re-claiming of valuable metal components.

## MOUNTING

### PANEL CUT-OUT

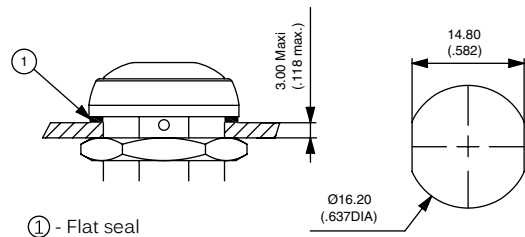

### MATRIX MOUNTING

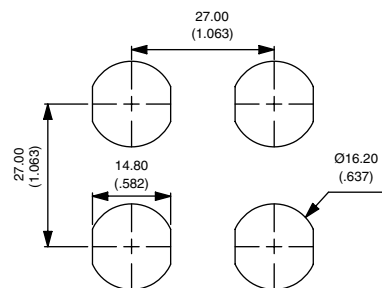

## TERMINALS

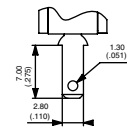

Quick-connect  
Function 7 (NC+NO))

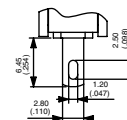

Solder lug  
Function 8 (NC/NO))

## ELECTRICAL FUNCTIONS

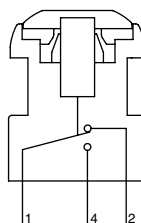

Function 7 (NC+NO))

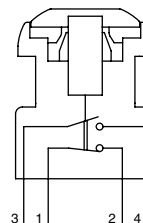

Function 8 (NC/NO))

# IR series

Sealed pushbutton switches • bushing Ø 16 mm • momentary • microswitch version



## BUILD YOUR PART NUMBER

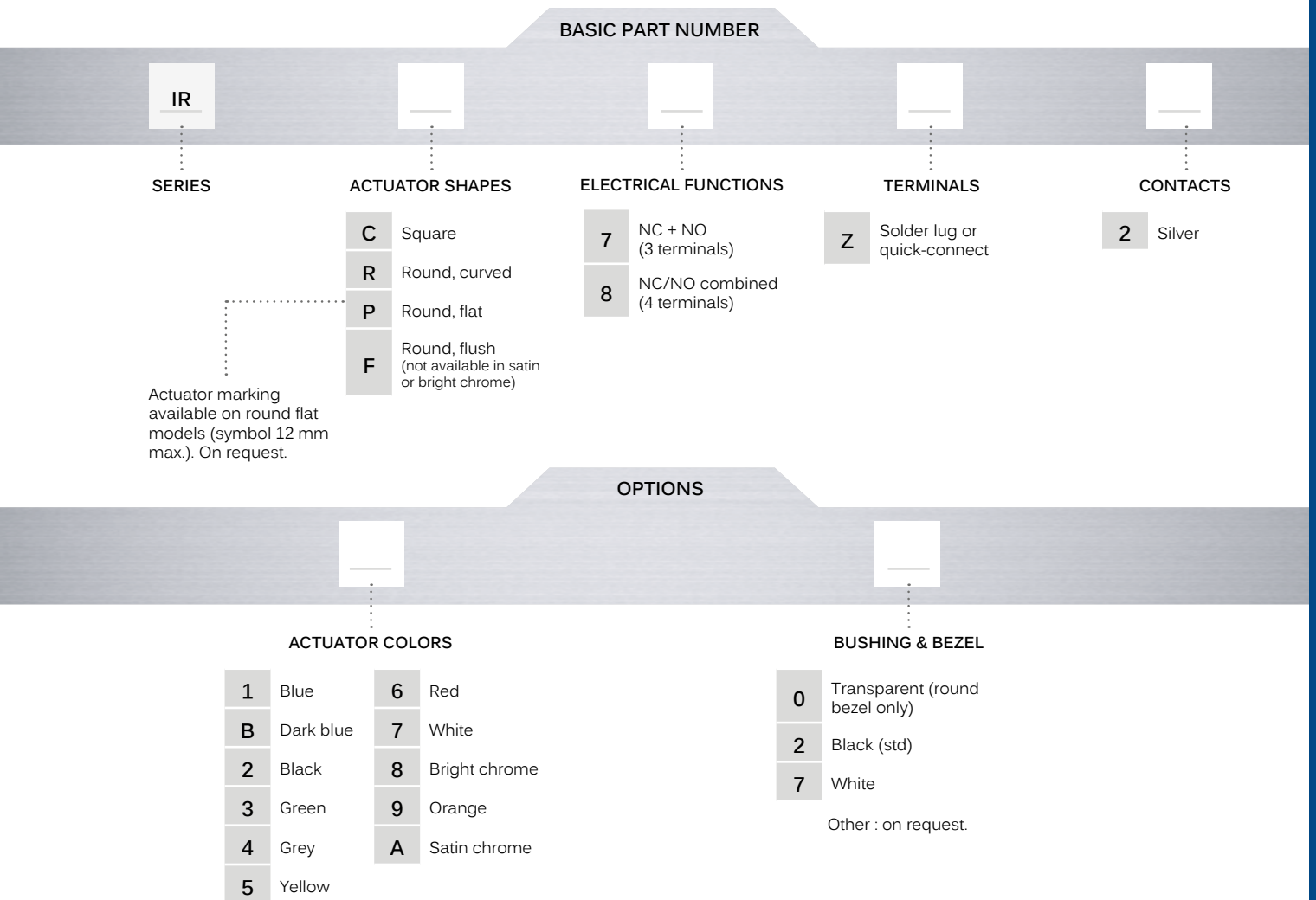

The IR series for high currents is based on a microswitch. Please note that this microswitch is supplied separately.



## ABOUT THIS SERIES

On the following pages, you will find successively basic part numbers of switches and options in the same order as in above chart.

- Notice** : please note that not all combinations of above numbers are available. Refer to the following pages for further information.
- A sealing boot** is available to protect the switches against frost and sand (P/N U7125). Round models only. See "Sealing Boots" section of website.
- Mounting accessories** : Standard hardware supplied : 1 hex nut 19 mm (.748) across flats and 1 flat seal. Hex nut P/N : U6715.

# IR series

Sealed pushbutton switches • bushing  $\varnothing$  16 mm • momentary • microswitch version

## ROUND - QUICK-CONNECT TERMINALS - NC+NO - 3 TERMINALS



Curved actuator  
**IRR7Z2**  NC+NO

Flat actuator  
**IRP7Z2**  NC+NO

## ROUND - SOLDER LUG TERMINALS - NC/NO - 4 TERMINALS



Curved actuator  
**IRR8Z2**  NC/NO combined

Flat actuator  
**IRP8Z2**  NC/NO combined

## SQUARE - QUICK-CONNECT TERMINALS - NC+NO - 3 TERMINALS



**IRC7Z2**  NC+NO

## SQUARE - SOLDER LUG TERMINALS - NC/NO - 4 TERMINALS



**IRC8Z2**  NC+NO

→ FLAT

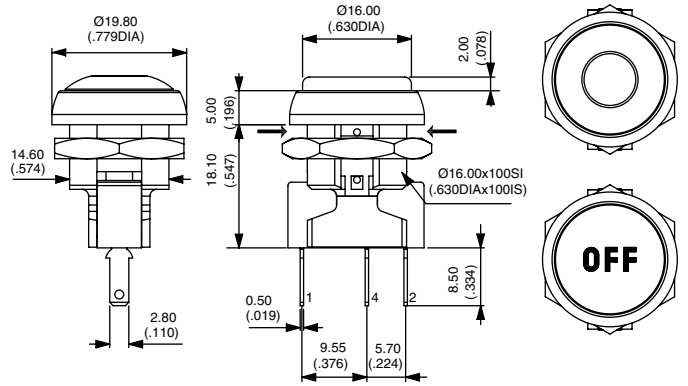

→ FLAT

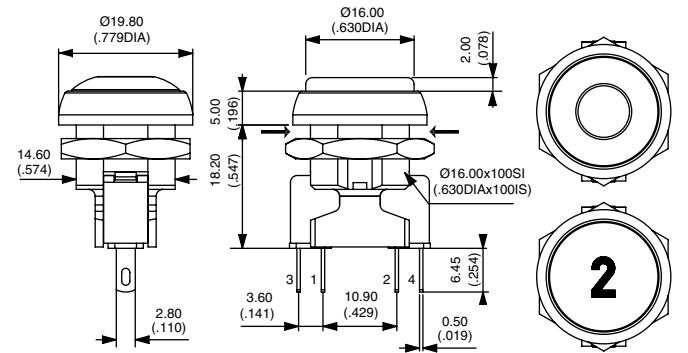

→ FLAT

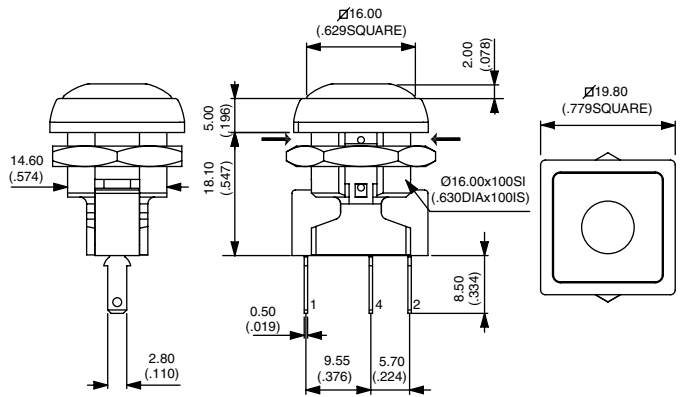

→ FLAT

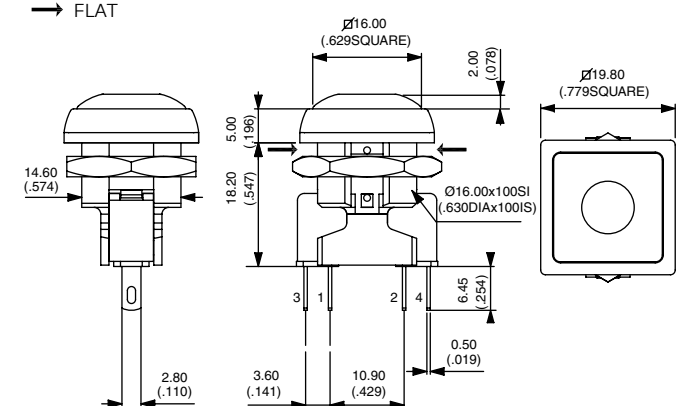

Terminals should be used as solder lugs only.

# IR series

Sealed pushbutton switches • bushing Ø 16 mm •  
momentary • microswitch version

## ACTUATOR COLORS

BASIC P/N



- 1 Blue
- B Dark blue
- 2 Black
- 3 Green
- 4 Grey
- 5 Yellow
- 6 Red
- 7 White
- 8 Bright chrome\*
- 9 Orange
- A Satin chrome\*

\* Non available with Round, flush actuator shape (F)

## BUSHING AND BEZEL

BASIC P/N



- 0 Transparent (round bezel only)
- 2 Black (standard)
- 7 White