

PLC-RPT- 24UC/21HC - Relay Module



2900293

<https://www.phoenixcontact.com/us/products/2900293>

Please be informed that the data shown in this PDF document is generated from our online catalog. Please find the complete data in the user documentation. Our general terms of use for downloads are valid.



PLC-INTERFACE for high continuous currents, consisting of PLC-BPT.../21 HC basic terminal block with Push-in connection and plug-in miniature relay, for mounting on DIN rail NS 35/7,5, limiting continuous current up to 10 A, 1 changeover contact, input voltage 24 V AC/DC

Your advantages

- Efficient connection to system cabling using V8 adapter
- All common input voltages of 12 V DC ... 230 V AC
- Long electrical service life thanks to 16 A relay
- Safe isolation according to DIN EN 50178 between coil and contact
- Functional plug-in bridges
- Max. continuous current of 10 A

Commercial data

| | |
|--------------------------------------|---------------------|
| Item number | 2900293 |
| Packing unit | 1 pc |
| Minimum order quantity | 10 pc |
| Sales key | C461 |
| Product key | CK623A |
| Catalog page | Page 384 (C-5-2019) |
| GTIN | 4046356509879 |
| Weight per piece (including packing) | 73.03 g |
| Weight per piece (excluding packing) | 64.88 g |
| Customs tariff number | 85364190 |
| Country of origin | DE |

Technical data

Product properties

| | |
|-------------------------|---------------------------|
| Product type | Relay Module |
| Product family | PLC-INTERFACE |
| Application | High continuous currents |
| Operating mode | 100% operating factor |
| Mechanical service life | 3x 10 ⁷ cycles |

Insulation characteristics

| | |
|------------|---------------------------------------|
| Insulation | Safe isolation, reinforced insulation |
|------------|---------------------------------------|

Insulation characteristics

| | |
|----------------------|---------------------------------------|
| Insulation | Safe isolation, reinforced insulation |
| Overvoltage category | III |
| Pollution degree | 3 |

Electrical properties

| | |
|---|--------|
| Maximum power dissipation for nominal condition | 0.42 W |
| Rated surge voltage | 6 kV |

Input data

Coil side

| | |
|---|---------------------------------------|
| Nominal input voltage U _N | 24 V AC/DC |
| Input voltage range | 20.6 V AC/DC ... 33.6 V AC/DC (20 °C) |
| Drive and function | monostable |
| Drive (polarity) | polarized |
| Typical input current at U _N | 17.5 mA |
| Typical response time | 8 ms |
| Typical release time | 10 ms |
| Protective circuit | Bridge rectifier; Bridge rectifier |
| Operating voltage display | Yellow LED |

Output data

Switching

| | |
|-----------------------------|---|
| Contact switching type | 1 changeover contact |
| Type of switch contact | Single contact |
| Contact material | AgNi |
| Maximum switching voltage | 250 V AC/DC (The separating plate PLC-ATP should be installed for voltages larger than 250 V (L1, L2, L3) between identical terminal blocks in adjacent modules. Potential bridging is then carried out with FBST 8-PLC... or ...FBST 500...) |
| Minimum switching voltage | 12 V (10 mA) |
| Limiting continuous current | 10 A |

PLC-RPT- 24UC/21HC - Relay Module



2900293

<https://www.phoenixcontact.com/us/products/2900293>

| | |
|---|---|
| | 6 A (value applies to connections 12. If connections 12 are bridged, the normal value applies.) |
| Maximum inrush current | 30 A (300 ms) |
| Min. switching current | 10 mA (12 V) |
| Interrupting rating (ohmic load) max. | 240 W (at 24 V DC) |
| | 58 W (at 48 V DC) |
| | 48 W (at 60 V DC) |
| | 50 W (at 110 V DC) |
| | 80 W (at 220 V DC) |
| | 2500 VA (for 250 V AC) |
| Interrupting rating (ohmic load) max. bridged | 144 W (for 24 V DC. Value applies to connections 12. If connections 12 are bridged, the normal value applies.) |
| | 1500 VA (for 250 V AC. Value applies to connections 12. If connections 12 are bridged, the normal value applies.) |
| Switching capacity | 2 A (at 24 V, DC13) |
| | 0.2 A (at 110 V, DC13) |
| | 0.2 A (at 250 V, DC13) |
| | 6 A (at 24 V, AC15) |
| | 6 A (at 120 V, AC15) |
| | 6 A (at 250 V, AC15) |

Connection data

| | |
|----------------------------------|--|
| Connection method | Push-in connection |
| Stripping length | 10 mm |
| Conductor cross section rigid | 0.14 mm ² ... 2.5 mm ² |
| Conductor cross section flexible | 0.14 mm ² ... 2.5 mm ² |
| | 0.2 mm ² ... 2.5 mm ² (Single ferrule) |
| | 2x 0.5 mm ² ... 1 mm ² (TWIN ferrule) |
| Conductor cross section AWG | 26 ... 14 |

Dimensions

| | |
|--------|-------|
| Width | 14 mm |
| Height | 80 mm |
| Depth | 94 mm |

Material specifications

| | |
|--|--------------|
| Flammability rating according to UL 94 | V0 (Housing) |
|--|--------------|

Environmental and real-life conditions

Ambient conditions

| | |
|---|-------------------|
| Degree of protection (Relay) | RT II (Relay) |
| Degree of protection (Relay base) | IP20 (Relay base) |
| Ambient temperature (operation) | -40 °C ... 60 °C |
| Ambient temperature (storage/transport) | -40 °C ... 85 °C |

PLC-RPT- 24UC/21HC - Relay Module



2900293

<https://www.phoenixcontact.com/us/products/2900293>

Approvals

Corrosive gas test

| | |
|----------------|----------------------------|
| Identification | ISA-S71.04. G3 Harsh Group |
| | EN 60068-2-60 |

Standards and regulations

| | |
|-----------------------|---------------|
| Standards/regulations | IEC 60947-5-1 |
|-----------------------|---------------|

Mounting

| | |
|-----------------------|---------------------------|
| Mounting type | DIN rail mounting |
| Assembly instructions | in rows with zero spacing |
| Mounting position | any |

Drawings

Diagram

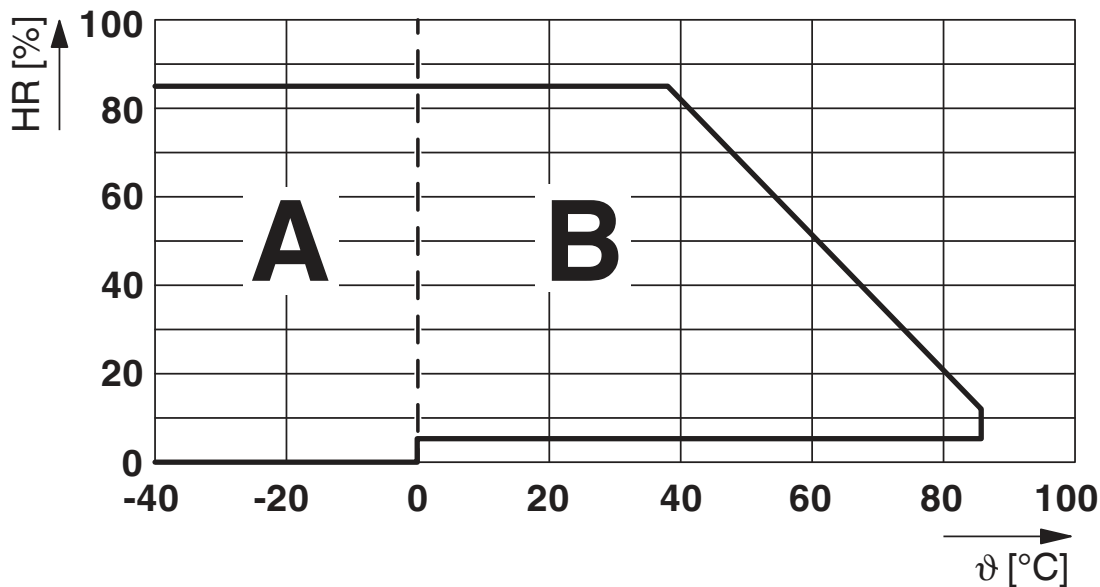

Permissible humidity for operation and storage.

The maximum permissible ambient temperature as specified in the data sheet must be observed.

Area A: Ice buildup at ambient temperatures $\leq 0^{\circ}\text{C}$ must be prevented

Area B: Condensation at ambient temperatures $> 0^{\circ}\text{C}$ must be prevented

On 30 full days that are naturally distributed across an entire year, a humidity level of 95% is permissible at an ambient temperature $\leq 25^{\circ}\text{C}$.

Circuit diagram

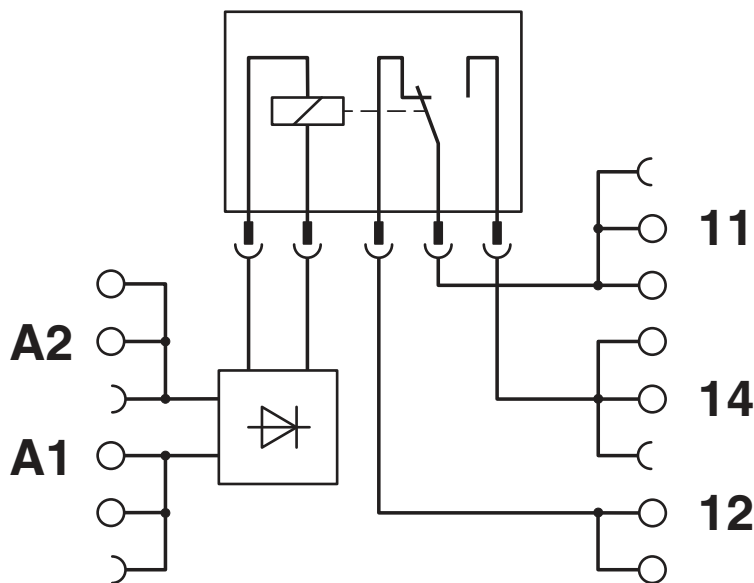

Diagram

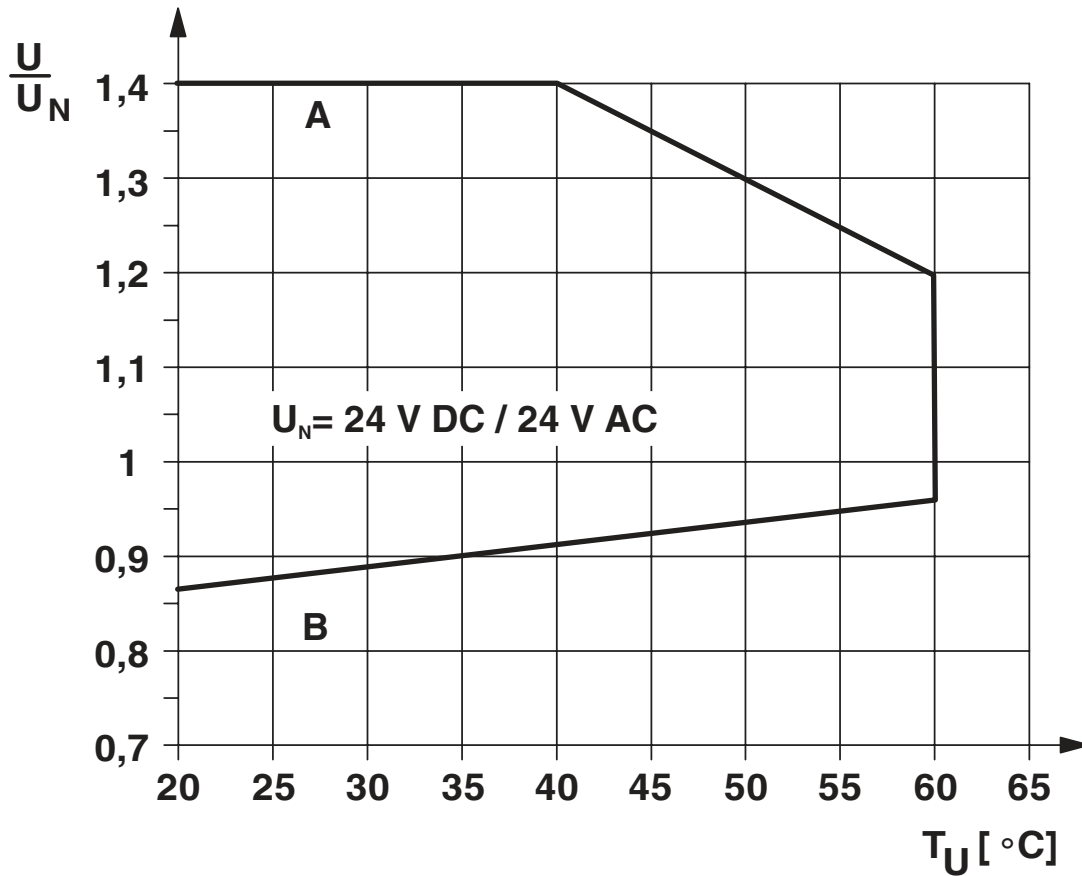

Curve A

Maximum permissible continuous voltage U_{max} with limiting continuous current on the contact side (see relevant technical data)

Curve B

Minimum permissible operate voltage U_{op} after pre-excitation (see relevant technical data)

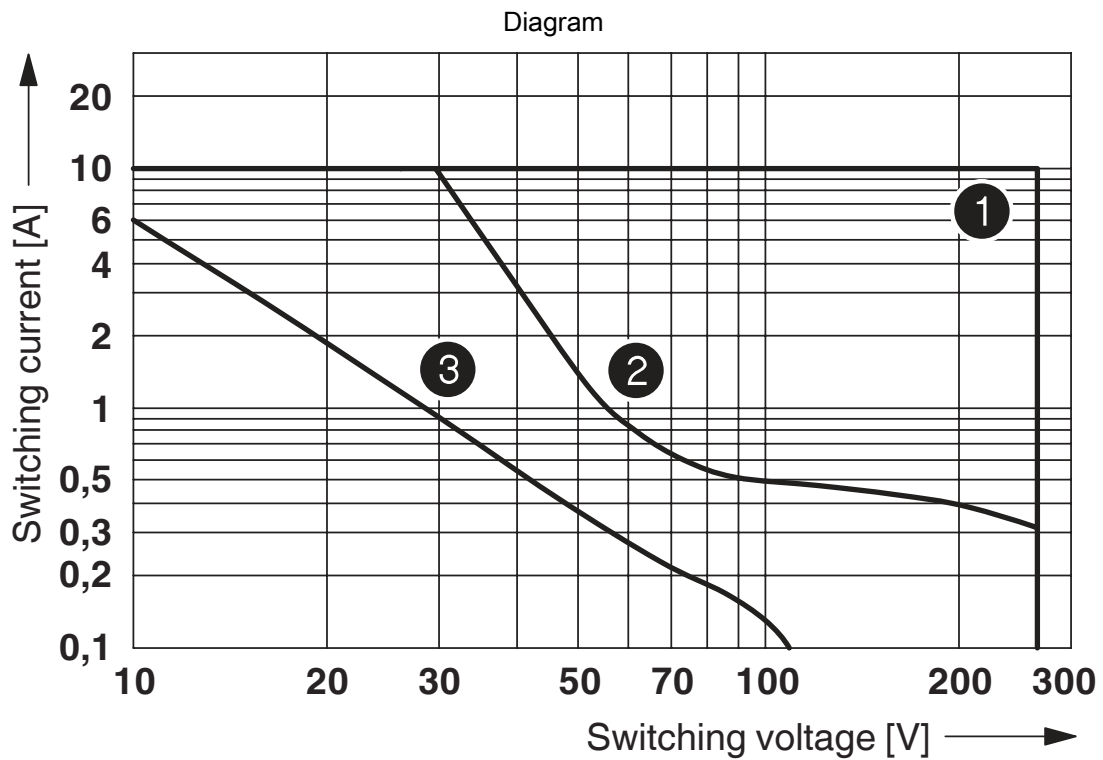

- ① AC, ohmic load
- ② DC, ohmic load
- ③ DC, L/R = 40 ms

Interrupting rating

PLC-RPT- 24UC/21HC - Relay Module



2900293

<https://www.phoenixcontact.com/us/products/2900293>

Approvals

To download certificates, visit the product detail page: <https://www.phoenixcontact.com/us/products/2900293>



cUL Recognized
Approval ID: FILE E 238705



UL Recognized
Approval ID: FILE E 238705



EAC
Approval ID: TR_TS_D_00573_c



DNV GL
Approval ID: TAE0000196



UL Listed
Approval ID: FILE E 172140



cUL Listed
Approval ID: FILE E 172140

cULus Recognized

cULus Listed

PLC-RPT- 24UC/21HC - Relay Module



2900293

<https://www.phoenixcontact.com/us/products/2900293>

Classifications

ECLASS

| | |
|-------------|----------|
| ECLASS-11.0 | 27371601 |
| ECLASS-12.0 | 27371601 |
| ECLASS-13.0 | 27371601 |

ETIM

| | |
|----------|----------|
| ETIM 8.0 | EC001437 |
|----------|----------|

UNSPSC

| | |
|-------------|----------|
| UNSPSC 21.0 | 39122300 |
|-------------|----------|

PLC-RPT- 24UC/21HC - Relay Module



2900293

<https://www.phoenixcontact.com/us/products/2900293>

Environmental product compliance

| | |
|------------|--|
| REACH SVHC | Lead 7439-92-1 |
| | Hexahydromethylphthalic anhydride |
| China RoHS | Environmentally Friendly Use Period = 50 years |
| | For information on hazardous substances, refer to the manufacturer's declaration available under "Downloads" |

PLC-RPT- 24UC/21HC - Relay Module

2900293

<https://www.phoenixcontact.com/us/products/2900293>

Accessories

 Note: Applying some accessories below might limit this product.

FBST 500-PLC RD - Continuous plug-in bridge

2966786

<https://www.phoenixcontact.com/us/products/2966786>



Continuous plug-in bridge, length: 500 mm, color: red

 Max. current carrying capacity: 32 A

FBST 500-PLC BU - Continuous plug-in bridge

2966692

<https://www.phoenixcontact.com/us/products/2966692>



Continuous plug-in bridge, length: 500 mm, color: blue

 Max. current carrying capacity: 32 A

PLC-RPT- 24UC/21HC - Relay Module

2900293

<https://www.phoenixcontact.com/us/products/2900293>



FBST 500-PLC GY - Continuous plug-in bridge

2966838

<https://www.phoenixcontact.com/us/products/2966838>



Continuous plug-in bridge, length: 500 mm, color: gray

 Max. current carrying capacity: 32 A

FBST 6-PLC RD - Single plug-in bridge

2966236

<https://www.phoenixcontact.com/us/products/2966236>



Single plug-in bridge, number of positions: 2, length: 6 mm, color: red

 Max. current carrying capacity: 6 A

PLC-RPT- 24UC/21HC - Relay Module

2900293

<https://www.phoenixcontact.com/us/products/2900293>

FBST 6-PLC BU - Single plug-in bridge

2966812

<https://www.phoenixcontact.com/us/products/2966812>

Single plug-in bridge, number of positions: 2, length: 6 mm, color: blue



 Max. current carrying capacity: 6 A

FBST 6-PLC GY - Single plug-in bridge

2966825

<https://www.phoenixcontact.com/us/products/2966825>

Single plug-in bridge, number of positions: 2, length: 6 mm, color: gray



 Max. current carrying capacity: 6 A

PLC-RPT- 24UC/21HC - Relay Module

2900293

<https://www.phoenixcontact.com/us/products/2900293>



FBST 8-PLC GY - Single plug-in bridge

2967688

<https://www.phoenixcontact.com/us/products/2967688>

Single plug-in bridge, number of positions: 2, length: 8 mm, color: gray



 Max. current carrying capacity: 6 A

FBST 14-PLC BK - Single plug-in bridge

2967691

<https://www.phoenixcontact.com/us/products/2967691>

Single plug-in bridge, number of positions: 2, length: 14 mm, color: black



 Max. current carrying capacity: 10 A

PLC-RPT- 24UC/21HC - Relay Module

2900293

<https://www.phoenixcontact.com/us/products/2900293>

ZB 10:UNBEDRUCKT - Zack marker strip

1053001

<https://www.phoenixcontact.com/us/products/1053001>



Zack marker strip, Strip, white, unlabeled, can be labeled with: PLOTMARK, CMS-P1-PLOTTER, mounting type: snapped, for terminal block width: 10.2 mm, lettering field size: 10.5 x 10.15 mm, Number of individual labels: 10

ZB 10 CUS - Zack marker strip

0824941

<https://www.phoenixcontact.com/us/products/0824941>



Zack marker strip, can be ordered: Strip, white, labeled according to customer specifications, mounting type: snap into tall marker groove, for terminal block width: 10.2 mm, lettering field size: 10,15 x 10,5 mm, Number of individual labels: 10

PLC-RPT- 24UC/21HC - Relay Module

2900293

<https://www.phoenixcontact.com/us/products/2900293>

ZB10,LGS:FORTL.ZAHLEN - Zack marker strip

1053014

<https://www.phoenixcontact.com/us/products/1053014>



Zack marker strip, Strip, white, labeled, can be labeled with: CMS-P1-PLOTTER, printed horizontally: consecutive numbers 1 ... 10, 11 ... 20, etc. up to 91 ... 100, mounting type: snapped, for terminal block width: 10.2 mm, lettering field size: 10,15 x 10,5 mm, Number of individual labels: 10

ZB10,QR:FORTL.ZAHLEN - Zack marker strip

1053027

<https://www.phoenixcontact.com/us/products/1053027>



Zack marker strip, Strip, white, labeled, can be labeled with: CMS-P1-PLOTTER, Printed vertically: consecutive numbers 1 ... 10, 11 ... 20, etc. up to 91 ... 100, mounting type: snapped, for terminal block width: 10.2 mm, lettering field size: 10,15 x 10,5 mm, Number of individual labels: 10

PLC-RPT- 24UC/21HC - Relay Module

2900293

<https://www.phoenixcontact.com/us/products/2900293>

ZB10,LGS:L1-N,PE - Marker for terminal blocks

1053412

<https://www.phoenixcontact.com/us/products/1053412>



Marker for terminal blocks, Strip, white, labeled, can be labeled with: CMS-P1-PLOTTER, horizontal: L1, L2, L3, N, PE, L1, L2, L3, N, PE, mounting type: snapped, for terminal block width: 10.2 mm, lettering field size: 10,15 x 10,5 mm, Number of individual labels: 10

ZB10,LGS:U-N - Marker for terminal blocks

1053438

<https://www.phoenixcontact.com/us/products/1053438>



Marker for terminal blocks, Strip, white, labeled, can be labeled with: CMS-P1-PLOTTER, horizontal: U, V, W, N, GND, U, V, W, N, GND, mounting type: snapped, for terminal block width: 10.2 mm, lettering field size: 10,15 x 10,5 mm, Number of individual labels: 10

PLC-RPT- 24UC/21HC - Relay Module



2900293

<https://www.phoenixcontact.com/us/products/2900293>

UC-TM 10 - Marker for terminal blocks

0818069

<https://www.phoenixcontact.com/us/products/0818069>



Marker for terminal blocks, Sheet, white, unlabeled, can be labeled with: BLUEMARK ID COLOR, BLUEMARK ID, BLUEMARK CLED, PLOTMARK, CMS-P1-PLOTTER, mounting type: snapped, for terminal block width: 10.2 mm, lettering field size: 9.6 x 10.5 mm, Number of individual labels: 48

UC-TM 10 CUS - Marker for terminal blocks

0824605

<https://www.phoenixcontact.com/us/products/0824605>



Marker for terminal blocks, can be ordered: by sheet, white, labeled according to customer specifications, mounting type: snap into tall marker groove, for terminal block width: 10.2 mm, lettering field size: 9.6 x 10.5 mm, Number of individual labels: 48

PLC-RPT- 24UC/21HC - Relay Module



2900293

<https://www.phoenixcontact.com/us/products/2900293>

UCT-TM 10 - Marker for terminal blocks

0829142

<https://www.phoenixcontact.com/us/products/0829142>



Marker for terminal blocks, Sheet, white, unlabeled, can be labeled with: TOPMARK NEO, TOPMARK LASER, BLUEMARK ID COLOR, BLUEMARK ID, BLUEMARK CLED, THERMOMARK PRIME, THERMOMARK CARD 2.0, THERMOMARK CARD, mounting type: snapped, for terminal block width: 10.2 mm, lettering field size: 8.9 x 9.6 mm, Number of individual labels: 36

UCT-TM 10 CUS - Marker for terminal blocks

0829623

<https://www.phoenixcontact.com/us/products/0829623>



Marker for terminal blocks, can be ordered: by sheet, white, labeled according to customer specifications, mounting type: snap into tall marker groove, for terminal block width: 10.2 mm, lettering field size: 8.9 x 9.6 mm, Number of individual labels: 36

PLC-RPT- 24UC/21HC - Relay Module



2900293

<https://www.phoenixcontact.com/us/products/2900293>

ZB 12:UNPRINTED - Zack marker strip

0812120

<https://www.phoenixcontact.com/us/products/0812120>



Zack marker strip, Strip, white, unlabeled, can be labeled with: PLOTMARK, CMS-P1-PLOTTER, mounting type: snapped, for terminal block width: 12.2 mm, lettering field size: 12 x 10.5 mm, Number of individual labels: 5

ZB 12 CUS - Zack marker strip

0824942

<https://www.phoenixcontact.com/us/products/0824942>



Zack marker strip, can be ordered: Strip, white, labeled according to customer specifications, mounting type: snap into tall marker groove, for terminal block width: 12.2 mm, lettering field size: 10.5 x 12.15 mm, Number of individual labels: 5

PLC-RPT- 24UC/21HC - Relay Module



2900293

<https://www.phoenixcontact.com/us/products/2900293>

ZB 12,LGS:L1-N,PE - Zack marker strip

0812146

<https://www.phoenixcontact.com/us/products/0812146>



Zack marker strip, Strip, white, labeled, printed horizontally: L1, L2, L3, N, PE, mounting type: snapped, for terminal block width: 12.2 mm, lettering field size: 10.5 x 12.15 mm, Number of individual labels: 5

UC-TM 12 - Marker for terminal blocks

0819194

<https://www.phoenixcontact.com/us/products/0819194>



Marker for terminal blocks, Sheet, white, unlabeled, can be labeled with: BLUEMARK ID COLOR, BLUEMARK ID, BLUEMARK CLED, PLOTMARK, CMS-P1-PLOTTER, mounting type: snapped, for terminal block width: 12 mm, lettering field size: 11.45 x 10.5 mm, Number of individual labels: 40

PLC-RPT- 24UC/21HC - Relay Module



2900293

<https://www.phoenixcontact.com/us/products/2900293>

UC-TM 12 CUS - Marker for terminal blocks

0824613

<https://www.phoenixcontact.com/us/products/0824613>



Marker for terminal blocks, can be ordered: by sheet, white, labeled according to customer specifications, mounting type: snap into tall marker groove, for terminal block width: 12 mm, lettering field size: 11.45 x 10.5 mm, Number of individual labels: 40

UCT-TM 12 - Marker for terminal blocks

0829144

<https://www.phoenixcontact.com/us/products/0829144>



Marker for terminal blocks, Sheet, white, unlabeled, can be labeled with: TOPMARK NEO, TOPMARK LASER, BLUEMARK ID COLOR, BLUEMARK ID, BLUEMARK CLED, THERMOMARK PRIME, THERMOMARK CARD 2.0, THERMOMARK CARD, mounting type: snapped, for terminal block width: 12 mm, lettering field size: 10.8 x 9.6 mm, Number of individual labels: 30

PLC-RPT- 24UC/21HC - Relay Module

2900293

<https://www.phoenixcontact.com/us/products/2900293>



UCT-TM 12 CUS - Marker for terminal blocks

0829630

<https://www.phoenixcontact.com/us/products/0829630>



Marker for terminal blocks, can be ordered: by sheet, white, labeled according to customer specifications, mounting type: snap into tall marker groove, for terminal block width: 12 mm, lettering field size: 10.8 x 9.6 mm, Number of individual labels: 30

NS 35/ 7,5 PERF 2000MM - DIN rail perforated

0801733

<https://www.phoenixcontact.com/us/products/0801733>



DIN rail perforated, acc. to EN 60715, material: Steel, galvanized, passivated with a thick layer, Standard profile, color: silver, Pack of 25 (50 m)

PLC-RPT- 24UC/21HC - Relay Module



2900293

<https://www.phoenixcontact.com/us/products/2900293>

NS 35/ 7,5 UNPERF 2000MM - DIN rail, unperforated

0801681

<https://www.phoenixcontact.com/us/products/0801681>



DIN rail, unperforated, acc. to EN 60715, material: Steel, galvanized, passivated with a thick layer, Standard profile, color: silver, Pack of 25 (50 m)

NS 35/ 7,5 WH PERF 2000MM - DIN rail perforated

1204119

<https://www.phoenixcontact.com/us/products/1204119>



DIN rail perforated, acc. to EN 60715, material: Steel, Galvanized, white passivated, Standard profile, color: silver, Pack of 25 (50 m)

PLC-RPT- 24UC/21HC - Relay Module

2900293

<https://www.phoenixcontact.com/us/products/2900293>



NS 35/ 7,5 WH UNPERF 2000MM-VPE 10 - DIN rail, unperforated

1204122

<https://www.phoenixcontact.com/us/products/1204122>



DIN rail, unperforated, acc. to EN 60715, material: Steel, Galvanized, white passivated, Standard profile, color: silver, Pack of 10 (20 m)

NS 35/ 7,5 AL UNPERF 2000MM - DIN rail, unperforated

0801704

<https://www.phoenixcontact.com/us/products/0801704>



DIN rail, unperforated, acc. to EN 60715, material: Aluminum, uncoated, Standard profile, color: silver, Pack of 25 (50 m)

PLC-RPT- 24UC/21HC - Relay Module

2900293

<https://www.phoenixcontact.com/us/products/2900293>

NS 35/ 7,5 ZN PERF 2000MM - DIN rail perforated

1206421

<https://www.phoenixcontact.com/us/products/1206421>



DIN rail perforated, acc. to EN 60715, material: Steel, galvanized, Standard profile, color: silver, Pack of 25 (50 m)

NS 35/ 7,5 ZN UNPERF 2000MM - DIN rail, unperforated

1206434

<https://www.phoenixcontact.com/us/products/1206434>



DIN rail, unperforated, acc. to EN 60715, material: Steel, galvanized, Standard profile, color: silver, Pack of 25 (50 m)

PLC-RPT- 24UC/21HC - Relay Module



2900293

<https://www.phoenixcontact.com/us/products/2900293>

NS 35/ 7,5 CU UNPERF 2000MM-VPE 10 - DIN rail, unperforated

0801762

<https://www.phoenixcontact.com/us/products/0801762>



DIN rail, unperforated, acc. to EN 60715, material: Copper, uncoated, Standard profile, color: copper-colored, Pack of 10 (20 m)

NS 35/ 7,5 CAP - End cap

1206560

<https://www.phoenixcontact.com/us/products/1206560>

DIN rail end piece, for DIN rail NS 35/7.5



PLC-RPT- 24UC/21HC - Relay Module



2900293

<https://www.phoenixcontact.com/us/products/2900293>

NS 35/15 PERF 2000MM - DIN rail perforated

1201730

<https://www.phoenixcontact.com/us/products/1201730>



DIN rail perforated, similar to EN 60715, material: Steel, galvanized, passivated with a thick layer, Standard profile, color: silver, Pack of 25 (50 m)

NS 35/15 UNPERF 2000MM - DIN rail, unperforated

1201714

<https://www.phoenixcontact.com/us/products/1201714>



DIN rail, unperforated, similar to EN 60715, material: Steel, galvanized, passivated with a thick layer, Standard profile, color: silver, Pack of 25 (50 m)

PLC-RPT- 24UC/21HC - Relay Module

2900293

<https://www.phoenixcontact.com/us/products/2900293>

NS 35/15 WH PERF 2000MM - DIN rail perforated

0806602

<https://www.phoenixcontact.com/us/products/0806602>



DIN rail perforated, similar to EN 60715, material: Steel, Galvanized, white passivated, Standard profile, color: white, Pack of 25 (50 m)

NS 35/15 WH UNPERF 2000MM-VPE 10 - DIN rail, unperforated

1204135

<https://www.phoenixcontact.com/us/products/1204135>



DIN rail, unperforated, similar to EN 60715, material: Steel, Galvanized, white passivated, Standard profile, color: silver, Pack of 10 (20 m)

PLC-RPT- 24UC/21HC - Relay Module



2900293

<https://www.phoenixcontact.com/us/products/2900293>

NS 35/15 AL UNPERF 2000MM - DIN rail, unperforated

1201756

<https://www.phoenixcontact.com/us/products/1201756>



DIN rail, unperforated, similar to EN 60715, material: Aluminum, uncoated, Standard profile, color: silver

NS 35/15 ZN PERF 2000MM - DIN rail perforated

1206599

<https://www.phoenixcontact.com/us/products/1206599>



DIN rail perforated, similar to EN 60715, material: Steel, galvanized, Standard profile, color: silver, Pack of 25 (50 m)

PLC-RPT- 24UC/21HC - Relay Module

2900293

<https://www.phoenixcontact.com/us/products/2900293>

NS 35/15 ZN UNPERF 2000MM - DIN rail, unperforated

1206586

<https://www.phoenixcontact.com/us/products/1206586>



DIN rail, unperforated, similar to EN 60715, material: Steel, galvanized, Standard profile, color: silver, Pack of 25 (50 m)

NS 35/15 CU UNPERF 2000MM-VPE 10 - DIN rail, unperforated

1201895

<https://www.phoenixcontact.com/us/products/1201895>



DIN rail, unperforated, similar to EN 60715, material: Copper, uncoated, Standard profile, color: copper-colored, Pack of 10 (20 m)

PLC-RPT- 24UC/21HC - Relay Module



2900293

<https://www.phoenixcontact.com/us/products/2900293>

NS 35/15 CAP - End cap

1206573

<https://www.phoenixcontact.com/us/products/1206573>

DIN rail end piece, for DIN rail NS 35/15



NS 35/15-2,3 UNPERF 2000MM-VPE 10 - DIN rail, unperforated

1201798

<https://www.phoenixcontact.com/us/products/1201798>

DIN rail, unperforated, acc. to EN 60715, material: Steel, galvanized, passivated with a thick layer, Standard profile 2.3 mm, color: silver, Pack of 10 (20 m)



PLC-RPT- 24UC/21HC - Relay Module

2900293

<https://www.phoenixcontact.com/us/products/2900293>

PLC-ATP BK - Separating plate

2966841

<https://www.phoenixcontact.com/us/products/2966841>



Separating plate, 2 mm thick, required at the start and end of a PLC terminal strip. Furthermore, it is used for: visual separation of groups, safe isolation of different voltages of neighboring PLC relays in acc. with DIN VDE 0106-101, isolation

PLC-ESK GY - Power terminal block

2966508

<https://www.phoenixcontact.com/us/products/2966508>



Power terminal block, for the input of up to four potentials, for mounting on NS 35/7.5

PLC-RPT- 24UC/21HC - Relay Module

2900293

<https://www.phoenixcontact.com/us/products/2900293>



SZF 1-0,6X3,5 - Screwdriver

1204517

<https://www.phoenixcontact.com/us/products/1204517>



Actuation tool, for ST terminal blocks, also suitable for use as a bladed screwdriver, size: 0.6 x 3.5 x 100 mm, 2-component grip, with non-slip grip

REL-MR- 24DC/21HC - Single relay

2961312

<https://www.phoenixcontact.com/us/products/2961312>



Plug-in miniature power relay, with power contact for high continuous currents, 1 changeover contact, input voltage 24 V DC

Phoenix Contact 2023 © - all rights reserved
<https://www.phoenixcontact.com>

Phoenix Contact USA
586 Fulling Mill Road
Middletown, PA 17057, United States
(+717) 944-1300
info@phoenixcon.com