



- Common Mode Choke / Line Filter
- UU10.5 Through Hole Design
- Horizontal Mount
- Extended Op. Temp. Range: -40°C to +130°C



Electrical Specifications @25°C				
Inductance N1 = N2	Test Frequency	DCR N1 = N2	Rated Current	Hi Pot VAC/5mA/60S
				Wdg-Wdg
160µH Min	1KHz, 1.0V	80mΩ Max	2.1A	2000

All specifications subject to change without notice.

**MECHANICAL**

Dimensions:  $\frac{\text{inch}}{\text{(mm)}}$

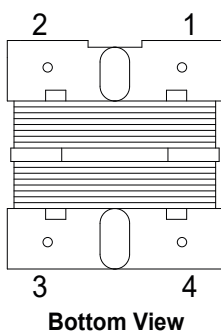
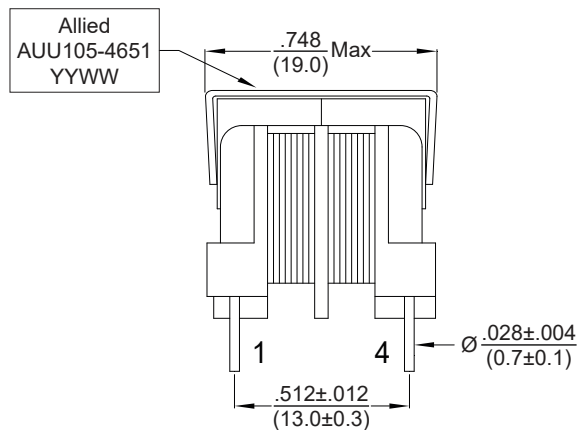
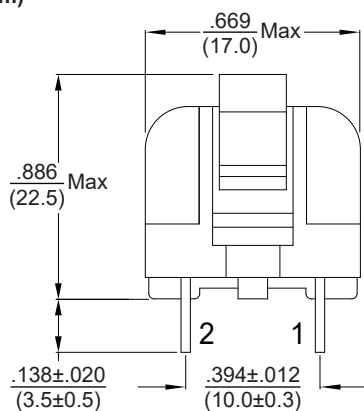

**SCHEMATIC**

