

## LP2966

# Dual 150mA Ultra Low-Dropout Regulator

### General Description

The LP2966 dual ultra low-dropout (LDO) regulator operates from a +2.70V to +7.0V input supply. Each output delivers 150mA over full temperature range. The IC operates with extremely low drop-out voltage and quiescent current, which makes it very suitable for battery powered and portable applications. Each LDO in the LP2966 has independent shutdown capability. The LP2966 provides low noise performance with low ground pin current in an extremely small MSOP-8 package (refer to package dimensions and connection diagram for more information on MSOP-8 package). A wide range of preset voltage options are available for each output. In addition to the voltage combinations listed in the ordering information table, many more are available upon request with minimum orders. In all, 256 voltage combinations are possible.

### Key Specifications

**Dropout Voltage:** Varies linearly with load current. Typically 0.9 mV at 1mA load current and 135mV at 150mA load current.

**Ground Pin Current:** Typically 300 $\mu$ A at 1mA load current and 340 $\mu$ A at 100mA load current (with one shutdown pin pulled low).

**Shutdown Mode:** Less than 1 $\mu$ A quiescent current when both shutdown pins are pulled low.

**Error Flag:** Open drain output, goes low when the corresponding output drops 10% below nominal.

**Precision Output Voltage:** Multiple output voltage options available ranging from 1.8V to 5.0V with a guaranteed accuracy of  $\pm 1\%$  at room temperature.

### Features

- Ultra low drop-out voltage
- Low ground pin current
- <1 $\mu$ A quiescent current in shutdown mode
- Independent shutdown of each LDO regulator
- Output voltage accuracy  $\pm 1\%$
- Guaranteed 150mA output current at each output
- Low output noise
- Error Flags indicate status of each output
- Available in MSOP-8 surface mount packages
- Low output capacitor requirements (1 $\mu$ F)
- Operates with Low ESR ceramic capacitors in most applications
- Over temperature/over current protection
- -40°C to +125°C junction temperature range

### Applications

- Cellular and Wireless Applications
- Palmtop/Laptop Computer
- GPS systems
- Flat panel displays
- Post regulators
- USB applications
- Hand held equipment and multimeters
- Wireless data terminals
- Other battery powered applications

### Typical Application Circuit

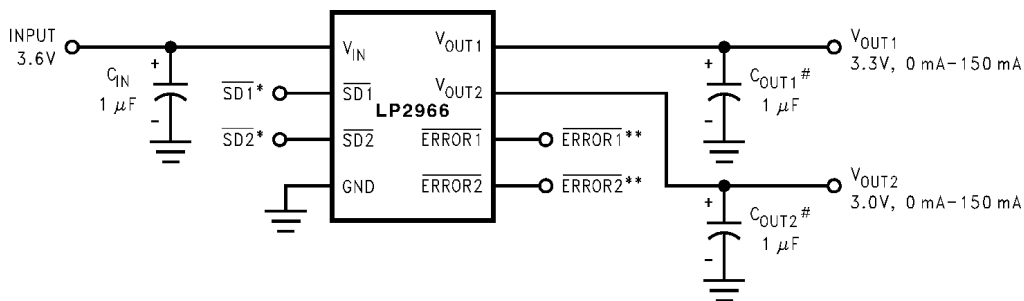

\*SD1 and SD2 must be actively terminated through a pull up resistor. Tie to V<sub>IN</sub> if not used.

\*\*ERROR1 and ERROR2 are open drain outputs. These pins must be connected to ground if not used.

# Minimum output capacitance is 1 $\mu$ F to insure stability over full load current range. More capacitance improves superior dynamic performance and provides additional stability margin.

10085030

### Block Diagram

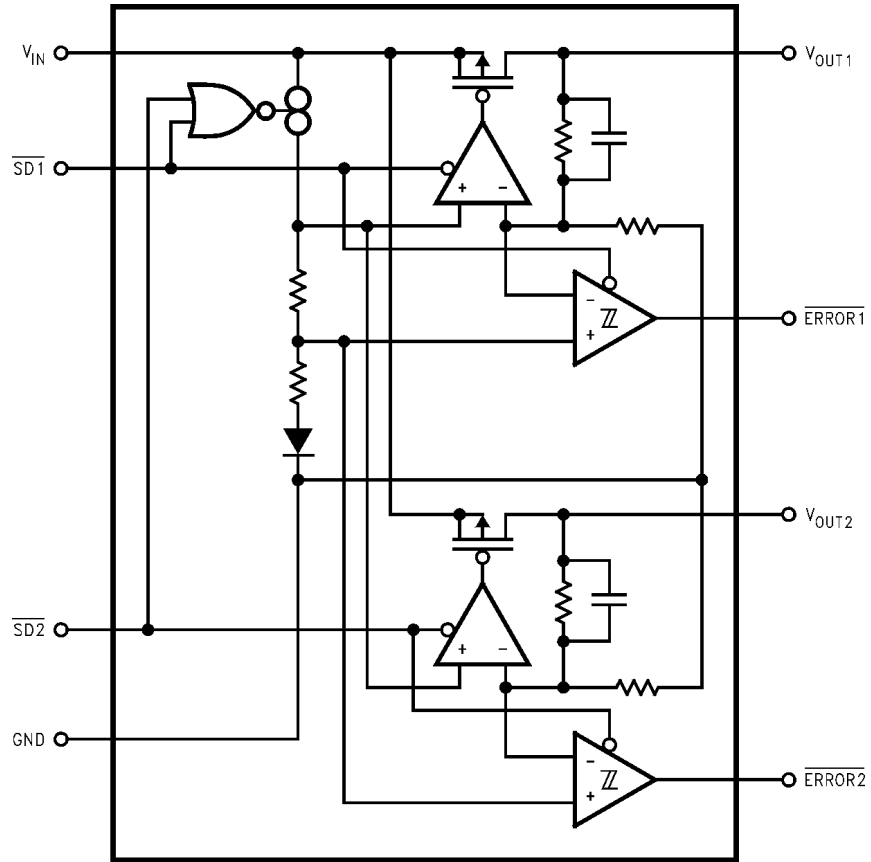

10085031

### Connection Diagram

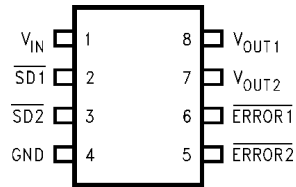

10085032

**Top View**  
**Mini SO-8 Package**  
**8-Lead Small Outline Integrated Circuit (SOIC)**  
**Package Code: MSOP-8**

## Pin Description

Pin	Name	Function
1	VIN	Input Supply pin
2	$\overline{SD1}$	Active low shutdown pin for output 1
3	$\overline{SD2}$	Active low shutdown pin for output 2
4	GND	Ground
5	$\overline{ERROR2}$	Error flag for output 2 - Normally high impedance, should be connected to ground if not used.
6	$\overline{ERROR1}$	Error flag for output 1 - Normally high impedance, should be connected to ground if not used.
7	VOUT2	Output 2
8	VOUT1	Output 1

## TABLE 1. Ordering Information

The following voltage options and their combinations are possible. 5.0V, 4.0V, 3.8V, 3.6V, 3.3V, 3.2V, 3.1V, 3.0V, 2.9V, 2.8V, 2.7V, 2.6V, 2.5V, 2.4V, 2.0V and 1.8V

Output Voltage 1	Output Voltage 2	Order Number	Package Marking	Supplied As:
5.0	5.0	LP2966IMM-5050	LAFB	1000 units on tape and reel
5.0	5.0	LP2966IMMX-5050	LAFB	3500 units on tape and reel
3.6	3.6	LP2966IMM-3636	LAEB	1000 units on tape and reel
3.6	3.6	LP2966IMMX-3636	LAEB	3500 units on tape and reel
3.3	3.6	LP2966IMM-3336	LAHB	1000 units on tape and reel
3.3	3.6	LP2966IMMX-3336	LAHB	3500 units on tape and reel
3.3	3.3	LP2966IMM-3333	LADB	1000 units on tape and reel
3.3	3.3	LP2966IMMX-3333	LADB	3500 units on tape and reel
3.3	2.5	LP2966IMM-3325	LARB	1000 units on tape and reel
3.3	2.5	LP2966IMMX-3325	LARB	3500 units on tape and reel
3.0	3.0	LP2966IMM-3030	LACB	1000 units on tape and reel
3.0	3.0	LP2966IMMX-3030	LACB	3500 units on tape and reel
2.8	3.0	LP2966IMM-2830	LASB	1000 units on tape and reel
2.8	3.0	LP2966IMMX-2830	LASB	3500 units on tape and reel
2.8	2.8	LP2966IMM-2828	LABB	1000 units on tape and reel
2.8	2.8	LP2966IMMX-2828	LABB	3500 units on tape and reel
2.5	2.5	LP2966IMM-2525	LAAB	1000 units on tape and reel
2.5	2.5	LP2966IMMX-2525	LAAB	3500 units on tape and reel
2.5	1.8	LP2966IMM-2518	LJKB	1000 units on tape and reel
2.5	1.8	LP2966IMMX-2518	LJKB	3500 units on tape and reel
1.8	3.3	LP2966IMM-1833	LCFB	1000 units on tape and reel
1.8	3.3	LP2966IMMX-1833	LCFB	3500 units on Tape and reel
1.8	3.0	LP2966IMM-1830	LEYB	1000 units on tape and reel
1.8	3.0	LP2966IMMX-1830	LEYB	3500 units on Tape and reel
1.8	2.8	LP2966IMM-1828	LAVB	1000 units on tape and reel
1.8	2.8	LP2966IMMX-1828	LAVB	3500 units on tape and reel
1.8	1.8	LP2966IMM-1818	LA9B	1000 units on tape and reel
1.8	1.8	LP2966IMMX-1818	LA9B	3500 units on tape and reel

The voltage options and combinations shown in *Table 1* are available. For other custom voltage options or combinations of voltage options, please contact your nearest National Semiconductor Sales Office.

**Absolute Maximum Ratings** (Note 1)

If Military/Aerospace specified devices are required, please contact the National Semiconductor Sales Office/Distributors for availability and specifications.

Storage Temperature Range	-65 to +150°C
Lead Temp. (Soldering, 5 sec.)	260°C
Power Dissipation (Note 2)	Internally Limited
ESD Rating (Note 3)	2kV
Input Supply Voltage (Survival)	-0.3V to 7.5V
Shutdown Input Voltage (Survival)	-0.3V to (V <sub>IN</sub> + 0.3V)
Maximum Voltage for $\overline{\text{ERROR}}$ Pins	10V
I <sub>OUT</sub> (Survival)	Short Circuit Protected

Output Voltage (Survival)(Note 6), -0.3V to (V<sub>IN</sub> + 0.3V)  
(Note 7)

**Operating Ratings** (Note 1)

Input Supply Voltage	2.7V to 7.0V
Shutdown Input Voltage	-0.3V to (V <sub>IN</sub> + 0.3V)
Operating Junction Temperature Range	-40°C to +125°C
Maximum Voltage for $\overline{\text{ERROR}}$ pins	10V

**Electrical Characteristics**

Limits in standard typeface are for T<sub>j</sub> = 25°C, and limits in **boldface type** apply over the full operating junction temperature range. Unless otherwise specified, V<sub>IN</sub> = V<sub>O(NOM)</sub> + 1V, (Note 16), C<sub>OUT</sub> = 1μF, I<sub>OUT</sub> = 1mA, C<sub>IN</sub> = 1μF, V<sub>SD1</sub> = V<sub>SD2</sub> = V<sub>IN</sub>.

Symbol	Parameter	Conditions	Typ (Note 4)	LP2966IMM (Note 5)		Unit	
				Min	Max		
V <sub>o</sub> (Note 13)	Output Voltage Tolerance	V <sub>OUT</sub> + 1V < V <sub>IN</sub> < 7.0V	0.0	-1	1	%V <sub>NOM</sub>	
		1mA < I <sub>L</sub> < 100mA	0.0	-3	3	%V <sub>NOM</sub>	
					-1.5	1.5	%V <sub>NOM</sub>
					-3.5	3.5	
ΔV <sub>O</sub> /ΔV <sub>IN</sub> (Note 8) (Note 13)	Output Voltage Line Regulation		0.1			mV/V	
ΔV <sub>O</sub> /ΔI <sub>OUT</sub>	Output Voltage Load Regulation (Note 9)	1mA < I <sub>L</sub> < 100mA (Note 9)	0.1			mV/mA	
ΔV <sub>O2</sub> /ΔI <sub>OUT1</sub>	Output Voltage Cross Regulation (Note 10)	1mA < I <sub>L1</sub> < 100mA (Note 10)	0.0004			mV/mA	
V <sub>IN</sub> -V <sub>OUT</sub>	Dropout Voltage (Note 12)	I <sub>L</sub> = 1mA	0.9		2.0	mV	
		I <sub>L</sub> = 100mA	90		130		
		I <sub>L</sub> = 150mA			180		
				135			195
					270		
I <sub>GND(1,0)</sub> (Note 18)	Ground Pin Current (One LDO On)	I <sub>L</sub> = 1mA V <sub>SD2</sub> ≤ 0.1V, V <sub>SD1</sub> = V <sub>IN</sub>	<b>300</b>			μA	
		I <sub>L</sub> = 100mA V <sub>SD2</sub> ≤ 0.1V, V <sub>SD1</sub> = V <sub>IN</sub>	<b>340</b>				
I <sub>GND(1,1)</sub>	Ground Pin Current (Both LDOs On)	I <sub>L</sub> = 1mA	340		450	μA	
		I <sub>L</sub> = 100mA			500		
				420			540
					600		
I <sub>GND(0,0)</sub>	Ground Pin Current in Shutdown Mode	V <sub>SD1</sub> = V <sub>SD2</sub> ≤ 0.1V	0.006		0.3	μA	
					10		
I <sub>O(PK)</sub>	Peak Output Current	(Note 2)	500	350		mA	
		V <sub>OUT</sub> ≥ V <sub>OUT(NOM)</sub> - 5%		<b>150</b>			
<b>Short Circuit Foldback Protection</b>							
I <sub>FB</sub>	Short Circuit Foldback Knee	(Note 2), (Note 14)	600			mA	
<b>Over Temperature Protection</b>							
Tsh(t)	Shutdown Threshold		165			°C	

## Electrical Characteristics (Continued)

Limits in standard typeface are for  $T_j = 25^\circ\text{C}$ , and limits in **boldface type** apply over the full operating junction temperature range. Unless otherwise specified,  $V_{IN} = V_{O(NOM)} + 1\text{V}$ , (Note 16),  $C_{OUT} = 1\mu\text{F}$ ,  $I_{OUT} = 1\text{mA}$ ,  $C_{IN} = 1\mu\text{F}$ ,  $V_{SD1} = V_{SD2} = V_{IN}$ .

Symbol	Parameter	Conditions	Typ (Note 4)	LP2966IMM (Note 5)		Unit
				Min	Max	
Tsh(h)	Thermal Shutdown Hysteresis		25			$^\circ\text{C}$
<b>Shutdown Input</b>						
$V_{SDT}$	Shutdown Threshold (Note 15)	Output = Low	0		<b>0.1</b>	V
		Output = High	$V_{IN}$	<b><math>V_{IN} - 0.1</math></b>		
$T_{dOFF}$	Turn-off Delay (Note 17)	$I_L = 100\text{mA}$	20			$\mu\text{sec}$
$T_{dON}$	Turn-on Delay (Note 17)	$I_L = 100\text{mA}$	25			$\mu\text{sec}$
$I_{SD}$	SD Input Current	$V_{SD} = V_{IN}$	1			nA
		$V_{SD} = 0\text{V}$	1			
<b>Error Flag Comparators</b>						
$V_T$	Threshold (output goes high to low)	(Note 11)	10	<b>5</b>	<b>16</b>	%
$V_{TH}$	Threshold Hysteresis	(Note 11)	5	<b>2</b>	<b>8</b>	%
$V_{ERR(Sat)}$	Error Flag Saturation	$I_{Fsink} = 100\mu\text{A}$	0.015		<b>0.1</b>	V
$I_{EF(leak)}$	Error Flag Pin Leakage Current		1			nA
$I_{EF(sink)}$	Error Flag Pin Sink Current		1			mA
<b>AC Parameters</b>						
PSRR	Ripple Rejection	$V_{IN} = V_{OUT} + 1\text{V}$ , $f = 120\text{Hz}$ , $V_{OUT} = 3.3\text{V}$	60			dB
		$V_{IN} = V_{OUT} + 0.3\text{V}$ , $f = 120\text{Hz}$ , $V_{OUT} = 3.3\text{V}$	40			
$\rho_n(1/f)$	Output Noise Density	$f = 120\text{Hz}$	1			$\mu\text{V}/\sqrt{\text{Hz}}$
$e_n$	Output Noise Voltage (rms)	$\text{BW} = 10\text{Hz} - 100\text{kHz}$ , $C_{OUT} = 10\mu\text{F}$	150			$\mu\text{V(rms)}$
		$\text{BW} = 300\text{Hz} - 300\text{kHz}$ , $C_{OUT} = 10\mu\text{F}$	100			

**Note 1:** Absolute maximum ratings indicate limits beyond which damage to the device may occur. Operating ratings indicate conditions for which the device is intended to be functional, but do not guarantee specific performance limits. For guaranteed specifications and test conditions, see Electrical characteristics. The guaranteed specifications apply only for the test conditions listed. Some performance characteristics may degrade when the device is not operated under the listed test conditions.

**Note 2:** At elevated temperatures, devices must be derated based on package thermal resistance. The device in the surface-mount package must be derated at  $\theta_{JA} = 235^\circ\text{C/W}$ , junction-to-ambient. Please refer to the applications section on maximum current capability for further information. The device has internal thermal protection.

**Note 3:** The human body model is a 100pF capacitor discharged through a 1.5k $\Omega$  resistor into each pin.

**Note 4:** : Typical numbers are at 25 $^\circ\text{C}$  and represent the most likely parametric norm.

**Note 5:** : Limits are 100% production tested at 25 $^\circ\text{C}$ . Limits over the operating temperature range are guaranteed through correlation using Statistical Quality Control (SQC) methods. The limits are used to calculate National's Averaging Outgoing Quality Level (AOQL).

**Note 6:** If used in a dual-supply system where the regulator load is returned to a negative supply, the LP2966 output must be diode-clamped to ground.

**Note 7:** The output PMOS structure contains a diode between the  $V_{IN}$  and  $V_{OUT}$  terminals that is normally reverse-biased. Reversing the polarity from  $V_{IN}$  and  $V_{OUT}$  will turn on this diode.

**Note 8:** Output voltage line regulation is defined as the change in output voltage from the nominal value due to change in input line voltage.

**Note 9:** Output voltage load regulation is defined as the change in output voltage from the nominal value when the load current changes from 1mA to 100mA.

**Note 10:** Output voltage cross regulation is defined as the percentage change in the output voltage from the nominal value at one output when the load current changes from 1mA to full load in the other output. This is an important parameter in multiple output regulators. The specification for  $\Delta V_{O1}/\Delta I_{OUT2}$  is equal to the specification for  $\Delta V_{O2}/\Delta I_{OUT1}$ .

**Note 11:** Error Flag threshold and hysteresis are specified as the percentage below the regulated output voltage.

**Note 12:** Dropout voltage is defined as the input to output differential at which the output voltage drops 100mV below the nominal value. Drop-out voltage specification applies only to output voltages greater than 2.7V. For output voltages below 2.7V, the drop-out voltage is nothing but the input to output differential, since the minimum input voltage is 2.7V.

## Electrical Characteristics (Continued)

**Note 13:** Output voltage tolerance specification also includes the line regulation and load regulation.

**Note 14:** LP2966 has fold back current limited short circuit protection. The knee is the current at which the output voltage drops 10% below the nominal value.

**Note 15:**  $V_{SDT}$  is the shutdown pin voltage threshold below which the output is disabled.

**Note 16:** The condition  $V_{IN} = V_{O(NOM)} + 1V$  applies when  $V_{out1} = V_{out2}$ . If  $V_{out1} \neq V_{out2}$ , then this condition would apply to the output which is greater in value. As an example, if  $V_{out1} = 3.3V$  and  $V_{out2} = 5V$ , then the condition  $V_{IN} = V_{O(NOM)} + 1V$  would apply to  $V_{out2}$  only.

**Note 17:** Turn-on delay is the time interval between the low to high transition on the shutdown pin to the output voltage settling to within 5% of the nominal value. Turn-off delay is the time interval between the high to low transition on the shutdown pin to the output voltage dropping below 50% of the nominal value. The external load impedance influences the output voltage decay in shutdown mode.

**Note 18:** The limits for the ground pin current specification,  $I_{GND(0,1)}$  will be same as the limits for the specification,  $I_{GND(1,0)}$ .

**Typical Performance Characteristics** Unless otherwise specified,  $V_{IN} = V_{O(NOM)} + 1V$ ,  $V_{OUT} = 3.3V$ ,  $C_{OUT} = 1\mu F$ ,  $I_{OUT} = 1mA$ ,  $C_{IN} = 1\mu F$ ,  $V_{SD1} = V_{SD2} = V_{IN}$ , and  $T_A = 25^\circ C$ .

**Ground Pin Current vs Supply Voltage (one LDO on)**

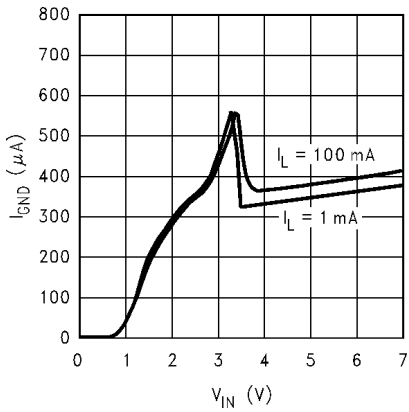

10085001

**Ground Pin Current vs Supply Voltage (both LDOs on)**

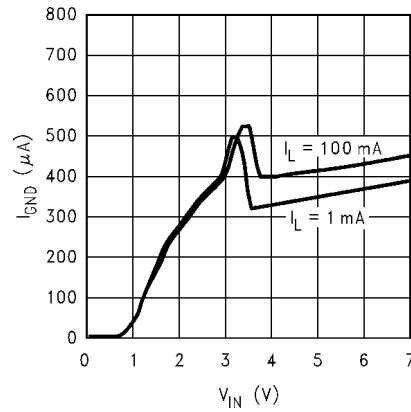

10085002

**Ground Pin Current vs Load Current over temperature (one LDO on)**

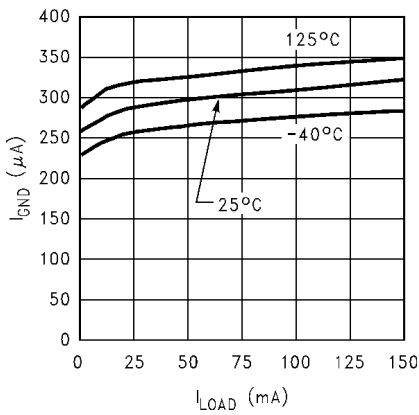

10085003

**Ground Pin Current vs Load Current over temperature (both LDOs on)**

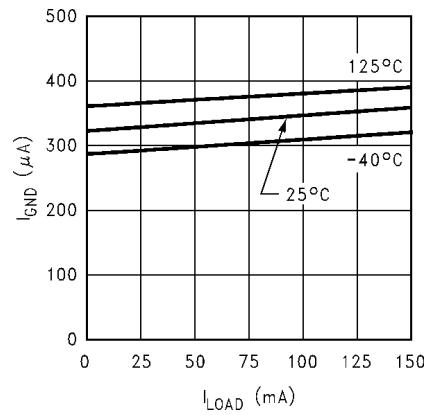

10085004

**Output Voltage vs Temperature**

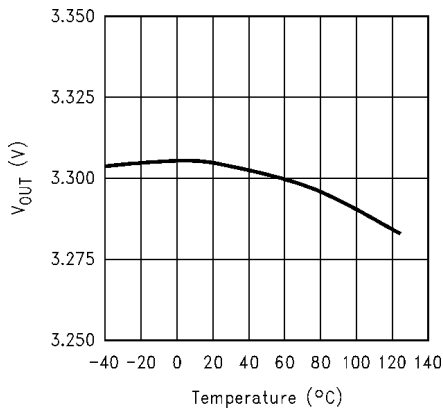

10085005

**Drop-out Voltage vs Temperature**

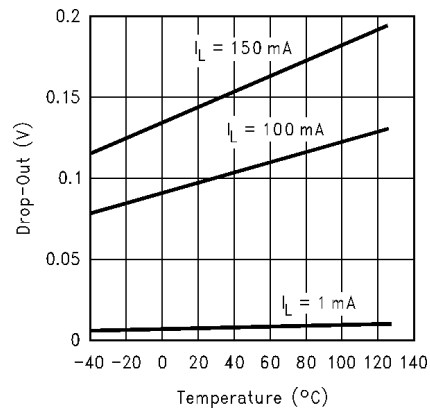

10085006

**Typical Performance Characteristics** Unless otherwise specified,  $V_{IN} = V_{O(NOM)} + 1V$ ,  $V_{OUT} = 3.3V$ ,  $C_{OUT} = 1\mu F$ ,  $I_{OUT} = 1mA$ ,  $C_{IN} = 1\mu F$ ,  $V_{SD1} = V_{SD2} = V_{IN}$ , and  $T_A = 25^\circ C$ . (Continued)

**Input Voltage vs Output Voltage**

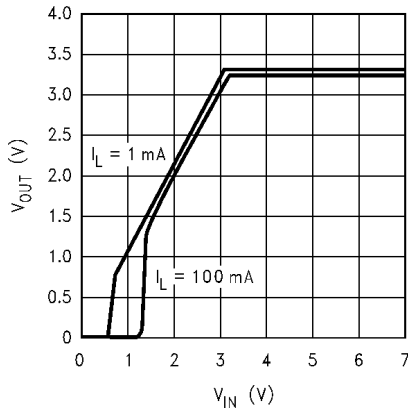

10085007

**Ground Pin Current vs Shutdown Pin Voltage**

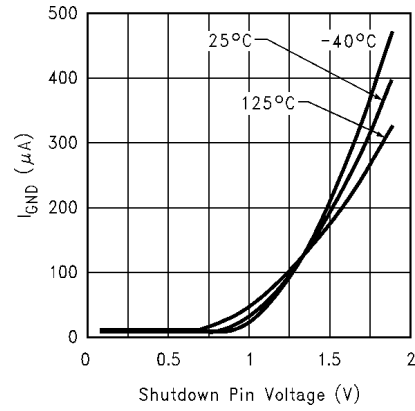

10085008

**Ground Pin Current vs Input Voltage (Both LDOs off)**

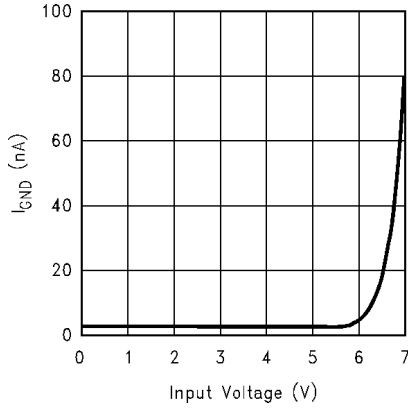

10085009

**Short-Circuit Foldback Protection**

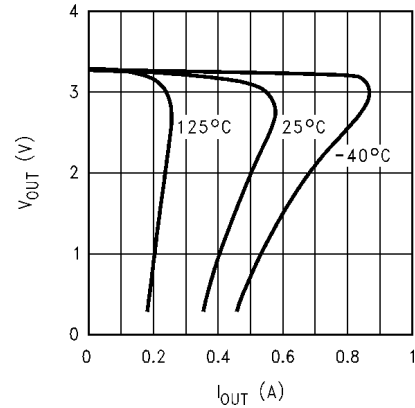

10085010

**Line Transient Response  
( $C_{OUT} = 2.2\mu F$ ,  $I_{OUT} = 1mA$ )**

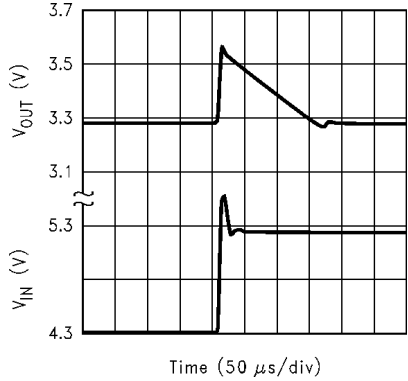

10085018

**Line Transient Response  
( $C_{OUT} = 2.2\mu F$ ,  $I_{OUT} = 1mA$ )**

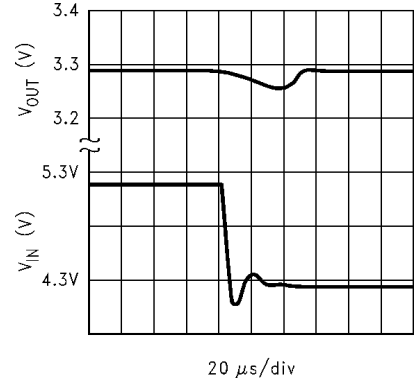

10085019



**Typical Performance Characteristics** Unless otherwise specified,  $V_{IN} = V_{O(NOM)} + 1V$ ,  $V_{OUT} = 3.3V$ ,  $C_{OUT} = 1\mu F$ ,  $I_{OUT} = 1mA$ ,  $C_{IN} = 1\mu F$ ,  $V_{SD1} = V_{SD2} = V_{IN}$ , and  $T_A = 25^\circ C$ . (Continued)

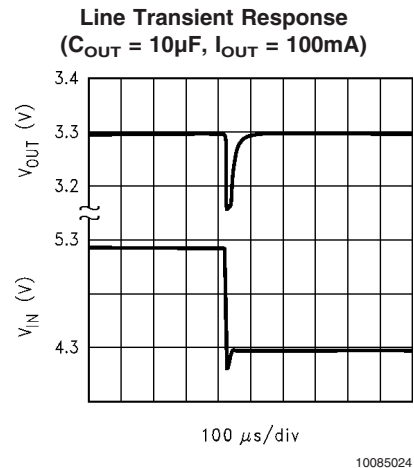
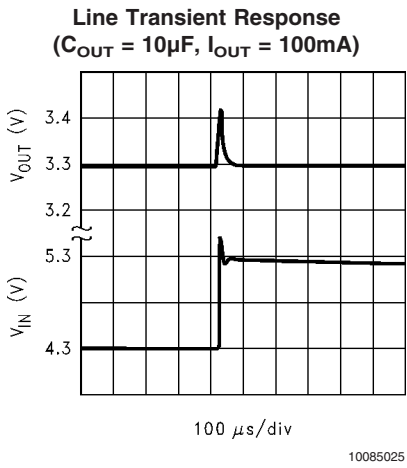
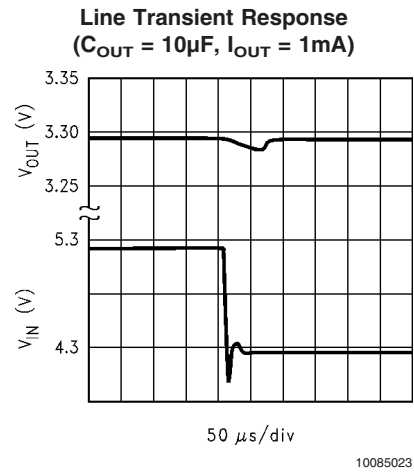
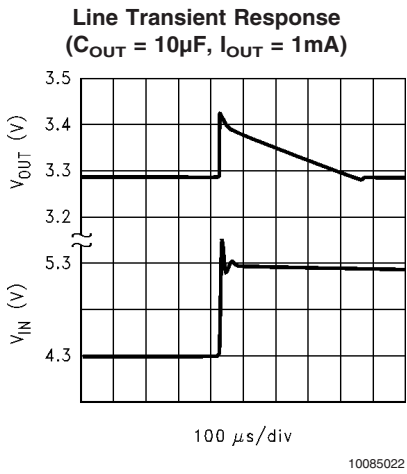
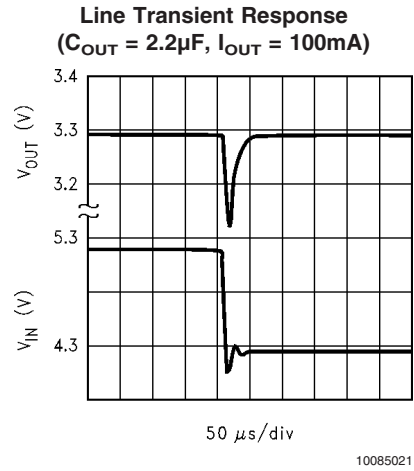
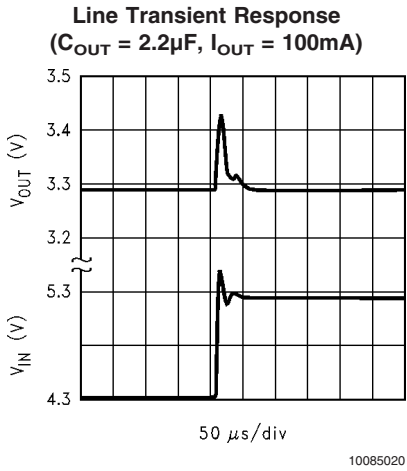

**Typical Performance Characteristics** Unless otherwise specified,  $V_{IN} = V_{O(NOM)} + 1V$ ,  $V_{OUT} = 3.3V$ ,  $C_{OUT} = 1\mu F$ ,  $I_{OUT} = 1mA$ ,  $C_{IN} = 1\mu F$ ,  $V_{SD1} = V_{SD2} = V_{IN}$ , and  $T_A = 25^\circ C$ . (Continued)

**Load Transient Response ( $C_{OUT} = 2.2\mu F$ )**

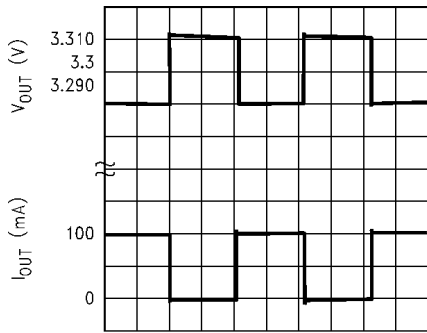

10 ms/div

10085026

**Load Transient Response ( $C_{OUT} = 10\mu F$ )**

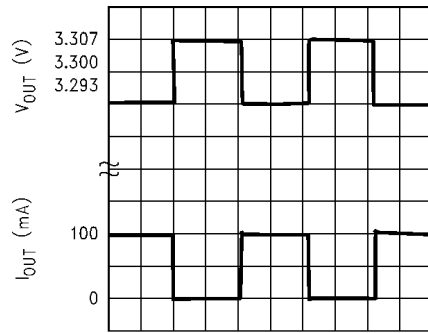

10 ms/div

10085027

**Load Transient Response ( $C_{OUT} = 10\mu F$ )**

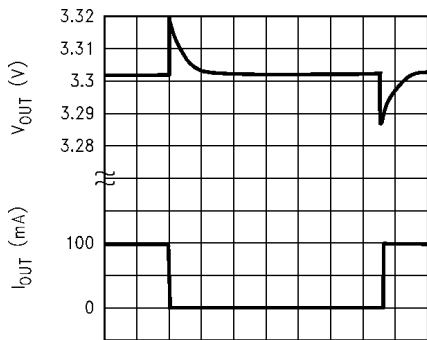

500 ms/div

10085028

**Load Transient Response ( $C_{OUT} = 2.2\mu F$ )**

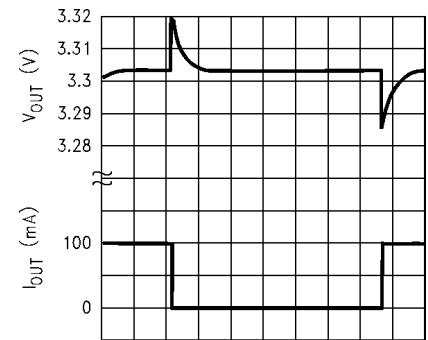

500 ms/div

10085029

**Cross-Channel Isolation vs Frequency ( $I_{OUT1} = 1mA$ ,  $I_{OUT2} = 1mA$ )**

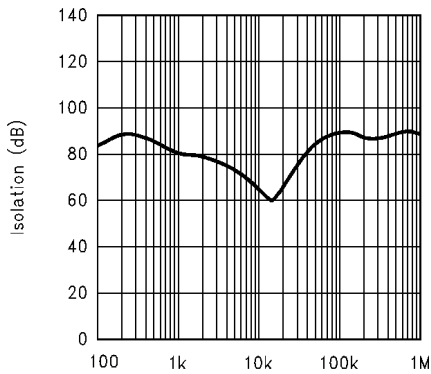

Frequency (Hz)

10085015

**Cross-Channel Isolation vs Frequency ( $I_{OUT1} = I_{OUT2} = 100mA$ )**

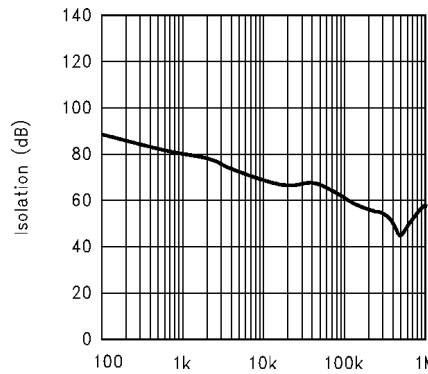

Frequency (Hz)

10085016

**Typical Performance Characteristics** Unless otherwise specified,  $V_{IN} = V_{O(NOM)} + 1V$ ,  $V_{OUT} = 3.3V$ ,  $C_{OUT} = 1\mu F$ ,  $I_{OUT} = 1mA$ ,  $C_{IN} = 1\mu F$ ,  $V_{SD1} = V_{SD2} = V_{IN}$ , and  $T_A = 25^\circ C$ . (Continued)

**Output Voltage Cross-Coupling**

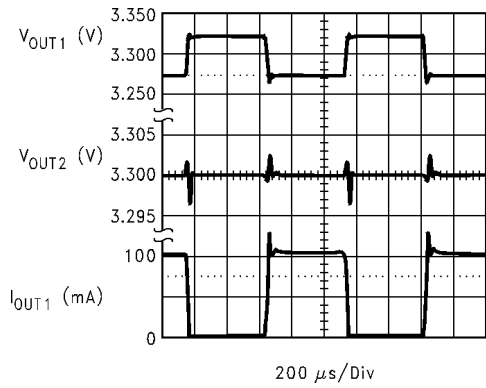

10085013

**Output Noise Density**

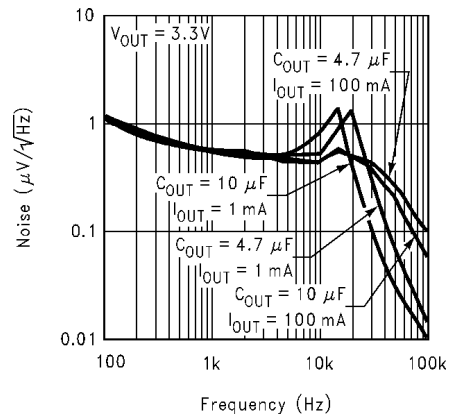

10085014

**Power Supply Ripple Rejection**

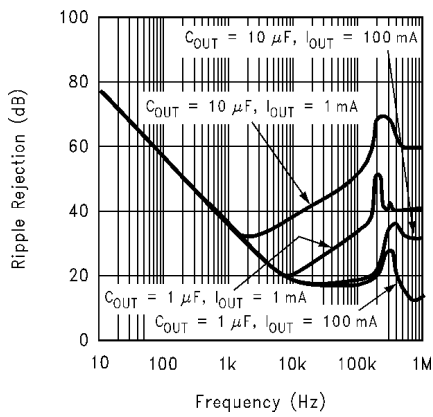

10085017

**Peak Output Current vs Temperature**

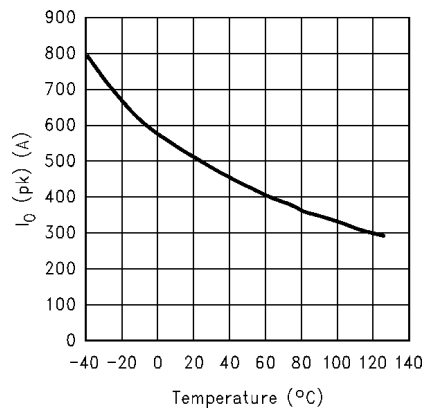

10085041

## Applications Information

### Input Capacitor Selection

LP2966 requires a minimum input capacitance of  $1\mu\text{F}$  between the input and ground pins to prevent any impedance interactions with the supply. This capacitor should be located very close to the input pin. This capacitor can be of any type such as ceramic, tantalum, or aluminium. Any good quality capacitor which has good tolerance over temperature and frequency is recommended.

### Output Capacitor Selection

The LP2966 requires a minimum of  $1\mu\text{F}$  capacitance on each output for proper operation. To insure stability, this capacitor should maintain its ESR (equivalent series resistance) in the stable region of the ESR curves (*Figure 1* and *Figure 2*) over the full operating temperature range of the application. The output capacitor should have a good tolerance over temperature, voltage, and frequency. The output capacitor can be increased without limit. Larger capacitance provides better stability and noise performance. The output capacitor should be connected very close to the  $V_{\text{out}}$  pin of the IC.

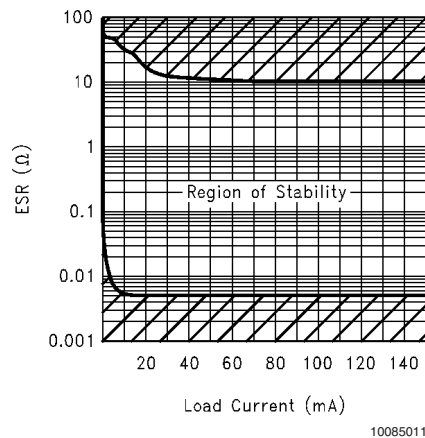

FIGURE 1. ESR Curve for  $V_{\text{OUT}} = 5\text{V}$  and  $C_{\text{OUT}} = 2.2\mu\text{F}$

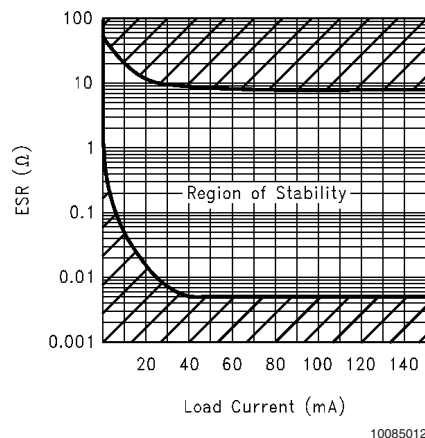

FIGURE 2. ESR Curve for  $V_{\text{OUT}} = 3.3\text{V}$  and  $C_{\text{OUT}} = 2.2\mu\text{F}$

LP2966 works best with Tantalum capacitors. However, the ESR and the capacitance value of these capacitors vary a lot with temperature, voltage, and frequency. So while using

Tantalum capacitors, it should be ensured that the ESR is within the limits for stability over the full operating temperature range.

For output voltages greater than 2.5V, good quality ceramic capacitors (such as the X7R series from Taiyoyuden) can also be used with LP2966 in applications not requiring light load operation ( $< 5\text{mA}$  for the 5V output option). Once again, it should be ensured that the capacitance value and the ESR are within the limits for stability over the full operating temperature range.

The ESRD Series Polymer Aluminium Electrolytic capacitors from Cornell Dubilier are very stable over temperature and frequency. The excellent capacitance and ESR tolerance of these capacitors over voltage, temperature and frequency make these capacitors very suitable for use with LDO regulators.

### Output Noise

Noise is specified in two ways-

**Spot Noise** or **Output noise density** is the RMS sum of all noise sources, measured at the regulator output, at a specific frequency (measured with a 1Hz bandwidth). This type of noise is usually plotted on a curve as a function of frequency.

**Total output Noise** or **Broad-band noise** is the RMS sum of spot noise over a specified bandwidth, usually several decades of frequencies.

Attention should be paid to the units of measurement. Spot noise is measured in units  $\mu\text{V}/\sqrt{\text{Hz}}$  or  $\text{nV}/\sqrt{\text{Hz}}$  and total output noise is measured in  $\mu\text{V}(\text{rms})$ .

The primary source of noise in low-dropout regulators is the internal reference. In CMOS regulators, noise has a low frequency component and a high frequency component, which strongly depend on the silicon area and quiescent current. Noise can be reduced in two ways: by increasing the transistor area or by increasing the current drawn by the internal reference. Increasing the area will increase the die size and decreases the chance of fitting the die into a small package. Increasing the current drawn by the internal reference increases the total supply current (ground pin current) of the IC. Using an optimized trade-off of ground pin current and die size, LP2966 achieves low noise performance with low quiescent current in an MSOP-8 package.

### Short-Circuit Foldback protection

In the presence of a short or excessive load current condition, the LP2966 uses an internal short circuit foldback mechanism that regulates the maximum deliverable output current. A strong negative temperature coefficient is designed into the circuit to enable extremely higher peak output current capability (in excess of 400mA per output at room temperature, see typical curves). Thus, a system designer using the LP2966 can achieve higher peak output current capability in applications where the LP2966 internal junction temperature is kept below  $125^\circ\text{C}$ . Refer to the applications section on calculating the maximum output current capability of the LP2966 for your application.

### Error Flag Operation

The LP2966 produces a logic low signal at the Error Flag pin (ERROR) when the corresponding output drops out of regulation due to low input voltage, current limiting, or thermal limiting. This flag has a built in Hysteresis. The timing diagram in *Figure 3* shows the relationship between the ERROR and the output voltage. In this example, the input voltage is changed to demonstrate the functionality of the Error Flag.

## Applications Information (Continued)

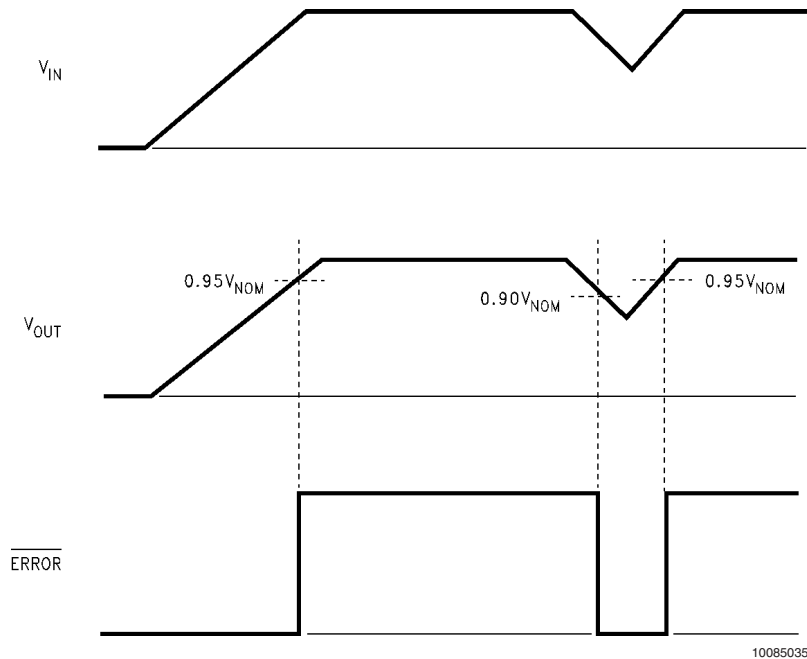

FIGURE 3. Error Flag Operation

The internal error flag comparators have open drain output stages. Hence, the  $\overline{\text{ERROR}}$  pins should be pulled high through a pull up resistor. Although the  $\overline{\text{ERROR}}$  pin can sink current of 1mA, this current adds to the battery drain. Hence, the value of the pull up resistor should be in the range of 100k $\Omega$  to 1M $\Omega$ . **The  $\overline{\text{ERROR}}$  pins must be connected to ground if this function is not used.** It should also be noted that when the shutdown pins are pulled low, the  $\overline{\text{ERROR}}$  pins are forced to be invalid for reasons of saving power in shutdown mode.

### Shutdown Operation

The two LDO regulators in the LP2966 have independent shutdown. A CMOS Logic level signal at the shutdown( $\overline{\text{SD}}$ ) pin will turn-off the corresponding regulator. Pins  $\overline{\text{SD1}}$  and  $\overline{\text{SD2}}$  must be actively terminated through a 100k $\Omega$  pull-up resistor for a proper operation. If these pins are driven from a source that actively pulls high and low (such as a CMOS rail to rail comparator), the pull-up resistor is not required. These pins must be tied to  $V_{in}$  if not used.

### Drop-Out Voltage

The drop-out voltage of a regulator is defined as the minimum input-to-output differential required to stay within 100mV of the output voltage measured with a 1V differential. The LP2966 uses an internal MOSFET with an  $R_{ds(on)}$  of 1 $\Omega$ . For CMOS LDOs, the drop-out voltage is the product of the load current and the  $R_{ds(on)}$  of the internal MOSFET.

### Reverse Current Path

The internal MOSFET in the LP2966 has an inherent parasitic diode. During normal operation, the input voltage is

higher than the output voltage and the parasitic diode is reverse biased. However, if the output is pulled above the input in an application, then current flows from the output to the input as the parasitic diode gets forward biased. The output can be pulled above the input as long as the current in the parasitic diode is limited to 150mA.

### Maximum Output Current Capability

Each output in the LP2966 can deliver a current of more than 150mA over the full operating temperature range. However, the maximum output current capability should be derated by the junction temperature. Under all possible conditions, the junction temperature must be within the range specified under operating conditions. The LP2966 is available in MSOP-8 package. This package has a junction to ambient temperature coefficient ( $\theta_{ja}$ ) of 235  $^{\circ}\text{C}/\text{W}$  with minimum amount of copper area. The total power dissipation of the device is approximately given by:

$$P_D = (V_{in} - V_{OUT1})I_{OUT1} + (V_{in} - V_{OUT2})I_{OUT2}$$

The maximum power dissipation,  $P_{Dmax}$ , that the device can tolerate can be calculated by using the formula

$$P_{Dmax} = (T_{jmax} - T_A)/\theta_{ja}$$

where  $T_{jmax}$  is the maximum specified junction temperature (125 $^{\circ}\text{C}$ ), and  $T_A$  is the ambient temperature.

The following figures show the variation of thermal coefficient with different layout scenarios.

Applications Information (Continued)

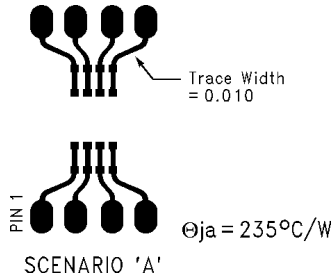

FIGURE 4.

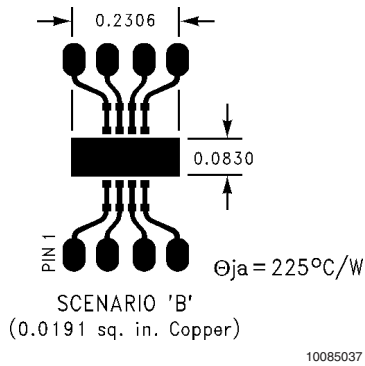

FIGURE 5.

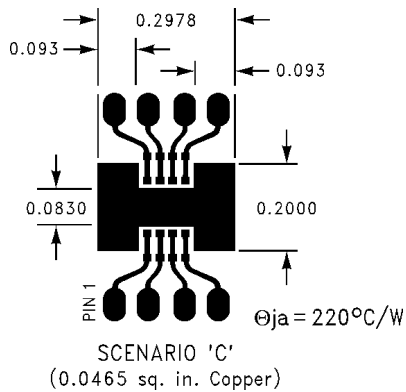

FIGURE 6.

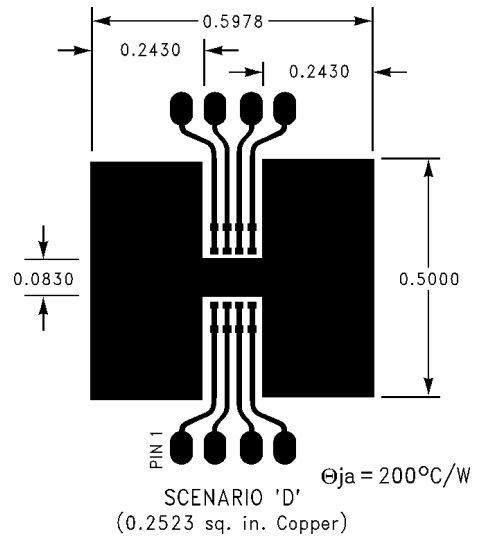

FIGURE 7.

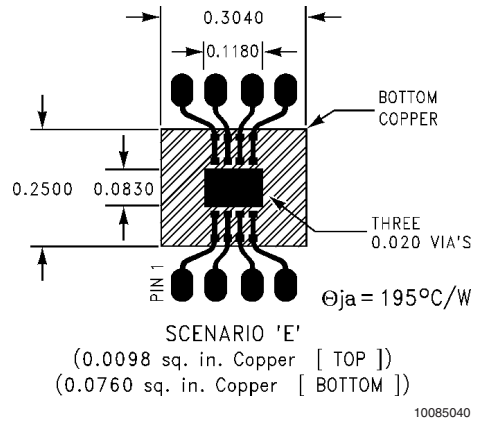
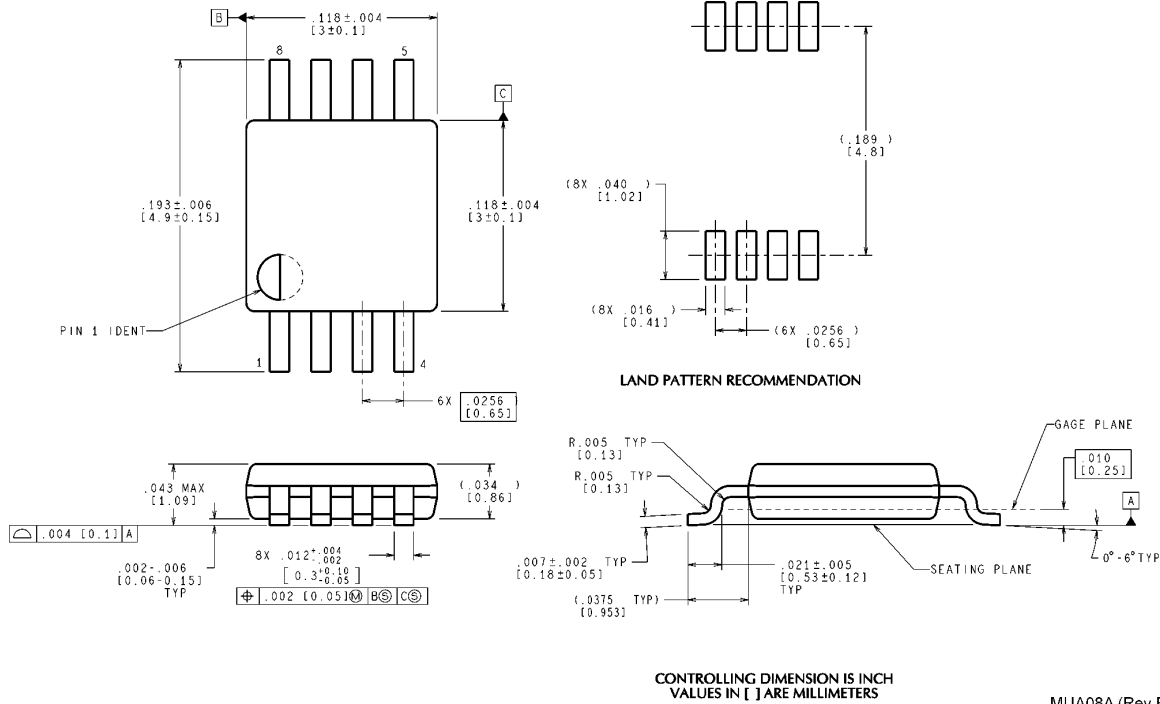

FIGURE 8.

## Physical Dimensions inches (millimeters)

unless otherwise noted



**Mini SO-8 Package Type MM**  
**For Ordering, Refer to Ordering Information Table**  
**NS Package Number MUA08A**

National does not assume any responsibility for use of any circuitry described, no circuit patent licenses are implied and National reserves the right at any time without notice to change said circuitry and specifications.

For the most current product information visit us at [www.national.com](http://www.national.com).

### LIFE SUPPORT POLICY

NATIONAL'S PRODUCTS ARE NOT AUTHORIZED FOR USE AS CRITICAL COMPONENTS IN LIFE SUPPORT DEVICES OR SYSTEMS WITHOUT THE EXPRESS WRITTEN APPROVAL OF THE PRESIDENT AND GENERAL COUNSEL OF NATIONAL SEMICONDUCTOR CORPORATION. As used herein:

1. Life support devices or systems are devices or systems which, (a) are intended for surgical implant into the body, or (b) support or sustain life, and whose failure to perform when properly used in accordance with instructions for use provided in the labeling, can be reasonably expected to result in a significant injury to the user.
2. A critical component is any component of a life support device or system whose failure to perform can be reasonably expected to cause the failure of the life support device or system, or to affect its safety or effectiveness.

### BANNED SUBSTANCE COMPLIANCE

National Semiconductor manufactures products and uses packing materials that meet the provisions of the Customer Products Stewardship Specification (CSP-9-111C2) and the Banned Substances and Materials of Interest Specification (CSP-9-111S2) and contain no "Banned Substances" as defined in CSP-9-111S2.



**National Semiconductor**  
**Americas Customer**  
**Support Center**  
 Email: [new.feedback@nsc.com](mailto:new.feedback@nsc.com)  
 Tel: 1-800-272-9959

**National Semiconductor**  
**Europe Customer Support Center**  
 Fax: +49 (0) 180-530 85 86  
 Email: [europe.support@nsc.com](mailto:europe.support@nsc.com)  
 Deutsch Tel: +49 (0) 69 9508 6208  
 English Tel: +44 (0) 870 24 0 2171  
 Français Tel: +33 (0) 1 41 91 8790

**National Semiconductor**  
**Asia Pacific Customer**  
**Support Center**  
 Email: [ap.support@nsc.com](mailto:ap.support@nsc.com)

**National Semiconductor**  
**Japan Customer Support Center**  
 Fax: 81-3-5639-7507  
 Email: [jpn.feedback@nsc.com](mailto:jpn.feedback@nsc.com)  
 Tel: 81-3-5639-7560