

## L0806B390JSWST

Aliases (L0806B390JSWST)

Not for New Design

KEMET, L-SWS, Commercial Grade, 39 uH, 5%

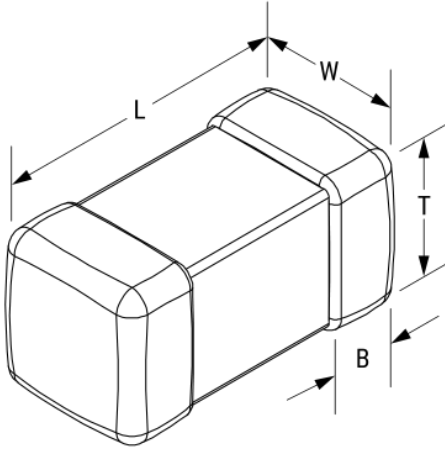

Click [here](#) for the 3D model.

### General Information

Series	L-SWS
Style	SMD Chip
RoHS	Yes
Notes	Last Order Date June 30, 2023.

### Specifications

Inductance	39 uH
Inductance Tolerance	5%
Temperature Range	-40/+105°C
Current	120 mAmps (MAX)
DC Resistance	3.9 Ohms
Self-Resonant Frequency	14 MHz MIN

### Dimensions

Chip Size	0806
L	2mm +/-0.2mm
W	1.6mm +/-0.2mm
T	1.6mm +/-0.2mm
B	0.5mm +/-0.2mm

### Packaging Specifications

Packaging	T&R
Packaging Quantity	2000

Statements of suitability for certain applications are based on our knowledge of typical operating conditions for such applications, but are not intended to constitute - and we specifically disclaim - any warranty concerning suitability for a specific customer application or use. This information is intended for use only by customers who have the requisite experience and capability to determine the correct products for their application. Any technical advice inferred from this information or otherwise provided by us with reference to the use of our products is given gratis, and we assume no obligation or liability for the advice given or results obtained.