

-20V, 200mA, Ultralow Noise, Ultrahigh PSRR Negative Linear Regulator

FEATURES

- **Ultralow RMS Noise: 0.8μV_{RMS} (10Hz to 100kHz)**
- **Ultralow Spot Noise: 2.2nV/√Hz at 10kHz**
- **Ultrahigh PSRR: 73dB at 1MHz**
- **Output Current: 200mA**
- **Wide Input Voltage Range: -1.8V to -20V**
- **Single Capacitor Improves Noise and PSRR**
- **100μA SET Pin Current: ±1% Initial Accuracy**
- Single Resistor Programs Output Voltage
- Programmable Current Limit
- Low Dropout Voltage: 190mV
- Output Voltage Range: 0V to -19.5V
- Programmable Power Good and Fast Start-Up
- Bipolar Precision Enable/UVLO Pin
- VIOC Pin Controls Upstream Regulator to Minimize Power Dissipation and Optimize PSRR
- Minimum Output Capacitor: 4.7μF Ceramic
- 12-Lead MSOP and 3mm × 3mm DFN Packages

APPLICATIONS

- RF and Precision Power Supplies
- Very Low Noise Instrumentation
- High Speed/High Precision Data Converters
- Medical Applications: Diagnostics and Imaging
- Post-Regulator for Switching Supplies

DESCRIPTION

The **LT[®]3093** is a high performance low dropout negative linear regulator featuring ADI's ultralow noise and ultrahigh PSRR architecture for powering noise sensitive applications. The device can be easily paralleled to further reduce noise, increase output current and spread heat on a PCB.

The LT3093 supplies 200mA at a typical 190mV dropout voltage. Operating quiescent current is nominally 2.35mA and drops to 3μA in shutdown. The device's wide output voltage range (0V to -19.5V) error amplifier operates in unity-gain and provides virtually constant output noise, PSRR, bandwidth, and load regulation independent of the programmed output voltage. Additional features are a bipolar enable pin, programmable current limit, fast start-up capability and programmable power good to indicate output voltage regulation. The regulator incorporates a tracking function to control an upstream supply to maintain a constant voltage across the LT3093 to minimize power dissipation and optimize PSRR.

The LT3093 is stable with a minimum 4.7μF ceramic output capacitor. Built-in protection includes internal current limit with foldback and thermal limit with hysteresis. The LT3093 is available in thermally enhanced 12-Lead MSOP and 3mm × 3mm DFN Packages.

All registered trademarks and trademarks are the property of their respective owners.

TYPICAL APPLICATION

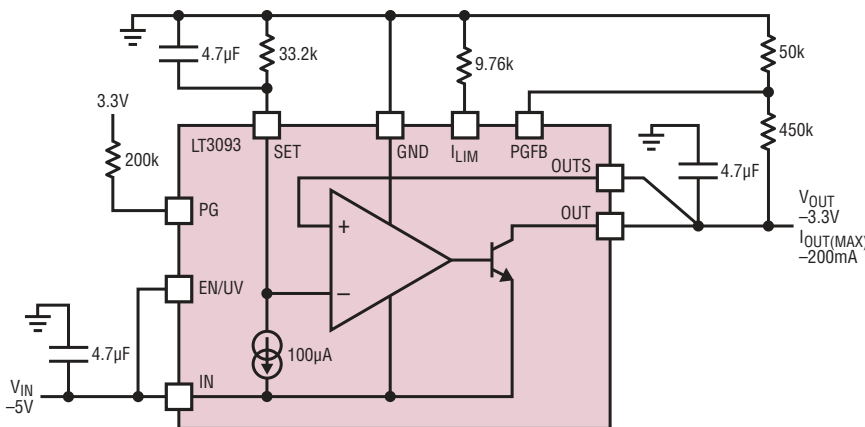

PIN NOT USED IN THIS CIRCUIT: VIOC

3093 TA01a

Power Supply Ripple Rejection

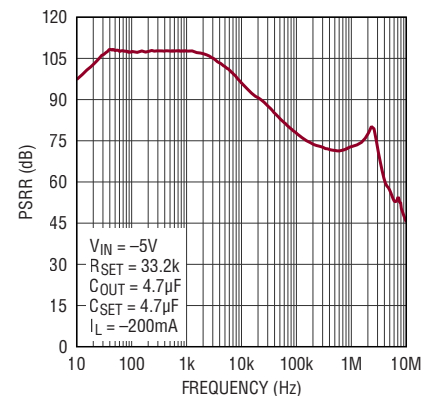

$V_{IN} = -5V$
 $R_{SET} = 33.2k$
 $C_{OUT} = 4.7\mu F$
 $C_{SET} = 4.7\mu F$
 $I_L = -200mA$

3093 TA01b

Rev. 0

TABLE OF CONTENTS

Features	1
Applications	1
Typical Application	1
Description.....	1
Absolute Maximum Ratings	3
Pin Configuration	3
Order Information	4
Electrical Characteristics	4
Typical Performance Characteristics	7
Pin Functions	15
Block Diagram	16
Applications Information	17
Typical Application	29
Package Description	30
Typical Application	32
Related Parts	32

ABSOLUTE MAXIMUM RATINGS (Note 1)

IN Pin Voltage	SET Pin Current (Note 4)	±10mA
with Respect to GND Pin	OUTS Pin Voltage	
-22V, 0.3V	with Respect to IN Pin (Note 2)	-0.3V, 22V
EN/UV Pin Voltage	with Respect to GND Pin	±22V
with Respect to IN Pin (Note 2)	OUTS Pin Current (Note 4).....	±10mA
-0.3V, 30V	SET-to-OUTS Differential (Note 5)	±22V
with Respect to GND Pin	OUT Pin Voltage	
±22V	with Respect to IN Pin (Note 2)	-0.3V, 22V
PG Pin Voltage	with Respect to GND Pin	±22V
with Respect to IN Pin (Note 2)	OUT-to-OUTS Differential (Note 6).....	±22V
-0.3V, 30V	Output Short-Circuit Duration	Indefinite
with Respect to GND Pin	Operating Junction Temperature Range (Note 3)	
±22V	E-, I-Grades	-40°C to 125°C
PGFB Pin Voltage	H-Grade	-40°C to 150°C
with Respect to IN Pin (Note 2)	Storage Temperature Range	-65°C to 150°C
-0.3V, 30V	Lead Temperature (Soldering, 10 sec)	
with Respect to GND Pin	MSE Package Only.....	300°C
±22V		
I_{LIM} Pin Voltage		
with Respect to IN Pin (Note 2)		
-0.3V, 22V		
VIOC Pin Voltage		
with Respect to IN Pin (Note 2)		
-0.3V, 22V		
with Respect to GND Pin		
-22V, 0.3V		
SET Pin Voltage		
with Respect to IN Pin (Note 2)		
-0.3V, 22V		
with Respect to GND Pin		
±22V		

PIN CONFIGURATION

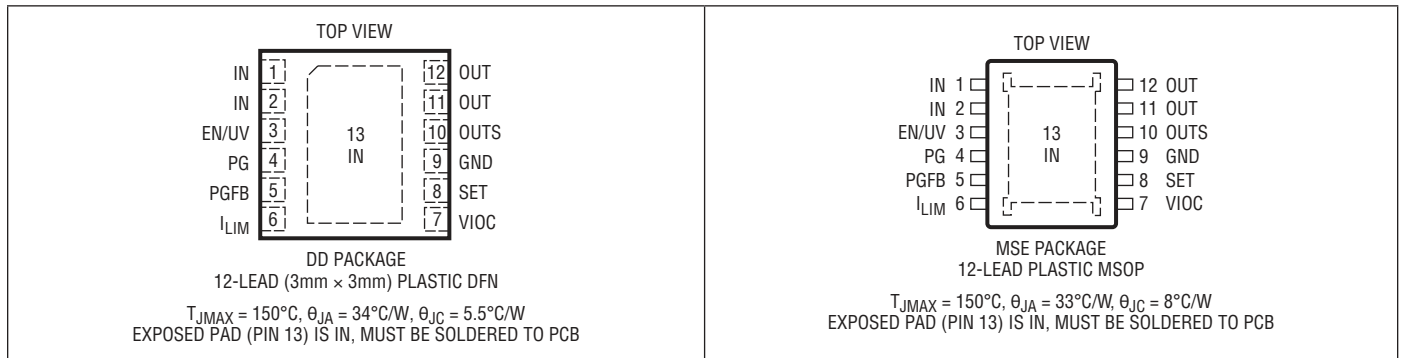

ORDER INFORMATION

LEAD FREE FINISH	TAPE AND REEL	PART MARKING*	PACKAGE DESCRIPTION	TEMPERATURE RANGE
LT3093EDD#PBF	LT3093EDD#TRPBF	LHJQ	12-Lead (3mm × 3mm) Plastic DFN	-40°C to 125°C
LT3093IDD#PBF	LT3093IDD#TRPBF	LHJQ	12-Lead (3mm × 3mm) Plastic DFN	-40°C to 125°C
LT3093HDD#PBF	LT3093HDD#TRPBF	LHJQ	12-Lead (3mm × 3mm) Plastic DFN	-40°C to 150°C
LT3093EMSE#PBF	LT3093EMSE#TRPBF	3093	12-Lead Plastic MSOP	-40°C to 125°C
LT3093IMSE#PBF	LT3093IMSE#TRPBF	3093	12-Lead Plastic MSOP	-40°C to 125°C
LT3093HMSE#PBF	LT3093HMSE#TRPBF	3093	12-Lead Plastic MSOP	-40°C to 150°C

Contact the factory for parts specified with wider operating temperature ranges. *The temperature grade is identified by a label on the shipping container.

[Tape and reel specifications.](#) Some packages are available in 500 unit reels through designated sales channels with #TRMPBF suffix.

ELECTRICAL CHARACTERISTICS

The ● denotes the specifications which apply over the full operating temperature range, otherwise specifications are at $T_A = 25^\circ\text{C}$. (Note 3)

PARAMETER	CONDITIONS	MIN	TYP	MAX	UNITS
Input Voltage Range	$I_{LOAD} = -200\text{mA}$	● -20		-2.3	V
Minimum IN Pin Voltage (Note 8)	$I_{LOAD} = -200\text{mA}$, V_{IN} UVLO Rising V_{IN} UVLO Hysteresis	● -2.3	-1.8 130		V mV
SET Pin Current (I_{SET})	$V_{IN} = -2.3\text{V}$, $I_{LOAD} = 1\text{mA}$, $V_{OUT} = -1.5\text{V}$ $-20\text{V} < V_{IN} < -2.3\text{V}$, $-19.5\text{V} < V_{OUT} < 0\text{V}$, $-1\text{mA} > I_{LOAD} > -200\text{mA}$ (Note 7)	● 99	100	101	μA μA
Fast Start-Up SET Pin Current	$V_{PGFB} = -286\text{mV}$, $V_{IN} = -2.3\text{V}$, $V_{SET} = -1.5\text{V}$		1.8		mA
Output Offset Voltage V_{OS} ($V_{OUT} - V_{SET}$) (Note 9)	$V_{IN} = -2.3\text{V}$, $I_{LOAD} = 1\text{mA}$, $V_{OUT} = -1.5\text{V}$ $-20\text{V} < V_{IN} < -2.3\text{V}$, $-19.5\text{V} < V_{OUT} < 0\text{V}$, $-1\text{mA} > I_{LOAD} > -200\text{mA}$ (Note 7)	● -1 -2		1 2	mV mV
Line Regulation: ΔI_{SET} Line Regulation: ΔV_{OS}	$V_{IN} = -2.3\text{V}$ to -20V , $I_{LOAD} = -1\text{mA}$, $V_{OUT} = -1.5\text{V}$ $V_{IN} = -2.3\text{V}$ to -20V , $I_{LOAD} = -1\text{mA}$, $V_{OUT} = -1.5\text{V}$ (Note 9)	● -5 ● -6	0.5 0.1	5 6	nA/V $\mu\text{V/V}$
Load Regulation: ΔI_{SET} Load Regulation: ΔV_{OS}	$I_{LOAD} = -1\text{mA}$ to -200mA , $V_{IN} = -2.3\text{V}$, $V_{OUT} = -1.5\text{V}$ $I_{LOAD} = -1\text{mA}$ to -200mA , $V_{IN} = -2.3\text{V}$, $V_{OUT} = -1.5\text{V}$ (Note 9)	●	0.1 0.03	0.5	nA mV
Change in I_{SET} with V_{SET} Change in V_{OS} with V_{SET} Change in I_{SET} with V_{SET} Change in V_{OS} with V_{SET}	$V_{SET} = -1.5\text{V}$ to -19.5V , $V_{IN} = -20\text{V}$, $I_{LOAD} = -1\text{mA}$ $V_{SET} = -1.5\text{V}$ to -19.5V , $V_{IN} = -20\text{V}$, $I_{LOAD} = -1\text{mA}$ (Note 9) $V_{SET} = 0\text{V}$ to -1.5V , $V_{IN} = -20\text{V}$, $I_{LOAD} = -1\text{mA}$ $V_{SET} = 0\text{V}$ to -1.5V , $V_{IN} = -20\text{V}$, $I_{LOAD} = -1\text{mA}$ (Note 9)	● ● ● ●	100 0.02 150 0.15	850 0.5 500 2	nA mV nA mV
Dropout Voltage (Note 10)	$I_{LOAD} = -1\text{mA}$, -50mA $I_{LOAD} = -100\text{mA}$ $I_{LOAD} = -200\text{mA}$	● ● ●	185 185	225 275 230 280 240 330	mV mV mV mV
GND Pin Current $V_{IN} = V_{OUT(\text{NOMINAL})}$ (Note 11)	$I_{LOAD} = -10\mu\text{A}$ $I_{LOAD} = -1\text{mA}$ $I_{LOAD} = -50\text{mA}$ $I_{LOAD} = -100\text{mA}$ $I_{LOAD} = -200\text{mA}$	● ● ● ● ●	2.35 2.4 3.1 3.8 7	4 5.5 6.5 15	mA mA mA mA mA
Output Noise Spectral Density (Notes 9, 12)	$I_{LOAD} = -200\text{mA}$, Frequency = 10Hz, $C_{OUT} = 4.7\mu\text{F}$, $C_{SET} = 0.47\mu\text{F}$, $V_{OUT} = -3.3\text{V}$ $I_{LOAD} = -200\text{mA}$, Frequency = 10Hz, $C_{OUT} = 4.7\mu\text{F}$, $C_{SET} = 4.7\mu\text{F}$, $-19.5\text{V} \leq V_{OUT} \leq -1.5\text{V}$ $I_{LOAD} = -200\text{mA}$, Frequency = 10kHz, $C_{OUT} = 4.7\mu\text{F}$, $C_{SET} = 0.47\mu\text{F}$, $-19.5\text{V} \leq V_{OUT} \leq -1.5\text{V}$ $I_{LOAD} = -200\text{mA}$, Frequency = 10kHz, $C_{OUT} = 4.7\mu\text{F}$, $C_{SET} = 0.47\mu\text{F}$, $-1.5\text{V} \leq V_{OUT} \leq 0\text{V}$		700 70 2.2 6		$\text{nV}/\sqrt{\text{Hz}}$ $\text{nV}/\sqrt{\text{Hz}}$ $\text{nV}/\sqrt{\text{Hz}}$ $\text{nV}/\sqrt{\text{Hz}}$
Output RMS Noise (Notes 9, 12)	$I_{LOAD} = -200\text{mA}$, BW = 10Hz to 100kHz, $C_{OUT} = 4.7\mu\text{F}$, $C_{SET} = 0.47\mu\text{F}$, $V_{OUT} = -3.3\text{V}$ $I_{LOAD} = -200\text{mA}$, BW = 10Hz to 100kHz, $C_{OUT} = 4.7\mu\text{F}$, $C_{SET} = 4.7\mu\text{F}$, $-19.5\text{V} \leq V_{OUT} \leq -1.5\text{V}$ $I_{LOAD} = -200\text{mA}$, BW = 10Hz to 100kHz, $C_{OUT} = 4.7\mu\text{F}$, $C_{SET} = 4.7\mu\text{F}$, $-1.5\text{V} \leq V_{OUT} \leq 0\text{V}$		3 0.8 1.8		μV_{RMS} μV_{RMS} μV_{RMS}

ELECTRICAL CHARACTERISTICS The ● denotes the specifications which apply over the full operating temperature range, otherwise specifications are at T_A = 25°C. (Note 3)

PARAMETER	CONDITIONS	MIN	TYP	MAX	UNITS
Reference Current RMS Output Noise (Notes 9, 12)	BW = 10Hz to 100kHz		8		nA _{RMS}
Ripple Rejection -18V ≤ V _{OUT} ≤ -1.5V V _{IN} - V _{OUT} = 2V (Avg) (Notes 9, 12)	V _{RIPPLE} = 500mV _{P-P} , f _{RIPPLE} = 120Hz, I _{LOAD} = -200mA, C _{OUT} = 4.7μF, C _{SET} = 4.7μF V _{RIPPLE} = 500mV _{P-P} , f _{RIPPLE} = 10kHz, I _{LOAD} = -200mA, C _{OUT} = 4.7μF, C _{SET} = 0.47μF V _{RIPPLE} = 500mV _{P-P} , f _{RIPPLE} = 100kHz, I _{LOAD} = -200mA, C _{OUT} = 4.7μF, C _{SET} = 0.47μF V _{RIPPLE} = 500mV _{P-P} , f _{RIPPLE} = 1MHz, I _{LOAD} = -200mA, C _{OUT} = 4.7μF, C _{SET} = 0.47μF V _{RIPPLE} = 500mV _{P-P} , f _{RIPPLE} = 10MHz, I _{LOAD} = -200mA, C _{OUT} = 4.7μF, C _{SET} = 0.47μF		108 94 75 74 45		dB dB dB dB dB
Ripple Rejection -1.5V ≤ V _{OUT} ≤ 0V V _{IN} - V _{OUT} = 2V (Avg) (Notes 9, 12)	V _{RIPPLE} = 500mV _{P-P} , f _{RIPPLE} = 120Hz, I _{LOAD} = -200mA, C _{OUT} = 4.7μF, C _{SET} = 4.7μF V _{RIPPLE} = 500mV _{P-P} , f _{RIPPLE} = 10kHz, I _{LOAD} = -200mA, C _{OUT} = 4.7μF, C _{SET} = 0.47μF V _{RIPPLE} = 500mV _{P-P} , f _{RIPPLE} = 100kHz, I _{LOAD} = -200mA, C _{OUT} = 4.7μF, C _{SET} = 0.47μF V _{RIPPLE} = 500mV _{P-P} , f _{RIPPLE} = 1MHz, I _{LOAD} = -200mA, C _{OUT} = 4.7μF, C _{SET} = 0.47μF V _{RIPPLE} = 500mV _{P-P} , f _{RIPPLE} = 10MHz, I _{LOAD} = -200mA, C _{OUT} = 4.7μF, C _{SET} = 0.47μF		108 90 72 78 45		dB dB dB dB dB
EN/UV Pin Threshold	Positive EN/UV Trip Point Rising (Turn-On), V _{IN} = -2.3V Negative EN/UV Trip Point Rising (Turn-On), V _{IN} = -2.3V	● 1.20 ● -1.33	1.26 -1.26	1.35 -1.20	V V
EN/UV Pin Hysteresis	Positive EN/UV Trip Point Hysteresis, V _{IN} = -2.3V Negative EN/UV Trip Point Hysteresis, V _{IN} = -2.3V		200 215		mV mV
EN/UV Pin Current	V _{EN/UV} = 0V, V _{IN} = -20V V _{EN/UV} = -1.5V, V _{IN} = -20V V _{EN/UV} = -20V, V _{IN} = -20V V _{EN/UV} = 1.5V, V _{IN} = -20V V _{EN/UV} = 20V, V _{IN} = 0V	● -1 ● -35 ● 25	-0.5 -18.5 8 45	1	μA μA μA μA μA
Quiescent Current in Shutdown (V _{EN/UV} = 0V)	V _{IN} = -6V, V _{PG} = Open	●	3	8 10	μA μA
Internal Current Limit (Note 14)	V _{IN} = -2.3V, V _{OUT} = 0V V _{IN} = -12V, V _{OUT} = 0V V _{IN} = -20V, V _{OUT} = 0V	● 220 ● 20	400 240 50		mA mA mA
Programmable Current Limit	Programming Scale Factor: -20V < V _{IN} < -2.3V (Note 13) V _{IN} = -2.3V, V _{OUT} = 0V, R _{ILIM} = 7.5kΩ V _{IN} = -2.3V, V _{OUT} = 0V, R _{ILIM} = 37.5kΩ	● 1.95 ● 260 ● 55			A • kΩ mA mA
PGFB Trip Point	PGFB Trip Point Rising	● 288	300	312	mV
PGFB Hysteresis	PGFB Trip Point Hysteresis		7		mV
PGFB Pin Current	V _{IN} = -2.3V, V _{PGFB} = -300mV		30	100	nA
PG Output Low Voltage	I _{PG} = 100μA	●	17	50	mV
PG Leakage Current	V _{PG} = 20V	●		1	μA
VIOC Amplifier Gain	-20V ≤ V _{IN} ≤ -2.3V, V _{OUT} ≤ -1.5V		1		V/V
VIOC Sink Current	V _{IN} - V _{OUT} = -2V, V _{VIOC} = -1V	● 100			μA
VIOC Voltage for Low Output Voltages (Note 15)	V _{IN} = -2.3V, V _{OUT} > -1.5V		-0.8		V
Minimum Load Current (Note 16)	V _{OUT} > -1.5V	●		10	μA
Thermal Shutdown	T _J Rising Hysteresis		167 8		°C °C
Start-Up Time	R _{SET} = 49.9k, V _{OUT(NOM)} = -5V, I _{LOAD} = -200mA, C _{SET} = 0.47μF, V _{IN} = -6V, V _{PGFB} = -6V R _{SET} = 49.9k, V _{OUT(NOM)} = -5V, I _{LOAD} = -200mA, C _{SET} = 4.7μF, V _{IN} = -6V, V _{PGFB} = -6V R _{SET} = 49.9k, V _{OUT(NOM)} = -5V, I _{LOAD} = -200mA, C _{SET} = 4.7μF, V _{IN} = -6V, R _{PG1} = 50kΩ, R _{PG2} = 700kΩ (with Fast Start-Up to 90% of V _{OUT})		55 550 10		ms ms ms
Thermal Regulation	10ms Pulse		-0.01		%/W

ELECTRICAL CHARACTERISTICS

Note 1: Stresses beyond those listed under Absolute Maximum Ratings may cause permanent damage to the device. Exposure to any Absolute Maximum Rating condition for extended periods may affect device reliability and lifetime.

Note 2: Parasitic diodes exist internally between the EN/UV, I_{LIM} , PG, PGFB, SET, GND, VIOC, OUTS and OUT pins and the IN pin. Do not drive these pins more than 0.3V below the IN pin during a fault condition. These pins must remain at a voltage more positive than IN during normal operation.

Note 3: The LT3093 is tested and specified under pulse load conditions such that $T_J \approx T_A$. The LT3093E is tested at $T_A = 25^\circ\text{C}$ and performance is guaranteed from 0°C to 125°C . Performance of the LT3093E over the full -40°C and 125°C operating temperature range is assured by design, characterization, and correlation with statistical process controls. The LT3093I is guaranteed over the full -40°C to 125°C operating junction temperature range. The LT3093H is 100% tested at the 150°C operating temperature. High junction temperatures degrade operating lifetimes. Operating lifetime is derated at junction temperatures greater than 125°C .

Note 4: SET and OUTS pins are clamped using diodes and two 400Ω series resistors. For less than 5ms transients, this clamp circuitry can carry more than the rated current.

Note 5: Maximum SET and OUTS pin current requirement must be satisfied.

Note 6: Maximum OUT-to-OUTS differential is guaranteed by design.

Note 7: Maximum junction temperature limits operating conditions. The regulated output voltage specification does not apply for all possible combinations of input voltage and output current, especially due to the internal current limit foldback which starts to decrease current limit at $V_{OUT} - V_{IN} > 7\text{V}$. If operating at maximum output current, limit the input voltage range. If operating at maximum input voltage, limit the output current range.

Note 8: The EN/UV pin threshold must be met to ensure device operation.

Note 9: OUTS ties directly to OUT.

Note 10: Dropout voltage is the minimum input-to-output differential voltage needed to maintain regulation at a specified output current. The dropout voltage is measured when output is 1% out of regulation. This definition results in a higher dropout voltage compared to hard dropout—which is measured when $V_{IN} = V_{OUT(NOMINAL)}$. For output voltages between 0V and -1.8V , dropout voltage is limited by the minimum input voltage specification.

Note 11: GND pin current is tested with $V_{IN} = V_{OUT(NOMINAL)}$ and a current source load. Therefore, the device is tested while operating in dropout. This is the worst-case GND pin current. GND pin current decreases at higher input voltages. Note that GND pin current does not include SET pin or I_{LIM} pin current, but they are included in quiescent current.

Note 12: Adding a capacitor across the SET pin resistor decreases output voltage noise. Adding this capacitor bypasses the SET pin resistor's thermal noise as well as the reference current's noise. The output noise then equals the error amplifier noise. Use of a SET pin bypass capacitor also increases start-up time.

Note 13: The current limit programming scale factor is specified while the internal backup current limit is not active. Note that the internal current limit has foldback protection for $V_{OUT} - V_{IN}$ differentials greater than 7V.

Note 14: The internal backup current limit circuitry incorporates foldback protection that decreases current limit for $V_{OUT} - V_{IN} > 7\text{V}$. Some level of output current is provided at all $V_{OUT} - V_{IN}$ differential voltages. Consult the Typical Performance Characteristics graph for current limit vs $V_{IN} - V_{OUT}$.

Note 15: The VIOC amplifier outputs a voltage equal to $V_{IN} - V_{OUT}$ or $V_{IN} + 1.5\text{V}$ (when V_{OUT} is between 0V and -1.5V). See Block Diagram and Applications Information for further information.

Note 16: For output voltages between 0V and -1.5V , the LT3093 requires a $10\mu\text{A}$ minimum load current for stability.

TYPICAL PERFORMANCE CHARACTERISTICS $T_A = 25^\circ\text{C}$, unless otherwise noted.

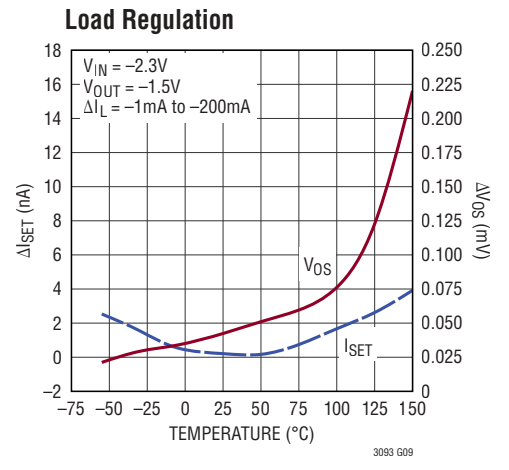
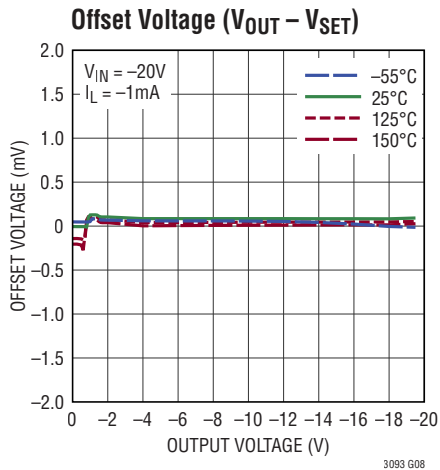
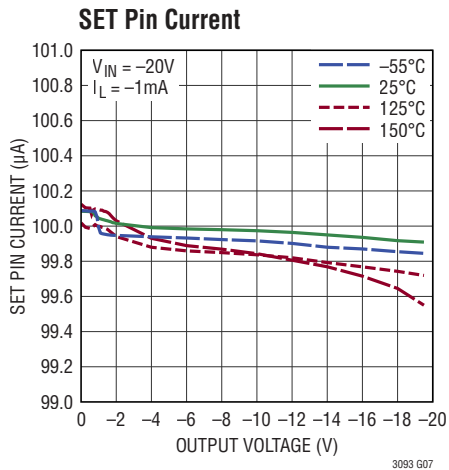
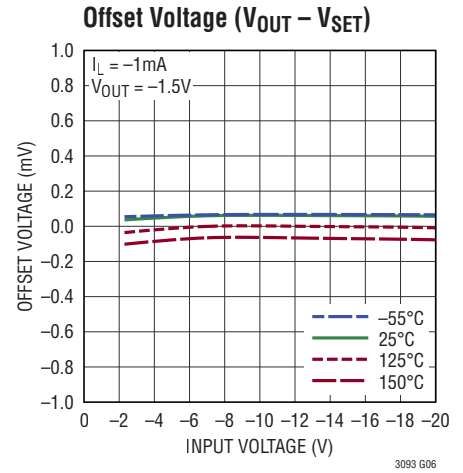
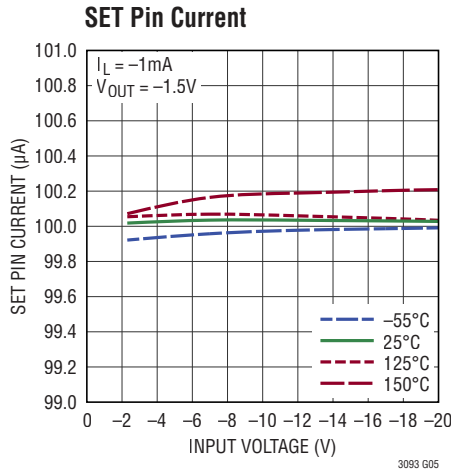
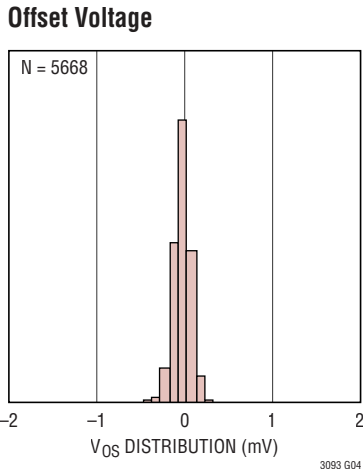
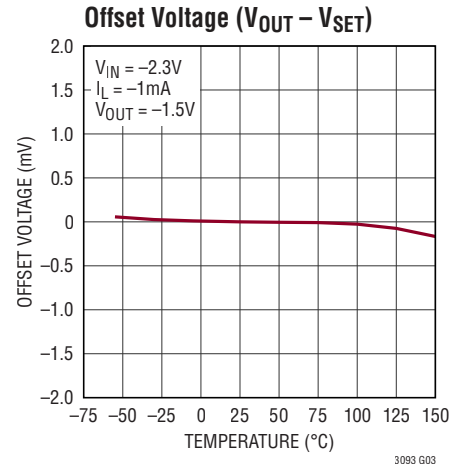
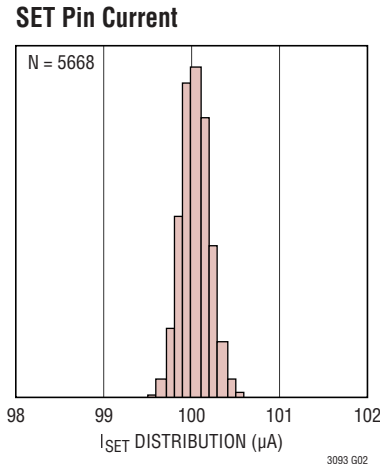
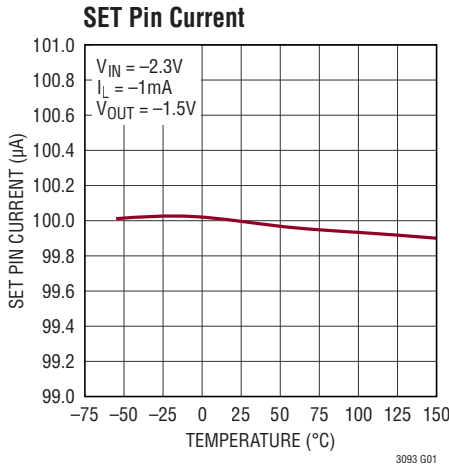

TYPICAL PERFORMANCE CHARACTERISTICS $T_A = 25^\circ\text{C}$, unless otherwise noted.

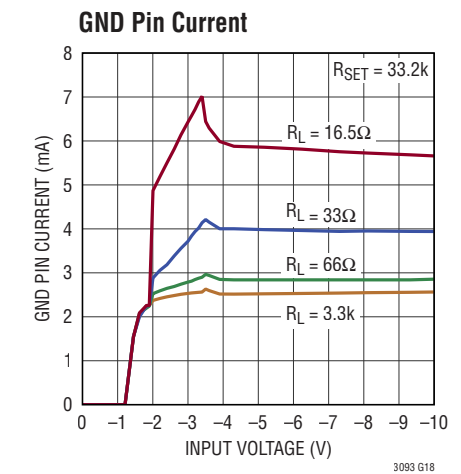
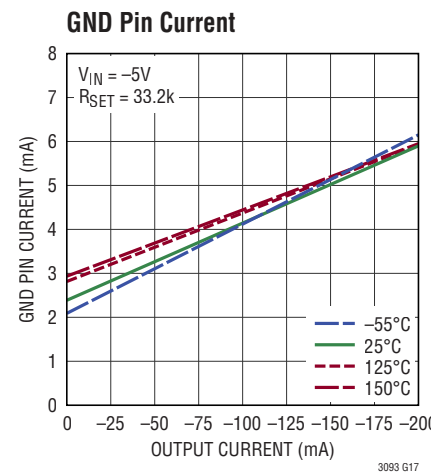
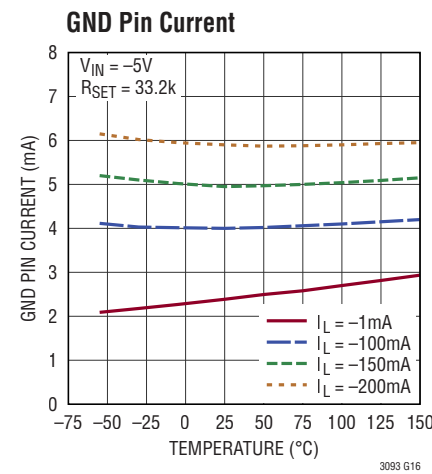
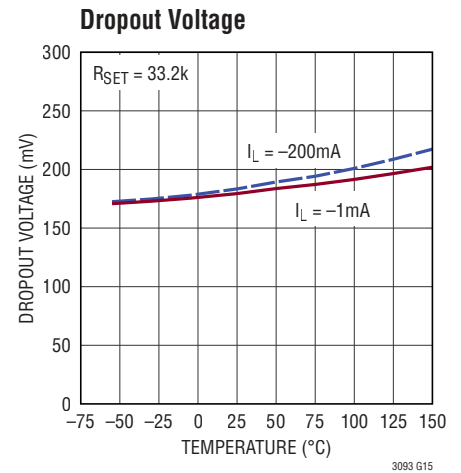
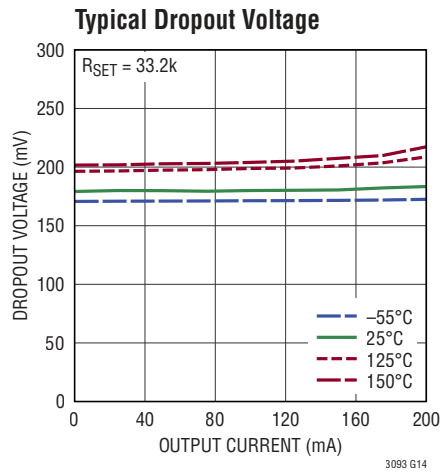
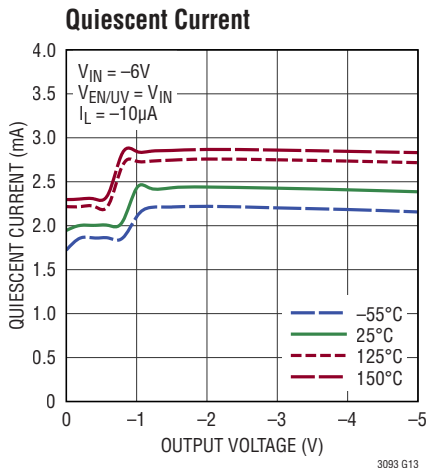
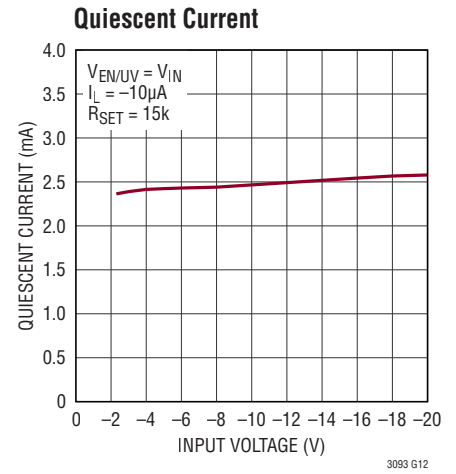
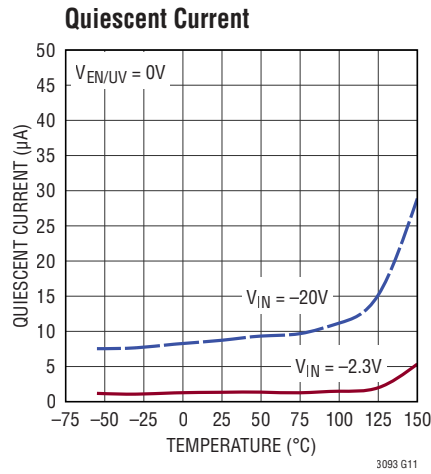
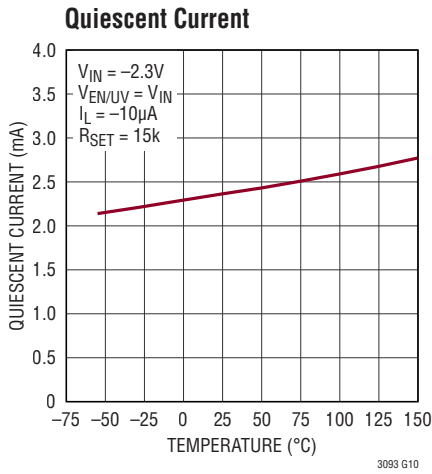

TYPICAL PERFORMANCE CHARACTERISTICS $T_A = 25^\circ\text{C}$, unless otherwise noted.

Minimum Input Voltage

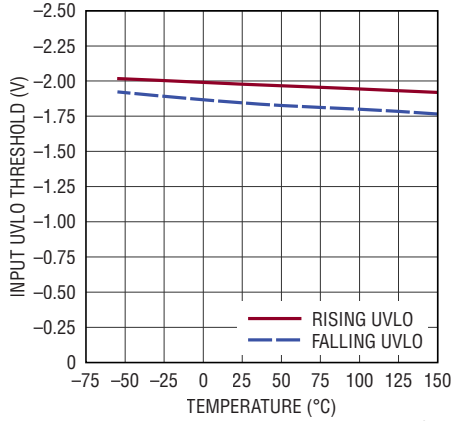

3093 G19

Negative EN/UV Turn-On Threshold

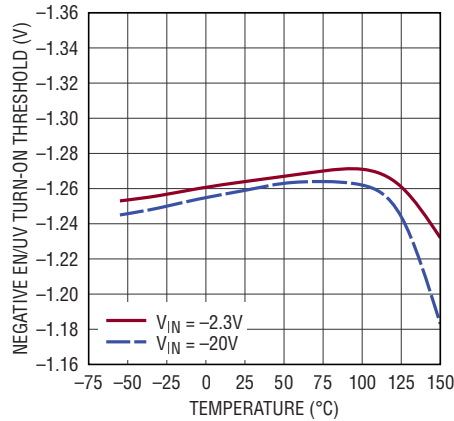

3093 G20

Positive EN/UV Turn-On Threshold

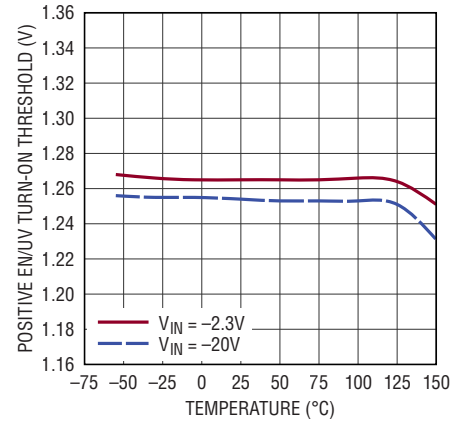

3093 G21

EN/UV Pin Hysteresis

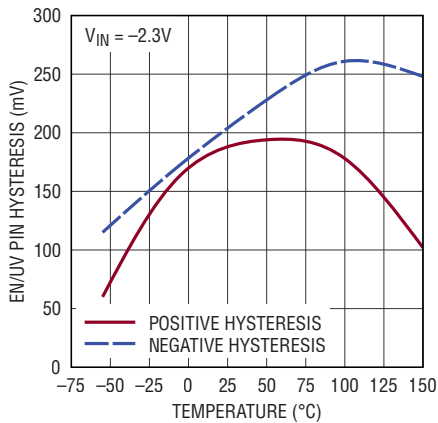

3093 G22

EN/UV Pin Current

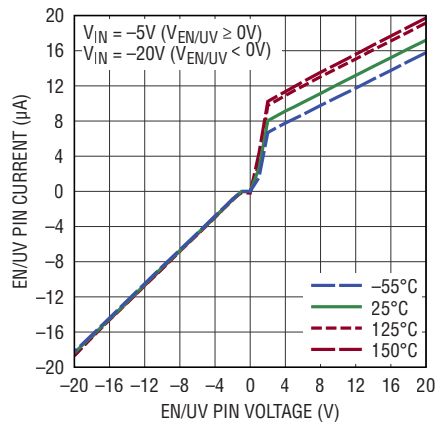

3093 G23

Internal Current Limit

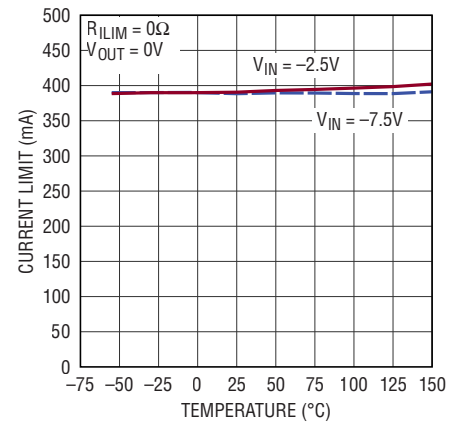

3093 G24

Internal Current Limit

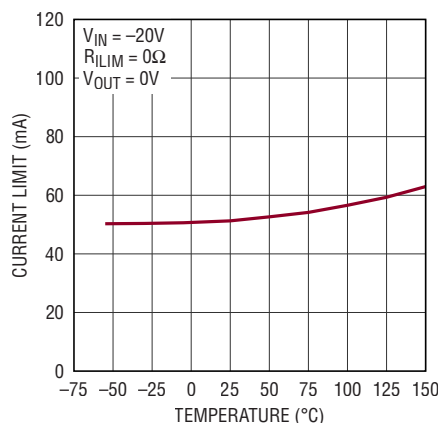

3093 G25

Internal Current Limit

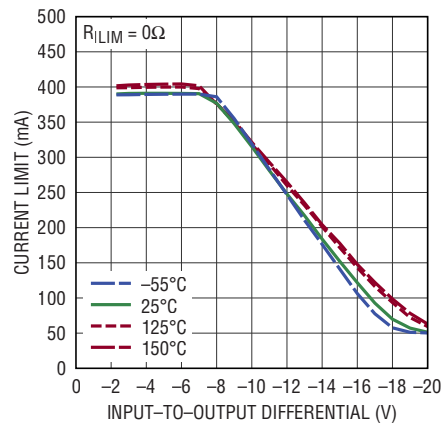

3093 G26

Programmable Current Limit

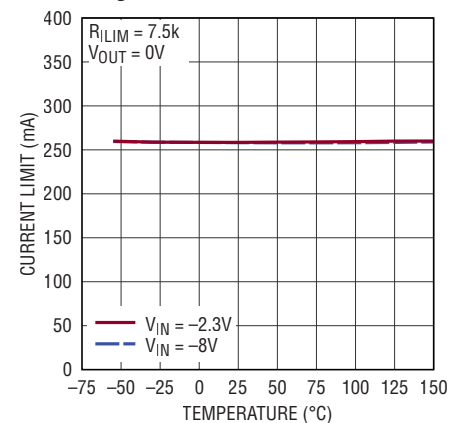

3093 G27

TYPICAL PERFORMANCE CHARACTERISTICS $T_A = 25^\circ\text{C}$, unless otherwise noted.

Programmable Current Limit

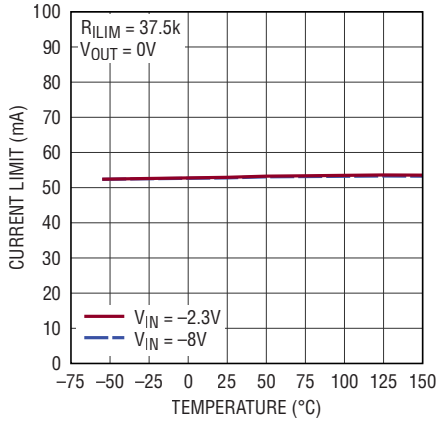

3093 G28

I_{LIM} Pin Voltage

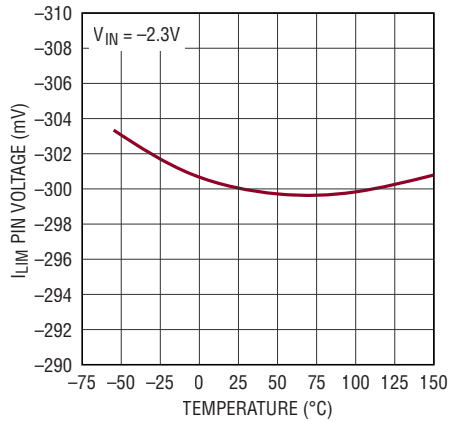

3093 G29

I_{LIM} Pin Current

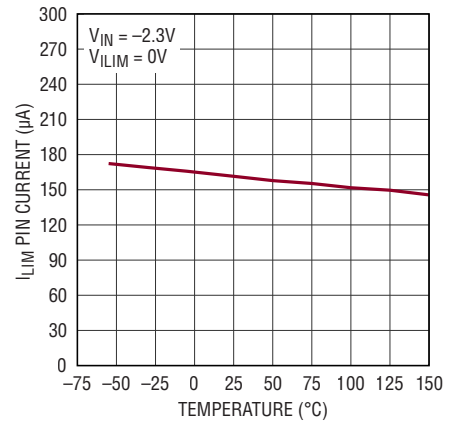

3093 G30

PGFB Rising Threshold

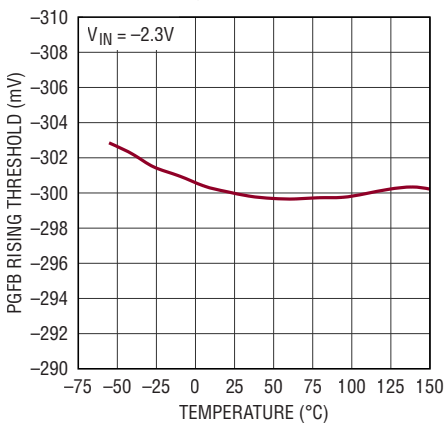

3093 G31

PGFB Hysteresis

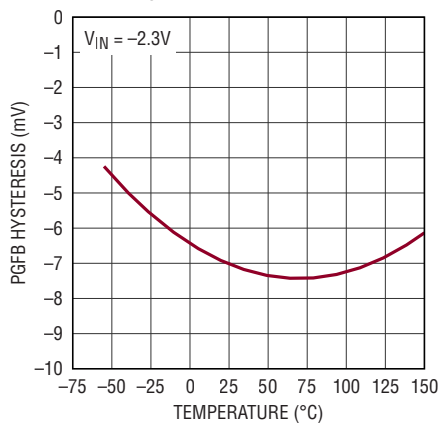

3093 G32

PG Output Low Voltage

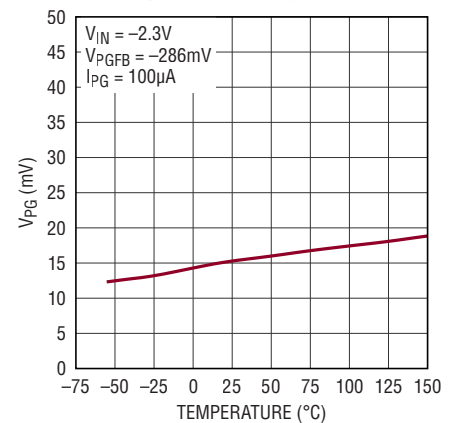

3093 G33

PG Pin Leakage Current

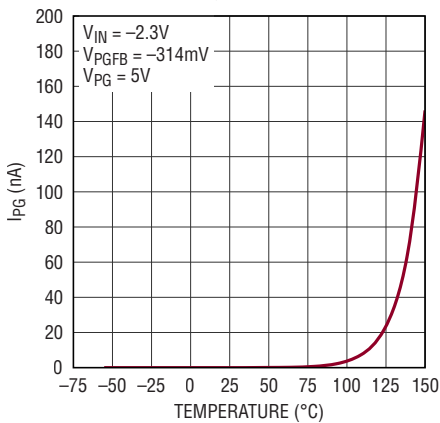

3093 G34

I_{SET} During Start-Up with Fast Start-Up Enabled

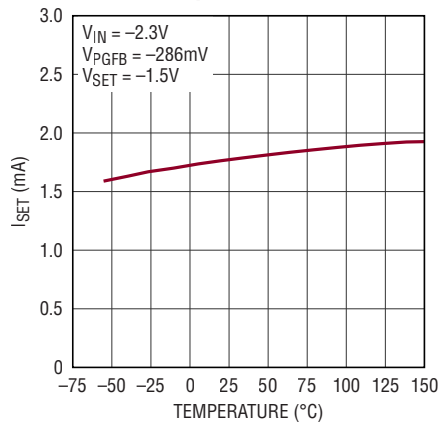

3093 G35

I_{SET} During Start-Up with Fast Start-Up Enabled

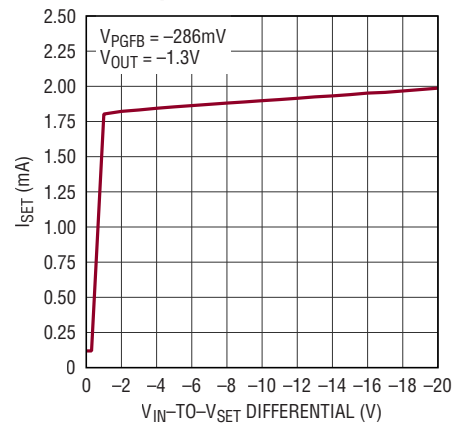

3093 G36

TYPICAL PERFORMANCE CHARACTERISTICS $T_A = 25^\circ\text{C}$, unless otherwise noted.

Output Overshoot Recovery Source Current

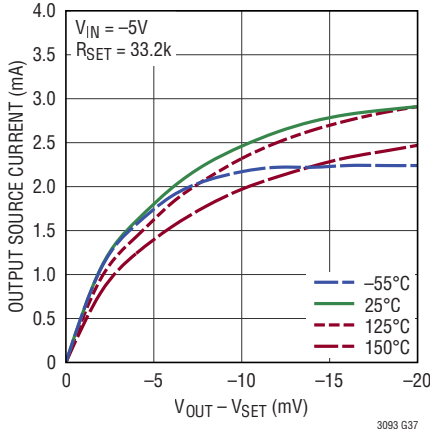

3093 G37

Output Overshoot Recovery Source Current

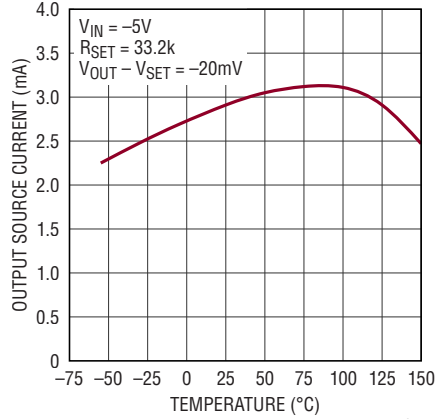

3093 G38

VIOC Voltage

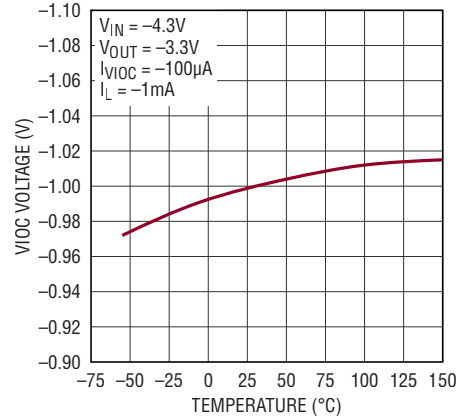

3093 G39

VIOC Voltage

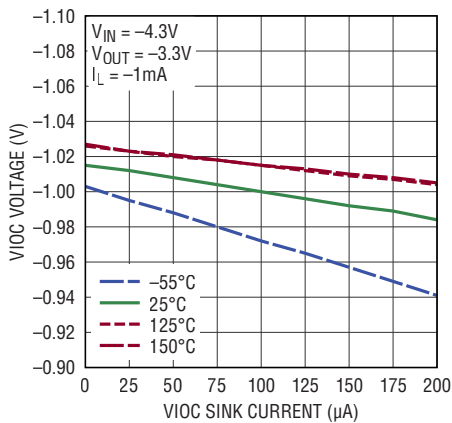

3093 G40

VIOC Source Current

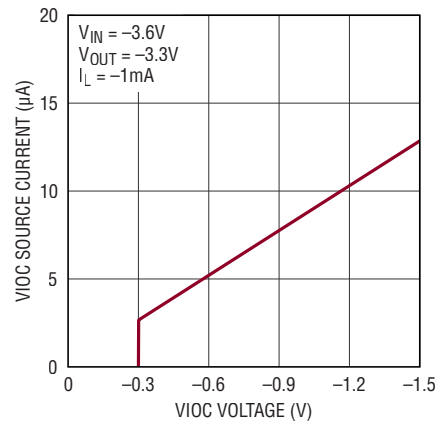

3093 G41

Power Supply Ripple Rejection

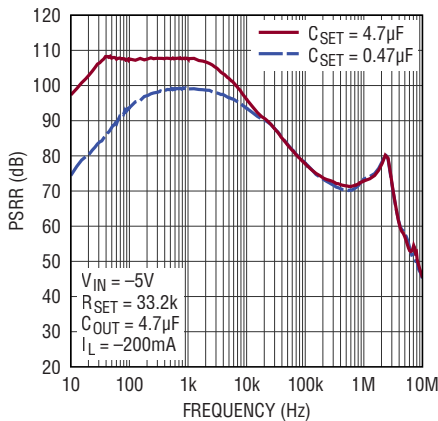

3093 G42

Power Supply Ripple Rejection

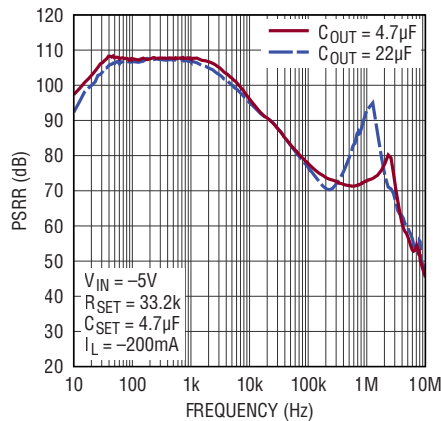

3093 G43

Power Supply Ripple Rejection

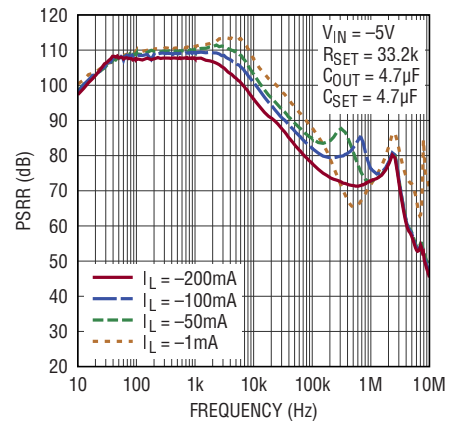

3093 G44

TYPICAL PERFORMANCE CHARACTERISTICS $T_A = 25^\circ\text{C}$, unless otherwise noted.

Power Supply Ripple Rejection as a Function of Error Amplifier Input Pair

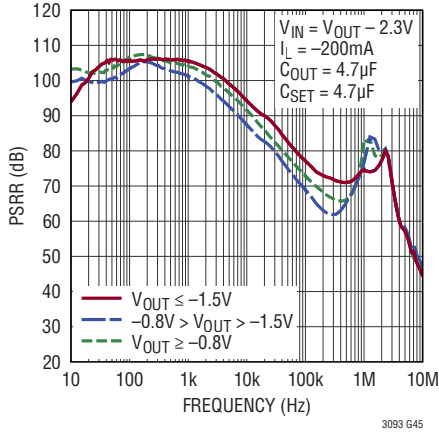

Power Supply Ripple Rejection

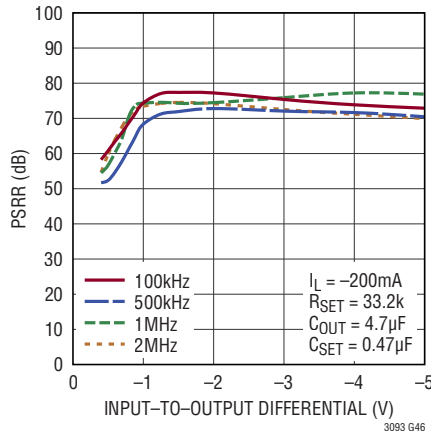

Integrated RMS Output Noise (10Hz to 100kHz)

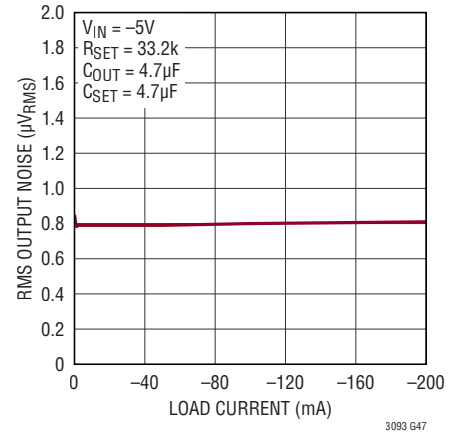

Integrated RMS Output Noise (10Hz to 100kHz)

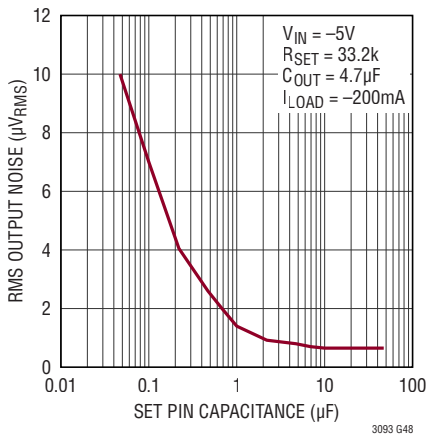

Integrated RMS Output Noise (10Hz to 100kHz)

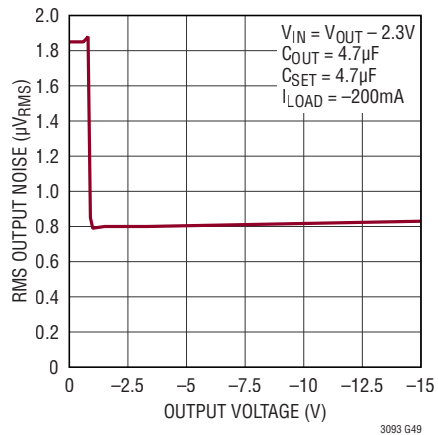

Noise Spectral Density

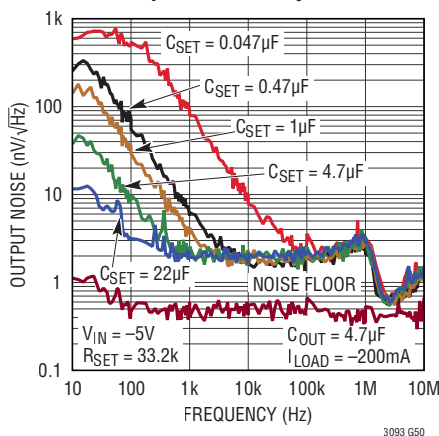

Noise Spectral Density

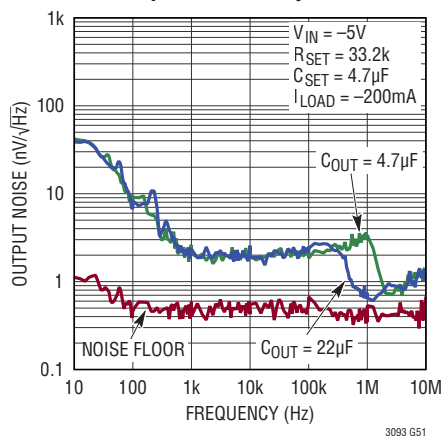

TYPICAL PERFORMANCE CHARACTERISTICS $T_A = 25^\circ\text{C}$, unless otherwise noted.

Noise Spectral Density

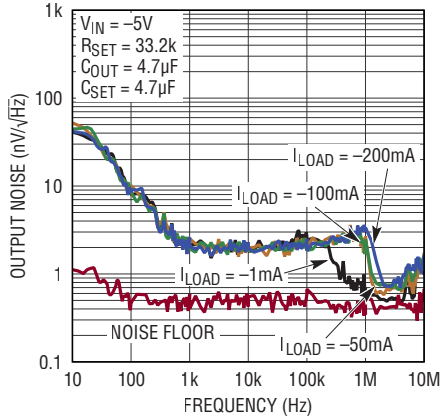

Noise Spectral Density as a Function of Error Amplifier Input Pair

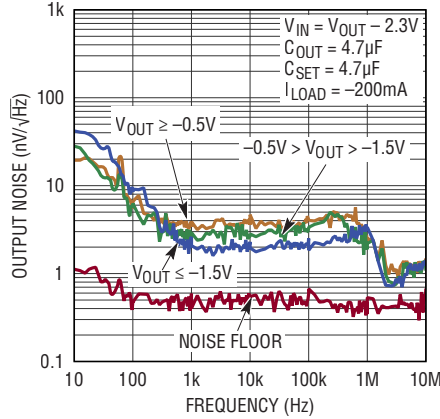

Noise Spectral Density (0.1Hz to 10Hz)

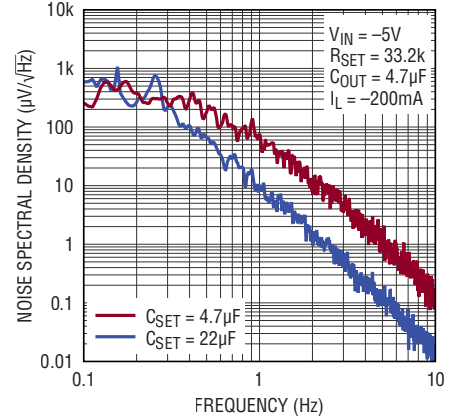

Output Noise (10Hz to 100kHz)

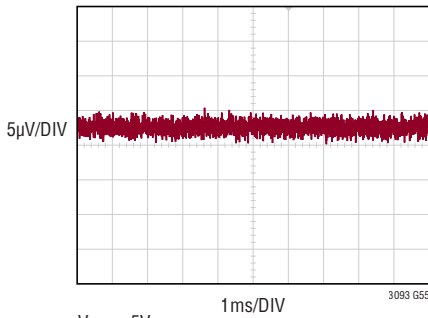

$V_{IN} = -5\text{V}$
 $R_{SET} = 33.2\text{k}$
 $C_{OUT} = 4.7\mu\text{F}$
 $C_{SET} = 4.7\mu\text{F}$
 $I_{LOAD} = -200\text{mA}$

Output Voltage Noise (0.1Hz to 10Hz)

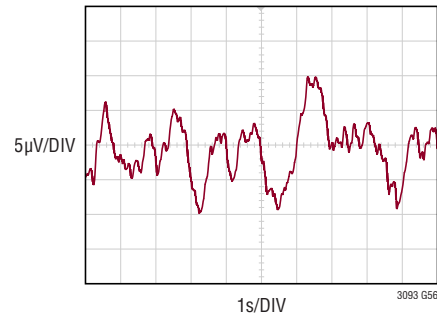

$V_{IN} = -5\text{V}$
 $R_{SET} = 33.2\text{k}$
 $C_{OUT} = 4.7\mu\text{F}$
 $C_{SET} = 4.7\mu\text{F}$
 $I_{LOAD} = -200\text{mA}$

Output Voltage Noise (0.1Hz to 10Hz)

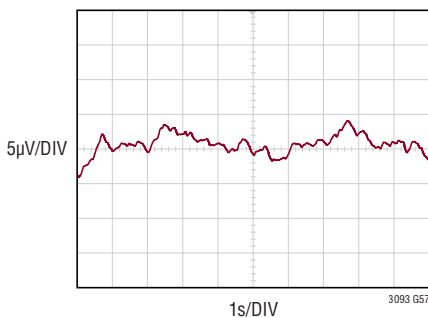

$V_{IN} = -5\text{V}$
 $R_{SET} = 33.2\text{k}$
 $C_{OUT} = 4.7\mu\text{F}$
 $C_{SET} = 22\mu\text{F}$
 $I_{LOAD} = -200\text{mA}$

Load Transient Response

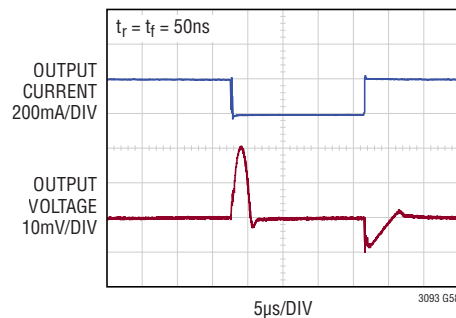

$V_{IN} = -5\text{V}$
 $R_{SET} = 33.2\text{k}$
 $C_{OUT} = 4.7\mu\text{F}$
 $C_{SET} = 4.7\mu\text{F}$
 $\Delta I_L = -10\text{mA TO } -200\text{mA}$

TYPICAL PERFORMANCE CHARACTERISTICS $T_A = 25^\circ\text{C}$, unless otherwise noted.

Line Transient Response

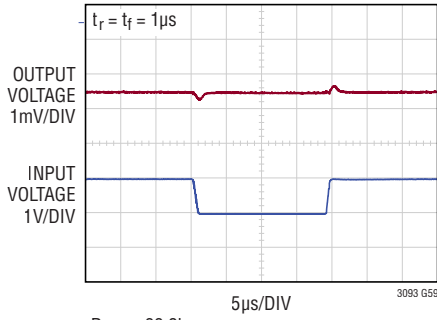

$R_{SET} = 33.2\text{k}$
 $C_{OUT} = 4.7\mu\text{F}$
 $C_{SET} = 4.7\mu\text{F}$
 $\Delta V_{IN} = -4.5\text{V TO } -5.5\text{V}$
 $I_L = -200\text{mA}$

Start-Up Time with and without Fast Start-Up Circuitry for Large C_{SET}

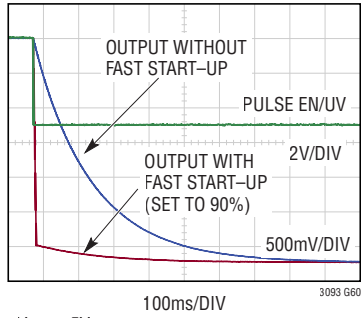

$V_{IN} = -5\text{V}$
 $R_{SET} = 33.2\text{k}$
 $C_{OUT} = 4.7\mu\text{F}$
 $C_{SET} = 4.7\mu\text{F}$
 $R_L = 16.5\Omega$

Input Supply Ramp-Up and Ramp-Down

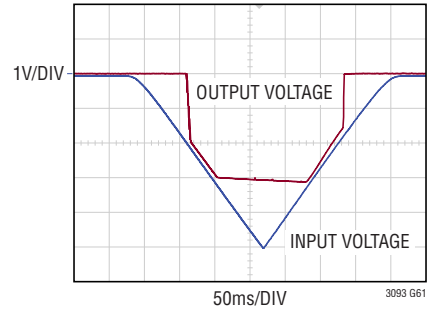

$V_{IN} = 0\text{V TO } -5\text{V}$
 $V_{EN/UV} = V_{IN}$
 $R_{SET} = 33.2\text{k}$
 $C_{OUT} = 4.7\mu\text{F}$
 $C_{SET} = 4.7\mu\text{F}$
 $R_L = 16.5\Omega$

PIN FUNCTIONS

IN (Pins 1, 2, Exposed Pad Pin 13): Input. These pins supply power to the regulator. The LT3093 requires a bypass capacitor at the IN pin. In general, a battery's output impedance rises with frequency, so include a bypass capacitor in battery-powered applications. While a 4.7 μ F input bypass capacitor generally suffices, applications with large load transients may require higher input capacitance to prevent input supply droop. Consult the Applications Information section on the proper use of an input capacitor and its effect on circuit performance.

EN/UV (Pin 3): Enable/UVLO. Pulling the LT3093's EN/UV pin low places the part in shutdown. Quiescent current in shutdown drops to 3 μ A and the output voltage turns off. Alternatively, the EN/UV pin can set an input supply undervoltage lockout (UVLO) threshold using a resistor divider between IN, EN/UV and GND. The EN/UV pin is bidirectional and can be switched with either a positive or negative voltage. The LT3093 typically turns on when the EN/UV voltage exceeds 1.26V above ground (with a 200mV hysteresis on its falling edge) or 1.26V below ground (with a 215mV hysteresis). If unused, tie EN/UV to IN. Do not float the EN/UV pin.

PG (Pin 4): Power Good. PG is an open-collector flag that indicates output voltage regulation. PG pulls low if PGFB is between 0V and -300mV. If the power good functionality is not needed, float the PG pin. The PG flag status is valid even if the LT3093 is in shutdown, with the PG pin being pulled low.

PGFB (Pin 5): Power Good Feedback. The PG pin pulls high if PGFB is below -300mV on its rising edge, with 7mV hysteresis on its falling edge. Connecting an external resistor divider between OUT, PGFB, and GND sets the programmable power good threshold with the following transfer function: $-0.3V \cdot (1 + R_{PG1}/R_{PG2}) - I_{PGFB} \cdot R_{PG1}$. As discussed in the Applications Information section, PGFB also activates the fast start-up circuitry. If power good and fast start-up functionality are not needed, tie PGFB to IN.

I_{LIM} (Pin 6): Current Limit Programming Pin. Connecting a resistor between I_{LIM} and GND programs the current limit. For best accuracy, Kelvin connect this resistor directly to the LT3093's GND pin. The programming scale factor is nominally 1.95A \cdot k Ω . If the programmable current limit

functionality is not needed, tie I_{LIM} to GND. Do not float the I_{LIM} pin.

VIOC (Pin 7): Voltage for Input-to-Output Control. The LT3093 incorporates a tracking feature to control a circuit supplying power to the LT3093 to maintain the differential voltage across the LT3093. This function maximizes efficiency and PSRR performance while minimizing power dissipation. See the Applications Information section for further information. If unused, float the VIOC pin.

SET (Pin 8): Set. This pin is the inverting input of the error amplifier and the regulation setpoint for the LT3093. The SET pin sinks a precision 100 μ A current that flows through an external resistor connected between SET and GND. The LT3093's output voltage is determined by $V_{SET} = I_{SET} \cdot R_{SET}$. Output voltage range is from zero to -19.5V. Adding a capacitor from SET to GND improves noise, PSRR, and transient response at the expense of increased start-up time unless the fast start-up capability is used via the PGFB pin. For optimum load regulation, Kelvin connect the ground side of the SET pin directly to the load.

GND (Pin 9): Ground.

OUTS (Pin 10): Output Sense. This pin is the noninverting input to the error amplifier. For optimal transient performance and load regulation, Kelvin connect OUTS directly to the output capacitor and the load. Also, tie the GND connections of the output capacitor and the SET pin capacitor directly together. Exercise care with regards to placement of input capacitors relative to output capacitors due to potential PSRR degradation from magnetic coupling effects; see the Applications Information section for further information on capacitor placement and board layout. A parasitic substrate diode exists between OUTS and IN pins of the LT3093; do not drive OUTS more than 0.3V below IN during normal operation or a fault condition.

OUT (Pins 11, 12): Output. This pin supplies power to the load. For stability, use a minimum 4.7 μ F output capacitor with an ESR below 30m Ω and an ESL below 1.5nH. Large load transients require larger output capacitance to limit peak voltage transients. Refer to the Applications Information section for more information on output capacitance. A parasitic substrate diode exists between OUT and IN pins of the LT3093; do not drive OUT more than 0.3V below IN during normal operation or during a fault condition.

BLOCK DIAGRAM

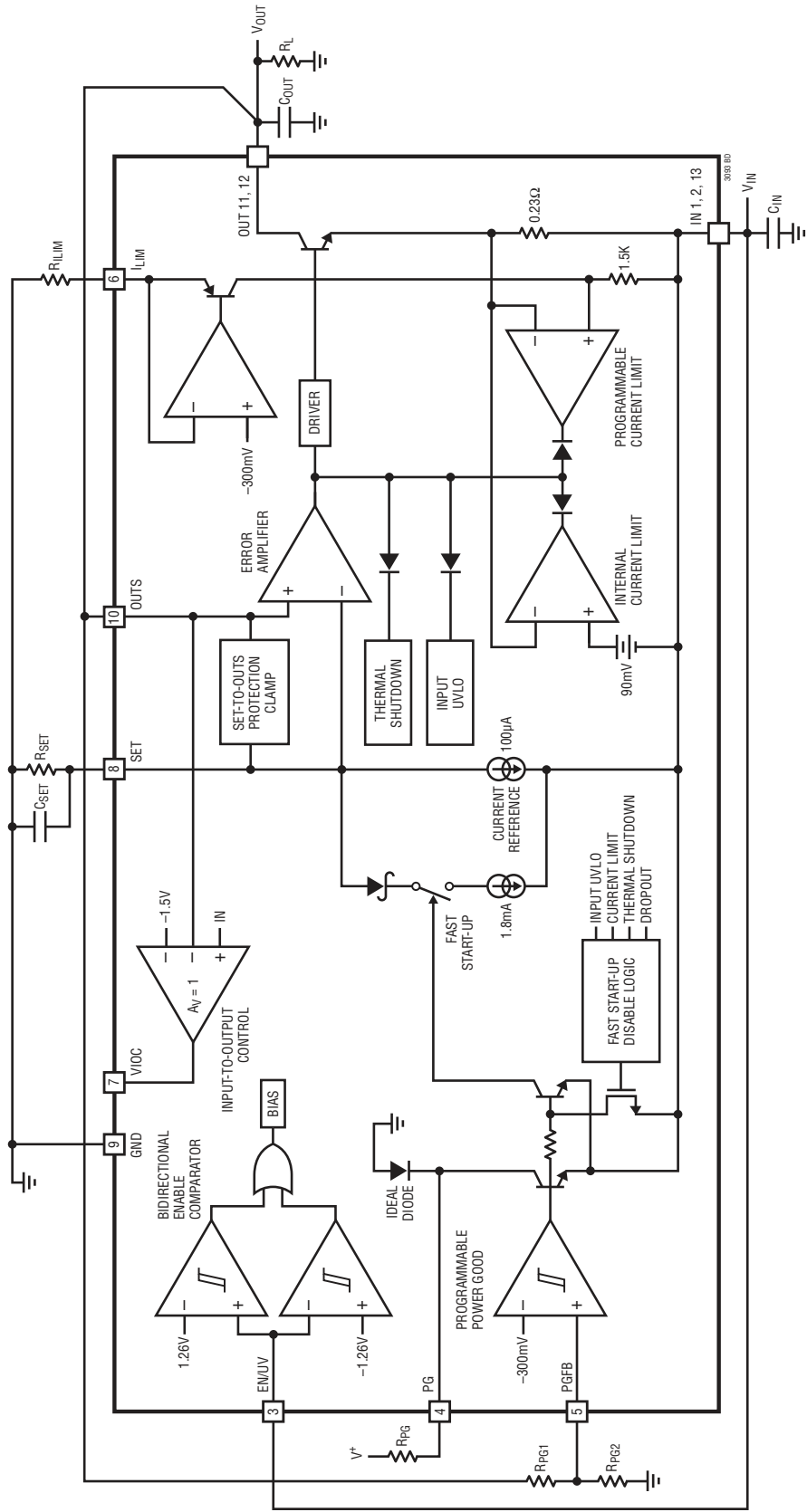

APPLICATIONS INFORMATION

The LT3093 is a high performance low dropout negative linear regulator featuring ADI's ultralow noise ($2.2\text{nV}/\sqrt{\text{Hz}}$ at 10kHz) and ultrahigh PSRR (73dB at 1MHz) architecture for powering noise sensitive applications. Designed as a precision current reference followed by a high performance rail-to-rail voltage buffer, the LT3093 can be easily paralleled to further reduce noise, increase output current and spread heat on the PCB. The device additionally features programmable current limit, fast start-up capability and programmable power good.

The LT3093 is easy to use and incorporates all of the protection features expected in high performance regulators. Included are short-circuit protection, safe operating area protection, and thermal shutdown with hysteresis.

Output Voltage

The LT3093 incorporates a precision $100\mu\text{A}$ current reference flowing into the SET pin, which also ties to the error amplifier's inverting input. Figure 1 illustrates that connecting a resistor from SET to ground generates a reference voltage for the error amplifier. This reference voltage is simply the product of the SET pin current and the SET pin resistor. The error amplifier's unity-gain configuration produces a low impedance version of this voltage on its noninverting input, i.e. the OUTS pin, which is externally tied to the OUT pin. The LT3093's output voltage is determined by $V_{\text{SET}} = I_{\text{SET}} \cdot R_{\text{SET}}$.

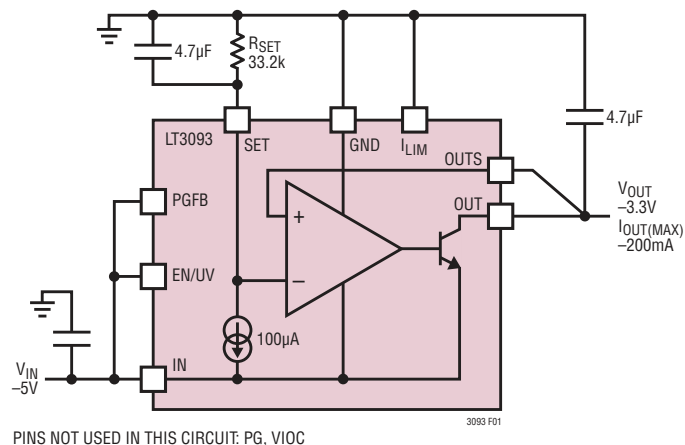

Figure 1. Basic Adjustable Regulator

The LT3093's rail-to-rail error amplifier and current reference architecture allows for a wide output voltage range from 0V (using a 0Ω resistor) to V_{IN} minus dropout. An NPN-based input pair is active for a 0V to -0.8V output and a PNP-based input pair is active for output voltages beyond -1.5V , with a smooth transition between the two input pairs from -0.8V to -1.5V output. The PNP-based input pair offers the best overall performance; refer to the Electrical Characteristics table for details on offset voltage, SET pin current, output noise and PSRR variation depending on the output voltage and corresponding active input pair(s). Table 1 lists common output voltages and their corresponding 1% R_{SET} resistors.

Table 1. 1% Resistor for Common Output Voltages

V_{OUT} (V)	R_{SET} (k Ω)
-2.5	24.9
-3.3	33.2
-5	49.9
-12	121
-15	150

The benefit of using a current reference compared with a voltage reference as used in conventional regulators is that the regulator always operates in a unity-gain configuration, independent of the programmed output voltage. This allows the LT3093 to have loop gain, frequency response and bandwidth independent of the output voltage. As a result, noise, PSRR and transient performance do not change with output voltage. Moreover, since error amplifier gain is not needed to amplify the SET pin voltage to a higher output voltage, output load regulation is more tightly specified in the hundreds of microvolts range and not as a fixed percentage of the output voltage.

Since the zero TC current reference is highly accurate, the SET pin resistor can become the limiting factor in achieving high accuracy. Hence, it should be a precision resistor. Additionally, any leakage paths to or from the SET pin create errors in the output voltage. If necessary, use high quality insulation (e.g. Teflon, Kel-F); moreover, cleaning of all insulating surfaces to remove fluxes and other residues may be required. High humidity environments may require a surface coating at the SET pin to provide a moisture barrier.

APPLICATIONS INFORMATION

Minimize board leakage by encircling the SET pin with a guard ring operated at a similar potential—ideally tied to the OUT pin. Guarding both sides of the circuit board is recommended. Bulk leakage reduction depends on the guard ring width. Leakage of 100nA into or out of the SET pin creates a 0.1% error in the reference voltage. Leakages of this magnitude, coupled with other sources of leakage, can cause significant errors in the output voltage, especially over wide operating temperature ranges. Figure 2 illustrates a typical guard ring layout technique.

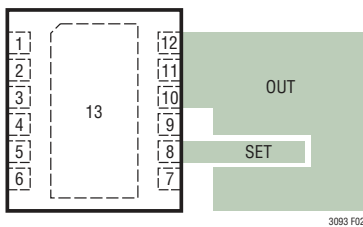

Figure 2. DFN Guard Ring Layout

Since the SET pin is a high impedance node, unwanted signals may couple into the SET pin and cause erratic behavior. This is most noticeable when operating with a minimum output capacitor at heavy load currents. Bypassing the SET pin with a small capacitance to ground resolves this issue—10nF is sufficient.

For applications requiring higher accuracy or an adjustable output voltage, the SET pin may be actively driven by an external voltage source capable of sourcing 100 μ A. Connecting a precision voltage reference to the SET pin eliminates any errors present in the output voltage due to the reference current and SET pin resistor tolerances.

Output Sensing and Stability

The LT3093's OUTS pin provides a Kelvin sense connection to the output. The SET pin resistor's GND side provides a Kelvin sense connection to the load's GND side.

Additionally, for ultrahigh PSRR, the LT3093 bandwidth is made quite high (~1MHz), making it very close to a typical 4.7 μ F (1206 case size) ceramic output capacitor's self-resonance frequency (~2.3MHz). It is very important

to avoid adding extra impedance (ESR and ESL) outside the feedback loop. To that end, minimize the effects of PCB trace and solder inductance by tying the OUTS pin directly to C_{OUT} and the GND side of C_{SET} directly to the GND side of C_{OUT} , as well as keep the GND sides of C_{IN} and C_{OUT} reasonably close, as shown in Figure 3. Refer to the LT3093 demo board manual for more information on the recommended layout that meets these requirements. While the LT3093 is robust and will not oscillate if the recommended layout is not followed, depending on the actual layout, phase/gain margin, noise and PSRR performance may degrade.

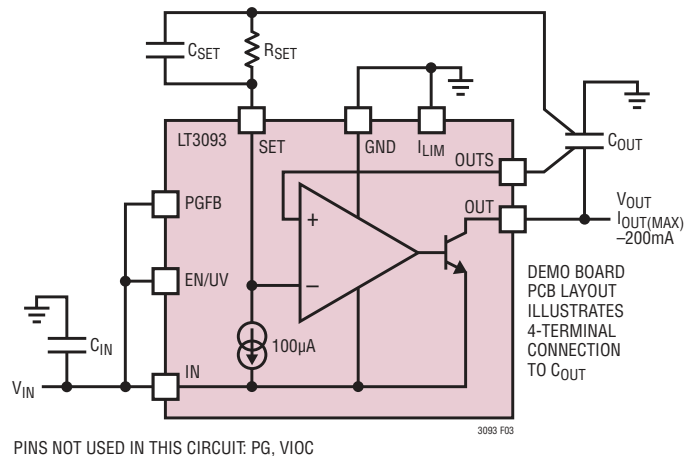

Figure 3. C_{OUT} and C_{SET} Connections for Best Performance

Stability and Output Capacitance

The LT3093 requires an output capacitor for stability. Given its high bandwidth, ADI recommends low ESR and ESL ceramic capacitors. A minimum 4.7 μ F output capacitance with an ESR below 30m Ω and an ESL below 1.5nH is required for stability.

Given the high PSRR and low noise performance attained with using a single 4.7 μ F ceramic output capacitor, larger values of output capacitor only marginally improve the performance because the regulator bandwidth decreases with increasing output capacitance—hence, there is little to be gained by using larger than the minimum 4.7 μ F output capacitor. Nonetheless, larger values of output capacitance do decrease peak output deviations during a load

APPLICATIONS INFORMATION

transient. Note that bypass capacitors used to decouple individual components powered by the LT3093 increase the effective output capacitance.

Give extra consideration to the type of ceramic capacitors used. They are manufactured with a variety of dielectrics, each with different behavior across temperature and applied voltage. The most common dielectrics used are specified with EIA temperature characteristic codes of Z5U, Y5V, X5R and X7R. The Z5U and Y5V dielectrics are good for providing high capacitance in small packages, but they tend to have stronger voltage and temperature coefficients as shown in Figure 4 and Figure 5. When used with a 5V regulator, a 16V 10 μ F Y5V capacitor can exhibit an effective value as low as 1 μ F to 2 μ F for the DC bias voltage applied over the operating temperature range.

The X5R and X7R dielectrics result in more stable characteristics and are thus more suitable for use with the LT3093. The X7R dielectric has better stability across temperature, while the X5R is less expensive and is available in higher values. Nonetheless, care must still be exercised when using X5R and X7R capacitors. The X5R and X7R codes only specify operating temperature range and the maximum capacitance change over temperature. While capacitance change due to DC bias for X5R and X7R is better than Y5V and Z5U dielectrics, it can still be significant enough to drop capacitance below sufficient levels. As shown in Figure 6, capacitor DC bias characteristics tend to improve as component case size increases, **but verification of expected capacitance at the operating voltage is highly recommended.**

High Vibration Environments

Voltage and temperature coefficients are not the only sources of problems. Some ceramic capacitors have a piezoelectric response. A piezoelectric device generates voltage across its terminals due to mechanical stress upon it, similar to how a piezoelectric microphone works. For a ceramic capacitor, this stress can be induced by mechanical vibrations within the system or due to thermal transients.

LT3093 applications in high vibration environments have three distinct piezoelectric noise generators: ceramic

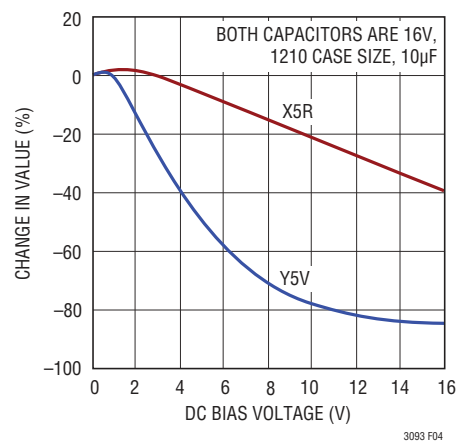

Figure 4. Ceramic Capacitor DC Bias Characteristics

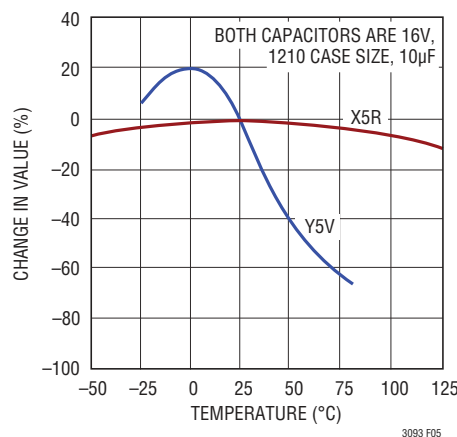

Figure 5. Ceramic Capacitor Temperature Characteristics

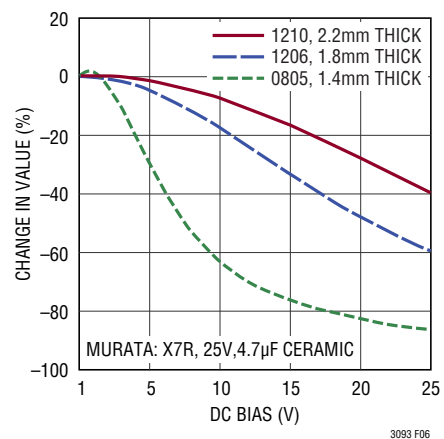

Figure 6. Capacitor Voltage Coefficient for Different Case Sizes

APPLICATIONS INFORMATION

output, input, and SET pin capacitors. However, due to the LT3093's very low output impedance over a wide frequency range, negligible output noise is generated using a ceramic output capacitor. Similarly, due to the LT3093's ultrahigh PSRR, negligible output noise is generated using a ceramic input capacitor. Given the high SET pin impedance, any piezoelectric response from a ceramic SET pin capacitor generates significant output noise; peak-to-peak excursions of hundreds of μV s are possible. However, due to the SET pin capacitor's high ESR and ESL tolerance, any non-piezoelectrically responsive (tantalum, electrolytic, or film) capacitor can be used at the SET pin; do note that electrolytic capacitors tend to have high $1/f$ noise. In any case, use of surface mount capacitors is highly recommended.

Stability and Input Capacitance

The LT3093 is stable with a minimum $4.7\mu\text{F}$ IN pin capacitor. ADI recommends using low ESR ceramic capacitors. Applications using long wires to connect the power supply to the LT3093's input and ground terminals together with low ESR ceramic input capacitors are prone to voltage spikes, reliability concerns and application-specific board oscillations. The wire inductance combined with the low ESR ceramic input capacitor forms a high Q resonant LC tank circuit. In some instances, this resonant frequency beats against the output current LDO bandwidth and interferes with stable operation. The resonant LC tank circuit formed by the wire inductance and input capacitor is the cause and not because of LT3093's instability.

The self inductance, or isolated inductance, of a wire is directly proportional to its length. The wire diameter, however, has less influence on its self inductance. For example, the self inductance of a 2-AWG isolated wire with a diameter of 0.26" is about half the inductance of a 30-AWG wire with a diameter of 0.01". One foot of 30-AWG wire has 465nH of self inductance.

Several methods exist to reduce a wire's self inductance. One method divides the current flowing towards the LT3093 between two parallel conductors. In this case, placing wire further apart reduces the inductance; up to a 50% reduction when placed only a few inches apart. Splitting the wires connects two equal inductors in parallel. However, when placed in close proximity to each other, their

mutual inductance adds to the overall self inductance of the wires—therefore a 50% reduction is not possible in such cases. The second and more effective technique to reduce the overall inductance is to place the forward and return current conductors (the input and ground wires) in close proximity. Two 30-AWG wires separated by 0.02" reduce the overall inductance to about one-fifth of a single wire.

If a battery mounted in close proximity powers the LT3093, a $4.7\mu\text{F}$ input capacitor suffices for stability. If a distantly located supply powers the LT3093, use a larger value input capacitor. Use a rough guideline of $1\mu\text{F}$ (in addition to the $4.7\mu\text{F}$ minimum) per 6" of wire length. The minimum input capacitance needed to stabilize the application also varies with the output capacitance as well as the load current. Placing additional capacitance on the LT3093's output helps. However, this requires significantly more capacitance compared to additional input bypassing. Series resistance between the supply and the LT3093 input also helps stabilize the application; as little as 0.1Ω to 0.5Ω suffices. This impedance dampens the LC tank circuit at the expense of dropout voltage. A better alternative is to use a higher ESR tantalum or electrolytic capacitor at the LT3093 input in parallel with a $4.7\mu\text{F}$ ceramic capacitor.

PSRR and Input Capacitance

For applications utilizing the LT3093 for post-regulating switching converters, placing a capacitor directly at the LT3093 input results in AC current (at the switching frequency) to flow near the LT3093. This relatively high frequency switching current generates magnetic fields that couple to the LT3093 output, degrading the effective PSRR. While highly dependent on the PCB layout, the switching preregulator, the size of the input capacitor and other factors, the PSRR degradation can easily be over 30dB at 1MHz. This degradation is present even with the LT3093 desoldered from the board, it is a degradation in the PSRR of the PCB itself. While negligible for conventional low PSRR LDOs, the LT3093's ultrahigh PSRR requires careful attention to higher order parasitics in order to realize the full performance offered by the regulator.

To mitigate the flow of high frequency switching current near the LT3093, the input capacitor can be entirely removed as long as the switching converter's output capacitor is located more than an inch away from

APPLICATIONS INFORMATION

the LT3093. Magnetic coupling decreases rapidly with increasing distance. If the switching regulator is placed too far away (conservatively more than a couple inches) from the LT3093, the lack of an input capacitor presents a high impedance at the input of the LT3093 and oscillation may occur. It is generally a common (and preferred) practice to bypass regulator inputs with some capacitance, so this option is fairly limited in its scope and not the most palatable solution.

To that end, ADI recommends referencing the LT3093 demo board layout for achieving the best possible PSRR performance. Two main factors contribute to higher PSRR with a poor layout. Parasitic trace inductance coupled with the low ESR ceramic input capacitor can lead to higher ripple at the input of the LDO than at the output of the driving supply. Also, physical loops create magnetic fields that couple from the input to the output. The LT3093 demo board utilizes layout techniques to minimize both parasitic inductance in traces and coupling of magnetic loops, preventing PSRR degradation while keeping the input capacitor.

Filtering High Frequency Spikes

For applications where the LT3093 is used to post-regulate a switching converter, its high PSRR effectively suppresses any harmonic content present at the switching frequency (typically 100kHz to 4MHz). However, there are very high frequency (hundreds of MHz) spikes associated with the switcher's power switch transition times that are beyond the LT3093's bandwidth and will almost directly pass through to the output. While the output capacitor is partly intended to absorb these spikes, its ESL will limit its ability at these frequencies. A ferrite bead or even the inductance associated with a short (e.g. 0.5") PCB trace coupled with a capacitor with a low impedance at the transition frequency can serve as an LC-filter to suppress these very high frequency spikes.

Output Noise

The LT3093 offers many advantages with respect to noise performance. Traditional linear regulators have several sources of noise. The most critical noise sources for a traditional regulator are its voltage reference, error amplifier, noise from the resistor divider network used for setting

output voltage and the noise gain created by this resistor divider. Many low noise regulators pin out their voltage reference to allow for noise reduction by bypassing the reference voltage.

Unlike most linear regulators, the LT3093 does not use a voltage reference; instead it uses a 100 μ A current reference. The current reference operates with typical noise current level of $27\text{pA}/\sqrt{\text{Hz}}$ (8nA_{RMS} over the 10Hz to 100kHz bandwidth). The resultant voltage noise equals the current noise multiplied by the resistor values, which is then RMS summed with the error amplifier's noise and the resistor's Johnson noise of $\sqrt{4kTR}$ (k = Boltzmann's constant, $1.38 \cdot 10^{-23}$ J/K, and T is absolute temperature) to give the net output noise.

One problem faced by conventional linear regulators is that the resistor divider setting the output voltage gains up the reference noise. In contrast, the LT3093's unity-gain follower architecture presents no gain from the SET pin to the output. Therefore, using a capacitor to bypass the SET pin resistor allows output voltage noise to be independent of the programmed output voltage. The resultant output noise is then determined only by the error amplifier's noise, typically $2\text{nV}/\sqrt{\text{Hz}}$ from 1kHz to 1MHz and $0.8\mu\text{V}_{\text{RMS}}$ in the 10Hz to 100kHz bandwidth when using a $4.7\mu\text{F}$ SET pin capacitor. Paralleling multiple LT3093s further reduces noise by \sqrt{N} for N parallel regulators.

Refer to the Typical Performance Characteristics section for noise spectral density and RMS integrated noise performance over various load currents and SET pin capacitances.

SET Pin (Bypass) Capacitance: Noise, PSRR, Transient Response and Soft-Start

In addition to reducing output noise, using a SET pin bypass capacitor also improves PSRR and transient performance. Note that any bypass capacitor leakage deteriorates the LT3093's DC regulation. Capacitor leakage of as little as 100nA causes a 0.1% DC error. ADI recommends the use of a good quality low leakage ceramic capacitor.

Using a SET pin bypass capacitor also soft starts the output and limits inrush current. The RC time constant formed by the SET pin resistor and capacitor determines

APPLICATIONS INFORMATION

soft-start time. Without the use of fast start-up, the ramp-up rate from 0 to 90% of nominal V_{OUT} is:

$$t_{SS} \approx 2.3 \cdot R_{SET} \cdot C_{SET} \text{ (Fast Start-Up Disabled)}$$

Fast Start-Up

For ultralow noise applications that require low 1/f noise (i.e. at frequencies below 100Hz) a larger value SET pin capacitor is required; up to 22 μ F may be used. While normally this would significantly increase the regulator's start-up time, the LT3093 incorporates fast start-up circuitry that increases the SET pin current to about 1.8mA during start-up.

As shown in the Block Diagram, the 1.8mA current source remains engaged while PGFB is less than -300 mV unless the regulator is in current limit, dropout, thermal shutdown, or input voltage is below the minimum V_{IN} .

If fast start-up capability is not used, tie PGFB to IN or to OUT (for output voltages more than -300 mV). Note that doing so also disables power good functionality.

ENABLE/UVLO

The EN/UV pin is used to put the regulator into a micro-power shutdown state. The LT3093 has an accurate -1.26 V turn-on threshold on the EN/UV pin with 215mV of hysteresis. This threshold can be used in conjunction with a resistor divider from the input supply to define an accurate undervoltage lockout (UVLO) threshold for the regulator. The EN/UV pin current (I_{EN}) at the threshold needs to be considered when calculating the resistor divider network. See the Electrical Characteristics table and Typical Performance curves for EN/UV pin characteristics. The EN/UV pin current can be ignored if R_{EN1} is less than 100k. Use the following formula to determine resistor divider values (See Programming Undervoltage Lockout in the Typical Application section):

$$V_{IN(UVLO)} = -1.26V \cdot (1 + R_{EN2} / R_{EN1}) - I_{EN} \cdot R_{EN2}$$

Since the EN/UV pin is bidirectional, it can also be pulled above 1.26V to turn on the LT3093. In bipolar supply applications, the positive EN/UV threshold can be used to sequence the turn-on of the LT3093 after the positive regulator has turned on. If unused, tie the EN/UV pin to IN.

High Efficiency Linear Regulator—Input-to-Output Voltage Control

The VIOC pin is used to control an upstream switching converter and facilitate a design solution that maximizes system efficiency while providing good transient response, low noise, and high power supply ripple rejection (PSRR) by maintaining a constant voltage across the LT3093 regardless of the device's output voltage. This works well in applications where the output voltage is varied for the application requirements. This regulation loop also minimizes total power dissipation in fault conditions; if the output is short-circuited and the LT3093 current limits, the VIOC amplifier lowers the switching regulator output voltage and limits the power dissipation in the LT3093.

The VIOC pin is the output of a fast unity-gain amplifier that measures the voltage differential between IN and OUTS or -1.5 V, whichever is lower. It typically connects to the feedback node or into the resistor divider of most LTC® switching regulators or LTM® power modules and sinks at least 100 μ A of current. Targeting -1 V differential from input-to-output provides an optimum tradeoff in terms of power dissipation and PSRR. The maximum output swing of the VIOC amplifier is limited only by the input voltage; it will provide an output all the way to maximum V_{IN} . If paralleling multiple LT3093's, tie the VIOC pin of one of the devices to the upstream switching converter's feedback pin and float the remaining VIOC pins.

The VIOC amplifier is designed to sink current, and only sources current through its internal impedance to ground. The VIOC pin has a typical impedance to ground of 120k $\pm 15\%$, this is important to consider if using a maximum input voltage configuration or if the LT3093 is disabled.

As the VIOC buffer operates with high bandwidth, the switching converter's frequency compensation doesn't need to be adjusted while the VIOC buffer is inside the switching converter's feedback loop. Phase delay through the VIOC buffer is typically less than 4° for frequencies as high as 100kHz; within the switching converter's bandwidth (usually well below 100kHz) the VIOC buffer is transparent and acts like an ideal wire. For example, with a switching converter with less than 100kHz bandwidth and a phase margin of 50°, using the VIOC buffer will

APPLICATIONS INFORMATION

degrade the phase margin by at most 4°. The net phase margin for the switching converter (using the VIOC pin) is at least 46°. With the VIOC buffer inside the switching converter's feedback loop, keep the total capacitance on the VIOC pin to below 20pF.

For $0 \geq V_{OUT} \geq -1.5V$, $V_{IN} = V_{VIOC(NOM)} - 1.5V$. For $V_{OUT} \leq -1.5V$, $V_{IN} = V_{OUT} + V_{VIOC(NOM)}$. The VIOC pin voltage (and the input-to-output differential) is programmable to anywhere between -0.33V (the dropout voltage of the regulator) and the input voltage. As shown in Figure 7, the input-to-output differential is easily programmed using the following equation:

$$V_{LDOIN} - V_{LDOOUT} = V_{VIOC(NOM)} = V_{FBSWITCHER} \cdot \frac{R1 + R2}{R1}$$

In the event that the SET pin has an open-circuit fault condition, the LT3093's input voltage will increase to the switching converter's maximum output voltage and may violate the LT3093's absolute maximum rating for V_{IN} . To prevent this, adding an optional resistor (R3) between the VIOC and IN pins of the regulator gives a maximum voltage configuration based on the following equation:

$$V_{LDOIN(MAX)} = V_{FBSWITCHER} \frac{R1 + R2 + R3}{R1} + V_{VIOC(NOM)} \frac{R3}{120k}$$

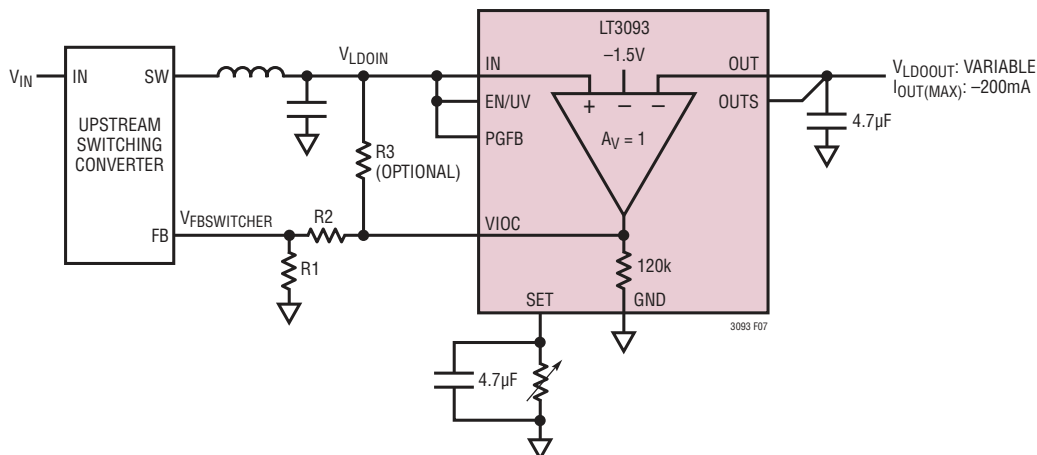

Figure 7. Typical VIOC Application

Typical VIOC Applications

Figure 8 shows an application using the LT8330 configured as an inverting regulator powering the LT3093 to deliver a -3.3V output. The resistors shown drive the FBX pin of the LT8330 to -0.8V so that its output is -4.3V (with -1V on the VIOC pin) when the LT3093 is operating at -3.3V output and is -5V when the LT3093 is disabled.

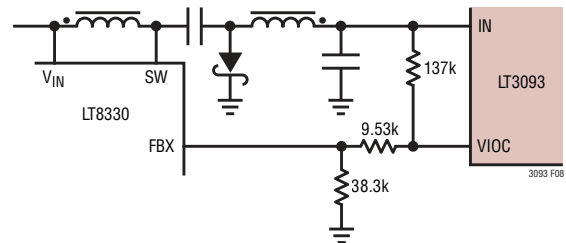

Figure 8. VIOC Connection Using LT8330 Delivers -4.3V When Operating, -5V When LT3093 is Disabled

Another inverting regulator configuration is shown in Figure 9, this time using the LT8580. The LT8580 FBX pin regulates at 3mV (typical) with 83.3µA flowing out

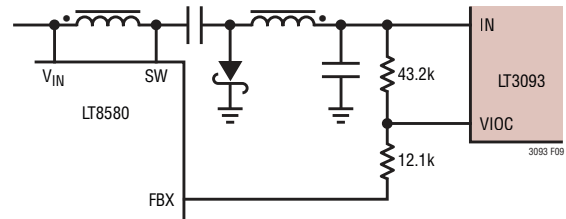

Figure 9. VIOC Connection Using LT8580

APPLICATIONS INFORMATION

of the pin (I_{FBX}). Because of this, only a single resistor is needed between the FBX pin and VIOC (from Figure 7, only R2 is necessary, R1 is not needed). In this case, the resistor is calculated as follows:

$$V_{LDOIN} - V_{LDOOUT} = V_{VIOC(NOM)} = V_{FBX} - R2 \cdot I_{FBX}$$

For the optional maximum voltage configuration, R3 is added and the maximum input voltage to the LT3093 is calculated as follows:

$$V_{LDOIN(MAX)} = V_{VIOC(NOM)} + V_{VIOC(NOM)} \frac{R3}{120k} - R3 \cdot I_{FBX}$$

Again, the resistors shown are configured to drive the output of the switcher to $-4.3V$ when the LT3093 is operating at $-3.3V$ output and $-5V$ when disabled. Using the circuit from Figure 9, the LDO's input and output is shown in Figure 10 when pulsing the LT3093's EN/UV pin. As can be seen, when the LDO is disabled, the LDO input voltage goes to the maximum voltage set by the resistor divider on the VIOC pin. Figure 11 shows the load step response of the LT8580 using the VIOC buffer. Figure 12 shows the LDO's input and output voltage response to stepping the SET pin voltage from $-3V$ to $-4V$. Figure 13 shows the LDO's input and output voltage while ramping the SET pin from $0V$ to $-4.5V$, and as can be seen, the LT8580's output voltage tracks the LT3093's output voltage when below $-1.5V$ and limits at the maximum voltage set by the resistor divider set on the VIOC pin. Last, Figure 14 shows the noise spectral density at the LT3093's input and output.

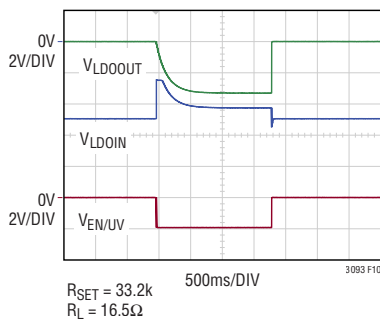

Figure 10. LT3093 EN/UV Pulse

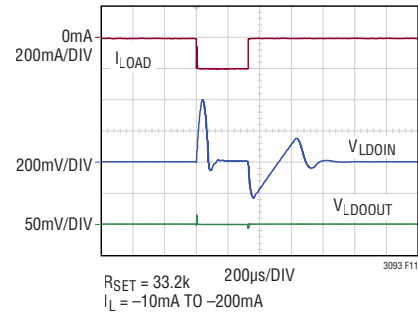

Figure 11. Load Step Response Using the VIOC Buffer

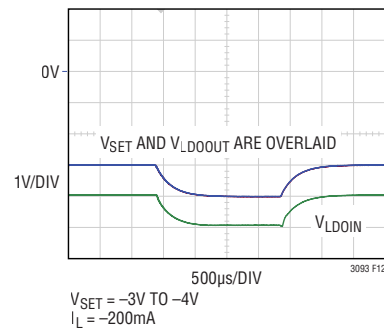

Figure 12. Stepping V_{SET} from $-3V$ to $-4V$ (and Back to $-3V$)

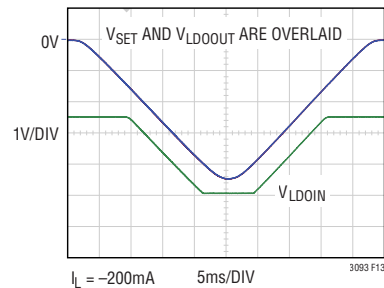

Figure 13. Ramping V_{SET} from $0V$ to $-4.5V$ (and Back to $0V$)

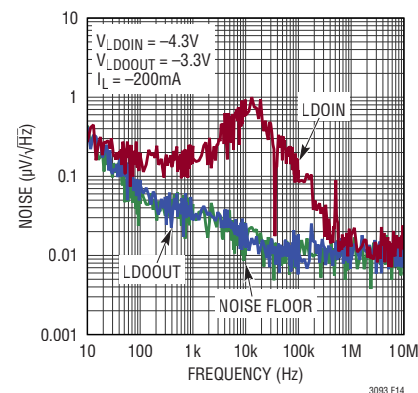

Figure 14. LT3093's Input and Output Noise Spectral Density

APPLICATIONS INFORMATION

Programmable Power Good

As illustrated in the Block Diagram, power good threshold is user programmable using the ratio of two external resistors, R_{PG1} and R_{PG2} :

$$V_{OUT(PG_THRESH)} = -0.3V(1 + R_{PG1}/R_{PG2}) - I_{PGFB} \cdot R_{PG1}$$

If the PGFB pin becomes less than $-300mV$, the open-collector PG pin deasserts and becomes high impedance. The power good comparator typically has $7mV$ hysteresis and $5\mu s$ of deglitching. The PGFB pin current (I_{PGFB}) can be ignored if R_{PG2} is less than $30k$, otherwise it must be considered when determining the resistor divider network. If power good functionality is not used, float the PG pin. Please note that programmable power good and fast start-up capabilities are disabled for output voltages between $0V$ and $-300mV$.

Take care when laying out traces for PG and PGFB on a PCB. If the PG and PGFB pins are run close to each other for a distance (typically greater than two inches), stray capacitance from trace-to-trace couples the PG signal into the high impedance PGFB signal. Since PG is out of phase relative to PGFB, this results in oscillation. To avoid this, minimize the distance the two traces run close to each other; lowering the impedance seen at the PGFB pin by using lower value resistors for the PGFB divider also helps.

Externally Programmable Current Limit

The I_{LIM} pin internally regulates to $-300mV$. Connecting a resistor from ground to I_{LIM} sets the current flowing into the I_{LIM} pin, which in turn programs the LT3093's current limit. With the $1.95k\Omega \cdot A$ programming scale factor, the current limit can be calculated as follows:

$$\text{Current Limit} = 1.95k\Omega \cdot A / R_{ILIM}$$

For example, a $9.76k$ resistor programs the current limit to $200mA$ and a $15k$ resistor programs the current limit to $130mA$. For good accuracy, Kelvin connect this resistor to the LT3093's GND pin.

In cases where the IN-to-OUT differential is greater than $7V$, the LT3093's foldback circuitry decreases the internal current limit. As a result, the internal current limit may override the externally programmed current limit to

keep the LT3093 within its safe-operating-area (SOA). See the graph of Internal Current Limit vs Input-to-Output Differential in the Typical Performance Characteristics section. If not used, tie I_{LIM} to GND.

Output Overshoot Recovery

During a load step from heavy load to very light or no load, the output voltage overshoots before the regulator responds to turn the power transistor off. With very light or no load, it takes a long time to discharge the output capacitor.

The LT3093 incorporates an overshoot recovery circuit that turns on a current source to discharge the capacitor in the event that OUTS is higher than SET. This current is typically $1.8mA$.

If OUTS is externally held above SET, the current source turns on in an attempt to restore OUTS to its programmed voltage. The current source remains on until the external circuitry releases OUTS.

Direct Paralleling for Higher Current

Higher output current is obtained by paralleling multiple LT3093s. Tie all SET pins together and all IN pins together. Connect the OUT pins together using small pieces of PCB trace (used as a ballast resistor) to equalize currents in the LT3093s. PCB trace resistance in $m\Omega/\text{inch}$ is shown in Table 2.

Table 2. PC Board Trace Resistance

WEIGHT (oz)	10mil WIDTH	20mil WIDTH
1	54.3	27.1
2	27.1	13.6

Trace resistance is measured in $m\Omega/\text{in}$.

The small worst-case offset of $2mV$ for each paralleled LT3093 minimizes the required ballast resistor value. Figure 15 illustrates that two LT3093s, each using a $50m\Omega$ PCB trace ballast resistor, provide better than 20% accurate output current sharing at full load. The two $50m\Omega$ external resistors only add $10mV$ of output regulation drop with a $1A$ maximum current. With a $-3.3V$ output, this only adds 0.3% to the regulation accuracy. As has been discussed previously, tie the OUTS pins directly to the output capacitors.

APPLICATIONS INFORMATION

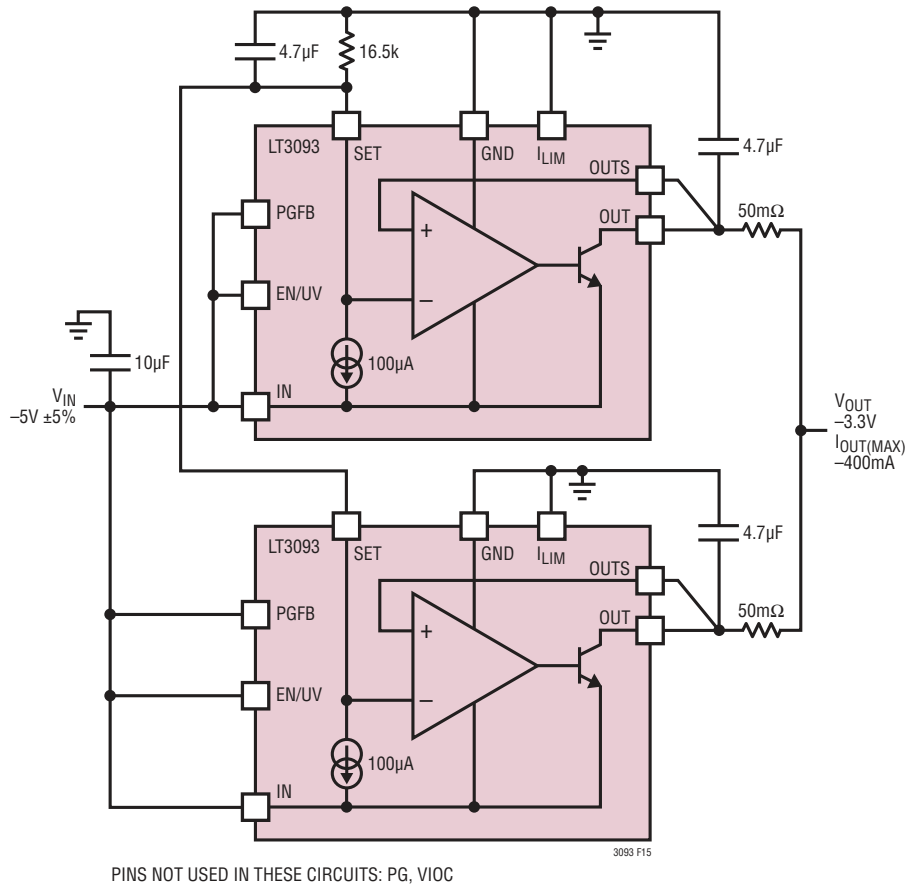

PINS NOT USED IN THESE CIRCUITS: PG, VIOC

Figure 15. Parallel Devices

More than two LT3093s can also be paralleled for even higher output current and lower output noise. Paralleling multiple LT3093s is also useful for distributing heat on the PCB. For applications with high input-to-output voltage differential, an input series resistor or a resistor in parallel with the LT3093 can also be used to spread heat.

PCB Layout Considerations

Given the LT3093's high bandwidth and ultrahigh PSRR, careful PCB layout must be employed to achieve full device performance. Figure 16 shows a recommended layout that delivers full performance of the regulator. Refer to the LT3093's DC2952A demo board manual for further details.

Thermal Considerations

The LT3093 has internal power and thermal limiting circuits that protect the device under overload conditions.

The thermal shutdown temperature is nominally 167°C with about 8°C of hysteresis. For continuous normal load conditions, do not exceed the maximum junction temperature (125°C for E- and I-grades, 150°C for H-grade). It is important to consider all sources of thermal resistance from junction to ambient. This includes junction-to-case, case-to-heat sink interface, heat sink resistance or circuit board-to-ambient as the application dictates. Additionally, consider all heat sources in close proximity to the LT3093.

The undersides of the DFN and MSOP packages have exposed metal from the lead frame to the die attachment. Both packages allow heat to directly transfer from the die junction to the PCB metal to limit maximum operating junction temperature. The dual-in-line pin arrangement allows metal to extend beyond the ends of the package on the topside (component side) of the PCB.

APPLICATIONS INFORMATION

For surface mount devices, heat sinking is accomplished by using the heat spreading capabilities of the PCB and its copper traces. Copper board stiffeners and plated through-holes can also be used to spread the heat generated by the regulator.

Table 3 and Table 4 list thermal resistance as a function of copper area on a fixed board size. All measurements were taken in still air on a 4-layer FR-4 board with 1oz solid internal planes and 2oz top/bottom planes with a total board thickness of 1.6mm. The four layers were electrically isolated with no thermal vias present. PCB layers, copper weight, board layout and thermal vias affect the resultant thermal resistance. For more

information on thermal resistance and high thermal conductivity test boards, refer to JEDEC standard JESD51, notably JESD51-7 and JESD51-12. Achieving low thermal resistance necessitates attention to detail and careful PCB layout.

Table 3. Measured Thermal Resistance for DFN Package

COPPER AREA		BOARD AREA	THERMAL RESISTANCE
TOP SIDE*	BOTTOM SIDE		
2500mm ²	2500mm ²	2500mm ²	34°C/W
1000mm ²	2500mm ²	2500mm ²	34°C/W
225mm ²	2500mm ²	2500mm ²	35°C/W
100mm ²	2500mm ²	2500mm ²	36°C/W

*Device is mounted on topside

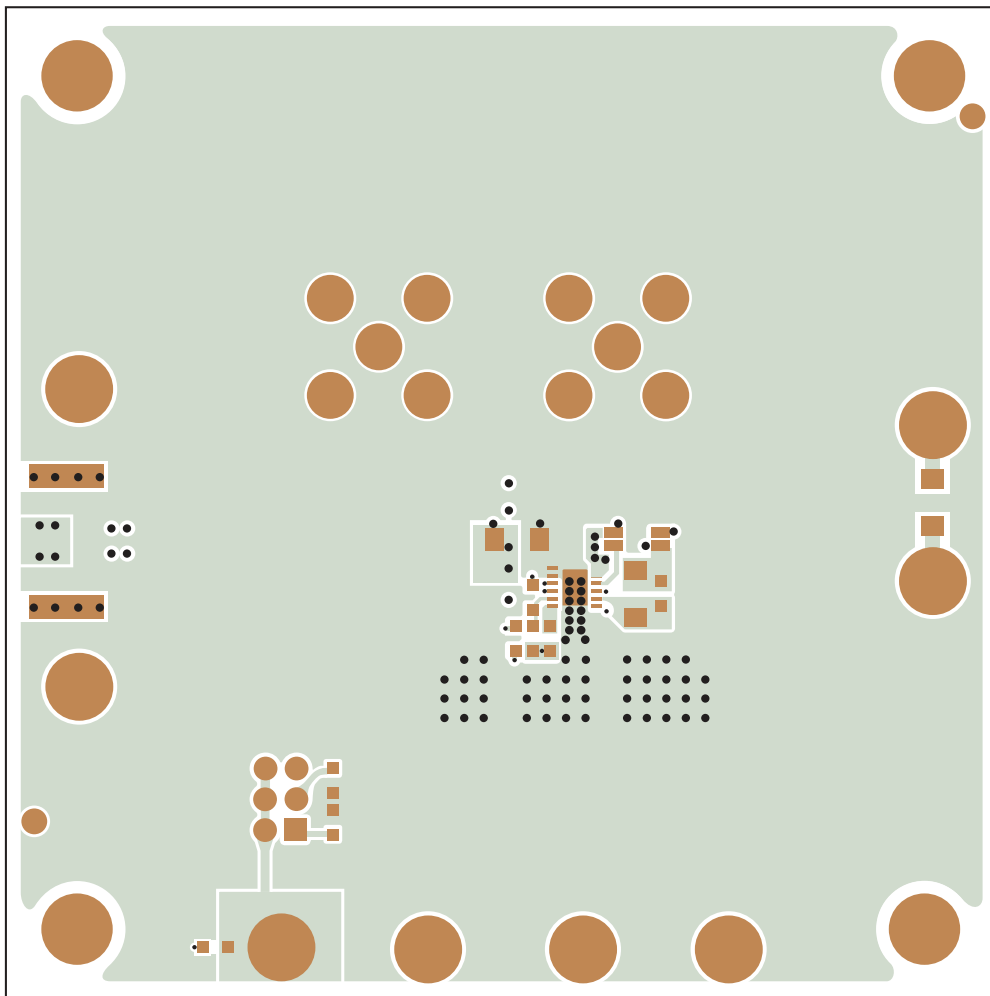

Figure 16. Recommended DFN Layout

APPLICATIONS INFORMATION

Table 4. Measured Thermal Resistance for MSOP Package

COPPER AREA		BOARD AREA	THERMAL RESISTANCE
TOP SIDE*	BOTTOM SIDE		
2500mm ²	2500mm ²	2500mm ²	33°C/W
1000mm ²	2500mm ²	2500mm ²	33°C/W
225mm ²	2500mm ²	2500mm ²	34°C/W
100mm ²	2500mm ²	2500mm ²	35°C/W

*Device is mounted on top side

Calculating Junction Temperature

Example: Given an output voltage of $-3.3V$ and input voltage of $-5V \pm 5\%$, output current range from $1mA$ to $200mA$, and a maximum ambient temperature of $85^{\circ}C$, what is the maximum junction temperature?

The LT3093's power dissipation is:

$$I_{OUT(MAX)} \cdot (V_{IN(MAX)} - V_{OUT}) + I_{GND} \cdot V_{IN(MAX)}$$

where:

$$I_{OUT(MAX)} = -200mA$$

$$V_{IN(MAX)} = -5.25V$$

$$I_{GND} \text{ (at } I_{OUT} = 200mA \text{ and } V_{IN} = -5.25V) = -5.8mA$$

thus:

$$P_{DISS} = -0.2A \cdot (-5.25V + 3.3V) + 5.8mA \cdot 5.25V = 0.42W$$

Using a DFN package, the thermal resistance is in the range of $34^{\circ}C/W$ to $36^{\circ}C/W$ depending on the copper area. Therefore, the junction temperature rise above ambient approximately equals:

$$0.42W \cdot 35^{\circ}C/W = 14.7^{\circ}C$$

The maximum junction temperature equals the maximum ambient temperature plus the maximum junction temperature rise above ambient:

$$T_{J(MAX)} = 85^{\circ}C + 14.7^{\circ}C = 99.7^{\circ}C$$

Overload Recovery

Like many IC power regulators, the LT3093 incorporates safe-operating-area (SOA) protection. The SOA protection activates at input-to-output differential voltages greater than $7V$. The SOA protection decreases the current limit

as the input-to-output differential increases and keeps the power transistor inside a safe operating region for all values of input-to-output voltages up to the LT3093's absolute maximum ratings. The LT3093 provides some level of output current for all values of input-to-output differential voltage. Refer to the Current Limit curves in the Typical Performance Characteristics section. When power is first applied and input voltage rises, the output follows the input and keeps the input-to-output differential low to allow the regulator to supply large output current and start-up into high current loads.

Due to current limit foldback, however, at high input voltages a problem can occur if the output voltage is low and the load current is high. Such situations occur after the removal of a short-circuit or if the EN/UV pin is pulled high after the input voltage has already turned on. The load line in such cases intersects the output current profile at two points. The regulator now has two stable operating points. With this double intersection, the input power supply may need to be cycled down to zero and brought back up again to make the output recover. Other linear regulators with foldback current limit protection (such as the LT3090, LT1964 and LT1175) also exhibit this phenomenon, so it is not unique to the LT3093.

Protection Features

The LT3093 incorporates several protection features for sensitive applications. Precision current limit and thermal overload protection safeguard the LT3093 against overload and fault conditions at the device's output. For normal operation, do not allow the junction temperature to exceed $125^{\circ}C$ (E- and I-grades) or $150^{\circ}C$ (H-grade).

Pulling the LT3093's output above ground induces no damage to the part. If IN is left open circuit or grounded, OUT can be pulled $20V$ above GND. In this condition, a maximum current of $25mA$ flows into the OUT pin and out of the GND pin. If IN is powered by a voltage source, OUT sinks the LT3093's (foldback) short circuit current and protects itself by thermal limiting. In this case, however, grounding the EN/UV pin turns off the device and stops OUT from sinking the short-circuit current.

TYPICAL APPLICATION

Programming Undervoltage Lookout

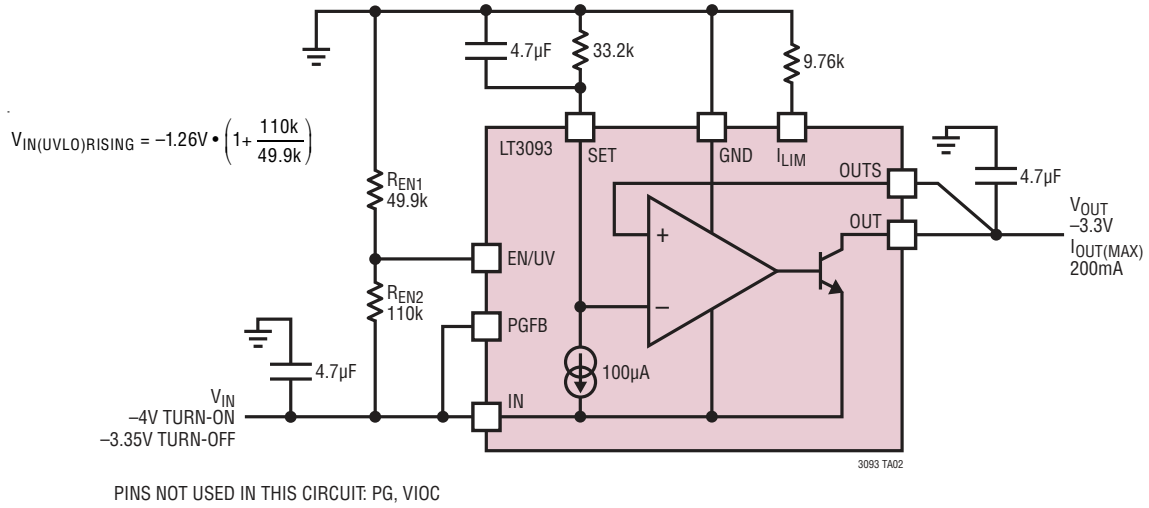

PACKAGE DESCRIPTION

DD Package
12-Lead Plastic DFN (3mm × 3mm)
 (Reference LTC DWG # 05-08-1725 Rev A)

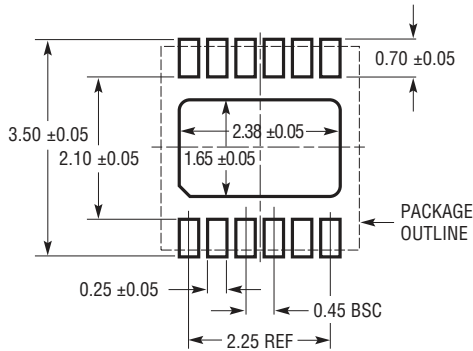

RECOMMENDED SOLDER PAD PITCH AND DIMENSIONS
 APPLY SOLDER MASK TO AREAS THAT ARE NOT SOLDERED

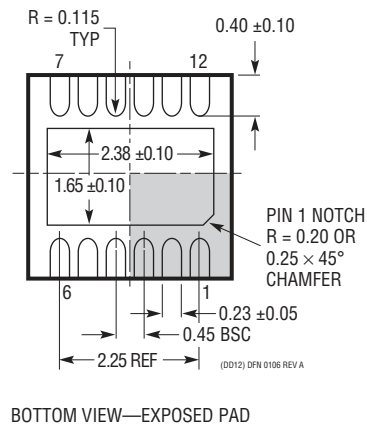
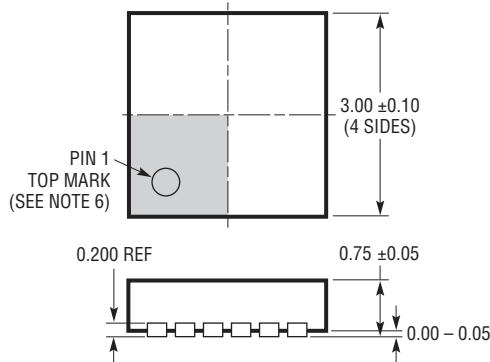

- NOTE:
1. DRAWING IS NOT A JEDEC PACKAGE OUTLINE
 2. DRAWING NOT TO SCALE
 3. ALL DIMENSIONS ARE IN MILLIMETERS
 4. DIMENSIONS OF EXPOSED PAD ON BOTTOM OF PACKAGE DO NOT INCLUDE MOLD FLASH. MOLD FLASH, IF PRESENT, SHALL NOT EXCEED 0.15mm ON ANY SIDE
 5. EXPOSED PAD AND TIE BARS SHALL BE SOLDER PLATED
 6. SHADED AREA IS ONLY A REFERENCE FOR PIN 1 LOCATION ON THE TOP AND BOTTOM OF PACKAGE

PACKAGE DESCRIPTION

MSE Package
12-Lead Plastic MSOP, Exposed Die Pad
 (Reference LTC DWG # 05-08-1666 Rev G)

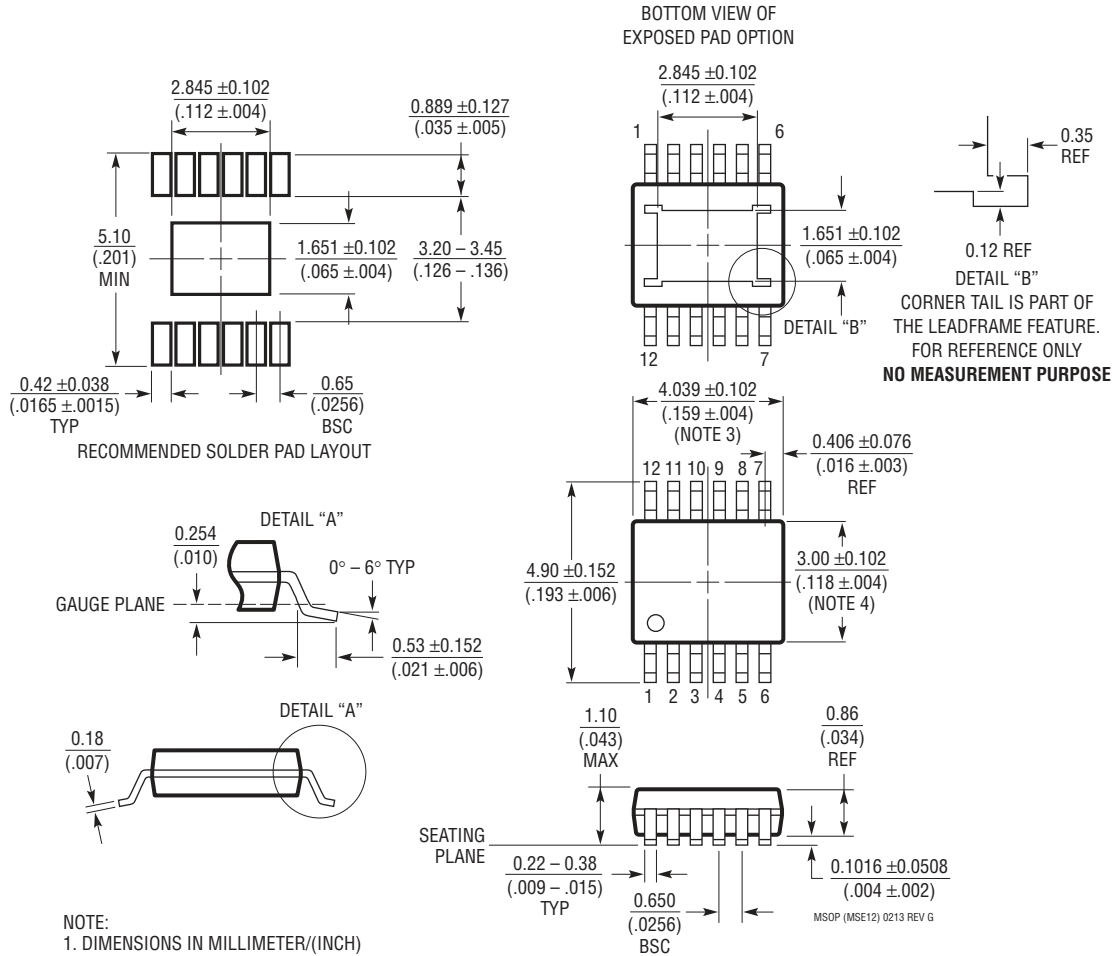

- NOTE:
1. DIMENSIONS IN MILLIMETER/(INCH)
 2. DRAWING NOT TO SCALE
 3. DIMENSION DOES NOT INCLUDE MOLD FLASH, PROTRUSIONS OR GATE BURRS.
MOLD FLASH, PROTRUSIONS OR GATE BURRS SHALL NOT EXCEED 0.152mm (.006") PER SIDE
 4. DIMENSION DOES NOT INCLUDE INTERLEAD FLASH OR PROTRUSIONS.
INTERLEAD FLASH OR PROTRUSIONS SHALL NOT EXCEED 0.152mm (.006") PER SIDE
 5. LEAD COPLANARITY (BOTTOM OF LEADS AFTER FORMING) SHALL BE 0.102mm (.004") MAX
 6. EXPOSED PAD DIMENSION DOES INCLUDE MOLD FLASH. MOLD FLASH ON E-PAD SHALL NOT EXCEED 0.254mm (.010") PER SIDE.

TYPICAL APPLICATION

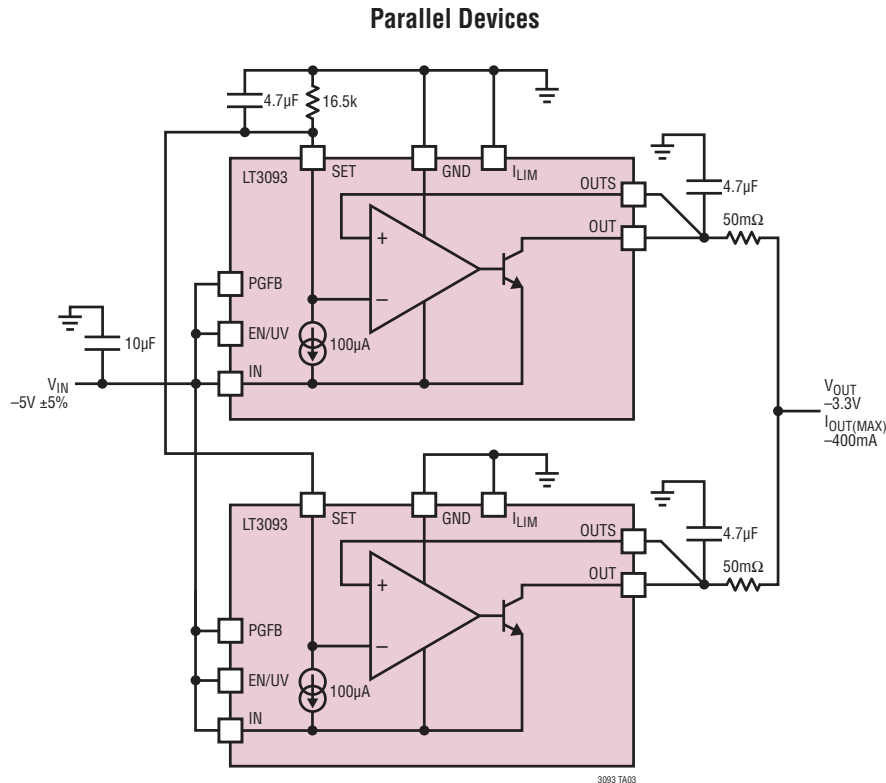

PINS NOT USED IN THIS CIRCUIT: PG, VI OC

RELATED PARTS

PART NUMBER	DESCRIPTION	COMMENTS
LT3094	-20V, 500mA, Ultralow Noise Ultrahigh PSRR Negative Linear Regulator	0.8µV _{RMS} Noise and 74dB PSRR at 1MHz, V _{IN} = -1.8V to -20V, 235mV Dropout Voltage, Programmable Current Limit and Power Good, 3mm × 3mm DFN and MSOP Packages
LT3045	20V, 500mA, Ultralow Noise Ultrahigh PSRR Linear Regulator	0.8µV _{RMS} Noise and 75dB PSRR at 1MHz, V _{IN} = 1.8V to 20V, 260mV Dropout Voltage, 3mm × 3mm DFN and MSOP Packages
LT3042	20V, 200mA, Ultralow Noise Ultrahigh PSRR Linear Regulator	0.8µV _{RMS} Noise and 79dB PSRR at 1MHz, V _{IN} = 1.8V to 20V, 350mV Dropout Voltage, Programmable Current Limit and Power Good, 3mm × 3mm DFN and MSOP Packages
LT3090	-36V, 600mA Negative Linear Regulator with Programmable Current Limit	300mV Dropout Voltage, Low Noise: 18µV _{RMS} , V _{IN} : -1.5V to -36V, Single Resistor Output, DFN and MSOP Packages
LT3091	-36V, 1.5A Negative Linear Regulator	300mV Dropout Voltage, Low Noise: 18µV _{RMS} , V _{IN} : -1.5V to -36V, Single Resistor Output, DFN, TSSOP, TO-220 and DD-Pak Packages
LT1175	500mA, Negative Low Dropout Micropower Regulator	500mV Dropout Voltage, V _{IN} = -4.5V to -20V, N8, S8, DD-PAK, TO-220 and SOT-223 Packages
LT1964	200mA, Negative Low Noise Low Dropout Regulator	340mV Dropout Voltage, Low Noise: 30µV _{RMS} , V _{IN} = -1.9V to -20V, DFN and SOT-23 Packages
LT3015	1.5A, Fast Transient Response, Negative LDO Regulator	310mV Dropout Voltage, Low Noise: 60µV _{RMS} , V _{IN} = -2.3V to -30V, DFN, MSOP, TO-220 and DD-PAK Packages
LT3080	1.1A, Parallelable, Low Noise, Low Dropout Linear Regulator	350mV Dropout Voltage (2-Supply Operation), Low Noise: 40µV _{RMS} , V _{IN} : 1.2V to 36V, Single Resistor Output, DFN, MSOP, TO-220, DD and SOT-223 Packages
LT3085	500mA, Parallelable, Low Noise, Low Dropout Linear Regulator	275mV Dropout Voltage (2-Supply Operation), Low Noise: 40µV _{RMS} , V _{IN} : 1.2V to 36V, Single Resistor Output, DFN and MSOP Packages