

# LOW INPUT CURRENT PHOTOTRANSISTOR OPTOCOUPLERS

**MCT5200**

**MCT5201**

**MCT5210**

**MCT5211**

## Description

The MCT52XX series consists of a high-efficiency AlGaAs, infrared emitting diode, coupled with an NPN phototransistor in a six pin dual-in-line package.

The MCT52XX is well suited for CMOS to LSTT/TTL interfaces, offering 250%  $CTR_{CE(SAT)}$  with 1 mA of LED input current. When an LED input current of 1.6 mA is supplied data rates to 20K bits/s are possible.

The MCT52XX can easily interface LSTTL to LSTTL/TTL, and with use of an external base to emitter resistor data rates of 100K bits/s can be achieved.

## Features

- High  $CTR_{CE(SAT)}$  comparable to Darlington
- CTR guaranteed 0°C to 70°C
- High common mode transient rejection 5kV/μs
- Data rates up to 150 kbits/s (NRZ)
- Underwriters Laboratory (UL) recognized (file #E90700)
- VDE recognized (file #94766)
  - Add option 300 (e.g., MCT5211.300)

## Applications

- CMOS to CMOS/LSTTL logic isolation
- LSTTL to CMOS/LSTTL logic isolation
- RS-232 line receiver
- Telephone ring detector
- AC line voltage sensing
- Switching power supply

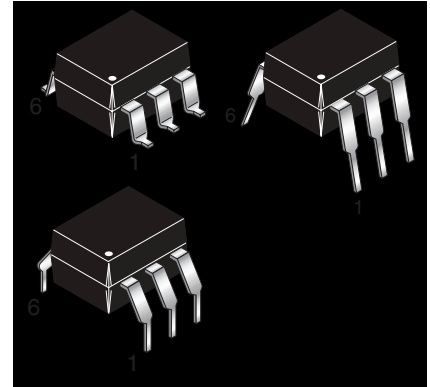

## SCHEMATIC

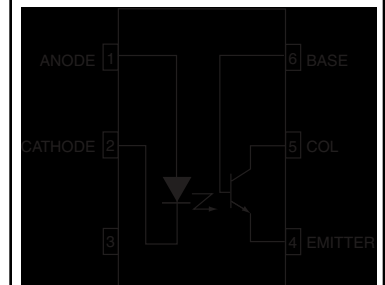

Parameters	Symbol	Device	Value	Units
<b>TOTAL DEVICE</b>				
Storage Temperature	$T_{STG}$	All	-55 to +150	°C
Operating Temperature	$T_{OPR}$	All	-55 to +100	°C
Lead Solder Temperature	$T_{SOL}$	All	260 for 10 sec	°C
Total Device Power Dissipation @ 25°C (LED plus detector)	$P_D$	All	260	mW
Derate Linearly From 25°C			3.5	mW/°C
<b>EMITTER</b>				
Continuous Forward Current	$I_F$	All	50	mA
Reverse Input Voltage	$V_R$	All	6	V
Forward Current - Peak (1 μs pulse, 300 pps)	$I_F(pk)$	All	3.0	A
LED Power Dissipation	$P_D$	All	75	mW
Derate Linearly From 25°C		All	1.0	mW/°C
<b>DETECTOR</b>				
Continuous Collector Current	$I_C$	All	150	mA
Detector Power Dissipation	$P_D$	All	150	mW
Derate Linearly from 25°C		All	2.0	mW/°C

# LOW INPUT CURRENT PHOTOTRANSISTOR OPTOCOUPLEDERS

**MCT5200**
**MCT5201**
**MCT5210**
**MCT5211**
**ELECTRICAL CHARACTERISTICS** ( $T_A = 25^\circ\text{C}$  Unless otherwise specified.)

**INDIVIDUAL COMPONENT CHARACTERISTICS**

Parameters	Test Conditions	Symbol	Device	Min	Typ**	Max	Units
<b>EMITTER</b>							
Input Forward Voltage	( $I_F = 5\text{ mA}$ )	$V_F$	All		1.25	1.5	V
Forward Voltage Temp. Coefficient	( $I_F = 2\text{ mA}$ )	$\frac{\Delta V_F}{\Delta T_A}$	All		-1.75		mV/ $^\circ\text{C}$
Reverse Voltage	( $I_R = 10\ \mu\text{A}$ )	$V_R$	All	6			V
Junction Capacitance	( $V_F = 0\text{ V}$ , $f = 1.0\text{ MHz}$ )	$C_J$	All		18		pF
<b>DETECTOR</b>							
Collector-Emitter Breakdown Voltage	( $I_C = 1.0\text{ mA}$ , $I_F = 0$ )	$BV_{CEO}$	All	30	100		V
Collector-Base Breakdown Voltage	( $I_C = 10\ \mu\text{A}$ , $I_F = 0$ )	$BV_{CBO}$	All	30	120		V
Emitter-Base Breakdown Voltage	( $I_C = 10\ \mu\text{A}$ , $I_F = 0$ )	$BV_{EBO}$	All	5	10		V
Collector-Emitter Dark Current	( $V_{CE} = 10\text{V}$ , $I_F = 0$ , $R_{BE} = 1\text{M}\Omega$ )	$I_{CER}$	All		1	100	nA
Capacitance	Collector to Emitter	( $V_{CE} = 0$ , $f = 1\text{ MHz}$ )	$C_{CE}$	All		10	pF
	Collector to Base	( $V_{CB} = 0$ , $f = 1\text{ MHz}$ )	$C_{CB}$	All		80	pF
	Emitter to Base	( $V_{EB} = 0$ , $f = 1\text{ MHz}$ )	$C_{EB}$	All		15	pF

**ISOLATION CHARACTERISTICS**

Characteristic	Test Conditions	Symbol	Device	Min	Typ**	Max	Units
Input-Output Isolation Voltage <sup>(10)</sup>	( $f = 60\text{Hz}$ , $t = 1\text{ min.}$ )	$V_{ISO}$	All	5300			Vac(rms)
Isolation Resistance <sup>(10)</sup>	$V_{I-O} = 500\text{ VDC}$ , $T_A = 25^\circ\text{C}$	$R_{ISO}$	All	$10^{11}$			$\Omega$
Isolation Capacitance <sup>(9)</sup>	$V_{I-O} = 0$ , $f = 1\text{ MHz}$	$C_{ISO}$	All		0.7		pF
Common Mode Transient Rejection – Output High	$V_{CM} = 50\text{ V}_{P-P1}$ , $R_L = 750\Omega$ , $I_F = 0$	$CM_H$	MCT5210/11		5000		V/ $\mu\text{s}$
	$V_{CM} = 50\text{ V}_{P-P}$ , $R_L = 1\text{K}\Omega$ , $I_F = 0$		MCT5200/01				
Common Mode Transient Rejection – Output Low	$V_{CM} = 50\text{ V}_{P-P1}$ , $R_L = 750\Omega$ , $I_F = 1.6\text{mA}$	$CM_L$	MCT5210/11		5000		V/ $\mu\text{s}$
	$V_{CM} = 50\text{ V}_{P-P1}$ , $R_L = 1\text{K}\Omega$ , $I_F = 5\text{ mA}$		MCT5200/01				

 \*\*All typical  $T_A=25^\circ\text{C}$

# LOW INPUT CURRENT PHOTOTRANSISTOR OPTOCOUPLEDERS

**MCT5200**
**MCT5201**
**MCT5210**
**MCT5211**
**TRANSFER CHARACTERISTICS** ( $T_A = 0^\circ\text{C}$  to  $70^\circ\text{C}$  Unless otherwise specified.)

DC Characteristics	Test Conditions	Symbol	Device	Min	Typ**	Max	Units
Saturated Current Transfer Ratio <sup>(1)</sup> (Collector to Emitter)	$I_F = 10\text{ mA}, V_{CE} = 0.4\text{ V}$	$CTR_{CE(SAT)}$	MCT5200	75			%
	$I_F = 5\text{ mA}, V_{CE} = 0.4\text{ V}$		MCT5201	120			
	$I_F = 3.0\text{ mA}, V_{CE} = 0.4\text{ V}$		MCT5210	60			
	$I_F = 1.6\text{ mA}, V_{CE} = 0.4\text{ V}$		MCT5211	100			
	$I_F = 1.0\text{ mA}, V_{CE} = 0.4\text{ V}$			75			
Current Transfer Ratio (Collector to Emitter) <sup>(1)</sup>	$I_F = 3.0\text{ mA}, V_{CE} = 5.0\text{ V}$	$CTR_{(CE)}$	MCT5210	70			%
	$I_F = 1.6\text{ mA}, V_{CE} = 5.0\text{ V}$		MCT5211	150			
	$I_F = 1.0\text{ mA}, V_{CE} = 5.0\text{ V}$			110			
Current Transfer Ratio Collector to Base <sup>(2)</sup>	$I_F = 10\text{ mA}, V_{CB} = 4.3\text{ V}$	$CTR_{(CB)}$	MCT5200	0.2			%
	$I_F = 5\text{ mA}, V_{CB} = 4.3\text{ V}$		MCT5201	0.28			
	$I_F = 3.0\text{ mA}, V_{CE} = 4.3\text{ V}$		MCT5210	0.2			
	$I_F = 1.6\text{ mA}, V_{CE} = 4.3\text{ V}$		MCT5211	0.3			
	$I_F = 1.0\text{ mA}, V_{CE} = 4.3\text{ V}$			0.25			
Saturation Voltage	$I_F = 10\text{ mA}, I_{CE} = 7.5\text{ mA}$	$V_{CE(SAT)}$	MCT5200			0.4	V
	$I_F = 5\text{ mA}, I_{CE} = 6\text{ mA}$		MCT5201			0.4	
	$I_F = 3.0\text{ mA}, I_{CE} = 1.8\text{ mA}$		MCT5210			0.4	
	$I_F = 1.6\text{ mA}, I_{CE} = 1.6\text{ mA}$		MCT5211			0.4	
AC Characteristics	Test Conditions	Symbol	Device	Min	Typ	Max	Units
Propagation Delay High to Low <sup>(3)</sup>	$R_L = 330\ \Omega, R_{BE} = \infty$	$T_{PHL}$	MCT5210		10		$\mu\text{s}$
	$R_L = 3.3\text{ k}\Omega, R_{BE} = 39\text{ k}\Omega$				7		
	$R_L = 750\ \Omega, R_{BE} = \infty$		MCT5211		14		
	$R_L = 4.7\text{ k}\Omega, R_{BE} = 91\text{ k}\Omega$				15		
	$R_L = 1.5\text{ k}\Omega, R_{BE} = \infty$		MCT5210		17		
	$R_L = 10\text{ k}\Omega, R_{BE} = 160\text{ k}\Omega$				24		
	$V_{CE} = 0.4\text{ V}, V_{CC} = 5\text{ V},$ $R_L = \text{fig. 13}, R_{BE} = 330\text{ k}\Omega$		MCT5200		1.6	12	
			MCT5201		3	30	
Propagation Delay Low to High <sup>(4)</sup>	$R_L = 330\ \Omega, R_{BE} = \infty$	$T_{PLH}$	MCT5210		0.4		$\mu\text{s}$
	$R_L = 3.3\text{ k}\Omega, R_{BE} = 39\text{ k}\Omega$				8		
	$R_L = 750\ \Omega, R_{BE} = \infty$		MCT5211		2.5		
	$R_L = 4.7\text{ k}\Omega, R_{BE} = 91\text{ k}\Omega$				11		
	$R_L = 1.5\text{ k}\Omega, R_{BE} = \infty$		MCT5200		7		
	$R_L = 10\text{ k}\Omega, R_{BE} = 160\text{ k}\Omega$				16		
	$V_{CE} = 0.4\text{ V}, V_{CC} = 5\text{ V},$ $R_L = \text{fig. 13}, R_{BE} = 330\text{ k}\Omega$		MCT5200		18	20	
			MCT5201		12	13	
Delay Time <sup>(5)</sup>	$V_{CE} = 0.4\text{ V},$ $R_{BE} = 330\text{ k}\Omega,$ $R_L = 1\text{ k}\Omega, V_{CC} = 5\text{ V}$	$t_d$	MCT5200		0.5	7	$\mu\text{s}$
			MCT5201		1.1	15	
Rise Time <sup>(6)</sup>	$V_{CE} = 0.4\text{ V},$ $R_{BE} = 330\text{ k}\Omega,$ $R_L = 1\text{ k}\Omega, V_{CC} = 5\text{ V}$	$t_r$	MCT5200		1.3	6	$\mu\text{s}$
			MCT5201		2.5	20	

# LOW INPUT CURRENT PHOTOTRANSISTOR OPTOCOUPERS

**MCT5200**

**MCT5201**

**MCT5210**

**MCT5211**

**TRANSFER CHARACTERISTICS** ( $T_A = 0^\circ\text{C}$  to  $70^\circ\text{C}$  Unless otherwise specified.) (Continued)

DC Characteristics	Test Conditions		Symbol	Device	Min	Typ**	Max	Units
Storage Time <sup>(7)</sup>	$V_{CE} = 0.4\text{V}$ , $R_{BE} = 330\text{ k}\Omega$ , $R_L = 1\text{ k}\Omega$ , $V_{CC} = 5\text{V}$	$I_F = 10\text{mA}$	$t_s$	MCT5200		15	18	$\mu\text{s}$
		$I_F = 5\text{mA}$		MCT5201		10	13	
Fall Time <sup>(8)</sup>	$V_{CE} = 0.4\text{V}$ , $R_{BE} = 330\text{ k}\Omega$ , $R_L = 1\text{ k}\Omega$ , $V_{CC} = 5\text{V}$	$I_F = 10\text{mA}$	$t_f$	MCT5200		16	30	$\mu\text{s}$
		$I_F = 5\text{mA}$		MCT5201		16	30	

\*\*All typicals at  $T_A = 25^\circ\text{C}$

Notes

- DC Current Transfer Ratio ( $CTR_{CE}$ ) is defined as the transistor collector current ( $I_{CE}$ ) divided by the input LED current ( $I_F$ ) x 100%, at a specified voltage between the collector and emitter ( $V_{CE}$ ).
- The collector base Current Transfer Ratio ( $CTR_{CB}$ ) is defined as the transistor collector base photocurrent ( $I_{CB}$ ) divided by the input LED current ( $I_F$ ) time 100%.
- Referring to Figure 14 the  $T_{PHL}$  propagation delay is measured from the 50% point of the rising edge of the data input pulse to the 1.3V point on the falling edge of the output pulse.
- Referring to Figure 14 the  $T_{PLH}$  propagation delay is measured from the 50% point of the falling edge of data input pulse to the 1.3V point on the rising edge of the output pulse.
- Delay time ( $t_d$ ) is measured from 50% of rising edge of LED current to 90% of  $V_o$  falling edge.
- Rise time ( $t_r$ ) is measured from 90% to 10% of  $V_o$  falling edge.
- Storage time ( $t_s$ ) is measured from 50% of falling edge of LED current to 10% of  $V_o$  rising edge.
- Fall time ( $t_f$ ) is measured from 10% to 90% of  $V_o$  rising edge.
- $C_{ISO}$  is the capacitance between the input (pins 1, 2, 3 connected) and the output, (pin 4, 5, 6 connected).
- Device considered a two terminal device: Pins 1, 2, and 3 shorted together, and pins 5, 6 and 7 are shorted together.

# LOW INPUT CURRENT PHOTOTRANSISTOR OPTOCOUPLERS

MCT5200

MCT5201

MCT5210

MCT5211

## TYPICAL PERFORMANCE GRAPHS

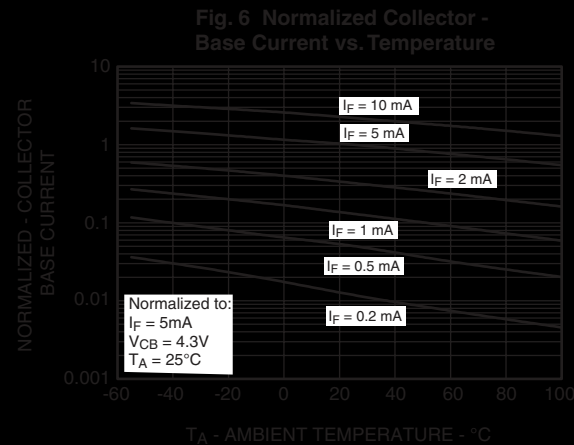
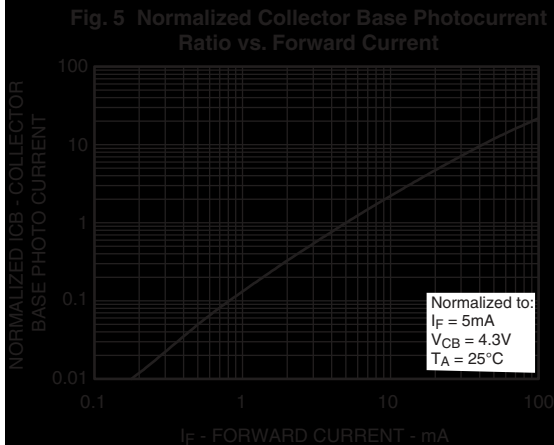
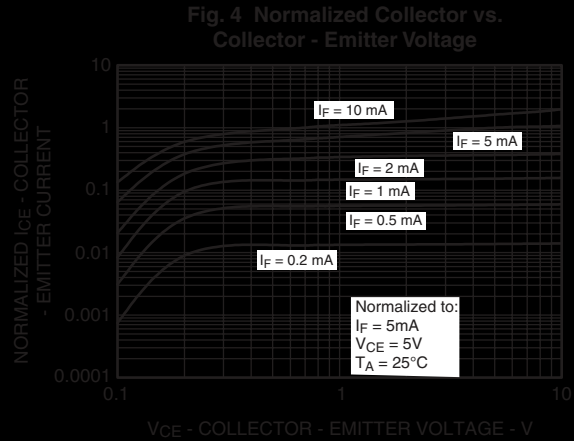
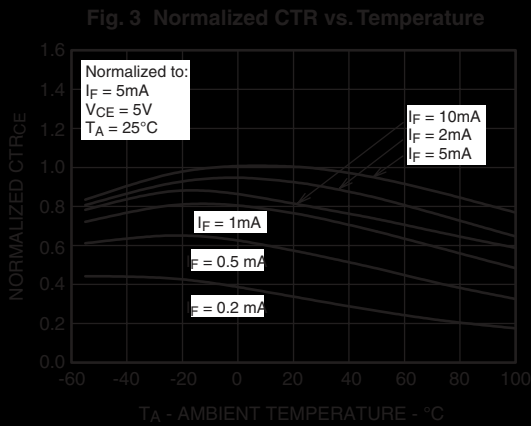
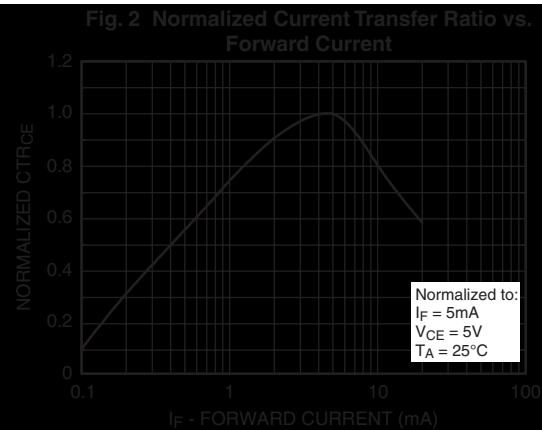
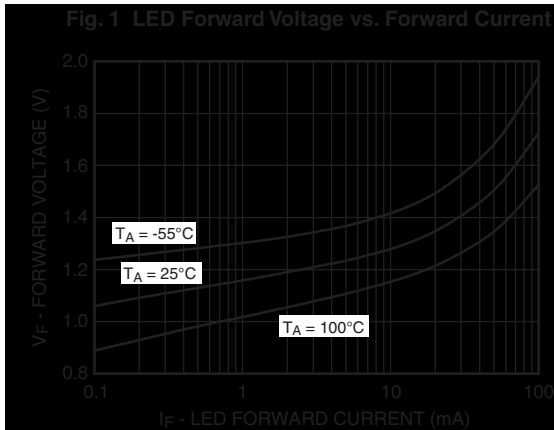

# LOW INPUT CURRENT PHOTOTRANSISTOR OPTOCOUPLEDERS

MCT5200

MCT5201

MCT5210

MCT5211

## TYPICAL PERFORMANCE GRAPHS (Continued)

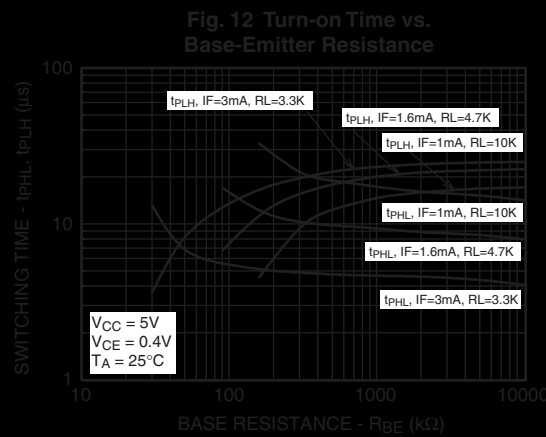
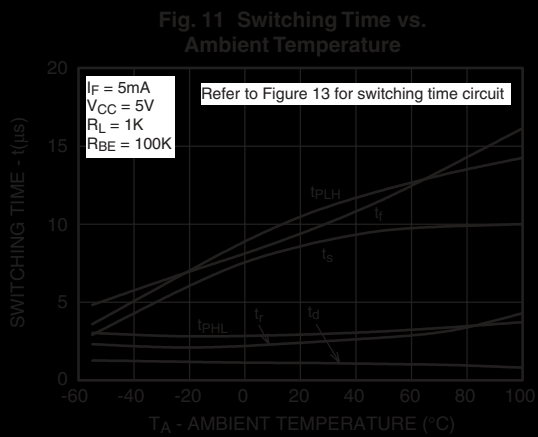
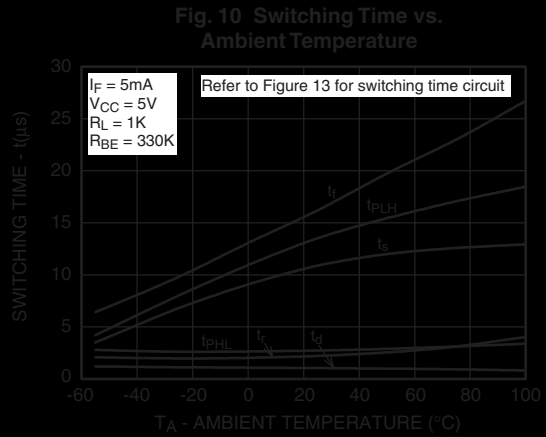
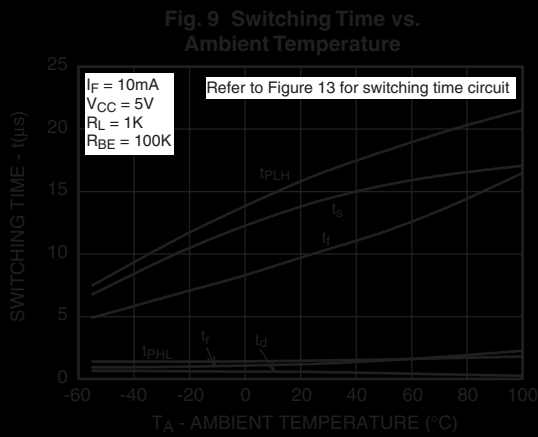
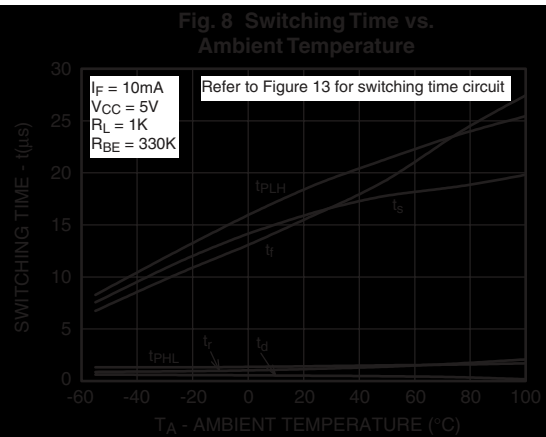
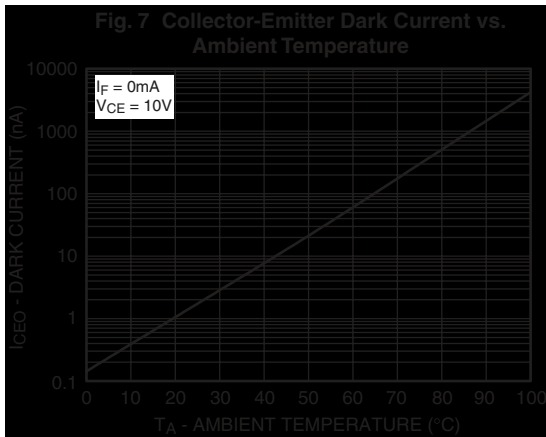

# LOW INPUT CURRENT PHOTOTRANSISTOR OPTOCOUPLERS

MCT5200

MCT5201

MCT5210

MCT5211

TYPICAL ELECTRO-OPTICAL CHARACTERISTICS (TA = 25°C Unless Otherwise Specified)

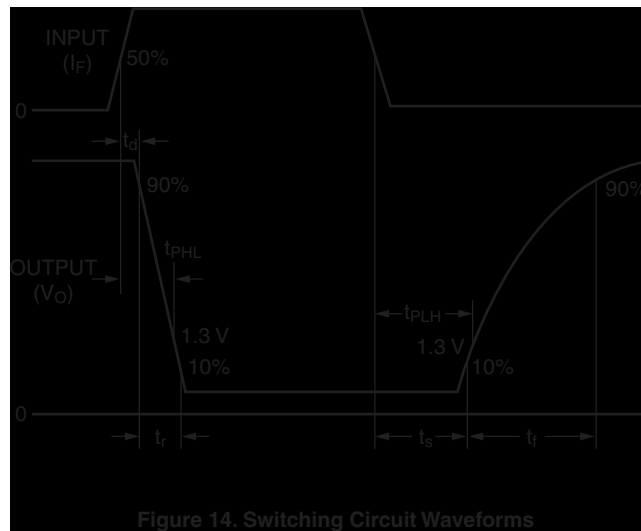
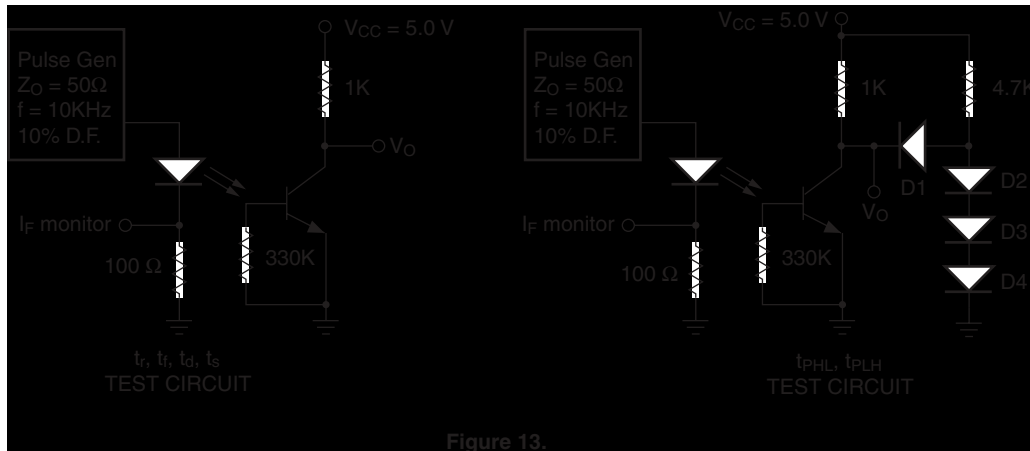

# LOW INPUT CURRENT PHOTOTRANSISTOR OPTOCOUPPLERS

MCT5200

MCT5201

MCT5210

MCT5211

**Package Dimensions (Through Hole)**

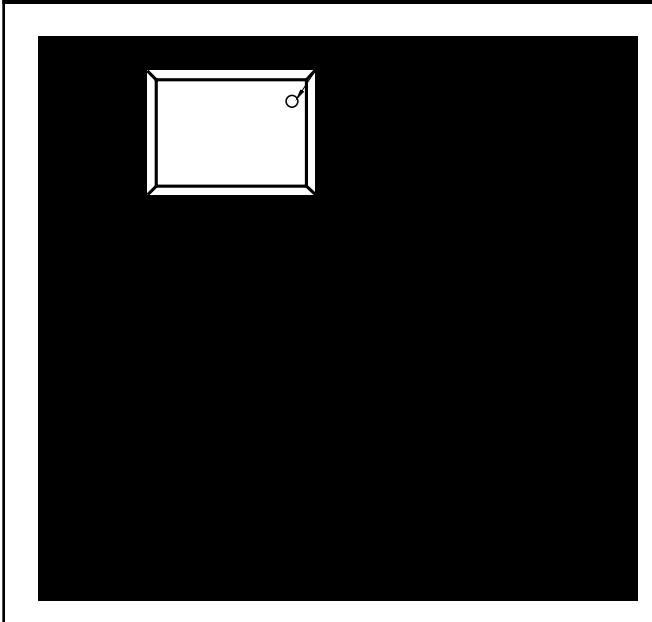

**Package Dimensions (Surface Mount)**



**Package Dimensions (0.4" Lead Spacing)**

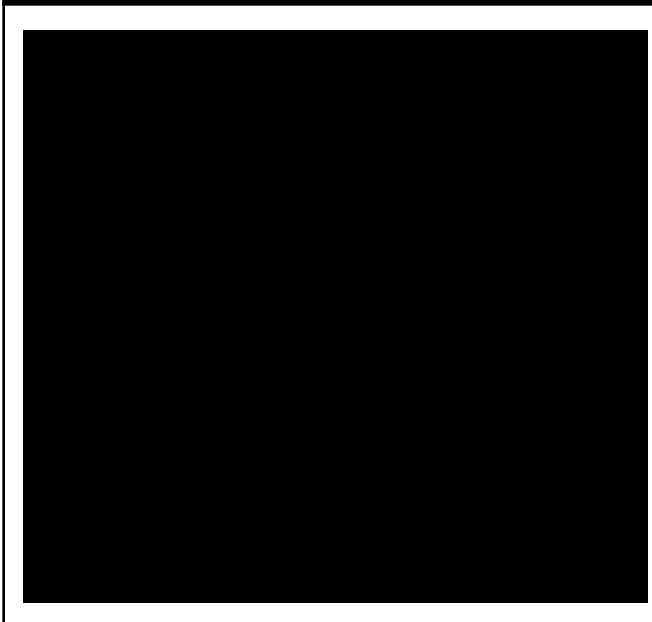

**Recommended Pad Layout for  
Surface Mount Leadform**



**Note**  
All dimensions are in inches (millimeters)



# LOW INPUT CURRENT PHOTOTRANSISTOR OPTOCOUPLEDERS

**MCT5200**

**MCT5201**

**MCT5210**

**MCT5211**

## ORDERING INFORMATION

Option	Order Entry Identifier	Description
S	.S	Surface Mount Lead Bend
SD	.SD	Surface Mount; Tape and Reel
W	.W	0.4" Lead Spacing
300	.300	VDE 0884
300W	.300W	VDE 0884, 0.4" Lead Spacing
3S	.3S	VDE 0884, Surface Mount
3SD	.3SD	VDE 0884, Surface Mount, Tape and Reel

## MARKING INFORMATION

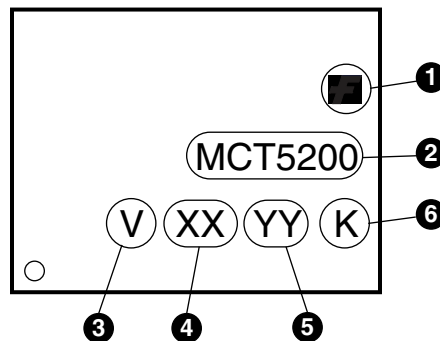

Definitions	
1	Fairchild logo
2	Device number
3	VDE mark (Note: Only appears on parts ordered with VDE option – See order entry table)
4	Two digit year code, e.g., '03'
5	Two digit work week ranging from '01' to '53'
6	Assembly package code

# LOW INPUT CURRENT PHOTOTRANSISTOR OPTOCOUPPLERS

MCT5200

MCT5201

MCT5210

MCT5211

## Carrier Tape Specifications



### NOTE

All dimensions are in inches (millimeters)

## Reflow Profile (Black Package, No Suffix)

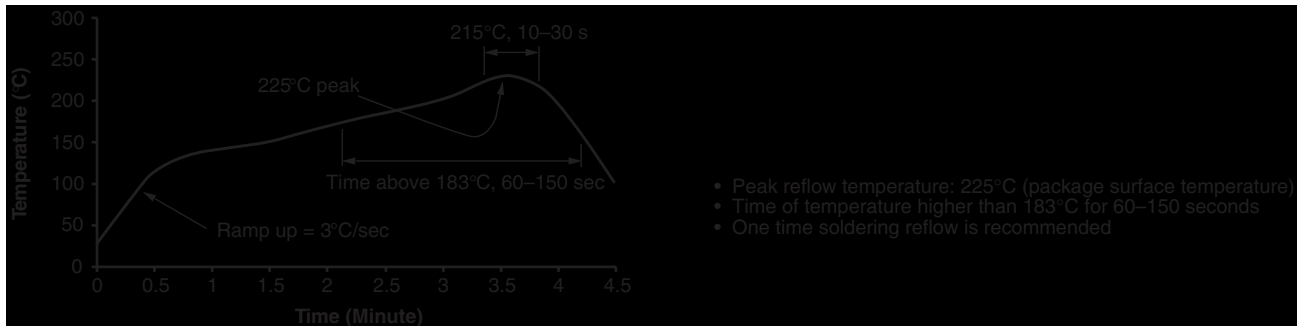



# LOW INPUT CURRENT PHOTOTRANSISTOR OPTOCOUPERS

---

**MCT5200****MCT5201****MCT5210****MCT5211**

---

**DISCLAIMER**

FAIRCHILD SEMICONDUCTOR RESERVES THE RIGHT TO MAKE CHANGES WITHOUT FURTHER NOTICE TO ANY PRODUCTS HEREIN TO IMPROVE RELIABILITY, FUNCTION OR DESIGN. FAIRCHILD DOES NOT ASSUME ANY LIABILITY ARISING OUT OF THE APPLICATION OR USE OF ANY PRODUCT OR CIRCUIT DESCRIBED HEREIN; NEITHER DOES IT CONVEY ANY LICENSE UNDER ITS PATENT RIGHTS, NOR THE RIGHTS OF OTHERS.

**LIFE SUPPORT POLICY**

FAIRCHILD'S PRODUCTS ARE NOT AUTHORIZED FOR USE AS CRITICAL COMPONENTS IN LIFE SUPPORT DEVICES OR SYSTEMS WITHOUT THE EXPRESS WRITTEN APPROVAL OF THE PRESIDENT OF FAIRCHILD SEMICONDUCTOR CORPORATION. As used herein:

1. Life support devices or systems are devices or systems which, (a) are intended for surgical implant into the body, or (b) support or sustain life, and (c) whose failure to perform when properly used in accordance with instructions for use provided in the labeling, can be reasonably expected to result in a significant injury of the user.
2. A critical component in any component of a life support device or system whose failure to perform can be reasonably expected to cause the failure of the life support device or system, or to affect its safety or effectiveness.