



SPECIFICATION FOR APPROVAL

Customer : _____

Description : DC FAN _____

Customer Part No. NA _____ REV. : _____

Delta Model No. : TCA1748BT-00P8 _____ REV. : 00 _____

Sample Issue No. : _____

Sample Issue Date : OCT.22 2020 _____

PLEASE SEND ONE COPY OF THIS SPECIFICATION BACK AFTER YOU SIGNED APPROVAL FOR PRODUCTION PRE-ARRANGMENT.

APPROVED BY:

DATE :

DELTA ELECTRONICS, INC.
TAOYUAN PLANT
252, SHANGYING ROAD, GUISHAN INDUSTRIAL ZONE,
TAOYUAN CITY 33341, TAIWAN
TEL:886-(0)3-3591968
FAX:886-(0)3-3591991

DELTA ELECTRONICS, INC.
252, SHANGYING ROAD, GUISHAN INDUSTRIAL ZONE,
TAOYUAN CITY 33341, TAIWAN

TEL : 886-(0)3-3591968
FAX : 886-(0)3-3591991

STATEMENT OF DEVIATION

NONE

DESCRIPTION:

DELTA ELECTRONICS, INC.
252, SHANGYING ROAD, GUISHAN INDUSTRIAL ZONE,
TAOYUAN CITY 33341, TAIWAN

TEL : 886-(0)3-3591968
FAX : 886-(0)3-3591991

Specification For Approval

Customer :

Description : DC FAN

Customer P/N :

rev. :

Delta model no. : TCA1748BT-00P8

Delta Safety Model No.: TCA1748BT-00

Sample revision. : 00

Issue no.:

Sample issue date : OCT.22 2020

Quantity :

1. SCOPE:

THIS SPECIFICATION DEFINES THE ELECTRICAL AND MECHANICAL CHARACTERISTICS OF THE DC BRUSHLESS CENTRIFUGAL BLOWER.

2. CHARACTERS:

ITEM	DESCRIPTION
RATED VOLTAGE	48.0 VDC
OPERATION VOLTAGE	36.0-60.0 VDC
INPUT CURRENT(AVG.)	2.80 (4.38 MAX.) A (SAFETY CURRENT ON LABEL : 5.88 A)
INPUT POWER(AVG.)	134.40 (210.00 MAX.) W
SPEED	5400 + 10% RPM
MAX. AIR FLOW (AT ZERO STATIC PRESSURE)	15.291(MIN. 13.762) M3 /MIN. 540.00 (MIN. 486.00) CFM
MAX. AIR PRESSURE (AT ZERO AIRFLOW)	96.50(MIN. 78.165) mmH2O 3.799 (MIN. 3.077) inchH2O
ACOUSTICAL NOISE (AVG.)	78.0 (MAX. 82.0) dB-A
INSULATION TYPE	UL: CLASS A
INSULATION STRENGTH	10 MEG OHM MIN. AT 500 VDC (BETWEEN FRAME AND (+) TERMINAL)
DIELECTRIC STRENGTH	5 mA MAX. AT 500 VAC 50/60 Hz ONE MINUTE, (BETWEEN FRAME AND (+) TERMINAL)

(continued)

PAGE 1

PART NO:

DELTA MODEL: TCA1748BT-00P8

LIFE EXPECTANCE (L10) AT LABEL VOLTAGE	70,000 HOURS CONTINUOUS OPERATION AT 40 °C WITH 15 ~ 65 %RH.
ROTATION	CLOCKWISE VIEW FROM NAME PLATE SIDE
LOCKED CURRENT SHUT DOWN	THE CURRENT WILL SHUT DOWN WHEN ROTOR LOCKED AND FIXED.

NOTES:

1. ALL READINGS ARE MEASURED AFTER STABLY WARMING UP THROUGH 10 MINUTES.
2. STANDARD AIR PROPERTY IS AIR AT (Td) 25°C TEMPERATURE, (RH) 65% RELATIVE HUMIDITY , AND (Pb) 760 mmHg BAROMETRIC PRESSURE.
3. THE VALUES WRITTEN IN PARENS , (), ARE LIMITED SPEC.
4. ACOUSTICAL NOISE MEASURING CONDITION:

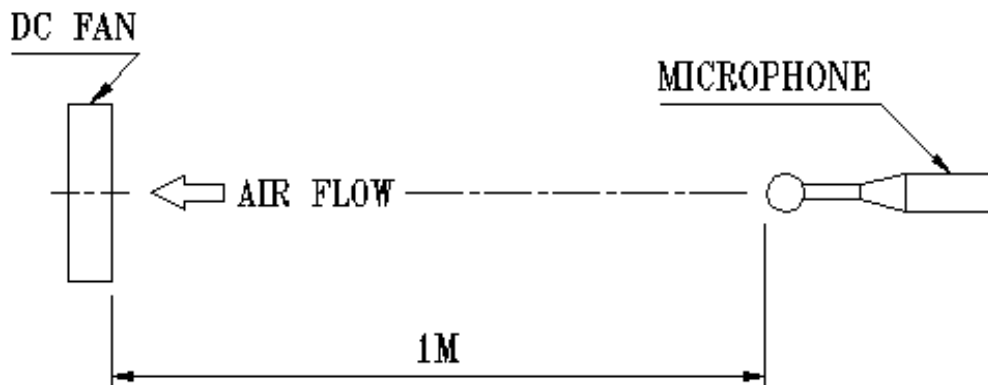

NOISE IS MEASURED AT RATED VOLTAGE IN FREE AIR IN SEMI-ANECHOIC CHAMBER WITH MICROPHONE AT A DISTANCE OF ONE METER FROM THE FAN INTAKE.

PART NO:

DELTA MODEL: TCA1748BT-00P8

3. MECHANICAL:

- 3-1. DIMENSIONS----- SEE DIMENSIONS DRAWING
- 3-2. FRAME----- ALUMINUM
- 3-3. IMPELLER----- PLASTIC BLACK UL: 94V-0(SECONDARY MATERIALS NOT ALLOWED)
- 3-4. BEARING SYSTEM----- TWO BALL BEARINGS
- 3-5. WEIGHT----- 820 GRAMS
- 3-6. ROTOR WEIGHT----- 430 GRAMS
- 3-7. INGRESS PROTECTION RATE

POTTING OR MOLDING PROCESS IS USED FOR STATOR & PCB ASSEMBLY PROTECTION. THE FAN RELIABILITY IS TESTED A RATING OF IP68 UNDER IEC STANDARD 60529. DETAILED TEST CONDITION PLEASE FIND IN ATTACH PAGE i.

4. ENVIRONMENTAL:

- 4-1. OPERATING TEMPERATURE----- -25 TO +75 DEGREE C
- 4-2. STORAGE TEMPERATURE----- -40 TO +75 DEGREE C
- 4-3. OPERATING HUMIDITY----- 5 TO 90 % RH
- 4-3-1. OPERATING HUMIDITY AT 40 °C ----- 5 TO 95 % RH
- 4-4. STORAGE HUMIDITY----- 5 TO 95 % RH

5. PROTECTION:

- 5-1. LOCKED ROTOR PROTECTION
IMPEDANCE OF MOTOR WINDING PROTECTS MOTOR FROM FIRE IN 96 HOURS OF LOCKED ROTOR CONDITION AT THE RATED VOLTAGE.
- 5-2. POLARITY PROTECTION
BE CAPABLE OF WITHSTANDING IF REVERSE CONNECTION FOR POSITIVE AND NEGATIVE LEADS.

6. RE OZONE DEPLETING SUBSTANCES:

- 6-1. NO CONTAINING PBBs, PBBOs, CFCs, PBBEs, PBDPEs AND HCFCs.

7. PRODUCTION LOCATION

- 7-1. PRODUCTS WILL BE PRODUCED IN CHINA OR THAILAND .

PART NO:

DELTA MODEL: TCA1748BT-00P8

8. P & Q CURVE:

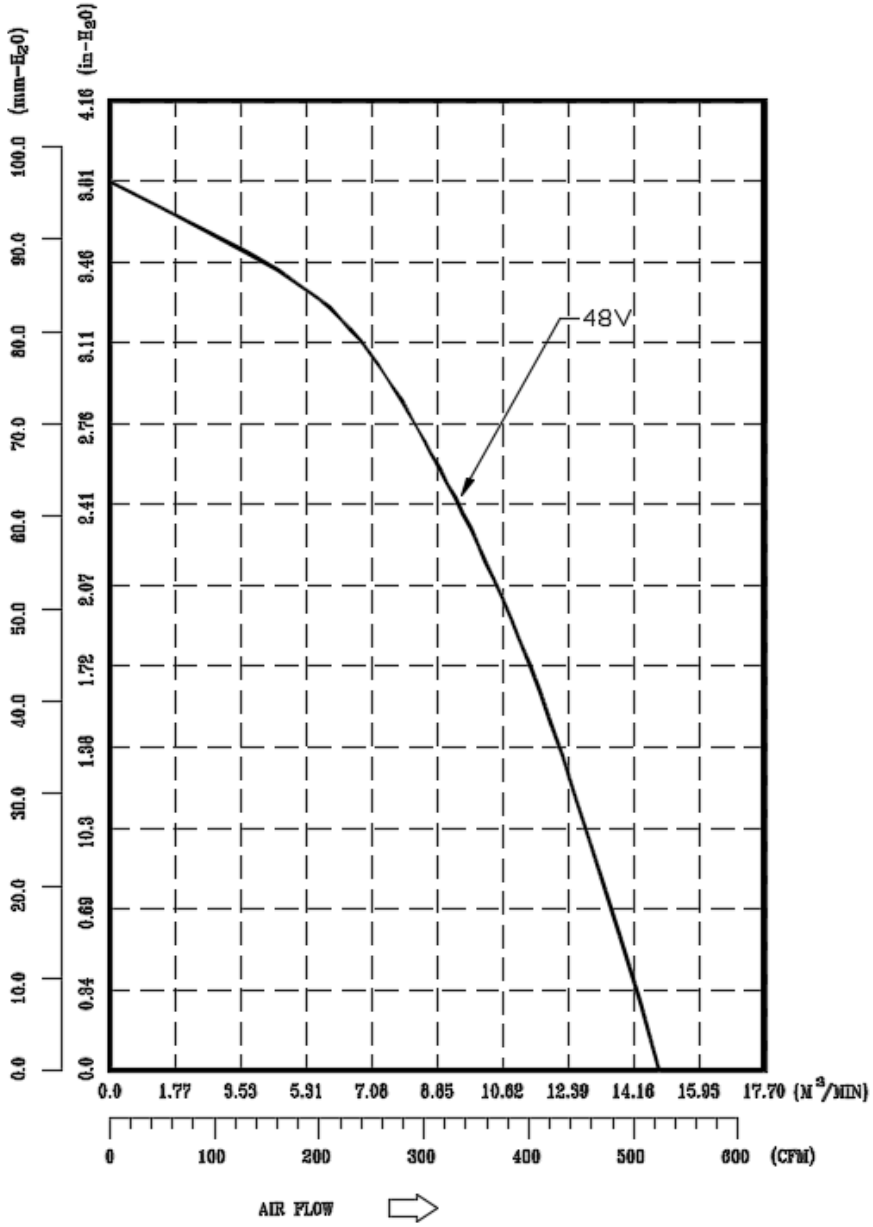

*TEST CONDITION: INPUT VOLTAGE-----OPERATION VOLTAGE
TEMPERATURE-----ROOM TEMPERATURE
HUMIDITY-----65%RH

PART NO:

DELTA MODEL: TCA1748BT-00P8

9. DIMENSION DRAWING:

LABEL:

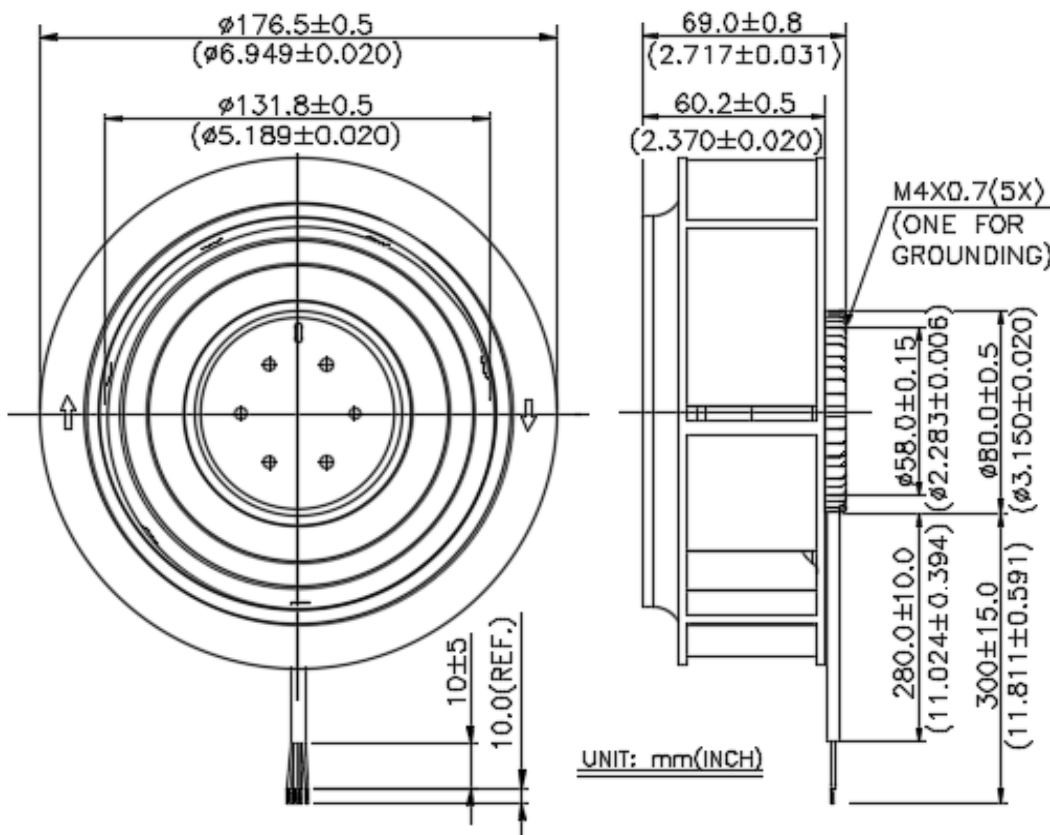
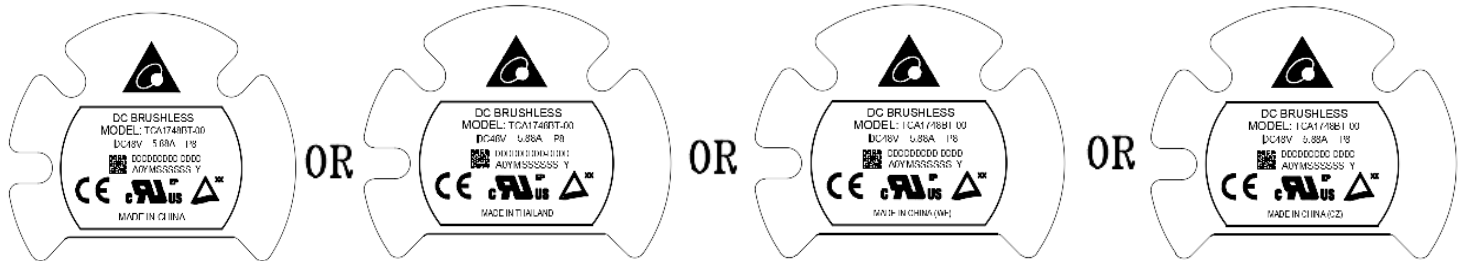

- NOTES: 1. CABLE WIRE UL:2517 AWG#20
PIN 1: RED WIRE -----(+)
PIN 2: YELLOW WIRE -----(PWM)
PIN 3: BLUE WIRE -----(FOO)
PIN 4: BLACK WIRE -----(−)

2. THIS PRODUCT IS RoHS COMPLIANT

PAGE 5

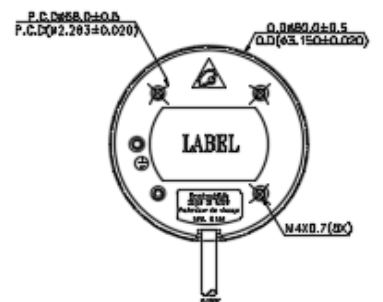

VIEW A of PILLOW

PART NO:

DELTA MODEL: TCA1748BT-00P8

10. FREQUENCY GENERATOR (FG) SIGNAL:

1. OUTPUT CIRCUIT - OPEN COLLECTOR MODE:

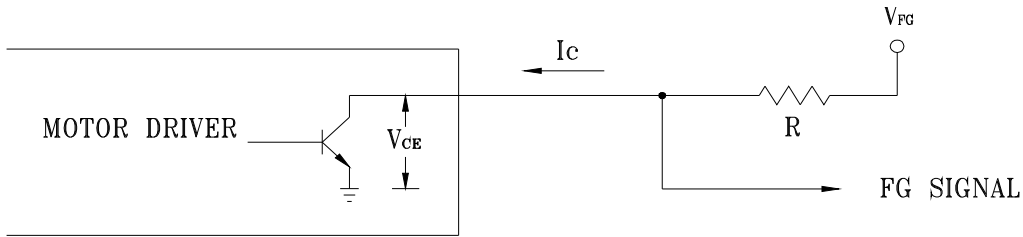

CAUTION:

THE LEAD WIRE OF FG SIGNAL CAN NOT TOUCH THE LEAD WIRE OF POSITIVE OR NEGATIVE.

2. SPECIFICATION:

$$V_{FG} = 60.0 \text{ V MAX.}$$

$$I_C = 10\text{mA MAX.}$$

$$V_{CE} (\text{sat}) = 0.5\text{V MAX.}$$

$$R \geq V_{FG} / I_C$$

3. FREQUENCY GENERATOR WAVEFORM:

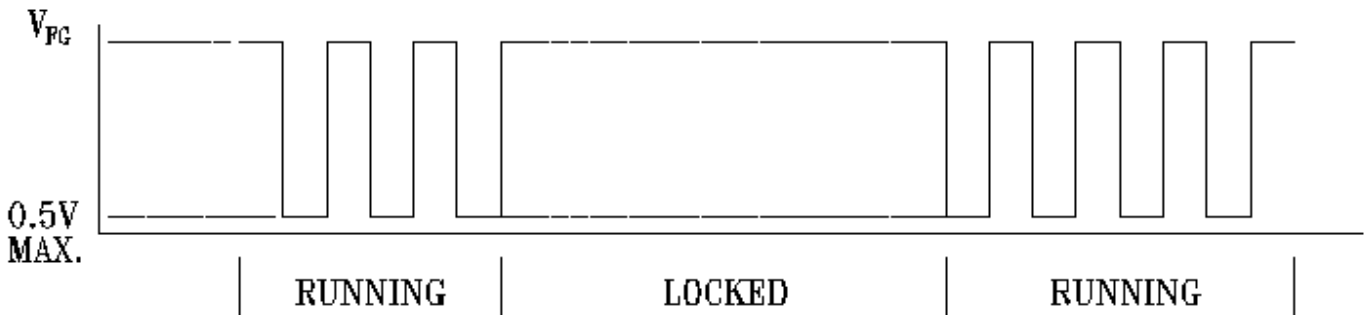

2 PULSES PER ROTATION

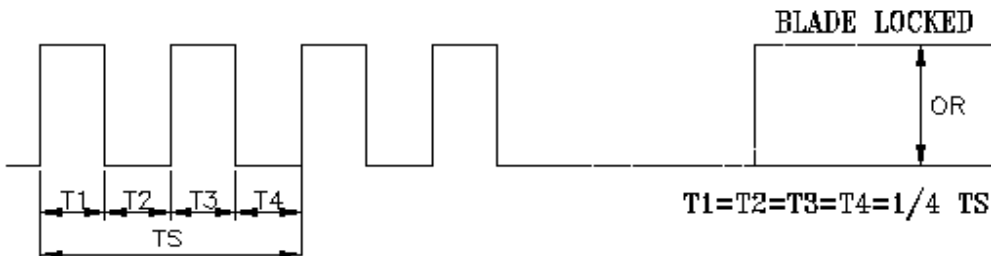

N=RPM

$TS = 60/N(\text{SEC})$

*VOLTAGE LEVEL AFTER BLADE LOCKED

*2 PULSES

PART NO:

DELTA MODEL: TCA1748BT-00P8

11. PWM CONTROL SIGNAL:

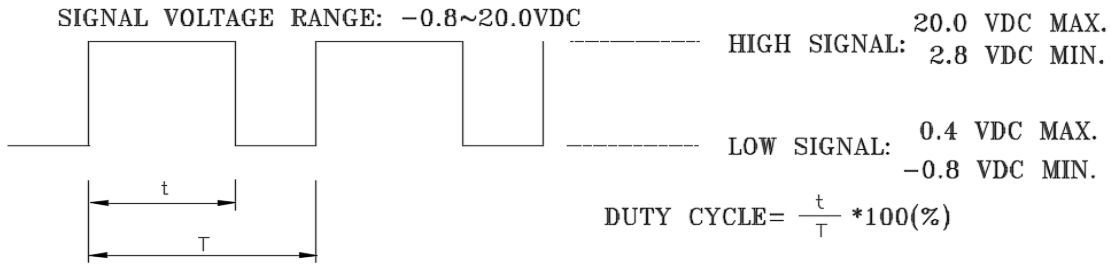

- *THE FREQUENCY FOR CONTROL SIGNAL OF THE FAN SHALL BE ABLE TO ACCEPT A 600Hz~30KHz.
- *THE PREFERRED OPERATING POINT FOR THE FAN IS 1KHz.
- *AT 100% DUTY CYCLE & 48VDC, THE ROTOR WILL SPIN AT MAXIMUM SPEED.
- *AT 0% DUTY CYCLE & 48VDC, THE ROTOR WILL STOP.
- *WITH CONTROL SIGNAL LEAD DISCONNECTED, THE FAN WILL SPIN AT MAXIMUM SPEED.
- *AT 48VDC 1KHz 30% DUTY CYCLE, THE FAN WILL BE ABLE TO START FROM A DEAD STOP .

12. SPEED VS PWM CONTROL SIGNAL: (AT 48VDC & F=1KHz & TEMP=25 DEG.C)

DUTY CYCLE (%)	SPEED RPM	CURRENT (A) TYP.
100	5400±10%	2.80
50	2900±10%	0.47
0	0	0.03

13. PWM CONTROL LEAD WIRE INPUT IMPEDANCE:

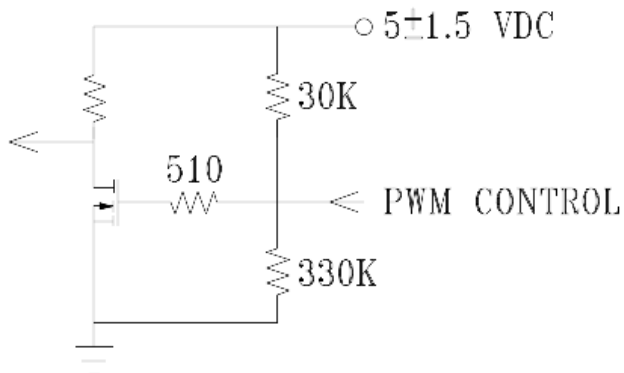

PART NO:

DELTA MODEL: TCA1748BT-00EHJ

Fan Characteristics Informations for Reference

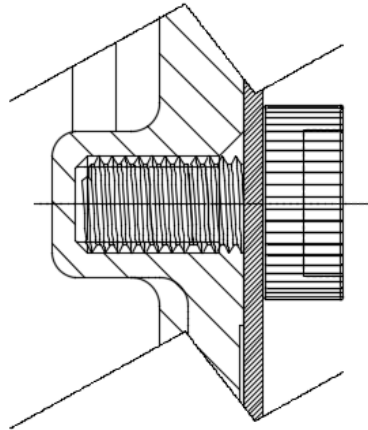
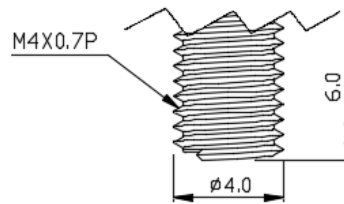
5. FRAME TYPE OF SCREW TORQUEMOUNTING DRAWINGMECHANICAL SCREW

MOUNTING HOLE DIAMETER	SCREW TYPE	SCREW SPEC.	RECOMMENDED MAX. TORQUE(kgf-cm)
M4	MECHANICAL	M4X0.7	10.0±10%

NOTE:



Q 1. MOUNTING HOLE TYPE.

2. MECHANICAL SCREW ACCORDING TO JIS B 0205.

Fan Characteristics Informations for Reference

IP68 INGRESS PROTECTION RATE

1. IP68 DEFINED IN ACCORDANCE WITH IEC60529 STANDARD
2. INGRESS PROTECTION LEVEL AND TEST CONDITION

First Characteristic numeral		Second Characteristic numeral		
6		Dust tight Wire		Continuous immersion

IP6X TEST CONDITION

Test Items	Test Conditions
Dust Test (IEC60529-IP6X)	1. Duration of test : 8 Hrs 2. Dust chamber (as IEC 60529 figure 2), with or without under pressure 3. With talcum powder, the talcum powder used shall be able to pass through a square-meshed sieve the nominal wire diameter of which is 50um and nominal width of gap between wires 75um 4. The amount of talcum powder to be used is 2kg per cubic meter of the test chamber volume 5. Powder shall not have been used for more than 20 tests

IPX8 TEST CONDITION

Test Items	Test Conditions
Rain, storage & running test (RNA-33) : IPX8-1 hrs	1. Refer to IEC60529 IP-X8 Test conditions: by optional 2. Test sample arrangement : 3 pcs test with rated voltage 3 pcs is non-operating 3. Sample direction : a. Shaft vertical & inlet up; b. Shaft vertical & inlet down; c. Shaft horizontal. 4. Immersion tank water level on enclosure : 1.1M above bottom 5. Test duration : 1 hrs 6. After final test, the samples need to place in the oven and to dry at 70°C / 2hrs

3. THE COMPONENT OF PCBA AND WINDING ASSY ARE COMPLETELY SEALED WITH RESIN. NOT INCLUDING BEARING AND SPRING
4. CAPACITOR EXPOSURE DOES NOT AFFECT THE IP6X GUARANTEE, BECAUSE THE SOLDER JOINTS ARE WELL PROTECTED BY RESIN, AND RESIN PART IS INTEGRAL, CAN BE CLAIMED TO MEET IP6X
5. THE FAN UNIT CAN BE CLAIMED TO MEET IPX8 TEST IS REQUIRED TO MEET FOLLOWING TEST CONDITION AND RESULT
- 5-1. POWER ON TEST ON FAN UNIT IS REQUIRED BUT FAN UNIT IS NOT REQUIRED MAINTAIN ROTATING AND HAVE POWER CONSUMPTION WHEN TESTING UNDER WATER
- 5-2. FAN UNIT NEED TO MEET SPEC FUNCTION AFTER RUNNING TEST UNDER WATER



Application Notice

- 1. Delta will not guarantee the performance of the products if the application condition falls outside the parameters set forth in the specification.**
- 2. A written request should be submitted to Delta prior to approval if deviation from this specification is required.**
- 3. Please exercise caution when handling fans. Damage may be caused when pressure is applied to the impeller, if the fans are handled by the lead wires, or if the fan was hard-dropped to the production floor.**
- 4. Except as pertains to some special designs, there is no guarantee that the products will be free from any such safety problems or failures as caused by the introduction of powder, droplets of water or encroachment of insect into the hub.**
- 5. The above-mentioned conditions are representative of some unique examples and viewed as the first point of reference prior to all other information.**
- 6. It is very important to establish the correct polarity before connecting the fan to the power source. Positive (+) and Negative (-). Damage may be caused to the fans if connection is with reverse polarity, if there is no foolproof method to protect against such error specifically mentioned in this spec.**
- 7. Delta fans without special protection are not suitable where any corrosive fluids are introduced to their environment.**
- 8. Please ensure all fans are stored according to the storage temperature limits specified. Do not store fans in a high humidity environment. We highly recommend performance testing is conducted before shipping, if the fans have been stored over 6 months.**
- 9. Not all fans are provided with the Lock Rotor Protection feature. If you impair the rotation of the impeller for the fans that do not have this function, the performance of those fans will lead to failure.**
- 10. Please be cautious when mounting the fan. Incorrect mounting of fans may cause excess resonance, vibration and subsequent noise.**
- 11. It is important to consider safety when testing the fans. A suitable fan guard should be fitted to the fan to guard against any potential for personal injury.**
- 12. Except where specifically stated, all tests are carried out at room (ambient) temperature and relative humidity conditions of 25°C, 65% RH. The test value is only for fan performance itself.**
- 13. Be certain to connect an “ 4.7μF or greater” capacitor to the fan externally when the application calls for using multiple fans in parallel, to avoid any unstable power.**