

MAX3806

Receiver for Optical Distance Measurement

General Description

The MAX3806 is a high-gain linear preamplifier for distance measurement applications using a laser beam.

The device operates from a single +5.0V supply and converts current from an AC-coupled photodiode into a single-ended voltage signal. The input accepts single pulses or bursts of pulses with widths down to 30ns. The amplifier remains linear with input amplitudes from 42nAp (SNR = 3) to 40μAp. It can also withstand overload signals as large as 2mAp. The output stage is designed to drive a high-impedance load to deliver the output-voltage swing at the lowest possible power dissipation. The gain of the preamplifier stage is selected using the GAIN pin to be 60kΩ or 30kΩ. There is also an internal 14dB attenuator that is selected using the ATT pin. The output stage can be disabled (high impedance).

The device is available in a 3mm x 3mm, 12-pin TQFN package and operates over the -40°C to +105°C temperature range.

Applications

- Laser Sensors for Portable Distance Measurement
- Laser Sensors for Industrial Applications

Benefits and Features

- +5V Supply Voltage
- Linearity Range Up to 40μAp
- Overload Current Up to 2mAp
- 50mW Power Dissipation at +5.0V
- 1.5pA/√Hz Noise Density at 60kΩ Gain
- 14nARMS Input-Referred Noise at 60kΩ Gain
- Selectable Gains (60kΩ, 30kΩ)
- Selectable 14dB Attenuation

Ordering Information

PART	TEMP RANGE	PIN-PACKAGE	TOP MARK
MAX3806GTC+	-40°C to +105°C	12 TQFN-EP*	ABN

+Denotes a lead(Pb)-free/RoHS-compliant package.

*EP = Exposed pad.

Pin Configuration appears at end of data sheet.

Typical Application Circuits

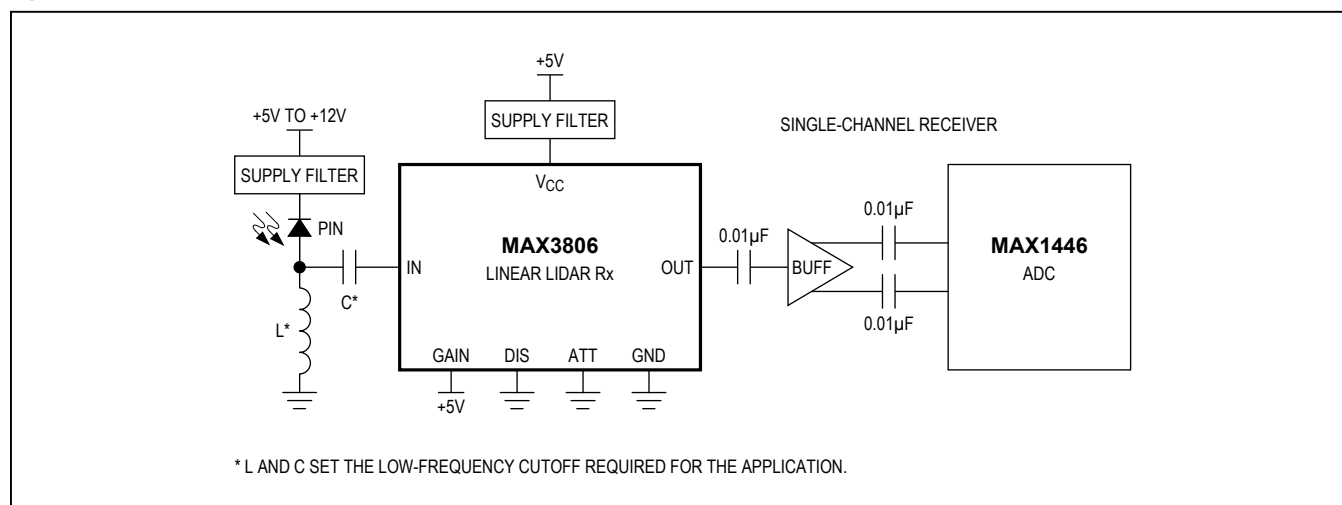

Typical Application Circuits continued at end of data sheet.

Absolute Maximum Ratings

Supply Voltage Range, V_{CC}.....-0.5V to +6.0V
 Voltage Range at ATT, DIS, GAIN.....-0.5V to (V_{CC} + 0.5V)
 Current Range at IN, OUT.....-4mA to +4mA

Continuous Power Dissipation (T_A = +70°C)
 12-Pin TQFN-EP (derate 16.7mW/°C above +70°C)...1333mW
 Storage Temperature Range-55°C to +150°C
 Lead Temperature (soldering, 10s)+300°C

Stresses beyond those listed under "Absolute Maximum Ratings" may cause permanent damage to the device. These are stress ratings only, and functional operation of the device at these or any other conditions beyond those indicated in the operational sections of the specifications is not implied. Exposure to absolute maximum rating conditions for extended periods may affect device reliability.

Electrical Characteristics

(V_{CC} = +4.5V to +5.5V, AC-coupled (C = 0.01µF) output load ≥ 2kΩ, T_A = -40°C to +105°C. Typical values are at V_{CC} = +5V, T_A = +25°C, unless otherwise noted.) (Note 1)

PARAMETER	SYMBOL	CONDITIONS		MIN	TYP	MAX	UNITS
Power-Supply Current	I _{CC}	(Note 2)			10	15	mA
INPUT SPECIFICATIONS							
Input-Referred Noise		Output noise up to 100MHz/(gain at 5MHz)	C _{IN} = 5pF, GAIN = 1		14	20	nA _{RMS}
			C _{IN} = 5pF, GAIN = 0		21	27	
Input-Referred Noise Density		Output noise centered at 5MHz over 100Hz band/(gain at 5MHz)	C _{IN} = 5pF, GAIN = 1		1.5	1.8	pA/√Hz
			C _{IN} = 5pF, GAIN = 0		1.7	2.3	
Input Impedance		At 1MHz, GAIN = 1			800		Ω
		At 1MHz, GAIN = 0			300		
CMOS/TTL INPUT SPECIFICATIONS							
Input High Voltage	V _{IH}			2		V _{CC}	V
Input Low Voltage	V _{IL}			0		0.8	V
Input Current	I _{IH} , I _{IL}	DIS input				±150	µA
	I _{IH}	GAIN and ATT inputs				-180	
Input Impedance	R _{PULLUP}	DIS input			60		kΩ
	R _{PULLDOWN}	GAIN and ATT inputs			40		
GENERAL SPECIFICATIONS							
Small-Signal Transimpedance		I _{IN} ≤ 15µAP, GAIN = 1		44	60	77	kΩ
		I _{IN} ≤ 50µAP, GAIN = 0		23	30	37	
Small-Signal Bandwidth	f _{3dB}	C _{IN} = 5pF	GAIN = 1, ATT = 0	25	49		MHz
			GAIN = 0, ATT = 0	55	98		
Gain Peaking		5pF ≤ C _{IN} ≤ 15pF			1		dB
Attenuation Stability		ATT = 1; 20log(V _{OUT_ATT_ON} /V _{OUT_ATT_OFF})		-13	-14	-15	dB
OUTPUT SPECIFICATIONS							
Total Harmonic Distortion	THD	Frequency = 1MHz, V _{OUT} = 0.5V _P	GAIN = 1		-54		dB
			GAIN = 0		-53		
		Frequency = 10MHz, V _{OUT} = 0.5V _P	GAIN = 1		-38		
			GAIN = 0		-47		
Power-Supply Noise Rejection GAIN = 1 -16 (Note 3)	PSNR	Noise frequency < 1MHz		GAIN = 1	-16		dB
				GAIN = 0	-23		

Electrical Characteristics (continued)

($V_{CC} = +4.5V$ to $+5.5V$, AC-coupled ($C = 0.01\mu F$) output load $\geq 2k\Omega$, $T_A = -40^\circ C$ to $+105^\circ C$. Typical values are at $V_{CC} = +5V$, $T_A = +25^\circ C$, unless otherwise noted.) (Note 1)

PARAMETER	SYMBOL	CONDITIONS	MIN	TYP	MAX	UNITS
Attenuation in Disable Mode		Frequency < 5MHz, $20\log(V_{OUT_DISABLED}/V_{OUT_ENABLED})$	ATT = 0		-71	dB
			ATT = 1		-57	
Output Impedance		At 1MHz, DIS = 0, ATT = 0, GAIN = 0 or 1			51	Ω
		At 1MHz, DIS = 0, ATT = 1, GAIN = 0 or 1			114	
		At 1MHz, DIS = 1, ATT = 0 or 1, GAIN = 0 or 1			9	k Ω

Note 1: AC specifications are guaranteed by design and characterization.

Note 2: Supply current is measured with OUT unterminated or AC-coupled.

Note 3: Measured by applying 100mV_{P-P} sinusoidal noise to the supply voltage. PSNR is defined as $20\log(V_{OUT_NOISE}/V_{CC_NOISE})$.

Typical Operating Characteristics

(Typical values are at $V_{CC} = +5V$, $T_A = +25^\circ C$, $C_{IN} = 5pF$, ATT = 0, unless otherwise noted.)

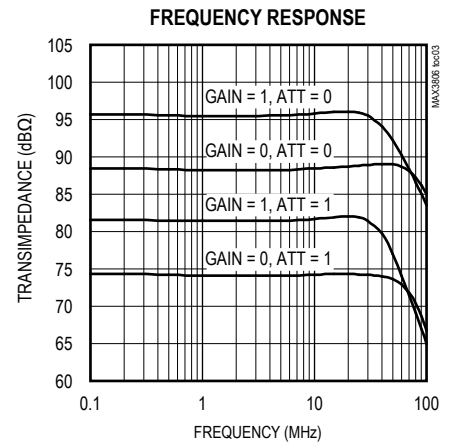
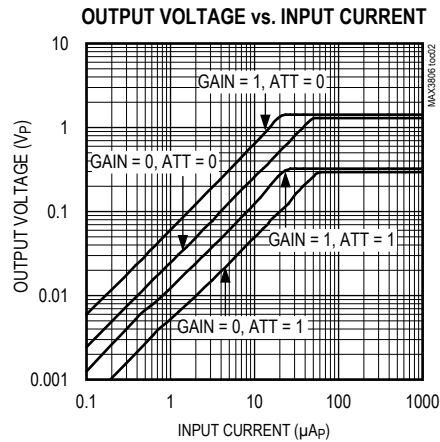
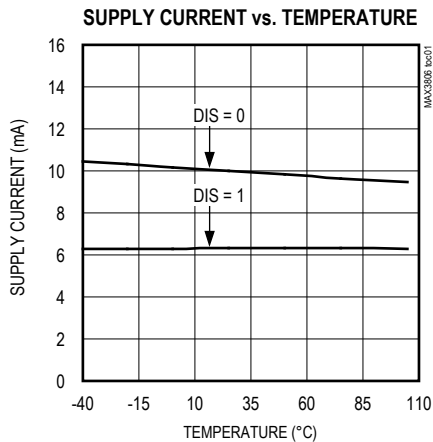

Typical Operating Characteristics (continued)

(Typical values are at $V_{CC} = +5V$, $T_A = +25^\circ C$, $C_{IN} = 5pF$, $ATT = 0$, unless otherwise noted.)

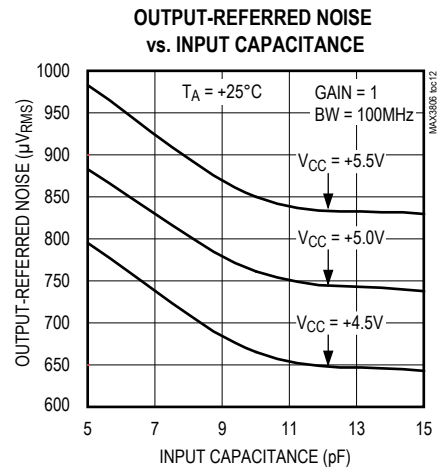
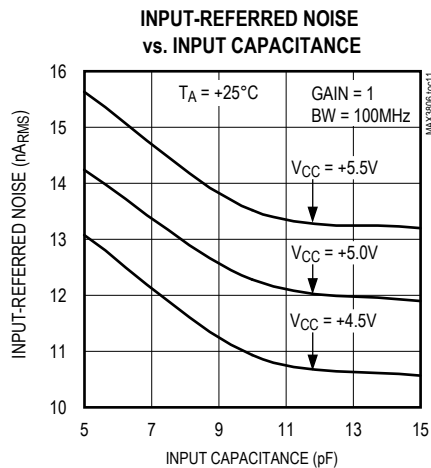
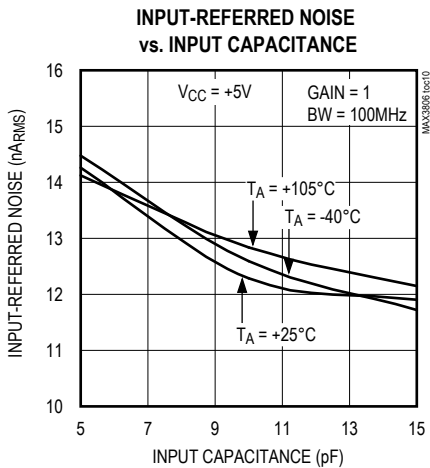
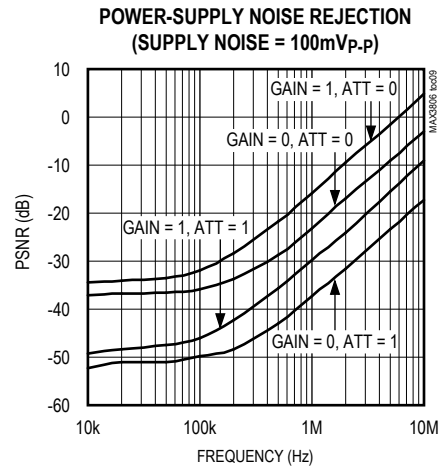
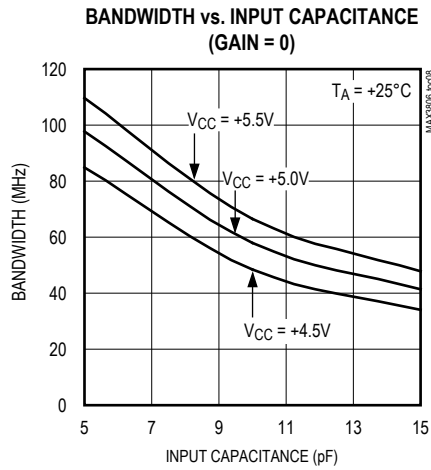
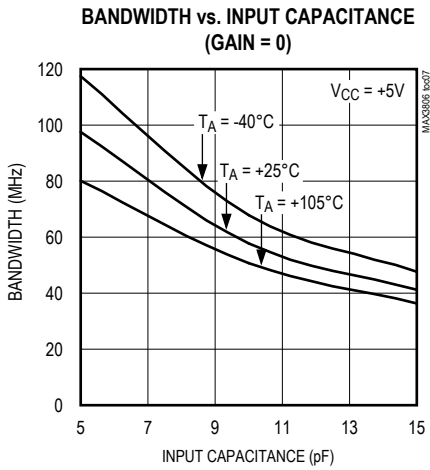
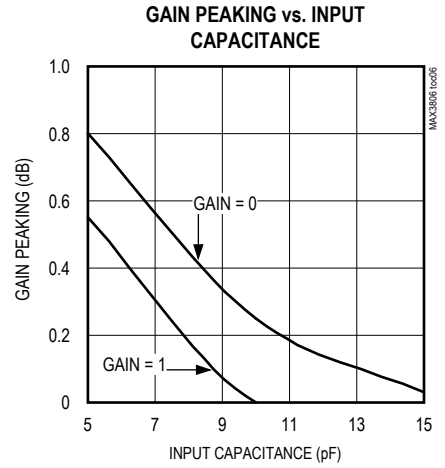
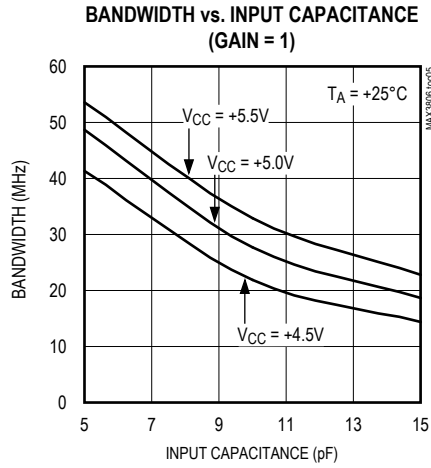
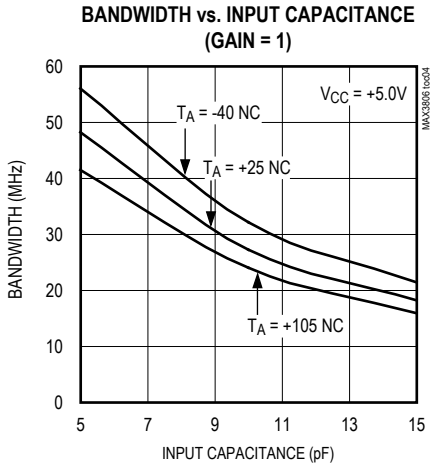

Typical Operating Characteristics (continued)

(Typical values are at $V_{CC} = +5V$, $T_A = +25^\circ C$, $C_{IN} = 5pF$, $ATT = 0$, unless otherwise noted.)

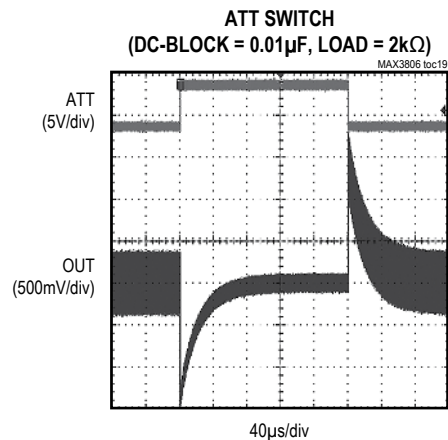
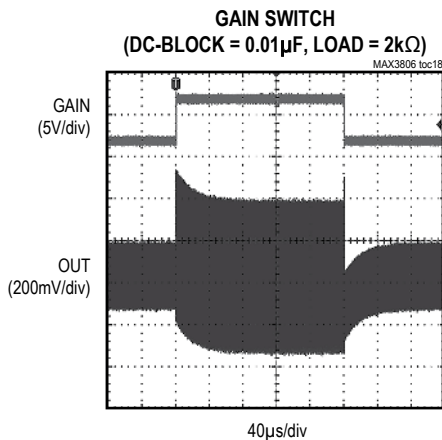
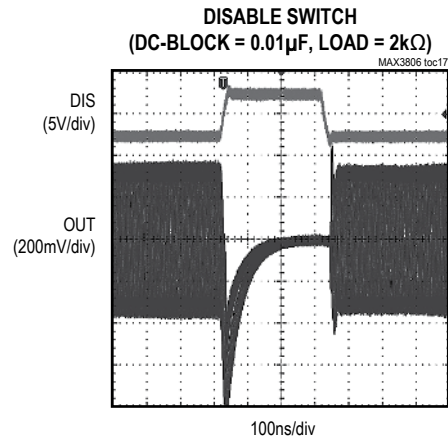
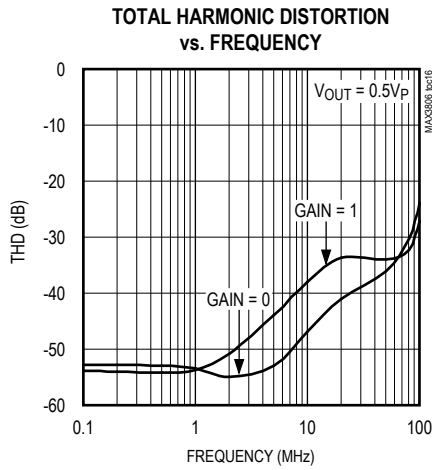
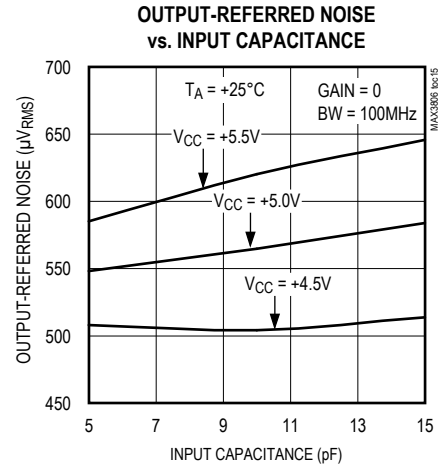
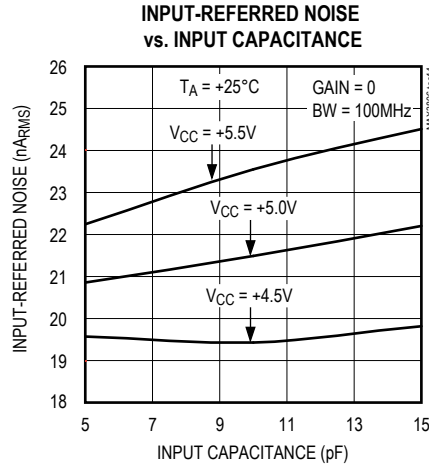
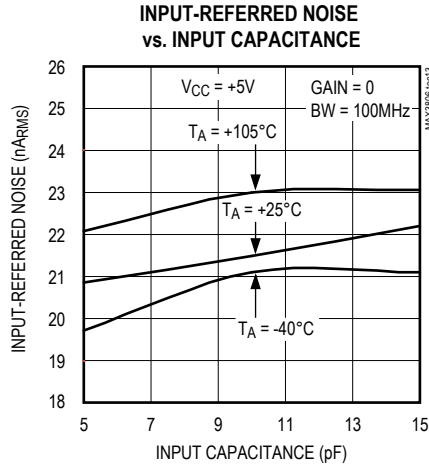

Typical Operating Characteristics (continued)

(Typical values are at $V_{CC} = +5V$, $T_A = +25^{\circ}C$, $C_{IN} = 5pF$, $ATT = 0$, unless otherwise noted.)

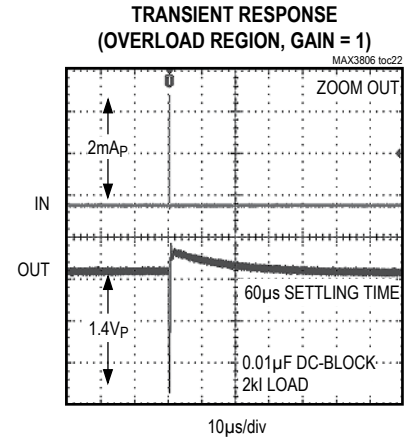
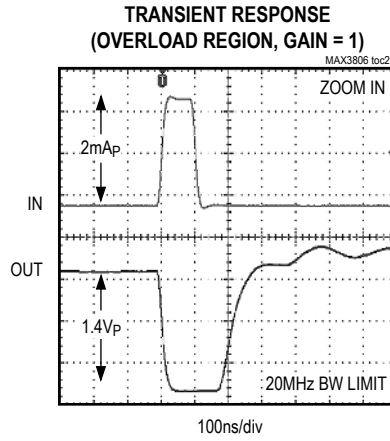
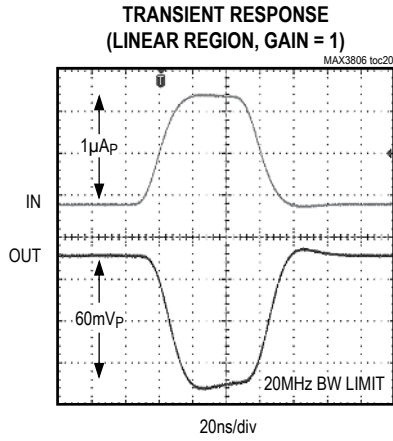

Functional Diagram

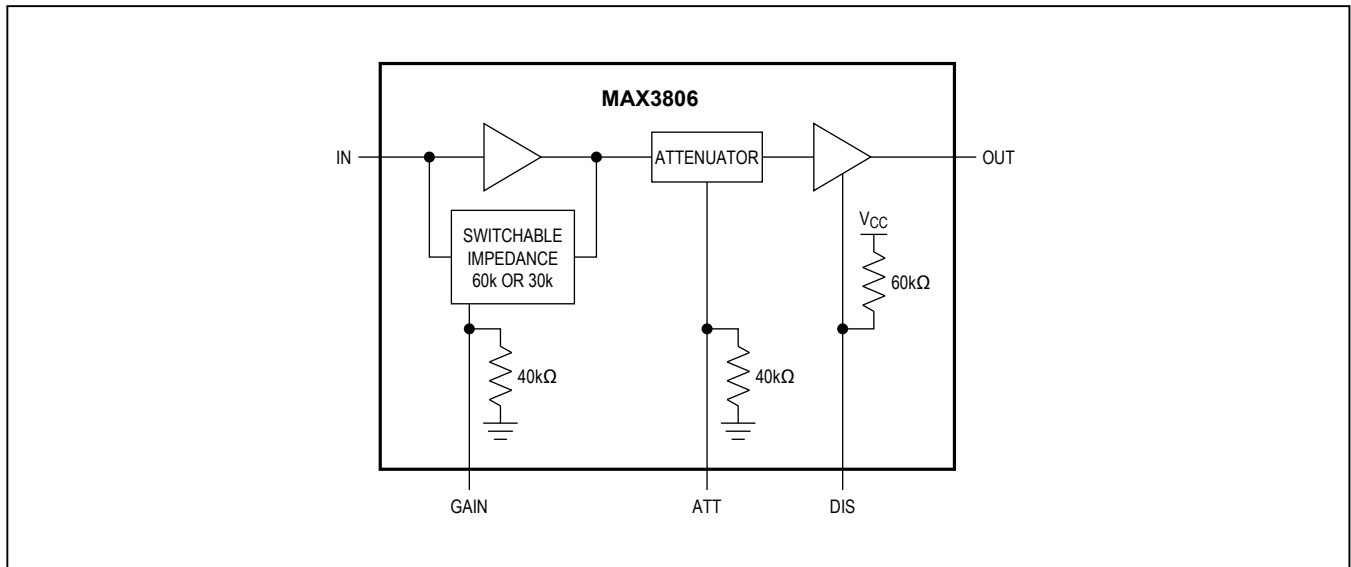

Pin Description

PIN	NAME	FUNCTION
1, 12	V _{CC}	5V Power-Supply Connection
2	IN	Amplifier Input. Accepts AC-coupled photodiode input current.
3, 4	GND	Supply Ground
5	ATT	CMOS/TTL Input. Assert this pin high to enable a 14dB attenuator in the amplifier. Force this pin low to disable the attenuator. Contains internal 40kΩ pull-down resistor. Connect to GND if not used.
6, 8, 11	N.C.	Not Connected. This pin is not internally connected.
7	GAIN	CMOS/TTL Input. Selects amplifier gain setting. Force high for 60kΩ. Force low for 30kΩ. Contains internal 40kΩ pull-down resistor.
9	OUT	Amplifier Output. An increase in current into the IN pin causes the voltage at the OUT pin to decrease. OUT must be AC-coupled to a load of 2kΩ or greater.
10	DIS	CMOS/TTL Input. Force high to disable the output of the MAX3806. Force low to enable the output. Contains internal 60kΩ pull-up resistor.
—	EP	Exposed Pad. The exposed pad must be soldered to circuit board ground for proper thermal and electrical performance.

Detailed Description

The MAX3806 preamplifier consists of a selectable-gain transimpedance amplifier, a selectable 14dB attenuator, and an output-driver block. The selectable-gain transimpedance amplifier linearly boosts the signal from the photodiode. This block is followed by an attenuator block that allows the user to attenuate the signal by 14dB selected by the ATT pin. The final block is the output driver that can be disabled by asserting the DIS pin.

Transimpedance Amplifier

The selectable-gain transimpedance amplifier is controlled by the GAIN pin. See Table 1 for gain settings.

Attenuator

The attenuator block can be set to pass the signal through to the output stage with 0dB of attenuation (ATT forced low) or with 14dB of attenuation (ATT forced high).

Output Driver

The output driver is designed to drive an AC-coupled load with an impedance of 2kΩ or greater. The output can be disabled by asserting the DIS pin high. When the output is disabled, the OUT pin goes to a high-impedance state. See Figure 1 for the equivalent output circuit.

WARNING: The output is designed to be AC-coupled to a high-impedance load. Operating the part with its output DC-coupled to GND through a 2kΩ or less load may damage the output.

Applications Information

Settling Time

Settling time is the required time for the output to achieve the final steady-state or AC amplitude swing after a setting has been changed on the MAX3806. The output common-mode voltage shifts when a change is made

Table 1. Transimpedance Gain Settings

GAIN	TRANSIMPEDANCE (kΩ)	LINEAR RANGE (μA _p)	BANDWIDTH (MHz)
0	30	I _{IN} ≤ 40	98
1	60	I _{IN} ≤ 20	49

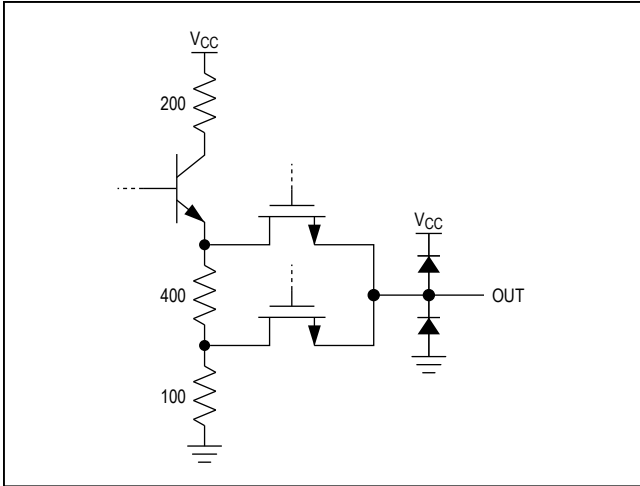

Figure 1. Equivalent Output Circuit

to either the GAIN or ATT setting. Table 2 provides typical output common-mode voltages for the combination of settings. Settling time is proportional to the RC time constant set by the output DC-blocking capacitor, load, and MAX3806 output impedance. For example, a 0.01μF DC-blocking capacitor, 2kΩ load, and 51Ω output impedance provide an RC time constant of approximately 20μs. After changing the GAIN or ATT setting, the system should wait at least three to four time constants before analyzing received signals.

Settling time is also required when changing the DIS setting. When DIS is asserted high, the output disables to high impedance and typically settles to steady state within 200ns. When DIS is deasserted, the output enables and typically settles to steady state within 50ns.

Overload Recovery Time

Transistors saturate when the amplifier is overloaded, resulting in output distortion. Overload typically occurs with signals greater than 20μA_p (GAIN = 1) or 40μA_p (GAIN = 0). It can withstand overload signals as large as 2mA_p. Recovery time depends on the amplitude and duration of the overload pulse.

Table 2. Output Common-Mode Voltages

GAIN	ATT	OUTPUT COMMON-MODE VOLTAGE (V)
0	0	1.65
0	1	0.33
1	0	1.82
1	1	0.36

Layout Considerations

Noise performance and bandwidth are adversely affected by capacitance at the IN pad. Minimize capacitance on this pad and select a low-capacitance photodiode. Reducing PCB capacitance can be accomplished by removing the ground plane underneath the connection from the photodiode to the IN pin and by keeping the photodiode as close as possible to the MAX3806.

Use broadband power-supply filtering techniques to achieve the best sensitivity and noise performance.

Exposed-Pad Package and Thermal Considerations

The exposed pad on the 12-pin TQFN provides a very low thermal resistance path for heat removal from the IC. The pad is also electrical ground on the MAX3806 and must be soldered to the circuit board ground for proper thermal and electrical performance. Refer to Application Note 862: HFAN-08.1: Thermal Considerations of QFN and Other Exposed-Paddle Packages for additional information.

Pin Configuration

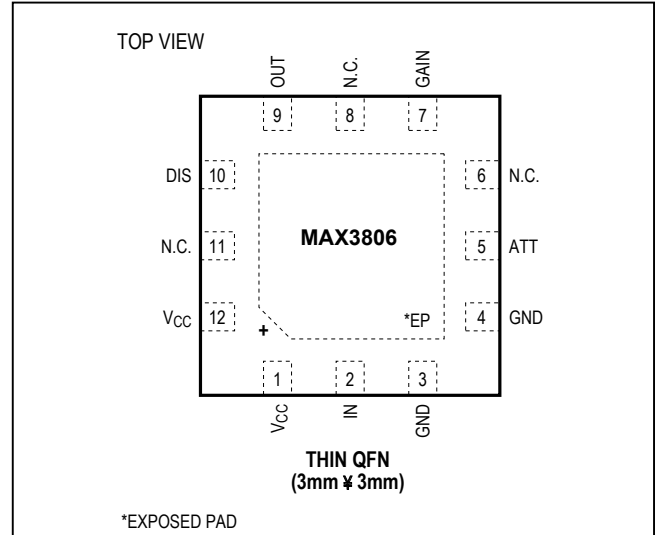

Package Information

For the latest package outline information and land patterns (footprints), go to www.maximintegrated.com/packages. Note that a "+", "#", or "-" in the package code indicates RoHS status only. Package drawings may show a different suffix character, but the drawing pertains to the package regardless of RoHS status.

PACKAGE TYPE	PACKAGE CODE	OUTLINE NO.	LAND PATTERN NO.
12 TQFN-EP	T1233+3	21-0136	90-0018

Typical Application Circuits (continued)

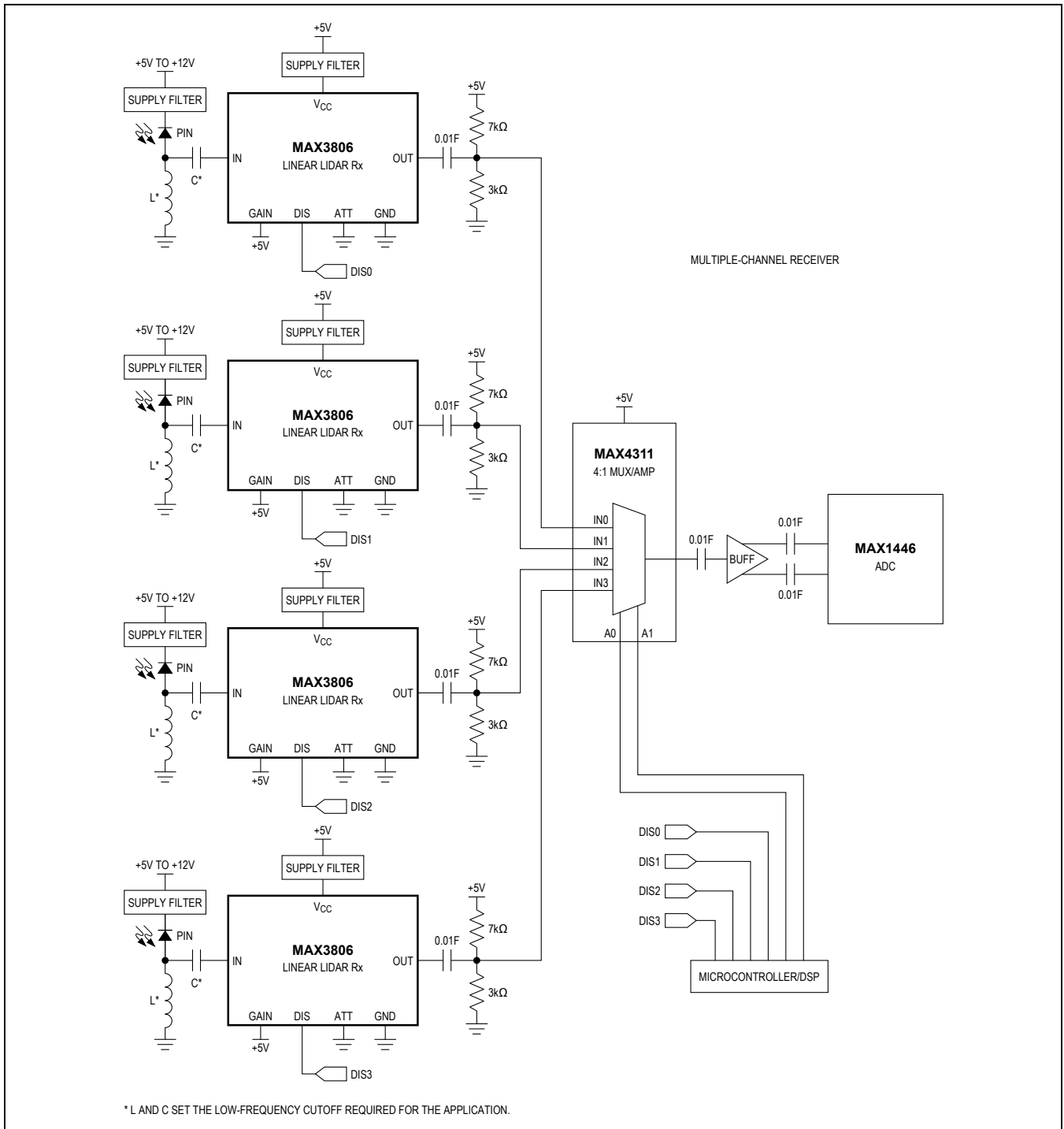

Revision History

REVISION NUMBER	REVISION DATE	DESCRIPTION	PAGES CHANGED
0	7/09	Initial release	—
1	6/14	Removed automotive reference from <i>Applications</i> section and corrected page code	1, 8

For pricing, delivery, and ordering information, please contact Maxim Direct at 1-888-629-4642, or visit Maxim Integrated's website at www.maximintegrated.com.

Maxim Integrated cannot assume responsibility for use of any circuitry other than circuitry entirely embodied in a Maxim Integrated product. No circuit patent licenses are implied. Maxim Integrated reserves the right to change the circuitry and specifications without notice at any time. The parametric values (min and max limits) shown in the Electrical Characteristics table are guaranteed. Other parametric values quoted in this data sheet are provided for guidance.