

ASMT-Jx1x

1W Mini Power LED Light Source



Description

This Broadcom[®] 1W Mini Power LED Light Source is a high-performance energy-efficient device that can handle high thermal and high driving current. An option with an electrically isolated metal slug is also available.

The White Mini Power LED is available in the range of color temperatures from 2700K to 10,000K.

The low-profile package design and ultra small footprint is suitable for a wide variety of applications especially where space and height is a constraint.

The package is compatible with reflow soldering process. To facilitate easy pick-and-place assembly, the LEDs are packed in EIA-compliant tape and reel.

Features

- Available in red, amber, blue, royal blue, cyan, green, cool white, and neutral white
- Small footprint
- Energy efficient
- Direct heat transfer from metal slug to motherboard
- Compatible with reflow soldering process
- High current operation
- Long operation life
- Wide viewing angle
- Silicone encapsulation
- Non-ESD sensitive (threshold > 16 kV)
- MSL 1 products

Applications

- Architectural lighting
- Garden lighting
- Decorative lighting
- Sign backlight
- Safety, exit and emergency sign lightings
- Specialty lighting such as task lighting and reading lights
- Retail display
- Commercial lighting
- Accent or marker lightings, strip, or step lightings
- Portable lightings, bicycle head lamp, torch lights
- Pathway lighting
- Street lighting
- Tunnel lighting

CAUTION! Keep the LEDs in the MBB when not in use because prolonged exposure to environment might cause the silver plated leads to tarnish, which might cause difficulties in soldering.

Figure 1: ASMT-Jx1x Package Outline Drawing

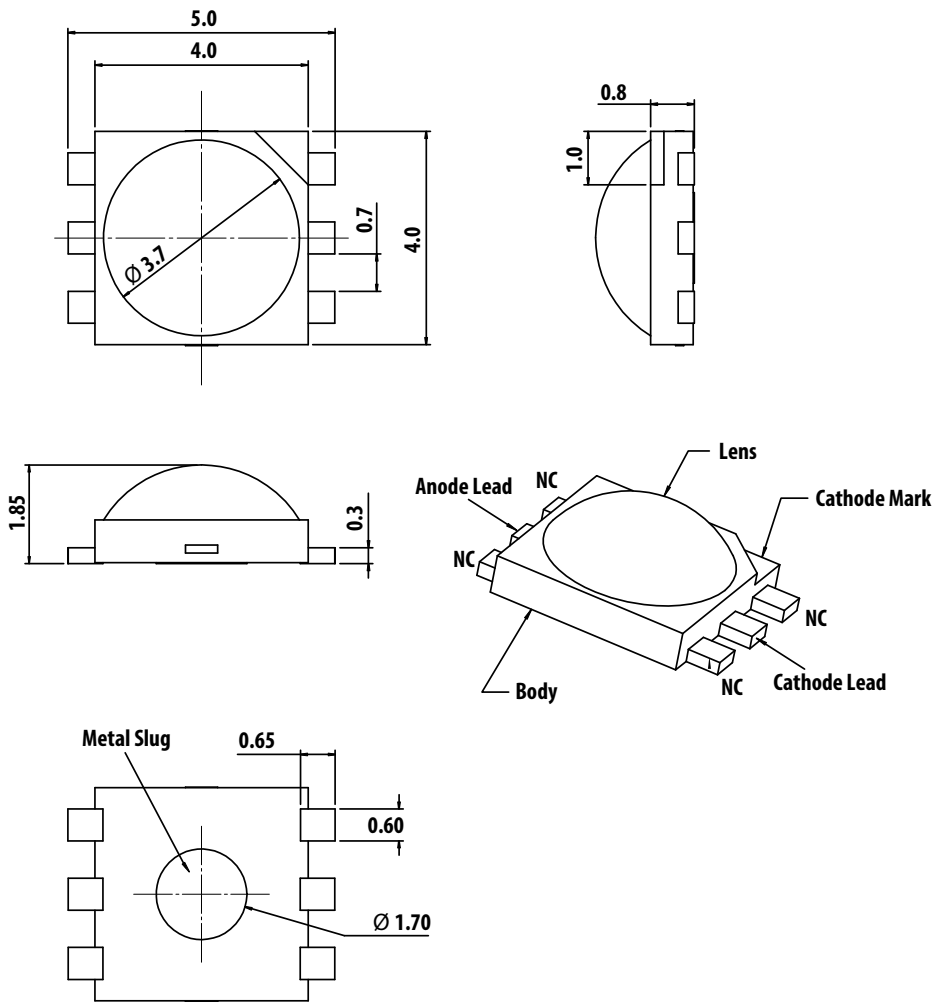
**NOTE:**

1. All dimensions are in millimeters.
2. Metal slug is connected to anode for electrically non-isolated option.
3. Tolerance is ± 0.1 mm unless otherwise specified.
4. Terminal finish: Ag plating.
5. Corresponding NC (No Connection) leads adjacent to anode and cathode leads can be electrically short.

Device Selection Guide ($T_J = 25^\circ\text{C}$)

| Part Number | Color | Luminous Flux (lm) / Radiometric Power (mW), $\Phi_V^{a, b}$ | | | Test Current (mA) | Dice Technology | Electrically Isolated Metal Slug |
|-----------------|---------------|--|--------|--------|-------------------|-----------------|----------------------------------|
| | | Min. | Typ. | Max. | | | |
| ASMT-JR10-AST01 | Red | 51.7 | 62.0 | 87.4 | 350 | AllnGaP | No |
| ASMT-JA10-ARS01 | Amber | 39.8 | 48.0 | 67.2 | 350 | AllnGaP | No |
| ASMT-JB11-NNQ01 | Blue | 18.1 | 24.0 | 39.8 | 350 | InGaN | Yes |
| ASMT-JL11-NQS01 | Royal Blue | 435 mW | 550 mW | 685 mW | 350 | InGaN | Yes |
| ASMT-JC11-NTU01 | Cyan | 67.2 | 75.0 | 99.6 | 350 | InGaN | Yes |
| ASMT-JG11-NUW01 | Green | 87.4 | 110.0 | 129.5 | 350 | InGaN | Yes |
| ASMT-JW11-NWX01 | Cool White | 113.6 | 120.0 | 147.7 | 350 | InGaN | Yes |
| ASMT-JN11-NWX01 | Neutral White | 113.6 | 120.0 | 147.7 | 350 | InGaN | Yes |

a. Φ_V is the total luminous flux/radiometric power output as measured with an integrating sphere at 25-ms mono pulse condition.

b. Flux tolerance is $\pm 10\%$.

Absolute Maximum Ratings

| Parameter | AllnGaP | InGaN | InGaN Cyan | Units |
|--|-------------------------------|-------------|-------------|------------------|
| DC Forward Current ^a | 500 | 500 | 500 | mA |
| Peak Pulsing Current ^b | 1000 | 1000 | 1000 | mA |
| Power Dissipation | 1230 | 1830 | 1980 | mW |
| LED Junction Temperature | 125 | 150 | 150 | $^\circ\text{C}$ |
| Operating Metal Slug Temperature Range at 350 mA | -40 to +115 | -40 to +135 | -40 to +135 | $^\circ\text{C}$ |
| Storage Temperature Range | -40 to +120 | -40 to +120 | -40 to +120 | $^\circ\text{C}$ |
| Soldering Temperature | See Figure 28 | | | |
| Reverse Voltage ^c | Not recommended | | | |

a. Derate linearly based on [Figure 12](#) and [Figure 13](#) for AllnGaP and [Figure 24](#) and [Figure 25](#) for InGaN.

b. Pulse condition duty factor = 10%, frequency = 1 kHz.

c. Not recommended for reverse bias operation.

Optical Characteristics at 350 mA ($T_J = 25^\circ\text{C}$)

| Part Number | Color | Peak Wavelength, λ_{PEAK} (nm) | Dominant Wavelength, λ_D^a (nm) | Viewing Angle, $2\theta_{1/2}^b$ (°) | Luminous Efficiency (lm/W) |
|-----------------|------------|---|---|--------------------------------------|----------------------------|
| | | Typ. | Typ. | Typ. | Typ. |
| ASMT-JR10-AST01 | Red | 635 | 625 | 165 | 84 |
| ASMT-JA10-ARS01 | Amber | 598 | 590 | 165 | 65 |
| ASMT-JG11-NUW01 | Green | 519 | 525 | 165 | 98 |
| ASMT-JC11-NTU01 | Cyan | 497 | 500 | 165 | 63 |
| ASMT-JB11-NNQ01 | Blue | 454 | 460 | 165 | 21 |
| ASMT-JL11-NQS01 | Royal Blue | 450 | 455 | 165 | Not applicable |

a. The dominant wavelength, λ_D , is derived from the CIE Chromaticity Diagram and represents the color of the device.

b. $\theta_{1/2}$ is the off-axis angle where the luminous intensity is half of the peak intensity.

| Part Number | Color | Correlated Color Temperature, CCT (Kelvin) | | Viewing Angle, $2\theta_{1/2}^a$ (°) | Luminous Efficiency (lm/W) |
|-----------------|---------------|--|-------|--------------------------------------|----------------------------|
| | | Min. | Max. | Typ. | Typ. |
| ASMT-JW11-NWX01 | Cool White | 4500 | 10000 | 140 | 107 |
| ASMT-JN11-NWX01 | Neutral White | 3500 | 4500 | 140 | 107 |

a. $\theta_{1/2}$ is the off-axis angle where the luminous intensity is half of the peak intensity.

Electrical Characteristic at 350 mA ($T_J = 25^\circ\text{C}$)

| Dice Type | Forward Voltage, V_F (Volts) | | | Thermal Resistance, $R_{\theta j-ms}$ ($^\circ\text{C}/\text{W}$) ^a |
|-------------------------|--------------------------------|------|------|--|
| | Min. | Typ. | Max. | Typ. |
| AllnGaP | 1.7 | 2.1 | 2.3 | 9 |
| InGaN (non-Cyan Colors) | 2.8 | 3.2 | 3.5 | 9 |
| InGaN Cyan | 2.6 | 3.0 | 3.8 | 9 |

a. $R_{\theta j-ms}$ is thermal resistance from LED junction to metal slug.

Part Numbering System

A S M T - J x₁ 1 x₂ - x₃ x₄ x₅ x₆ x₇

| Code | Description | Option | |
|----------------|---------------------|---|---------------------------|
| x ₁ | Color | R | Red |
| | | A | Amber |
| | | G | Green |
| | | B | Blue |
| | | L | Royal Blue |
| | | W | Cool White |
| | | N | Neutral White |
| x ₂ | Heat sink | 0 | Electrically Non Isolated |
| | | 1 | Electrically Isolated |
| x ₃ | Dice Type | N | InGaN |
| | | A | AllnGaP |
| x ₄ | Minimum Flux Bin | See Flux/Power Bin Limit (x₄, x₅) | |
| x ₅ | Maximum Flux Bin | | |
| x ₆ | Color Bin Selection | See Color Bin Selection (x₆) | |
| x ₇ | Packaging Option | 0 | Tube |
| | | 1 | Tape and Reel |

Bin Information

Flux/Power Bin Limit (x₄, x₅)

| Color | Bin ID | Luminous Flux (lm)/Radiometric Power (mW) at 350 mA | |
|--------------|--------|---|-------|
| | | Min. | Max. |
| Blue | M | 13.9 | 18.1 |
| | N | 18.1 | 23.5 |
| | P | 23.5 | 30.6 |
| | Q | 30.6 | 39.8 |
| Other Colors | R | 39.8 | 51.7 |
| | S | 51.7 | 67.2 |
| | T | 67.2 | 87.4 |
| | U | 87.4 | 99.6 |
| | V | 99.6 | 113.6 |
| | W | 113.6 | 129.5 |
| | X | 129.5 | 147.7 |
| Royal Blue | M | 225.0 | 275.0 |
| | N | 275.0 | 355.0 |
| | P | 355.0 | 435.0 |
| | Q | 435.0 | 515.0 |
| | R | 515.0 | 595.0 |
| | S | 595.0 | 685.0 |

Tolerance for each bin limit is $\pm 10\%$.

Color Bin Selection (x₆)

Individual reel will contain parts from one color bin selection only.

Cool White

| Selection | Bin ID |
|-----------|------------------------|
| 0 | Full Distribution |
| E | VM, UM, VN, and UN |
| F | WM, VM, WN, and VN |
| G | XM, WM, XN, and WN |
| H | UN, VN, U0, and V0 |
| J | WN, VN, W0, and V0 |
| K | XN, WN, X0, and W0 |
| L | V0, U0, VP, and UP |
| M | W0, V0, WP, VP, and WQ |
| N | X0, W0, XP, WP, and WQ |
| P | Y0 |
| Q | YA |

Neutral White

| Selection | Bin ID |
|-----------|--------------------|
| 0 | Full Distribution |
| E | SM, RM, S1, and R1 |
| F | TM, SM, TN, and S1 |
| G | S1, R1, S0, and R0 |
| H | TN, S1, T0, and S0 |
| J | S0, R0, SA, and RA |
| K | T0, S0, TP, and SA |

Other Colors

| Selection | Bin ID |
|-----------|-------------------|
| 0 | Full Distribution |
| Z | A and B |
| Y | B and C |
| W | C and D |
| V | D and E |
| Q | A, B, and C |
| P | B, C, and D |
| N | C, D, and E |
| M | D, E, and F |

Figure 2: Color Bin Structure for Cool White

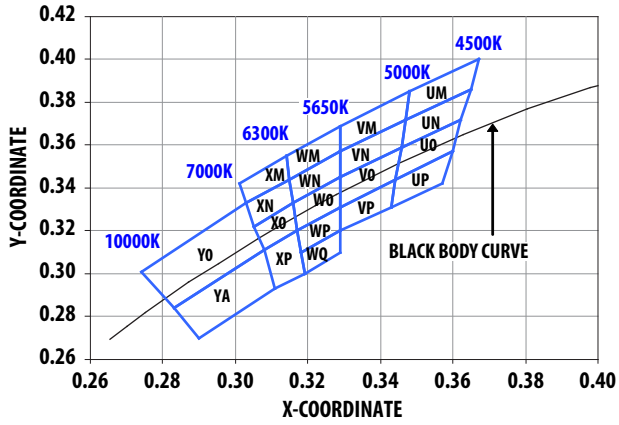
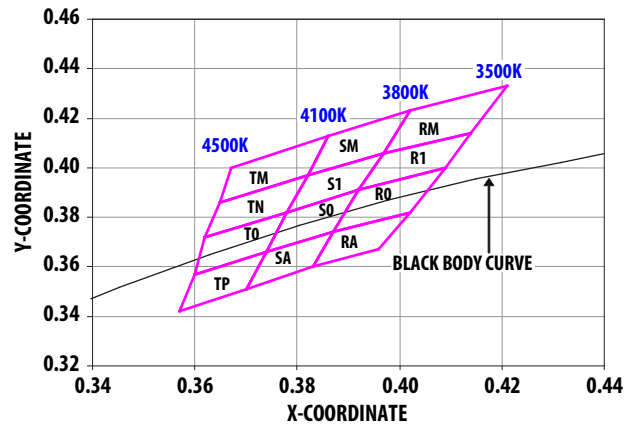

Figure 3: Color Bin Structure for Neutral White



Color Bin Limits

| Cool White | Color Limits (Chromaticity Coordinates) | | | | |
|------------|---|-------|-------|-------|-------|
| Bin UM | x | 0.365 | 0.348 | 0.347 | 0.367 |
| | y | 0.386 | 0.385 | 0.372 | 0.400 |
| Bin UN | x | 0.365 | 0.362 | 0.346 | 0.347 |
| | y | 0.386 | 0.372 | 0.359 | 0.372 |
| Bin U0 | x | 0.362 | 0.360 | 0.344 | 0.346 |
| | y | 0.372 | 0.357 | 0.344 | 0.359 |
| Bin UP | x | 0.360 | 0.357 | 0.343 | 0.344 |
| | y | 0.357 | 0.342 | 0.311 | 0.344 |
| Bin VM | x | 0.329 | 0.329 | 0.348 | 0.347 |
| | y | 0.357 | 0.369 | 0.385 | 0.372 |
| Bin VN | x | 0.329 | 0.329 | 0.347 | 0.346 |
| | y | 0.345 | 0.357 | 0.372 | 0.359 |
| Bin V0 | x | 0.329 | 0.329 | 0.346 | 0.344 |
| | y | 0.331 | 0.345 | 0.359 | 0.344 |
| Bin VP | x | 0.329 | 0.344 | 0.343 | 0.329 |
| | y | 0.331 | 0.344 | 0.331 | 0.320 |
| Bin WM | x | 0.329 | 0.329 | 0.315 | 0.314 |
| | y | 0.369 | 0.357 | 0.344 | 0.355 |
| Bin WN | x | 0.329 | 0.316 | 0.315 | 0.329 |
| | y | 0.345 | 0.333 | 0.344 | 0.357 |
| Bin W0 | x | 0.329 | 0.329 | 0.317 | 0.316 |
| | y | 0.345 | 0.331 | 0.320 | 0.333 |
| Bin WP | x | 0.329 | 0.329 | 0.318 | 0.317 |
| | y | 0.331 | 0.320 | 0.310 | 0.320 |
| Bin WQ | x | 0.329 | 0.329 | 0.319 | 0.318 |
| | y | 0.320 | 0.310 | 0.300 | 0.310 |
| Bin XM | x | 0.301 | 0.314 | 0.315 | 0.303 |
| | y | 0.342 | 0.355 | 0.344 | 0.333 |
| Bin XN | x | 0.305 | 0.303 | 0.315 | 0.316 |
| | y | 0.322 | 0.333 | 0.344 | 0.333 |
| Bin X0 | x | 0.308 | 0.305 | 0.316 | 0.317 |
| | y | 0.311 | 0.322 | 0.333 | 0.320 |
| Bin XP | x | 0.308 | 0.317 | 0.319 | 0.311 |
| | y | 0.311 | 0.320 | 0.300 | 0.293 |
| Bin Y0 | x | 0.308 | 0.283 | 0.274 | 0.303 |
| | y | 0.311 | 0.284 | 0.301 | 0.333 |
| Bin YA | x | 0.308 | 0.311 | 0.290 | 0.283 |
| | y | 0.311 | 0.293 | 0.270 | 0.284 |

Tolerance: ± 0.01 .

| Neutral White | Color Limits (Chromaticity Coordinates) | | | | |
|---------------|---|-------|-------|-------|-------|
| Bin RM | x | 0.421 | 0.414 | 0.397 | 0.402 |
| | y | 0.433 | 0.414 | 0.406 | 0.423 |
| Bin R1 | x | 0.414 | 0.409 | 0.392 | 0.397 |
| | y | 0.414 | 0.400 | 0.391 | 0.406 |
| Bin R0 | x | 0.392 | 0.387 | 0.402 | 0.409 |
| | y | 0.391 | 0.374 | 0.382 | 0.400 |
| Bin RA | x | 0.387 | 0.383 | 0.396 | 0.402 |
| | y | 0.374 | 0.360 | 0.367 | 0.382 |
| Bin SM | x | 0.402 | 0.397 | 0.382 | 0.386 |
| | y | 0.423 | 0.406 | 0.397 | 0.413 |
| Bin S1 | x | 0.397 | 0.392 | 0.378 | 0.382 |
| | y | 0.406 | 0.391 | 0.382 | 0.397 |
| Bin S0 | x | 0.392 | 0.387 | 0.374 | 0.378 |
| | y | 0.391 | 0.374 | 0.366 | 0.382 |
| Bin SA | x | 0.387 | 0.383 | 0.370 | 0.374 |
| | y | 0.374 | 0.360 | 0.351 | 0.366 |
| Bin TM | x | 0.386 | 0.382 | 0.365 | 0.367 |
| | y | 0.413 | 0.397 | 0.386 | 0.400 |
| Bin TN | x | 0.382 | 0.378 | 0.362 | 0.365 |
| | y | 0.397 | 0.382 | 0.372 | 0.386 |
| Bin T0 | x | 0.378 | 0.374 | 0.360 | 0.362 |
| | y | 0.382 | 0.366 | 0.357 | 0.372 |
| Bin TP | x | 0.374 | 0.370 | 0.357 | 0.360 |
| | y | 0.366 | 0.351 | 0.342 | 0.357 |

Tolerance: ± 0.01 .

Packaging Option (x₇)

| Selection | Option |
|-----------|---------------|
| 1 | Tape and Reel |

| Color | Bin ID | Dominant Wavelength (nm) at 350 mA | |
|-------|--------|------------------------------------|-------|
| | | Min. | Max. |
| Red | — | 620.0 | 635.0 |
| Amber | B | 587.0 | 589.5 |
| | C | 589.5 | 592.0 |
| | D | 592.0 | 594.5 |
| | E | 594.5 | 597.0 |
| Blue | A | 455.0 | 460.0 |
| | B | 460.0 | 465.0 |
| | C | 465.0 | 470.0 |
| | D | 470.0 | 475.0 |
| Cyan | C | 490.0 | 495.0 |
| | D | 495.0 | 500.0 |
| | E | 500.0 | 505.0 |
| | F | 505.0 | 510.0 |
| | G | 510.0 | 515.0 |
| | H | 515.0 | 520.0 |
| Green | A | 515.0 | 520.0 |
| | B | 520.0 | 525.0 |
| | C | 525.0 | 530.0 |
| | D | 530.0 | 535.0 |

Tolerance: ± 1 nm.

| Color | Bin ID | Peak Wavelength (nm) at 350 mA | |
|------------|--------|--------------------------------|-------|
| | | Min. | Max. |
| Royal Blue | C | 440.0 | 445.0 |
| | D | 445.0 | 450.0 |
| | E | 450.0 | 455.0 |
| | F | 455.0 | 460.0 |

Tolerance: ± 2 nm.

Example

ASMT-JW11-NWX01

ASMT-JW11-Nxxxx – Cool White, InGaN, Electrically isolated Heat Sink

- X₄ = W – Minimum Flux Bin W
- X₅ = X – Maximum Flux Bin X
- X₆ = 0 – Full Distribution
- X₇ = 1 – Tape and Reel Option

AlInGaP

Figure 4: Relative Intensity vs. Wavelength for Red and Amber

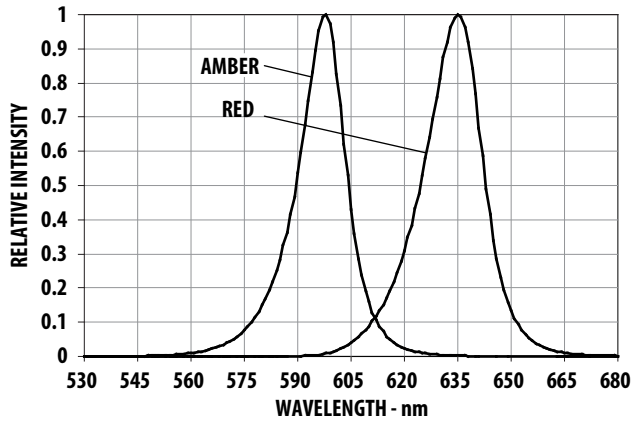

Figure 5: Relative Luminous Flux vs. Mono Pulse Current

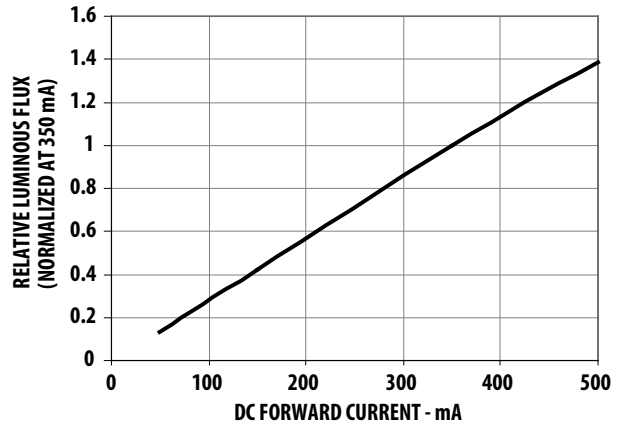

Figure 6: Forward Current vs. Forward Voltage

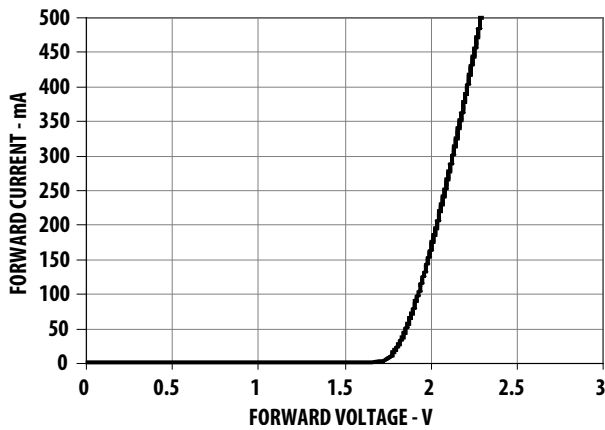

Figure 7: Radiation Pattern for Red and Amber

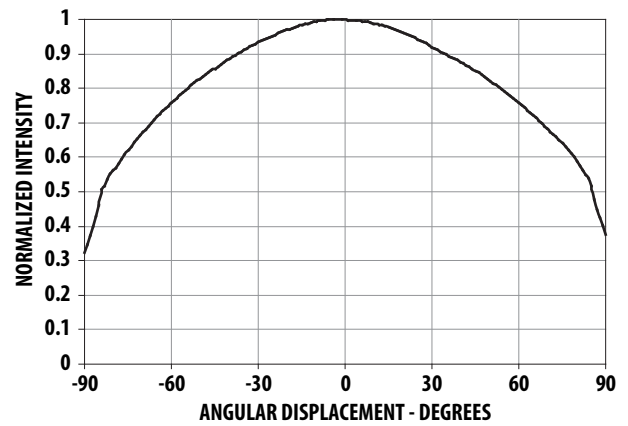

Figure 8: Maximum Pulse Current vs. Ambient Temperature. Derated based on $T_A = 25^\circ\text{C}$, $R_{\theta J-A} = 50^\circ\text{C/W}$.

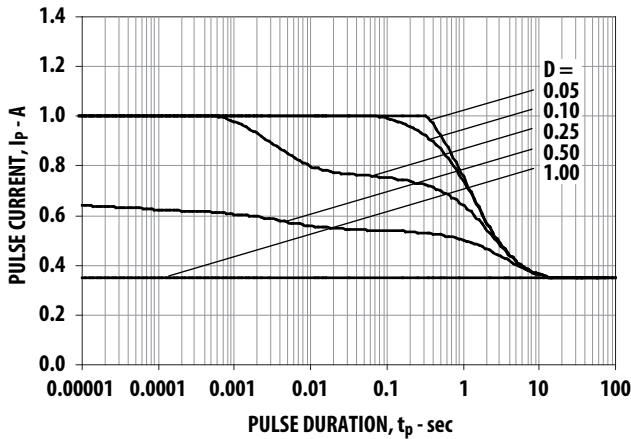
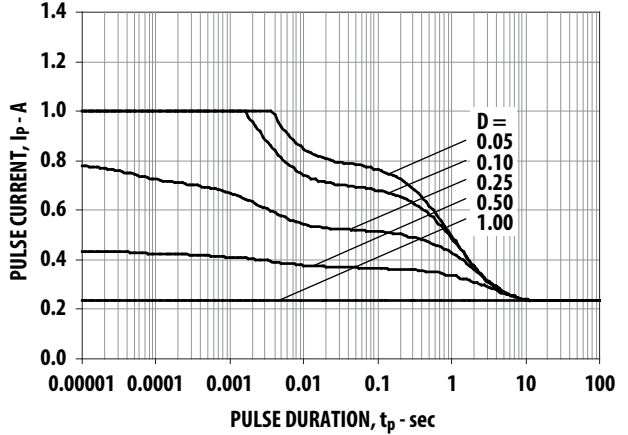

Figure 9: Maximum Pulse Current vs. Ambient Temperature. Derated based on $T_A = 85^\circ\text{C}$, $R_{\theta J-A} = 50^\circ\text{C/W}$.



AlInGaP

Figure 10: Relative Light Output vs. Junction Temperature

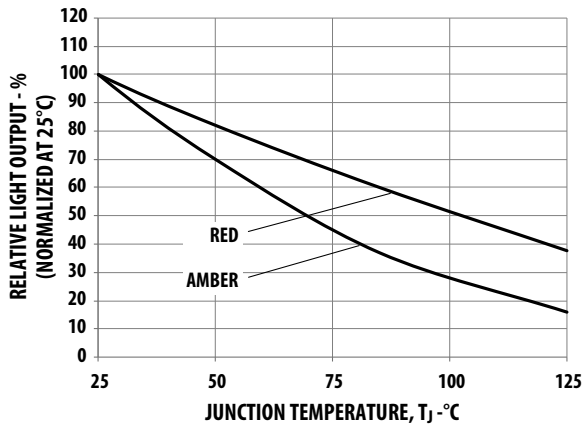

Figure 11: Forward Voltage Shift vs. Junction Temperature

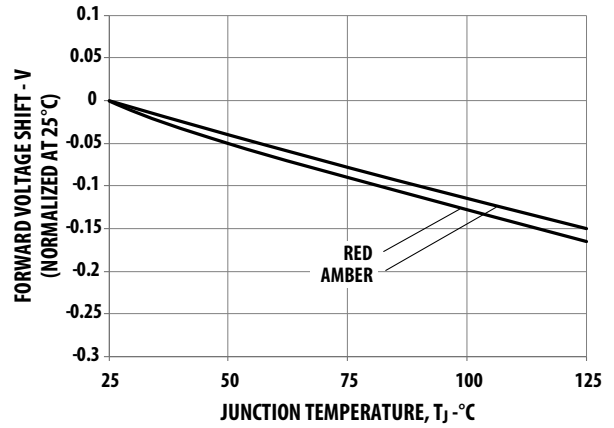

Figure 12: Maximum Forward Current vs. Ambient Temperature. Derated based on $T_{JMAX} = 125^\circ\text{C}$, $R_{\theta J-A} = 30^\circ\text{C/W}$, 40°C/W , and 50°C/W .

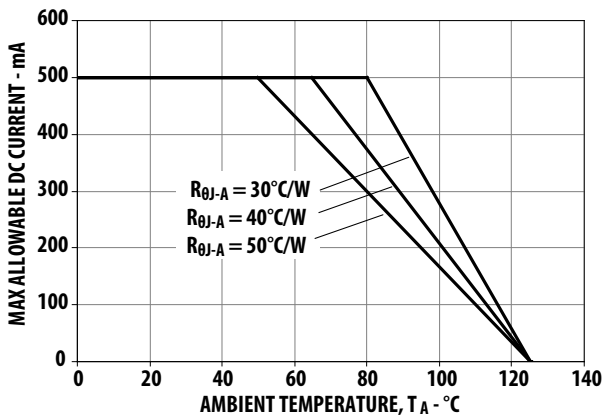
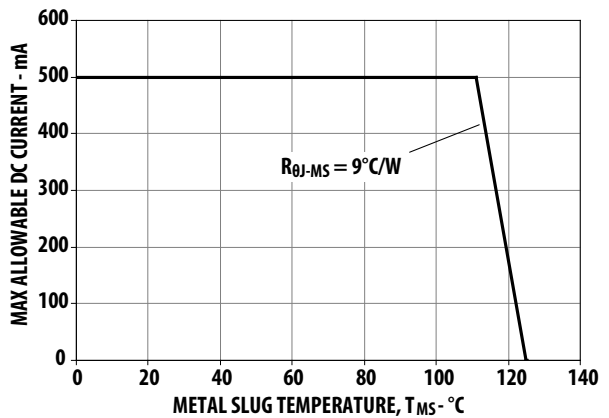

Figure 13: Maximum Forward Current vs. Metal Slug Temperature. Derated based on $T_{JMAX} = 125^\circ\text{C}$, $R_{\theta J-MS} = 9^\circ\text{C/W}$.



InGaN

Figure 14: Relative Intensity vs. Wavelength for Cool and Neutral White

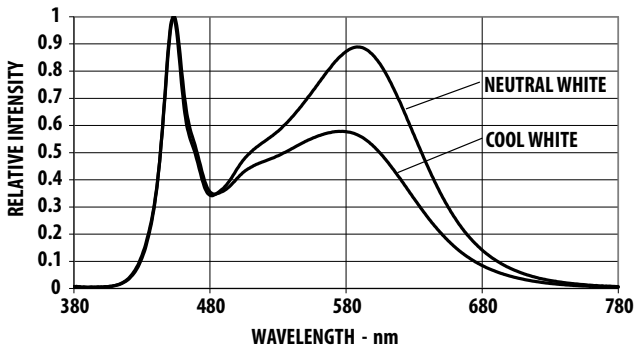

Figure 15: Relative Intensity vs. Wavelength for Blue, Royal Blue, Cyan, and Green

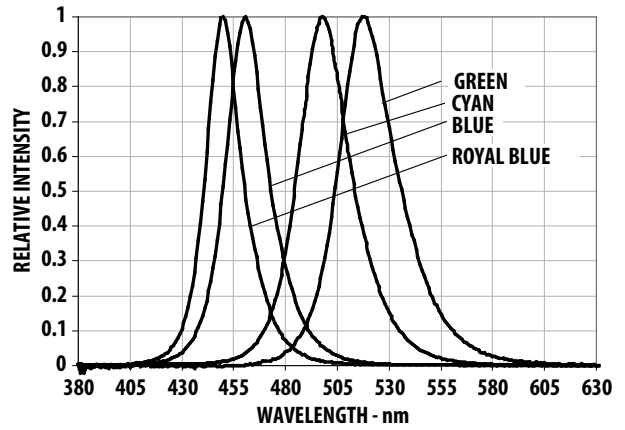

Figure 16: Relative Luminous Flux vs. Mono Pulse Current

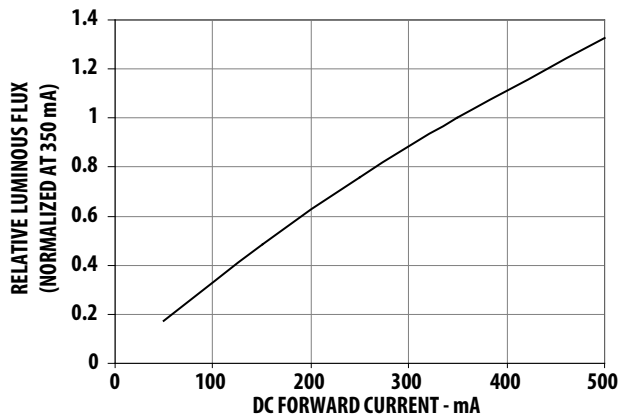

Figure 17: Forward Current vs. Forward Voltage

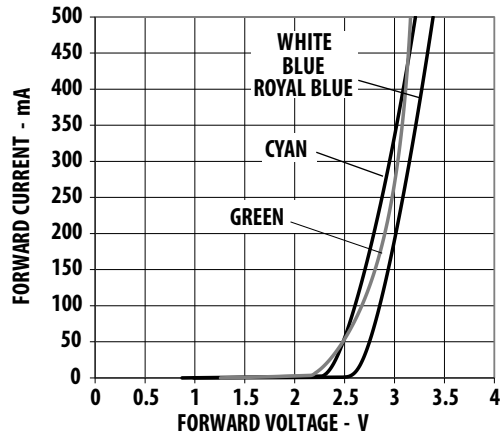

Figure 18: Radiation Pattern for Blue, Royal Blue, Cyan, and Green

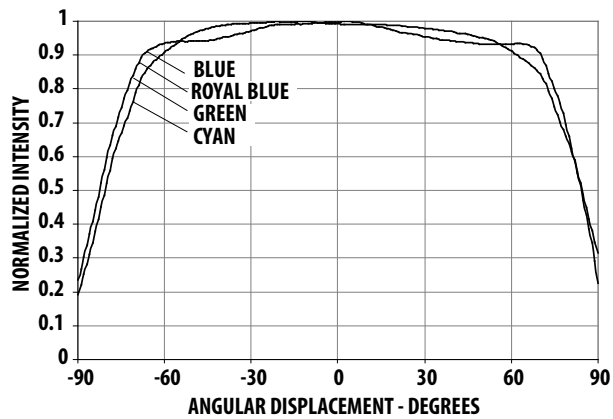
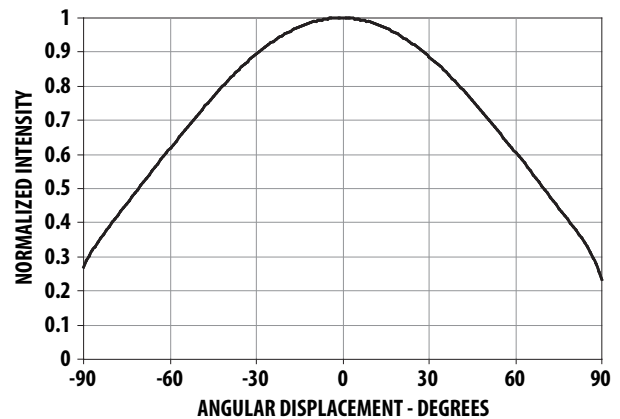

Figure 19: Radiation Pattern for Cool White and Neutral White



InGaN

Figure 20: Maximum Pulse Current vs. Ambient Temperature. Derated based on $T_A = 25^\circ\text{C}$, $R_{\theta J-A} = 50^\circ\text{C/W}$.

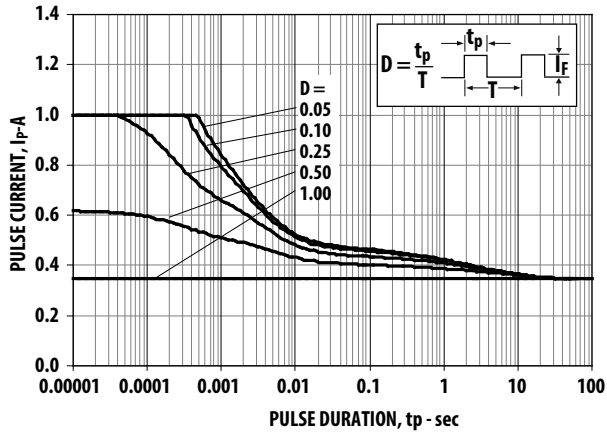

Figure 22: Relative Light Output vs. Junction Temperature

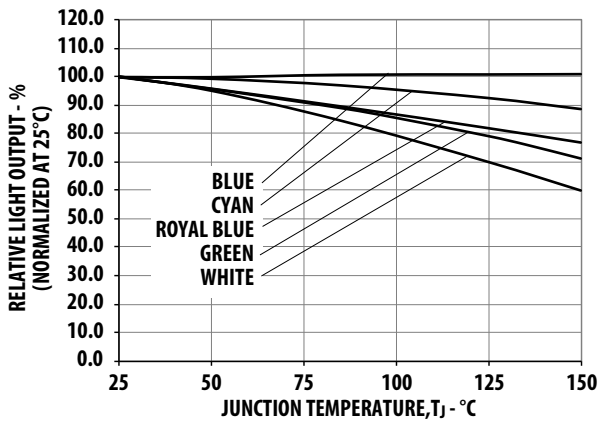

Figure 24: Maximum Forward Current vs. Ambient Temperature. Derated based on $T_{JMAX} = 150^\circ\text{C}$, $R_{\theta J-A} = 30^\circ\text{C/W}$, 40°C/W and 50°C/W .

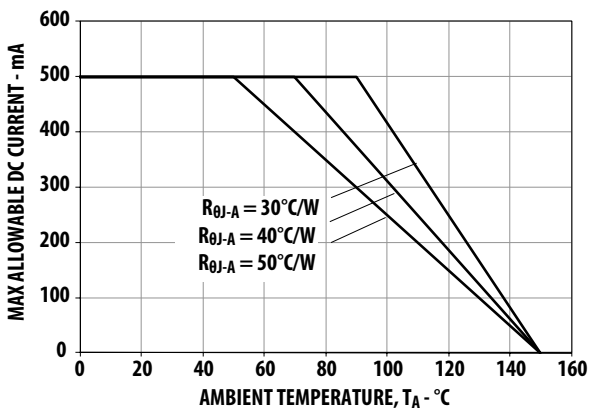

Figure 21: Maximum Pulse Current vs. Ambient Temperature. Derated based on $T_A = 85^\circ\text{C}$, $R_{\theta J-A} = 50^\circ\text{C/W}$.

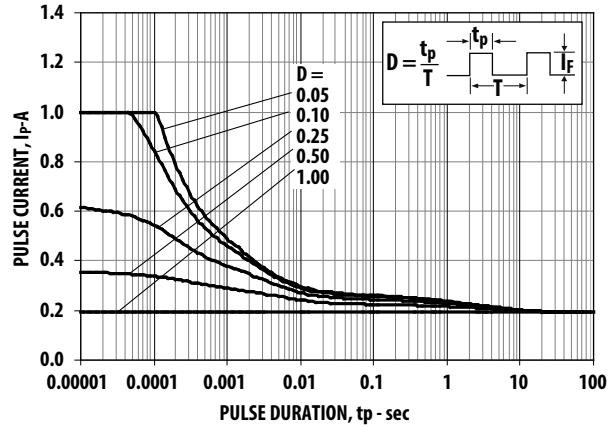

Figure 23: Forward Voltage Shift vs. Junction Temperature

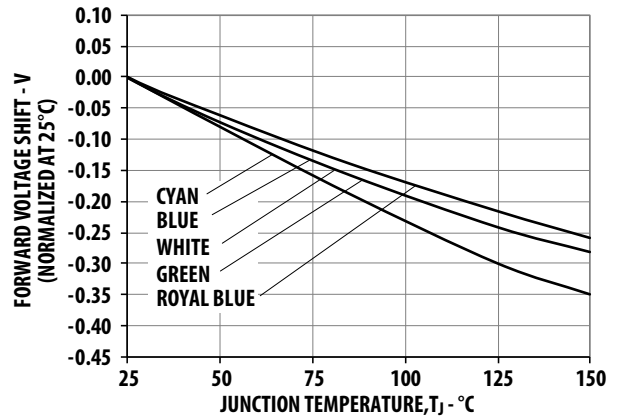

Figure 25: Maximum Forward Current vs. Metal Slug Temperature. Derated based on $T_{JMAX} = 150^\circ\text{C}$, $R_{\theta J-MS} = 9^\circ\text{C/W}$.

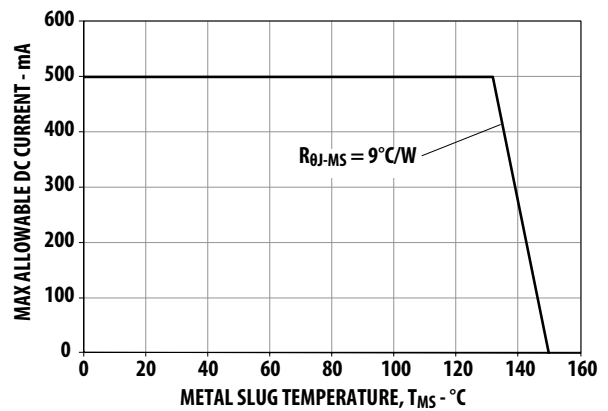

Figure 26: Recommended Soldering Land Pattern

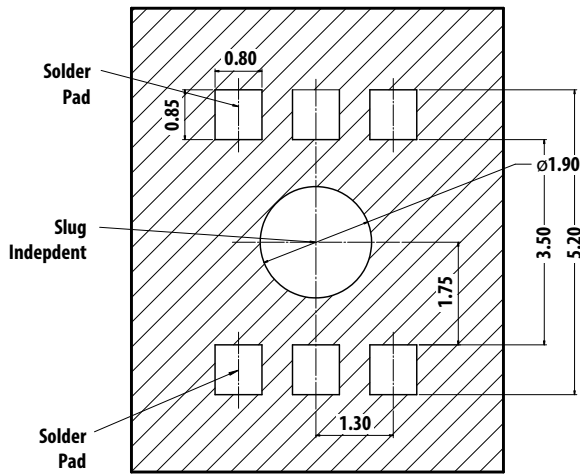

Figure 27: Recommended Pick and Place Nozzle Tip. Inner diameter = 3.2 mm.

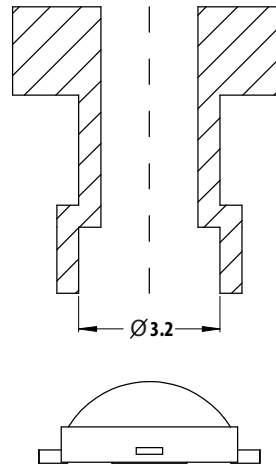
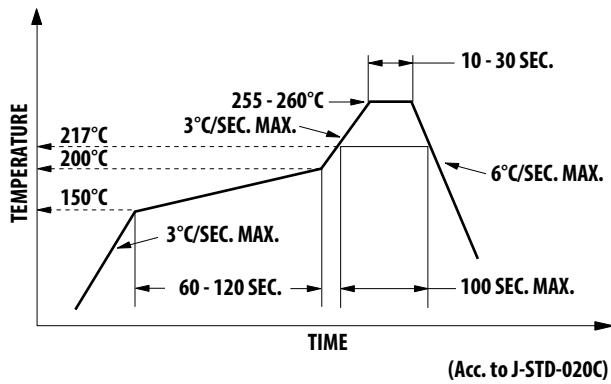

Figure 28: Recommended Soldering Profile



NOTE: For detailed information on reflow soldering of Broadcom surface-mount LEDs, refer to Broadcom Application Note AN1060, *Surface Mounting SMT LED Indicator Components*.

Tape and Reel – Option 1

Figure 29: Carrier Tape Dimensions

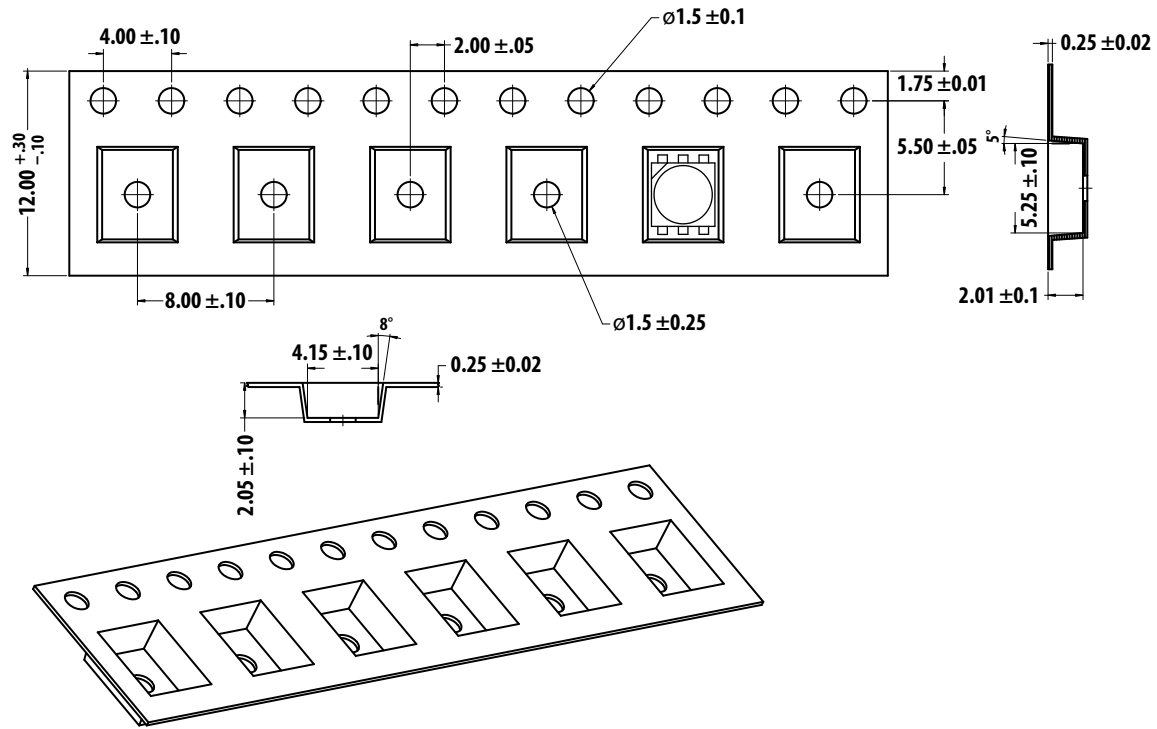

NOTE: All dimensions are in millimeters.

Figure 30: Reel Dimensions

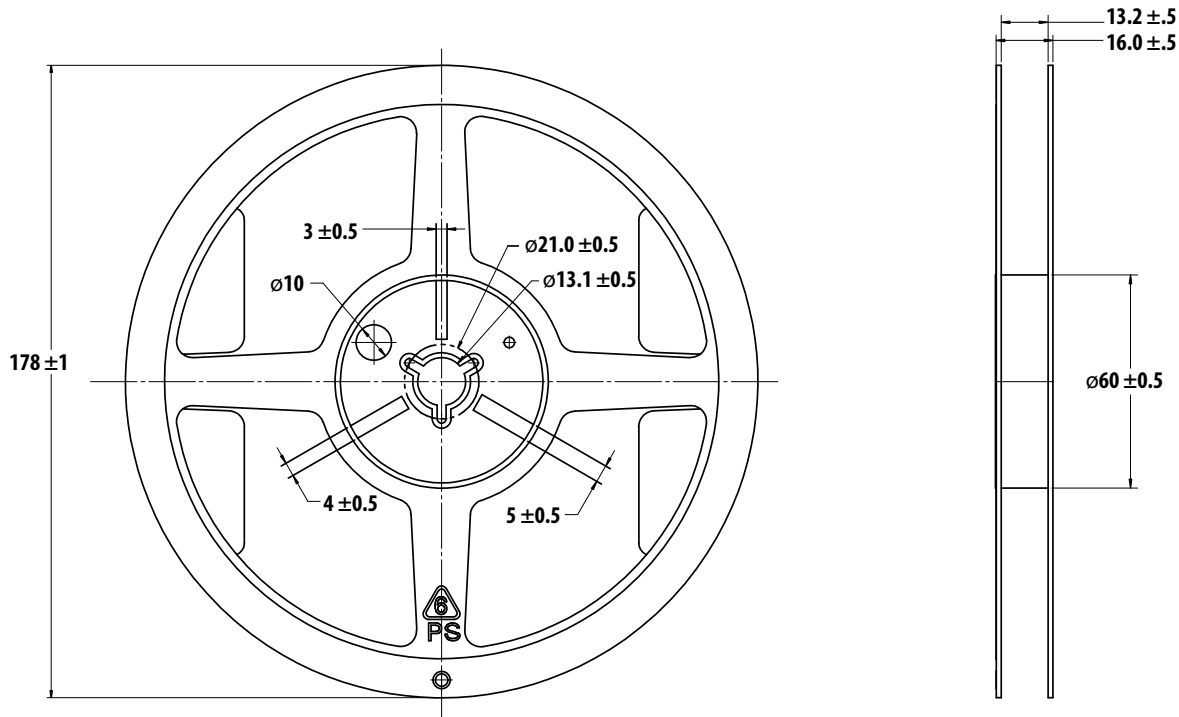

NOTE:

1. Empty component pockets sealed with top cover tape.
2. 250 or 500 pieces per reel.
3. Drawing not to scale.
4. All dimensions are in millimeters.

Figure 31: Reeling Orientation

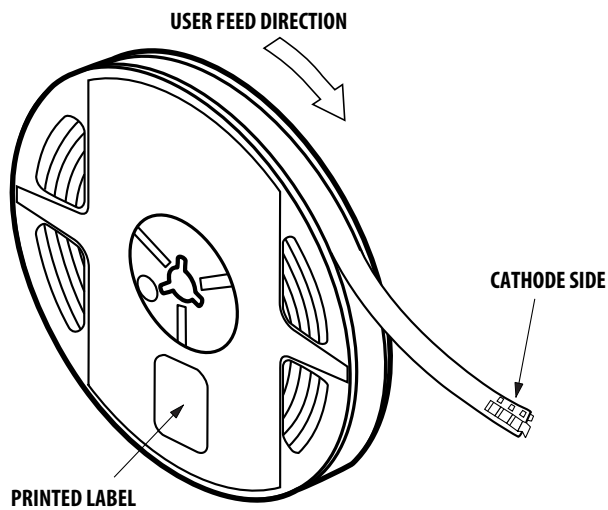

Disclaimer

Broadcom's products and software are not specifically designed, manufactured, or authorized for sale as parts, components, or assemblies for the planning, construction, maintenance, or direct operation of a nuclear facility or for use in medical devices or applications. The customer is solely responsible, and waives all rights to make claims against Broadcom or its suppliers, for all loss, damage, expense, or liability in connection with such use.

Copyright © 2017–2021 Broadcom. All Rights Reserved. The term “Broadcom” refers to Broadcom Inc. and/or its subsidiaries. For more information, go to www.broadcom.com. All trademarks, trade names, service marks, and logos referenced herein belong to their respective companies.

Broadcom reserves the right to make changes without further notice to any products or data herein to improve reliability, function, or design. Information furnished by Broadcom is believed to be accurate and reliable. However, Broadcom does not assume any liability arising out of the application or use of this information, nor the application or use of any product or circuit described herein, neither does it convey any license under its patent rights nor the rights of others.

