

# DCA200DB220

UL:E76102



Same package as the product in this photo.

$V_{RRM} = 2200V$

$I_F(AV) = 200A$

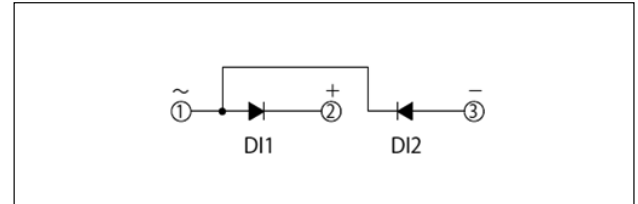

### Features and Advantages

- Provide high VRRM (2200V) by using specially designed glass passivation diode chip.
- Improved heat dissipation thanks to new designed low layered internal structure. Possibility to reduce the heatsink.
- Reduces thermal stress on the diode chip thanks to high heat dissipation internal structure, thus improving the long term reliability.
- 20% weight reduction by optimizing internal design and material.
- Using 100% lead-free solder to protect the environment.

### Applications

- Motor Drives (including Middle voltage Inverter), Battery Charger, Generator

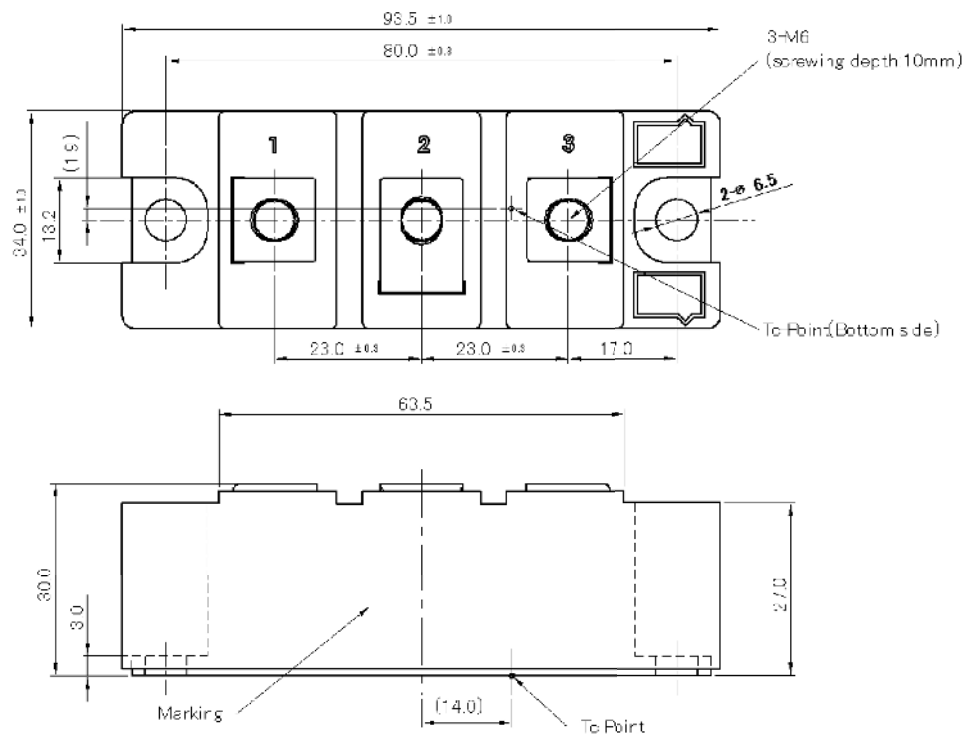

Unit:mm

■ Maximum Ratings (T<sub>j</sub>=25°C unless otherwise specified)

Item	Symbol	Unit	DCA200DB220
Repetitive Peak Reverse Voltage	V <sub>RRM</sub>	V	2200
Non-Repetitive Peak Reverse Voltage	V <sub>RSM</sub>	V	2300

Item	Symbol	Unit	Ratings	Conditions
Average Forward Current	I <sub>F(AV)</sub>	A	200	Sin.180° ,T <sub>c</sub> =110°C
R.M.S. Forward Current	I <sub>F(RMS)</sub>	A	314	Sin.180° ,T <sub>c</sub> =110°C
Surge Forward Current	I <sub>FSM</sub>	A	5000/5500	50/60Hz Sin.Wave,Peak Value,Non-Repetitive
I <sup>2</sup> t (for fusing)	I <sup>2</sup> t	A <sup>2</sup> s	125000	50/60Hz Sin.Wave
Isolation Voltage	V <sub>ISO</sub>	V	2500	AC,RMS,1min
Operating Junction Temperature	T <sub>j</sub>	°C	-40~+150	
Storage Temperature	T <sub>stg</sub>	°C	-40~+125	
Mounting Torque(M6)	-	N·m	4.7	Recommended Value 2.5~3.9 (25~40)
Terminal Torque(M6)	-	(kgf·cm)	4.7	Recommended Value 2.5~3.9 (25~40)
Weight	-	g	180	Typical Value

■ Electrical Characteristics (T<sub>j</sub>=25°C unless otherwise specified)

Item	Symbol	Unit	Ratings			Conditions
			Min.	Typ.	Max.	
Reverse Current	I <sub>R</sub>	mA		5	50	T <sub>j</sub> =T <sub>jmax</sub> ,V <sub>R</sub> =V <sub>RRM</sub> ,Per Leg
Forward Voltage	V <sub>F</sub>	V		1.34	1.4	I <sub>F</sub> =620A,Per Leg
Threshold Voltage	V <sub>(TO)</sub>	V			0.92	T <sub>j</sub> =25°C
					0.76	T <sub>j</sub> =T <sub>jmax</sub>
					0.78	T <sub>j</sub> =25°C
Forward Slope Resistance	r <sub>T</sub>	mΩ			1.08	T <sub>j</sub> =T <sub>jmax</sub>
				0.13	0.15	Junction to Case (Per Leg)
Thermal Resistance	R <sub>th(j-c)</sub>	°C/W		0.065	0.075	Junction to Case (Per Module)
						Case to Fin (Per Module)
		R <sub>th(c-f)</sub>	°C/W			0.10

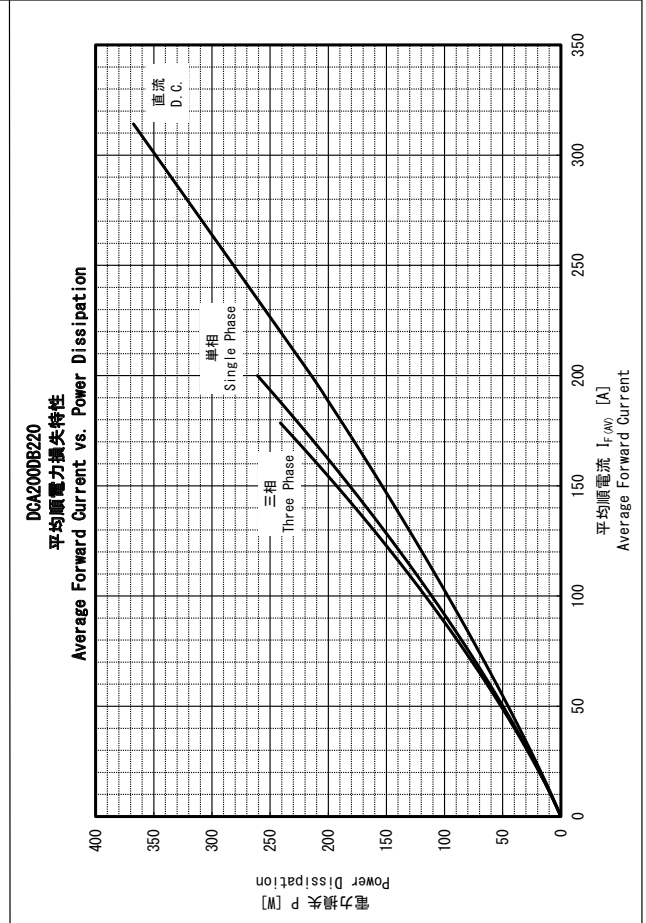
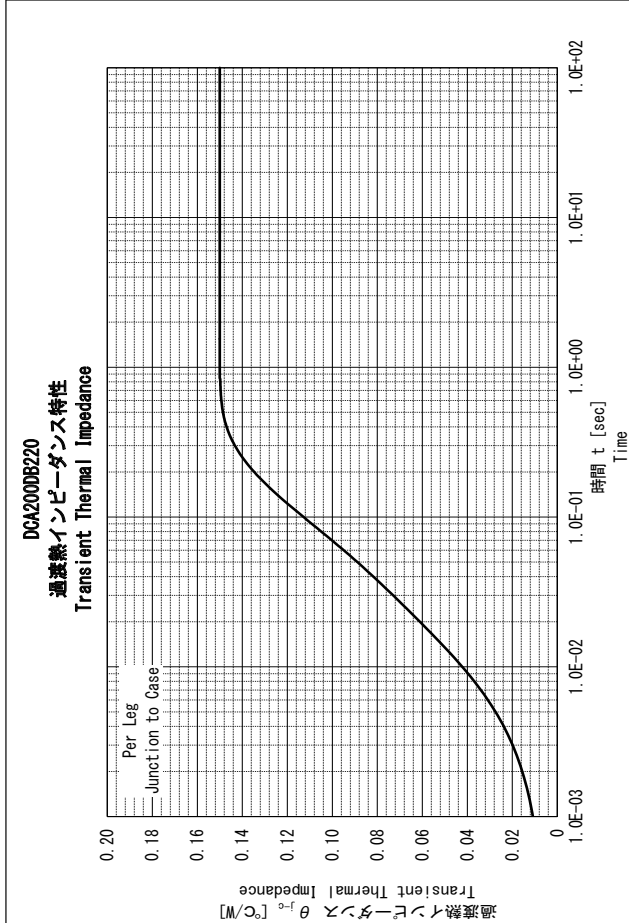
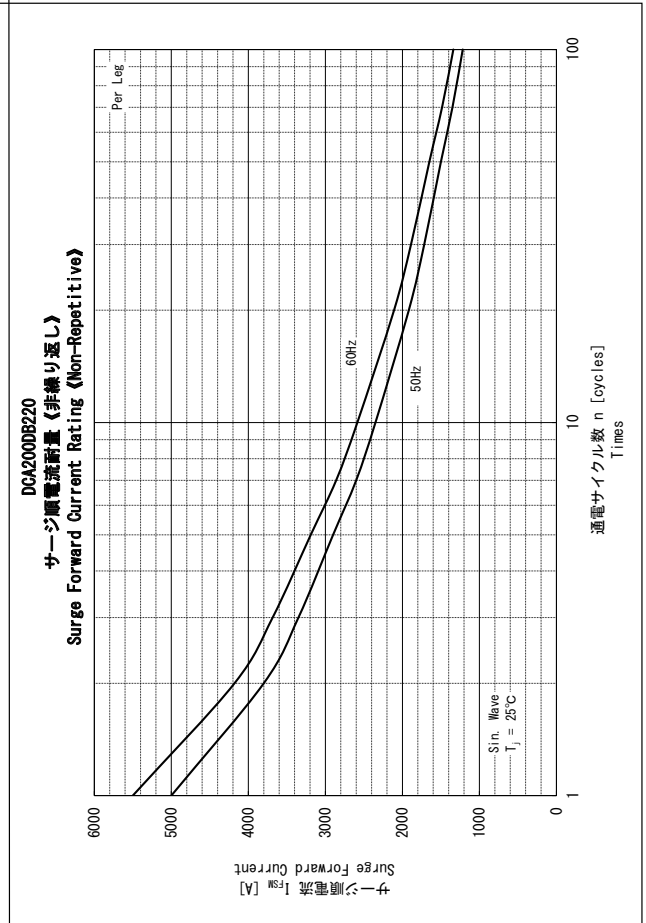
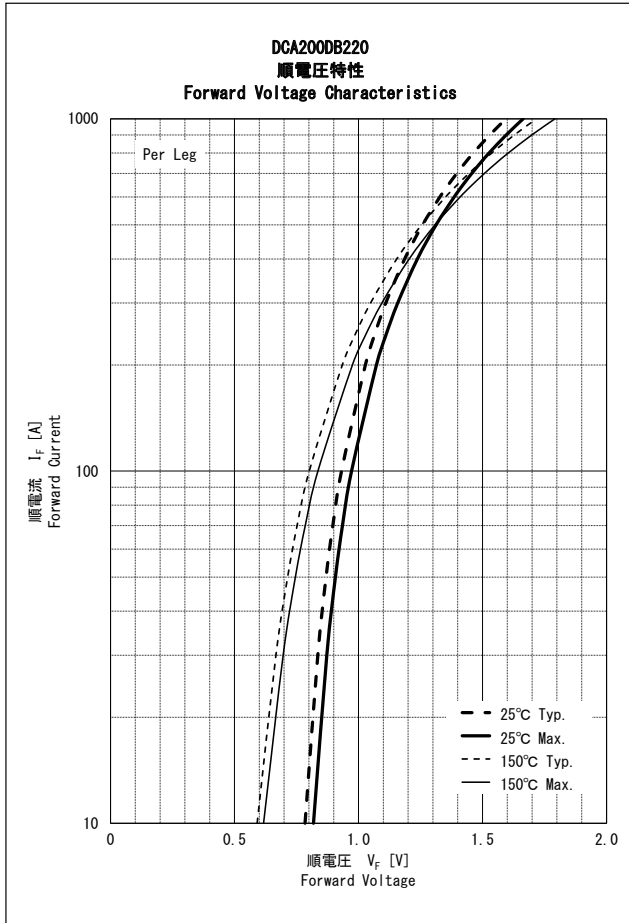

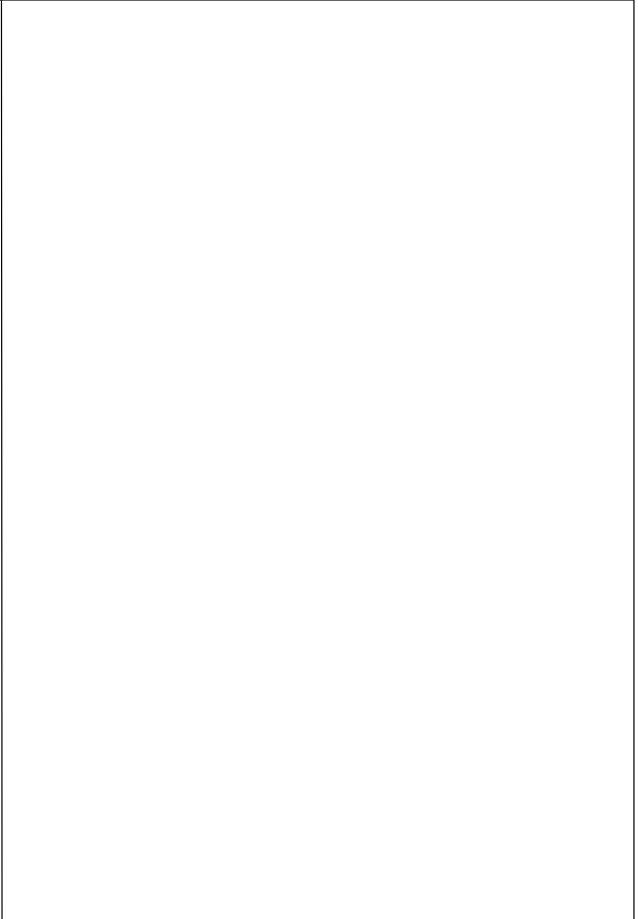
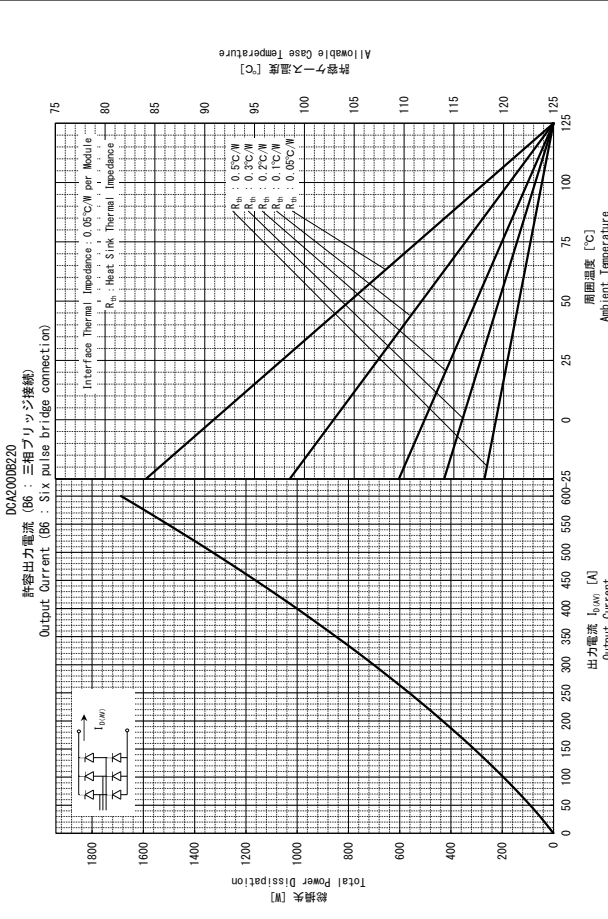
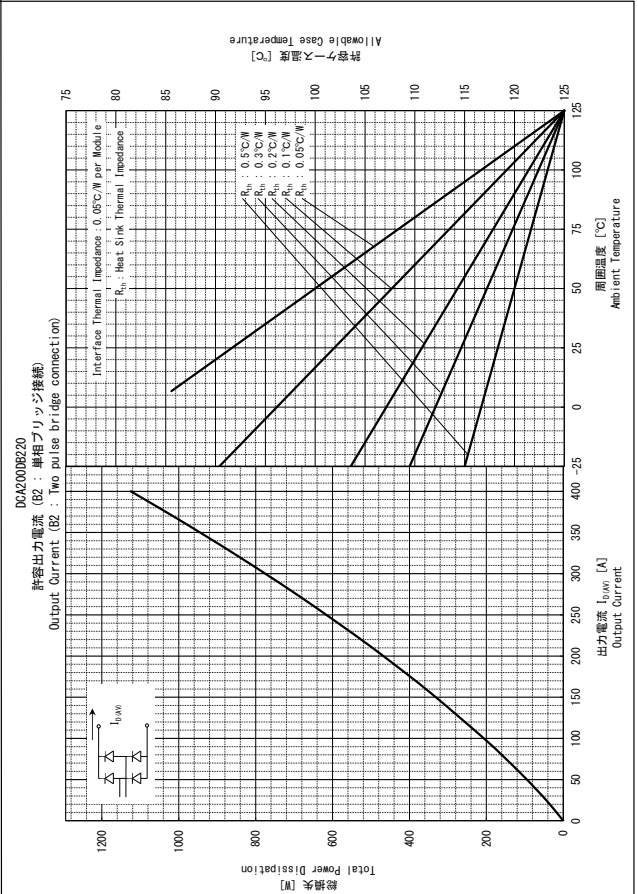
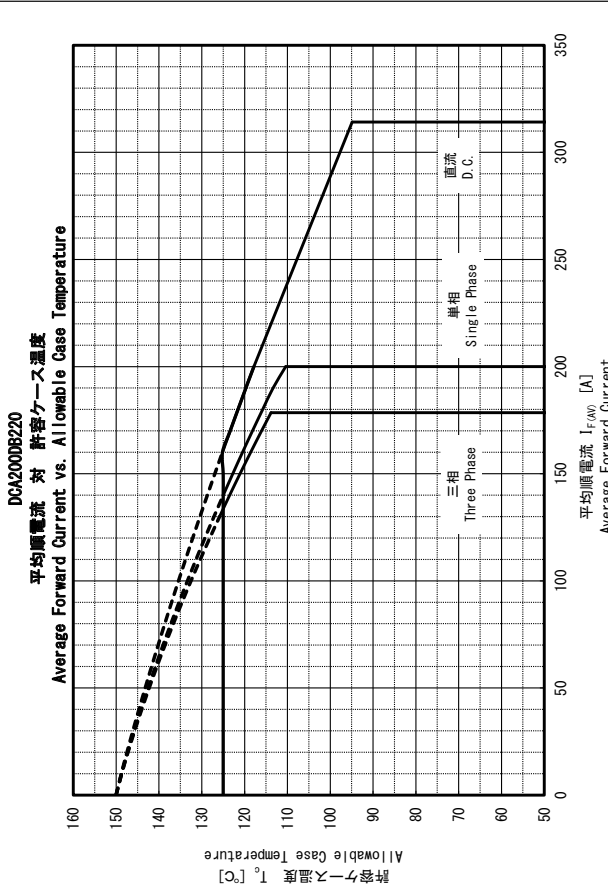

**<Attention>**

- Although we make every effort to improve quality and reliability, semiconductor products may fail or malfunction due to various factors. When using this product, safety measures should be taken for the equipment on which the product will be used, such as redundancy design, design for prevention of the spread of fire, design for prevention of malfunction, etc. in which safety is taken into consideration, so that no accident resulting in personal injury or death, or no damages due to fire, will occur.
- We will not be held responsible for any accidents or damages that have occurred due to use exceeding the rated values or non-observance of precautions.
- If a product described in this material is subject to regulations under the Foreign Exchange and Foreign Trade Act, permission for export is required to be obtained from the Government of Japan under the said Act, in order to export the product.
- Do not use the product for purposes of development, etc. of weapons of mass destruction or for purposes of military utilization, etc.
- Consult us if you have any questions about the product.

**<ご注意>**

- 弊社は品質・信頼性の向上に努めておりますが、半導体製品は様々な要因で故障や誤動作をする場合があります。本製品を使用される場合は、人身事故、火災などによる損害が起こらないようご使用機器での、安全性を考慮した冗長設計、延焼防止設計、誤動作防止設計などの安全措置をとってください。
- 定格を超えるご使用や注意事項を守っていないために生じたいかなる事故や損害に対し、弊社は責任を負うものではありません。
- 本資料に掲載されている製品が、外国為替及び外国貿易法に基づき規制されている場合、輸出には同法に基づく日本国政府の輸出許可が必要です。
- 大量破壊兵器の開発等の目的や、軍事利用等の目的で使用しないでください。
- 製品についてご不明な点は弊社にご照会ください。